

UNDERMOUNT STAINLESS STEEL SINK

Installation & Care Instructions



BEFORE YOU START

- Cahaba recommends that all undermount sinks be installed by an experienced, professional installer.
- **IMPORTANT:** The enclosed cutout template will create a countertop opening with a minimal (1/8" or less) reveal. It is recommended that you discuss this with your installer and agree that this finished appearance is the desired effect. Cahaba is not responsible for improper sink or countertop installations.
- **IMPORTANT:** The cabinet must be installed, secured, plumb, and level. Failure of this step can lead to product damage.
- Cahaba undermount sinks should only be fastened to a solid surface countertop (i.e. granite, Corian® or Silestone®).
- Cahaba is not responsible for sink or countertop if damaged during installation. Be sure to inspect the sink for damage prior to beginning installation.
- Metal edges may be sharp – use caution when handling.
- Follow all local plumbing and building codes.

FOR MODEL NUMBER

CA122129

RECOMMENDED TOOLS

- Tape Measure
- Safety Glasses
- Painter's Tape
- Level
- Framing Square
- Pencil (not permanent marker)
- Shims or Cabinet Fillers
- Denatured Alcohol
- Clamps
- Construction Adhesive
- Silicone Sealant
- Screws (recommended by countertop manufacturer)

UNDERMOUNT STAINLESS STEEL SINK
Specifications

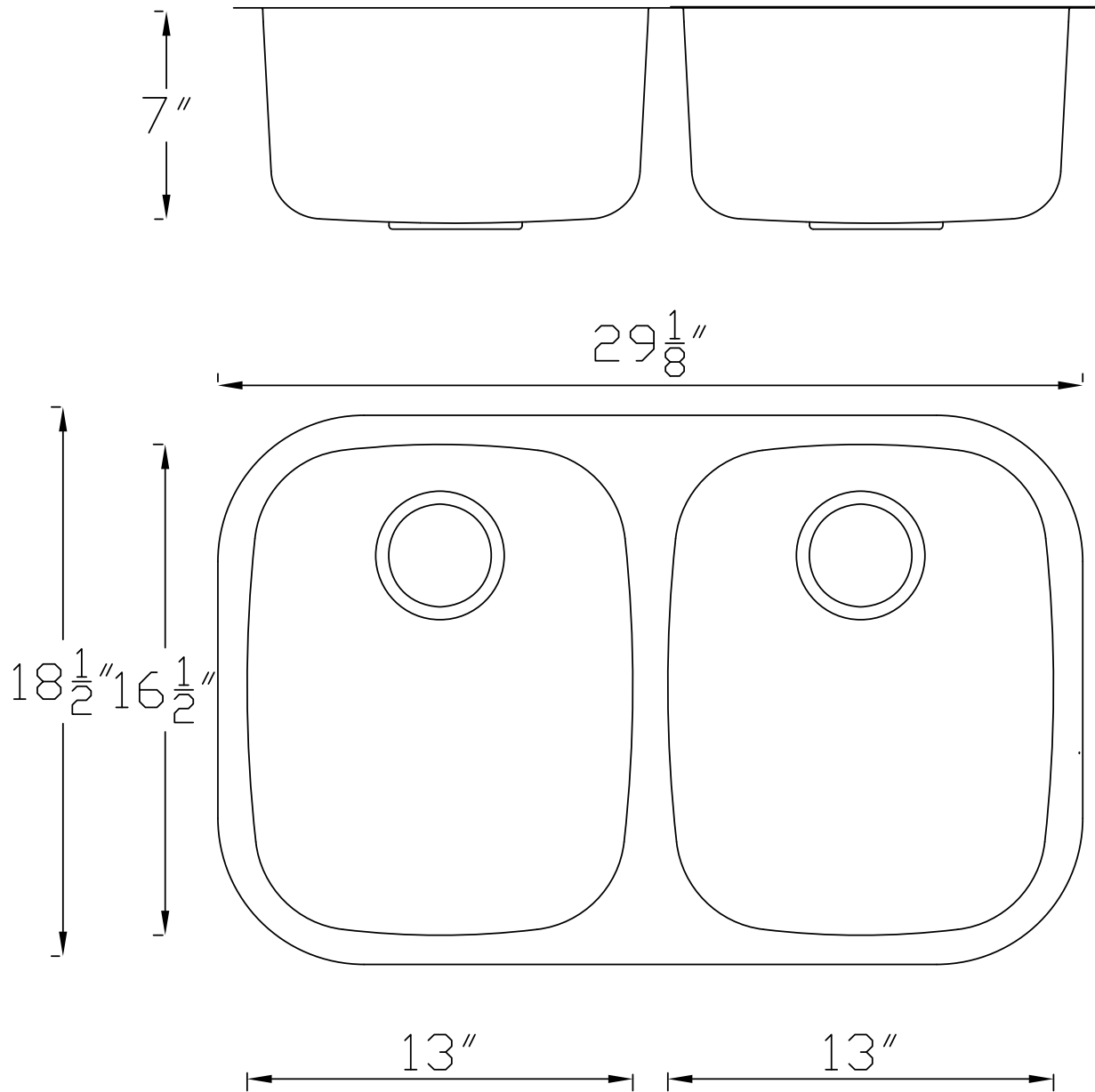

UNDERMOUNT STAINLESS STEEL SINK

Installation Instructions



PREPARE THE COUNTERTOP

1. Position the template (provided with your sink) front to rear so the sink will not interfere with the cabinet; secure with tape.
2. Trace the template and remove. Dry fit the sink to verify the measurements.
3. Following the countertop manufacturer's instructions, carefully cut the countertop on the inside of the traced line.
4. Locate and drill the mounting holes, following the countertop manufacturer's instructions. Holes should allow even spacing of mounting brackets around the sink.
5. With the countertop inverted (upside down), fasten the mounting

▶ **IMPORTANT:** *The cabinet must be installed, secured, plumb, and level BEFORE installing the sink.*

▶ **IMPORTANT:** *Cahaba undermount sinks should only be fastened to a solid surface countertop (i.e. granite, Corian® or Silestone®).*

OUTLINE FOR UNDERMOUNT SINK CUTOUT

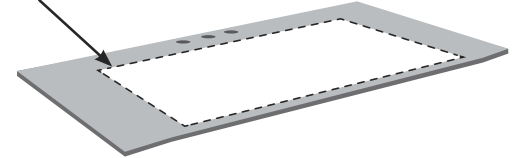

MOUNTING BRACKET FASTENER

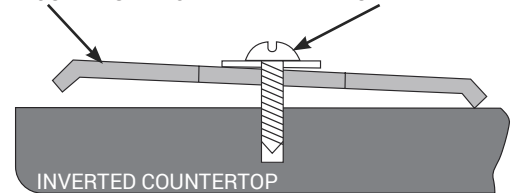

INSTALL THE COUNTERTOP

1. Clean the bottom of the countertop and the top flange (or lip) of the sink with denatured alcohol.
2. Apply a narrow bead of silicone adhesive sealant evenly all around the top of the sink flanges.
3. Position and align the sink over the countertop opening. Press silicone onto countertop.
4. Tighten fasteners until mounting brackets are snug against sink. Check alignment of sink to the countertop opening.
5. Tighten down fasteners evenly. Be careful not to over-tighten.
6. Immediately remove excess sealant.

▶ **IMPORTANT:** *The enclosed cutout template will create a countertop opening with a minimal (1/8" or less) reveal. It is recommended that you discuss this with your installer and agree that this finished appearance is the desired effect. Cahaba is not responsible for improper sink or countertop installations.*

▶ **IMPORTANT:** *Cahaba is not responsible for sink or countertop if damaged during installation. Be sure to inspect the sink for damage prior to beginning installation.*

APPLY SILICONE SEALANT AFTER CLEANING THE SINK EDGE AND COUNTERTOP

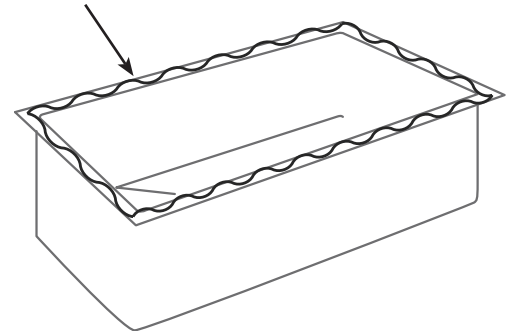

VERIFY SINK IS CENTERED WITHIN THE COUNTERTOP OPENING BEFORE TIGHTENING FASTENERS.

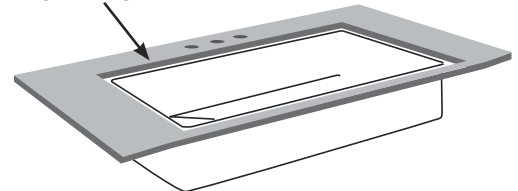

UNDERMOUNT STAINLESS STEEL SINK

Care & Maintenance Instructions



RECOMMENDED CLEANERS

- ▶ For stains or light scratches, we suggest a mildly aggressive cleaner. You can also try a paste of baking soda and water, but be sure to rinse well and dry.
- ▶ For stubborn stains and more noticeable scratches, we suggest a more aggressive cleaner such as Bar Keeper's Friend®. For extremely stubborn stains, you may also try to use a Scotch-Brite™ Pad.
- ▶ When using any of these cleaners, it is critical that you rub in the direction of the grain lines of the sink, rinse completely and towel dry.

SUGGESTED MAINTENANCE

- ▶ Rinse thoroughly after each use. Most soaps and detergents contain chlorides that are harsh on stainless steel. The good news is that chlorides are highly water soluble so a thorough rinsing of your sink after each use and weekly cleaning will keep your sink looking bright and shiny.
- ▶ Towel dry after each use to prevent mineral deposits from building upon the surface of the sink. Water quality can affect the appearance of your sink. Towel drying and weekly cleaning will prevent discoloration or unsightly film from developing on the finish.
- ▶ Always use the Cahaba sink bottom grid to protect your sinks finish.
- ▶ Clean the sink once a week. Be sure to rub in the direction of the satin finish lines, using a Cahaba recommended cleanser.
- ▶ For a gleaming finish: Polish your stainless steel sink by applying dry flour to the surface. Rub the flour in with a soft cloth, then rinse and dry or place the stopper in your sink, pour some club soda in and rub with a soft cloth. Dry with a different soft cloth to prevent water spots and surface rust.

CAUTION

- ▶ Don't rub the sink across the satin finish lines. Scouring across the satin finish lines can damage the original sink finish.
- ▶ Don't allow soap or other household cleansers to dry on the surface of the sink. Most brands contain chemical additives which will affect the original finish.
- ▶ Don't use solutions of chlorine bleach and water in the sink. Chlorides, which are found in most soaps, detergents, bleaches, and cleansers, are very aggressive to stainless steel. If left on the sink too long, they can cause surface pitting.
- ▶ Don't leave wet sponges, cloths, or cleaning pads on the sink. This can lead to surface rust.
- ▶ Don't use a steel wool pad to clean your sink. If a more abrasive product is needed, use a green Scotch-Brite™ pad, being sure to rub in the direction of the satin finish lines. Steel wool pads have a tendency to break apart and small particles of steel can become embedded in the surface of the sink. The steel particles will rust and will give the appearance that the sink itself is rusting.
- ▶ Don't use rubber mats or dishpans in the sink. Leaving rubber mats or dishpans in the sink can lead to surface rust or possible pitting. However, if you insist on using mats or dishpans, please remove them after each use and rinse thoroughly.

LIMITED LIFETIME WARRANTY



This product has been manufactured and tested to the highest quality standards by Cahaba. We offer our customers thoughtfully crafted fixtures & accessories, engineered for enduring performance over years of use.

WHO IS COVERED BY THE WARRANTY

This warranty extends to the original purchaser only. This warranty is not transferable, between homes or owners and is only applicable to residential use.

WHAT IS COVERED BY THE WARRANTY

Cahaba warranties this product against defects due to material or craftsmanship error during the warranty period: Cahaba will provide replacement parts at no charge, or at its option, replace any product or part of the product that is deemed defective, under normal installation, use, service and maintenance. If Cahaba is unable to provide a replacement and repair is not practical or cannot be made in timely fashion, Cahaba may elect to refund the purchase price in exchange for the return of the product.

CONDITIONS AND EXCLUSIONS

Like other home fixtures, Cahaba products will require light maintenance to ensure proper function. We provide you with complete knowledge to perform this maintenance and can also recommend resources if you are unable to fulfill this service.

- A. Cahaba will not be responsible for product failures due to lack of maintenance or proper use. Please read your care and maintenance documentation to determine the limits of proper use.
- B. The original sales receipt, order number, and/or proof of purchase must be presented at the time of the warranty claim, without exception, for this warranty to be applied to all Cahaba products.
- C. Cahaba recommends installing all Cahaba products with a licensed, professional plumber. Cahaba will not be held responsible for any damage or product failure due to improper installation, misuse, or failure to use a licensed professional. Please read your care and maintenance documentation to determine the limits of proper use.
- D. Commercial use will automatically void this warranty.

NON-APPLICABILITY OF THIS WARRANTY

By the purchase and use of our products, you agree that Cahaba is not liable for incidental, consequential or special damages associated with the return, replacement, installation or use of your product. This includes freight costs, cartridge replacement, labor, travel time, lost profit, home damages and other contingent liabilities and costs (including, without limitation, costs associated with experts, investigations, analyses, attorneys and other professionals and services).

The Cahaba warranty is a comprehensive and explicit limit of liability and all items outside of it are not addressable by or the responsibility of Cahaba. Certain states have variances regarding implied warranties and in those situations we remain fully compliant. Cahaba makes no implication that products comply with any or all local building or plumbing codes. It is the consumer's responsibility to determine local code compliance. This warranty extends to the original purchaser and first consumer.