

# INSTALLATION

## Installation Overview

Please read the following installation instructions first after purchasing this product or transporting it to another location.

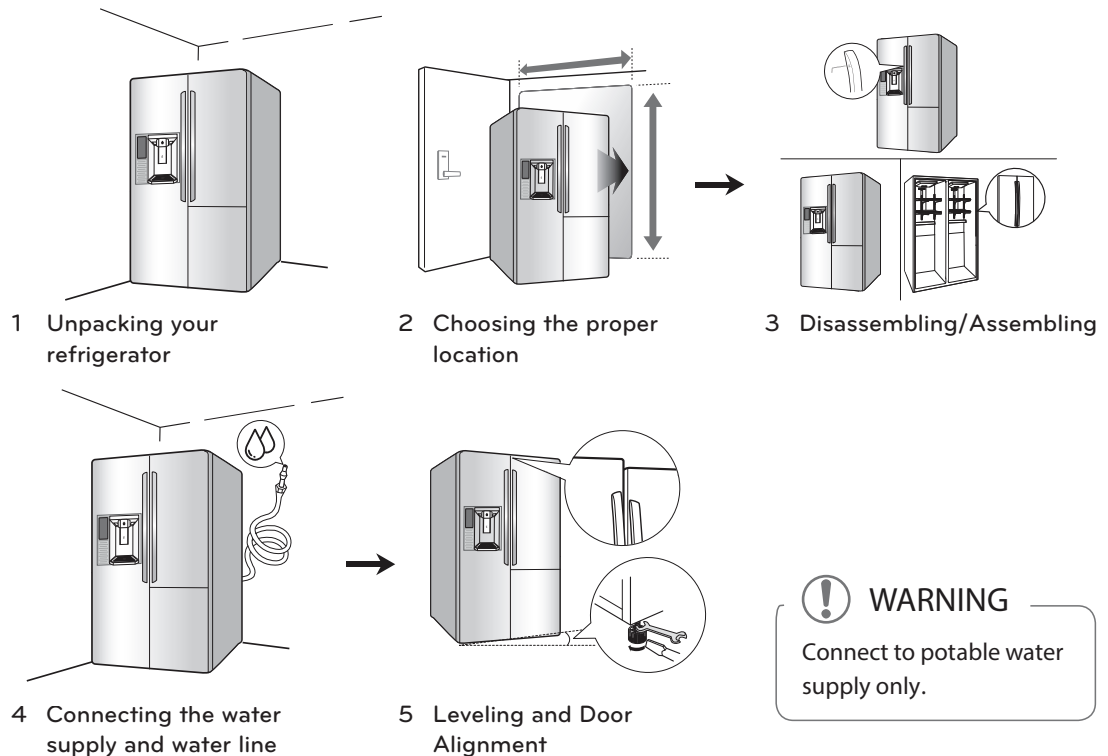

## Specifications

The appearance and specifications listed in this manual may vary due to constant product improvements.

Side by Side refrigerator model	
Description	Side by Side refrigerator
Electrical requirements	115 V ~ 60 Hz and fused at 15 A 127 V ~ 60 Hz and fused at 15 A 220 V ~ 50/60 Hz and fused at 10 A (Refer to rating label inside refrigerator compartment).
Min. / Max. Water pressure	20 - 120 psi (138 - 827 kPa) on models without water filter 40 - 120 psi (276 - 827 kPa) on models with filter
Dimensions for Standard Depth Models LSXS26****, GS7****	35.9" (W) X 35.9" (D) X 70.3" (H), 50.6" (D w/ door open) 912 mm (W) X 912 mm (D) X 1785 mm (H), 1286 mm (D w/ door open) After Door Removal: 28.7" (730 mm) (D)
Dimensions for Counter Depth Models LSXC22****	35.9" (W) X 31.9" (D) X 70.3" (H), 46.7" (D w/ door open) 912 mm (W) X 811 mm (D) X 1785 mm (H), 1185 mm (D w/ door open) After Door Removal: 24.6" (624 mm) (D)
Net weight for Standard Depth Models LSXS26****, GS7****	DID Model: 304.3 lb (138 kg) Basic Model Vertical: 277.8 lb (126 kg) Basic Model Horizontal: 264.6 lb (120 kg)
Net weight for Counter Depth Models LSXC22****	DID Model: 277.8 lb (126 kg) Non DID Model: 251.4 lb (114 kg)

## Unpacking Your Refrigerator



### WARNING

- Use two or more people to move and install the refrigerator. Failure to do so can result in back or other injury.
- Your refrigerator is heavy. When moving the refrigerator for cleaning or service, be sure to protect the floor. Always pull the refrigerator straight out when moving it. Do not wiggle or walk the refrigerator when trying to move it, as floor damage could occur.
- Keep flammable materials and vapors, such as gasoline, away from the refrigerator. Failure to do so can result in fire, explosion, or death.

Remove tape and any temporary labels from your refrigerator before using. Do not remove any warning-type labels, the model and serial number label .

To remove any remaining tape or glue, rub the area briskly with your thumb. Tape or glue residue can also be easily removed by rubbing a small amount of liquid dish soap over the adhesive with your fingers. Wipe with warm water and dry.

Do not use sharp instruments, rubbing alcohol, flammable fluids, or abrasive cleaners to remove tape or glue. These products can damage the surface of your refrigerator.

Refrigerator shelves are installed in the shipping position. Please reinstall shelves according to your individual storage needs.

## Choosing the Proper Location

- Select a place where a water supply can be easily connected for the automatic icemaker.



### NOTE

The water pressure must be between 20 and 120 psi (138 and 827 kPa) on models without a water filter and between 40 and 120 psi (276 and 827 kPa) on models with a water filter.

- The refrigerator should always be plugged into its own individual properly grounded electrical outlet. This provides the best performance and also prevents overloading house wiring circuits which could cause a fire hazard from overheated wires. It is recommended that a separate circuit serving only this appliance be provided.



### WARNING

To reduce the risk of electric shock, do not install the refrigerator in a wet or damp area.

## Flooring

To avoid noise and vibration, the unit must be leveled and installed on a solidly constructed floor. If required, adjust the leveling legs to compensate for unevenness of the floor. The front should be slightly higher than the rear to aid in door closing. Leveling legs can be turned easily by tipping the cabinet slightly. Turn the leveling legs to the left to raise the unit or to the right to lower it. (See Leveling and Door Alignment.)



### NOTE

Installing on carpeting, soft tile surfaces, a platform or weakly supported structure is not recommended.

## Ambient Temperature

Install this appliance in an area where the temperature is between 55°F (13°C) and 110°F (43°C). If the temperature around the appliance is too low or high, cooling ability may be adversely affected.

## Measuring the Clearances

Too small of a distance from adjacent items may result in lowered freezing capability and increased electricity consumption charges. Allow at least 24 inches (61 cm) in front of the refrigerator to open the doors, and at least 2 inches (5.08 cm) between the back of the refrigerator and the wall as well as on the sides of the refrigerator and adjacent walls or objects.

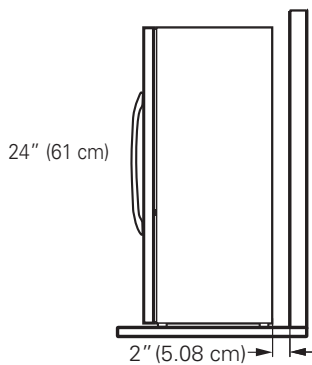

## Removing/Assembling the Refrigerator Door Handles

### NOTE

When it is necessary to move the refrigerator through a narrow opening, removing the doors is the recommended procedure. If it is necessary to remove the handles, follow the directions below. The appearance of the handle may vary from what is shown in the illustrations

### Removing the Handles

- 1 Loosen the set screws with a 3/32 in. Allen wrench and remove the handle.
- 2 Loosen the mounting fasteners that connect to the refrigerator door and handle using a 1/4 in. Allen wrench, remove the mounting fasteners.

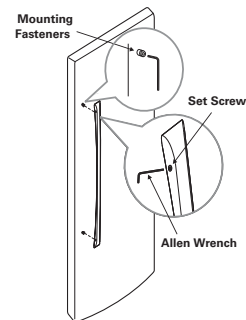

### Assembling the Handles

- 1 Assemble the mounting fasteners at both ends of the handle using a 1/4 in. Allen wrench.
- 2 Place the handle on the door by fitting the handle footprints over the mounting fasteners and tightening the set screws with a 3/32 in. Allen wrench.

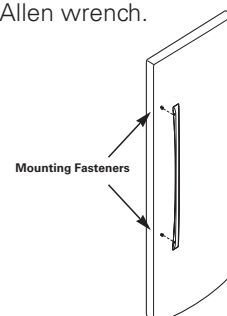

## Removing/Assembling the Refrigerator Doors

When it is necessary to move the refrigerator through a narrow opening, removing the doors is the recommended procedure.

### WARNING

#### Electric Shock Hazard

**Disconnect electrical supply to refrigerator before installing.** Failure to do so could result in death or serious injury.

Before removing freezer door, disconnect water line connectors (one white tube, one blue tube).

NOTE: Do not remove freezer door if either the white or blue tube is still connected. To remove connectors use the support block that is on the upper shelf in the refrigerator.

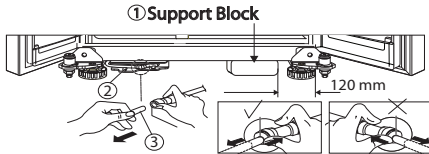

- If your entrance door is too narrow for the refrigerator to pass through, remove the refrigerator doors and move the refrigerator sideways through the doorway. Use two or more people to remove and install the refrigerator doors. Failure to do so can result in back or other injury.
- Disconnect the electrical supply to the refrigerator before installation. Failure to do so could result in serious injury or death.
- Do not put hands, feet or other objects into the air vents or bottom of the refrigerator. You may be injured or receive an electrical shock.
- Be careful when handling the hinge and stopper. You may be injured.
- Remove food and bins before detaching the doors and drawers.

## Removing the Left (Freezer) Door with Water Line Connection

1. Loosen the hinge cover screws and remove the hinge cover. Disconnect all wire harnesses.

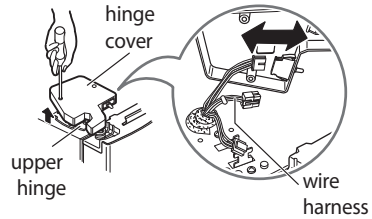

2. Rotate the hinge lever counterclockwise (1) and lift the upper hinge (2).

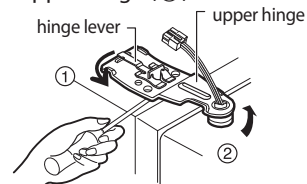

### CAUTION

When removing the upper hinge, be careful that the door does not fall forward.

3. Remove the freezer compartment door by lifting it upward. This time, the door should be lifted enough for the water feed tube to be completely pulled out.

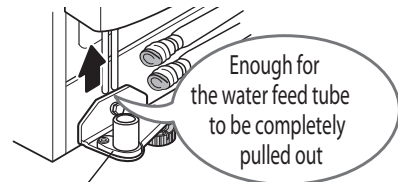

### CAUTION

Place the door, inside facing up, on a non-scratching surface. Be careful not to damage the water feed tube.

## Removing the Right (Refrigerator) Door

1. Open the door. Remove the top hinge cover screw.
2. Use a flat blade screwdriver to pry back the hooks (not shown) of the hinge cover from the top of the refrigerator cabinet. Lift up the cover. Disconnect all wire harnesses.

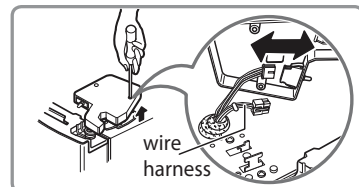

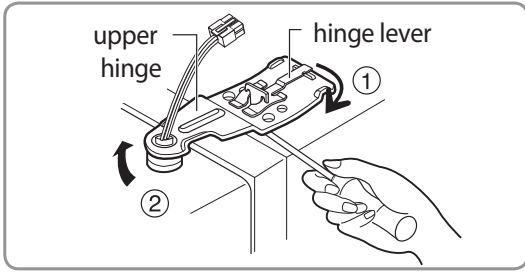

3. Rotate the hinge lever clockwise (1). Lift the upper hinge free of the hinge lever latch (2).



**CAUTION**

When lifting the hinge free of the latch, be careful that the door does not fall forward.

4. Lift the door from the lower hinge pin.

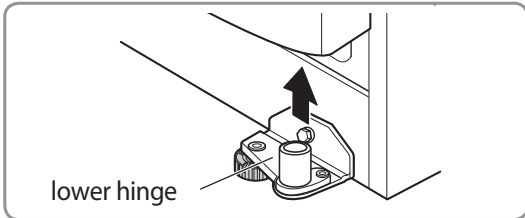

5. Place the door, inside facing up, on a non-scratching surface.



**NOTE**

- Do not remove the grease on the surface of the gasket or hinge.
- Do not remove the sensor assembly in the right upper hinge cover.

**Reinstalling the Right (Refrigerator) Door**

1. Place the door onto the lower hinge pin.
2. Fit the upper hinge over the hinge lever latch and into place. Rotate the lever counterclockwise to secure the hinge.
3. Reconnect all wire harnesses. Hook the tab on the switch side of the cover under the edge of the wire opening in the cabinet top. Position the cover and replace the screw.

**Reinstalling the Left (Freezer) Door**

1. Feed the water tubes through the lower hinge pin and place the door onto the lower hinge pin. Water hoses should be behind the leg to prevent damage.

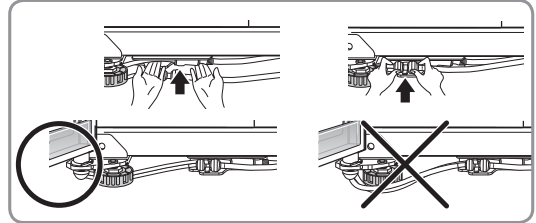

2. Fit the top hinge over hinge lever latch and into place. Rotate the lever clockwise to secure the hinge.
3. Install the grounding screw and connect all the wire harnesses.
4. Hook the tab on the door switch side of the cover, under the edge of the wire, opening in the cabinet top. Position the cover into place. Insert and tighten the cover screw.
5. Reconnect the water tubes by inserting the tubes into the connectors. The tube is inserted correctly when only one guide line is showing out of two.

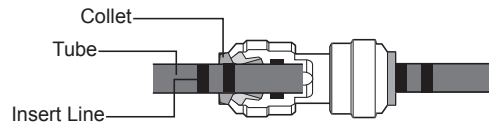

Open the door and turn the hose toward the inside. Water hoses should be behind the leg to prevent damage.

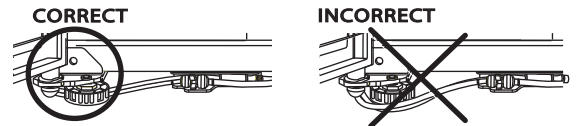

Tube is completely inserted when only one guide line is showing out of two.

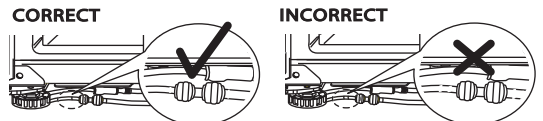

Water hoses should be cut with a clean, straight edge to avoid leaks.





## Connecting the Water Line

### Before You Begin

This water line installation is not covered by the refrigerator warranty. Follow these instructions carefully to minimize the risk of expensive water damage.

Water hammer (water banging in the pipes) in house plumbing can cause damage to refrigerator parts and can lead to water leakage or flooding. Call a qualified plumber to correct water hammer before installing the water supply line to the refrigerator.

 **CAUTION**  
To prevent burns and product damage, only connect the refrigerator water line to a cold water supply.

 **CAUTION**  
Do not install the icemaker tubing in areas where temperatures fall below freezing.

### Water Pressure

You will need a cold water supply. The water pressure must be between 20 and 120 psi ( 138 – 827 kPa ) on models without a water filter and between 40 and 120 psi ( 276 – 827 kPa ) on models with a water filter. If the water pressure does not reach the minimum required pressure, a separate booster pump may be required for normal automatic icemaker and cool water dispensing operation.

If a reverse osmosis water filtration system is connected to your cold water supply, this water line installation is not covered by the refrigerator warranty. Follow these instructions carefully to minimize the risk of expensive water damage.

If a reverse osmosis water filtration system is connected to your cold water supply, the water pressure to the reverse osmosis system needs to be a minimum of 40 to 60 psi (276 - 413 kPa, or less than 2.0~3.0 sec. to fill a cup of 7 oz capacity).



### CAUTION

Wear eye protection during installation to prevent injury.

If the water pressure from the reverse osmosis system is less than 21 psi or 1.5 kgf/cm<sup>2</sup> (takes more than 4.0 sec to fill a cup of 7 oz capacity):

- Check to see if the sediment filter in the reverse osmosis system is blocked. Replace the filter if necessary.
- Allow the storage tank on the reverse osmosis system to refill after heavy usage.
- If the issue concerning water pressure from reverse osmosis remains, call a licensed, qualified plumber.
- All installations must be in accordance with local plumbing code requirements.

### What You Will Need

- **Copper Tubing**, ¼ in. outer diameter, to connect the refrigerator to the water supply. Be sure both ends of the tubing are cut square.

To determine how much tubing you need: measure the distance from the

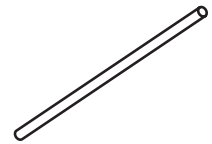

water valve on the back of the refrigerator to the water supply pipe. Then, add 8 feet (2.4 m). Be sure there is sufficient extra tubing (about 8 feet [2.4 m] coiled into 3 turns of about 10 in. [25 cm] diameter) to allow the refrigerator to move out from the wall after installation. Keep the total length of the feed water pipe tube within 26 ft (8 m). Be careful to avoid getting a kink in the tube. If the tube is longer than 26 ft (8 m), it may cause the water feed to malfunction.

- **Power drill.**
- **½ in. or adjustable wrench.**
- **Flat blade and Phillips head screwdrivers.**
- **Two ¼ in. outer diameter compression nuts and 2 ferrules (sleeves)** to connect the copper tubing to the shutoff valve and the refrigerator water valve.

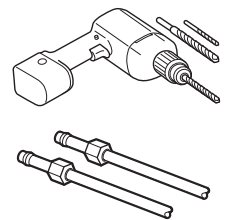

- If your existing copper water line has a flared fitting at the end, you will need an **adapter** (available at plumbing supply stores) to connect the water line to the refrigerator OR you can cut off the flared fitting with a tube cutter and then use a compression fitting.

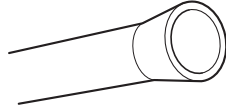

- **Shutoff valve to connect to the cold water line.** The shutoff valve should have a water inlet with a minimum inside diameter of 5/32 in. at the point of connection to the COLD WATER LINE. Saddle-type shutoff valves are included in many water supply kits.

Before purchasing, make sure a saddle-type valve complies with your local plumbing codes.

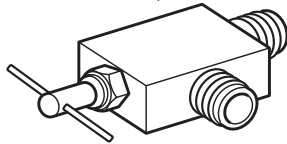
**NOTE**

A self-piercing saddle type water valve should not be used.

**WARNING****Electrical Shock Hazard:**

When using any electrical device (such as a power drill) during installation, be sure the device is battery powered, double insulated or grounded in a manner that will prevent the hazard of electric shock.

## Water Line Installation Instructions

### WARNING

- When using any electrical device (such as a power drill) during installation, be sure the device is battery powered, double insulated or grounded in a manner that will prevent the hazard of electric shock.

Install the shutoff valve on the nearest frequently used drinking water line.

- 1 SHUT OFF THE MAIN WATER SUPPLY**  
Turn on the nearest faucet to relieve the pressure on the line.
- 2 CHOOSE THE VALVE LOCATION**  
Choose a location for the valve that is easily accessible. It is best to connect into the side of a vertical water pipe. When it is necessary to connect into a horizontal water pipe, make the connection to the top or side, rather than at the bottom, to avoid drawing off any sediment from the water pipe.

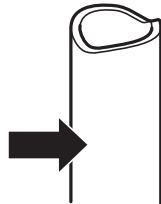

- 3 DRILL THE HOLE FOR THE VALVE**  
Drill a 1/4 in. hole in the water pipe using a sharp bit. Remove any burrs resulting from drilling the hole in the pipe. Be careful not to allow water to drain into the drill. Failure to drill a 1/4 in. hole may result in reduced ice production or smaller cubes.

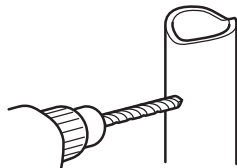

### NOTE

The hookup line cannot be white, plastic tubing. Licensed plumbers must use only copper tubing (NDA tubing #49595 or #49599) or Cross Link Polyethylene (PEX) tubing.

- 4 FASTEN THE SHUTOFF VALVE**  
Fasten the shutoff valve to the cold water pipe with the pipe clamp.

- 5 TIGHTEN THE PIPE CLAMP**

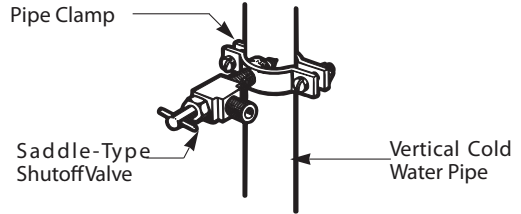

### NOTE

Commonwealth of Massachusetts Plumbing Codes 248CMR shall be adhered to. Saddle valves are illegal and use is not permitted in Massachusetts. Consult with your licensed plumber.

Tighten the clamp screws until the sealing washer begins to swell.

NOTE: Do not overtighten clamp or you may crush the tubing.

- 6 ROUTE THE TUBING**

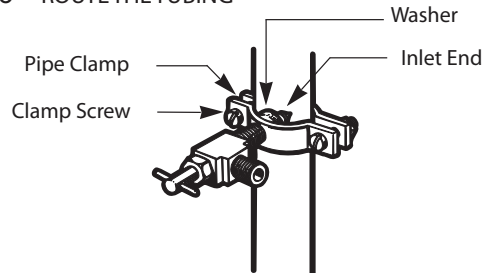

Route the tubing between the cold water line and the refrigerator.

Route the tubing through a hole drilled in the wall or floor (behind the refrigerator or adjacent base cabinet) as close to the wall as possible.

### NOTE

Be sure there is sufficient extra tubing (about 8 feet (2,4 m) coiled into 3 turns of about 10 in. (0,25 m) diameter) to allow the refrigerator to move out from the wall after installation.



- 7 CONNECT THE TUBING TO THE VALVE  
Place the compression nut and ferrule (sleeve) for copper tubing onto the end of the tubing and connect it to the shutoff valve. Make sure the tubing is fully inserted into the valve. Tighten the compression nut securely.

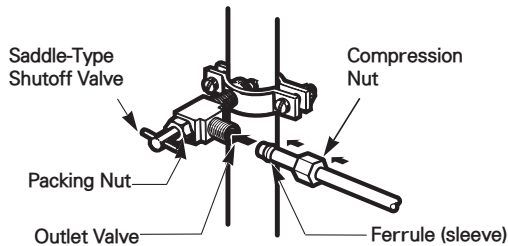

- 8 FLUSH OUT THE TUBING  
Turn the main water supply on and flush out the tubing until the water is clear.

Shut the water off at the water valve after about one quart of water has been flushed through the tubing.



- 9 CONNECT THE TUBING TO THE REFRIGERATOR
- NOTE:** Before making the connection to the refrigerator, be sure that the refrigerator power cord is not plugged into the wall outlet.

- Remove the plastic flexible cap from the water valve.
- Place the compression nut and ferrule (sleeve) onto the end of the tubing as shown.
- Insert the end of the copper tubing into the connection as far as possible. While holding the tubing, tighten the fitting.

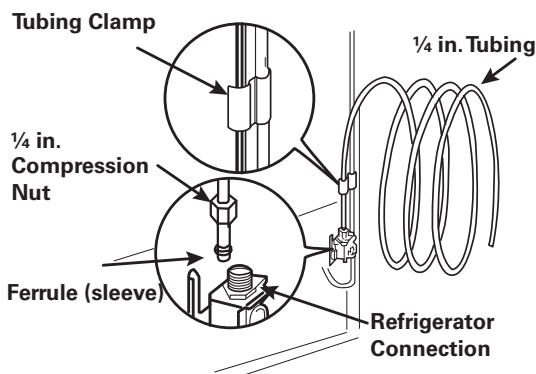

- 10 TURN THE WATER ON AT THE SHUTOFF VALVE  
Tighten any connections that leak.

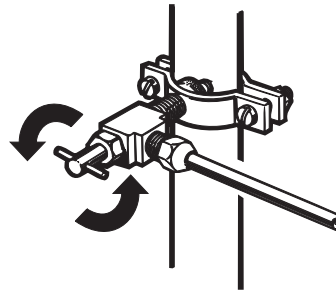

**CAUTION**

Check to see if leaks occur at the water line connections.

- 11 PLUG IN THE REFRIGERATOR  
Arrange the coil of tubing so that it does not vibrate against the back of the refrigerator or against the wall. Push the refrigerator back to the wall.

- 12 START THE ICEMAKER  
The icemaker will not begin to operate until it reaches its operating temperature of 15°F (-9°C) or below.

**Turning On The Power**

- Plug in the refrigerator.

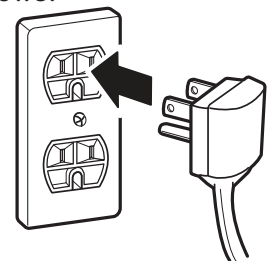

**CAUTION**

- Connect to a rated power outlet.
- Have a certified electrician check the wall outlet and wiring for proper grounding.
- Do not damage or cut off the ground terminal of the power plug.

## Leveling

After installing, plug the refrigerator's power cord into a 3-prong grounded outlet and push the refrigerator into the final position.

Your refrigerator has two front leveling legs—one on the right and one on the left. Adjust the legs to alter the tilt from front-to-back or side-to-side. If your refrigerator seems unsteady, or you want the doors to close more easily, adjust the refrigerator's tilt using the instructions below:

**NOTE:** Tools Required: 11/16" (18mm) wrench or flat blade screwdriver.

- 1 Turn the leveling leg counterclockwise to raise that side of the refrigerator or clockwise to lower it. It may take several turns of the leveling leg to adjust the tilt of the refrigerator.

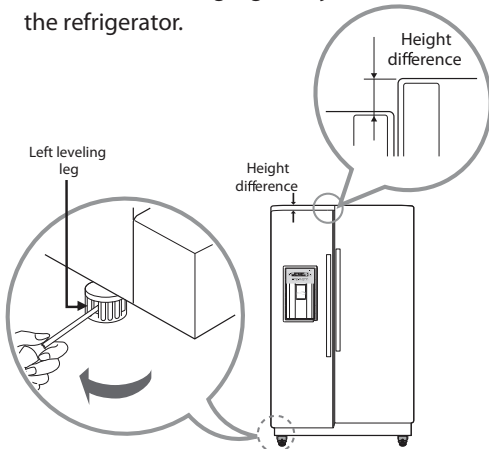

**NOTE:** Having someone push backward against the top of the refrigerator takes some weight off of the leveling legs. This makes it easier to adjust the legs.

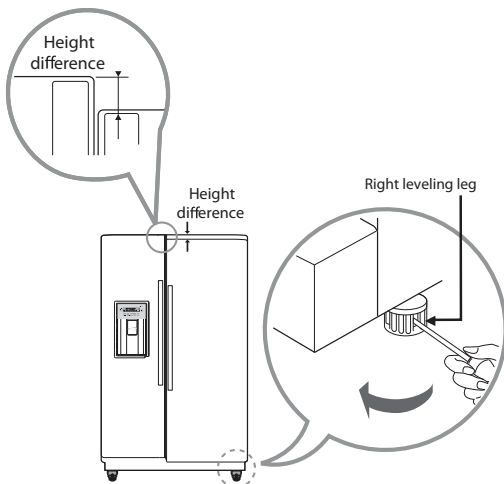

- 2 Open both doors again and check to make sure that they close easily. If the doors do not close easily, tilt the refrigerator slightly more to the rear by turning both leveling legs counterclockwise. It may take several more turns, and you should turn both leveling legs the same amount.

## Door Alignment

If the doors are still uneven after the refrigerator has been leveled, finish adjusting the doors by following the instructions below:

Adjusting tools: 5/16" (8mm) wrench and 3/4" (19mm) wrench.

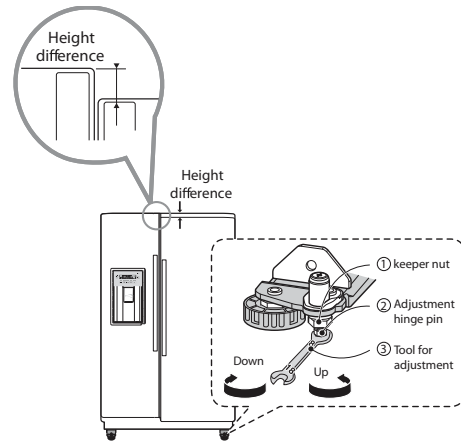

- Using a 3/4" (19mm) wrench, turn the keeper nut counterclockwise to loosen the keeper nut.
- Using a 5/16" (8mm) wrench, turn the adjustment hinge pin clockwise or counterclockwise to level the refrigerator door.
- After leveling the door, turn the keeper nut clockwise to tighten it.

**CAUTION:** Do not overtighten the door adjustment screw. The hinge pin can be pulled out (adjustable range of height is a maximum of 2 in. (5 cm)).

# HOW TO USE

## Before Use

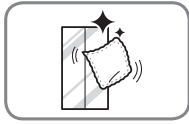

### Clean the refrigerator.

Clean your refrigerator thoroughly and wipe off all dust that accumulated during shipping.

#### ! CAUTION

- Do not scratch the refrigerator with a sharp object or use a detergent that contains alcohol, a flammable liquid or an abrasive when removing any tape or adhesive from the refrigerator.
- Do not peel off the model or serial number label or the technical information on the rear surface of the refrigerator.

#### ! NOTE

Remove adhesive residue by wiping it off with your thumb or dish detergent.

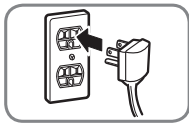

### Connect the power supply.

Check if the power supply is connected before use.  
Read the "Turning On The Power" section.

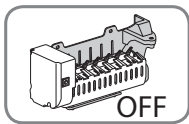

### Turn off the icemaker if the refrigerator is not yet connected to the water supply.

Plug the power plug of the refrigerator into the grounded electric outlet and then turn off the automatic icemaker.

\*This is applicable only to certain models.

#### ! CAUTION

Running the automatic icemaker before connecting it to the water supply may cause the refrigerator to malfunction.

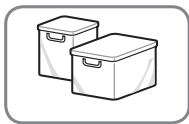

### Wait for the refrigerator to cool.

Allow your refrigerator to run for at least two to three hours before putting food in it. Check the flow of cold air in the freezer compartment to ensure proper cooling.

#### ! CAUTION

Putting food in the refrigerator before it has cooled could cause the food to spoil, or a bad odor could linger inside the refrigerator.



### The refrigerator makes a loud noise after initial operation.

This is normal. The volume will decrease as the temperature lowers.

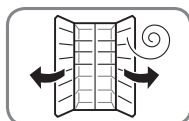

### Open refrigerator and freezer doors to ventilate the interior.

The inside of the refrigerator may smell like plastic at first. Remove any adhesive tape from inside the refrigerator and open the refrigerator and freezer doors for ventilation.

## Control Panel

The refrigerator control functions as the thermostat for the entire appliance (refrigerator and freezer sections). The colder the setting, the longer the compressor will run to keep the temperature colder. The freezer control adjusts the cold air flow from the freezer to the refrigerator. Setting the freezer control to a lower temperature keeps more cold air in the freezer compartment to make it colder.

## Airflow

Cold air circulates from the freezer to the fresh food section and back again through air vents in the wall dividing the two sections. Be sure not to block vents while packing your refrigerator. Doing so will restrict airflow and may cause the refrigerator temperature to become too warm or cause interior moisture buildup. (See air flow diagram below.)

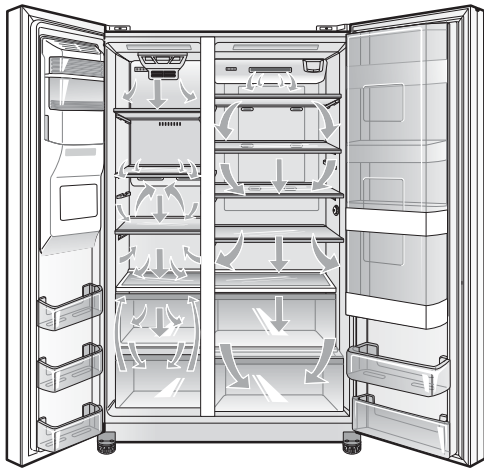

## IMPORTANT:

Because air circulates between both sections, any odors formed in one section will transfer to the other. You must thoroughly clean both sections to eliminate odors.

To prevent odor transfer and dried out food, wrap or cover foods tightly. (See the Food Storage Guide section for details.)

**NOTE:** If you close the refrigerator door, you may see the freezer door open and close again due to pressure from internal air flow.

## Control Panel Features

\* Depending on the model, some of the following functions may not be available.

### Vertical Display

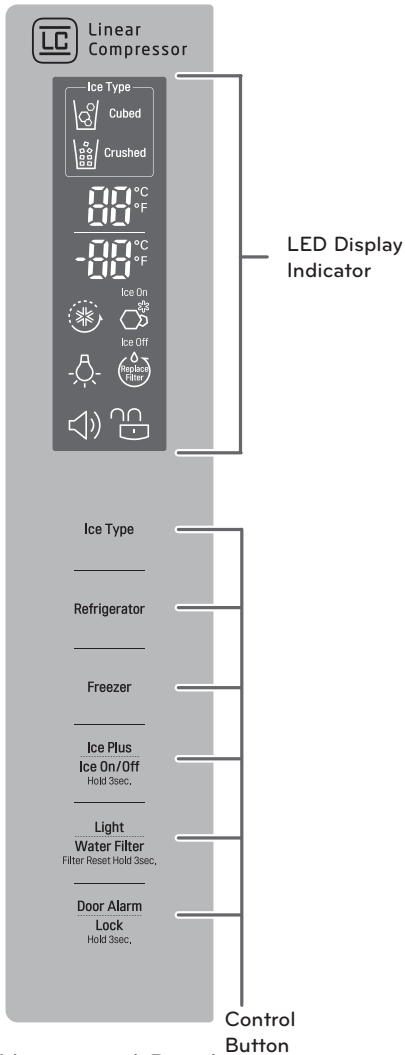

### Horizontal Display

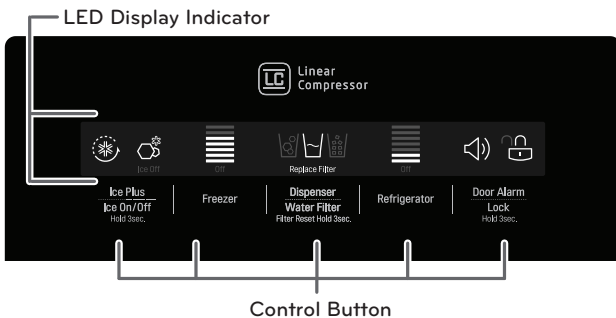

## Ice Type

### Vertical Display

Select Crushed Ice or Cubed Ice by pressing the Ice Type button repeatedly to choose the selection desired. The Crushed Ice or Cubed Ice icon will light up to indicate your selection.



Selecting this icon indicates that cubed ice will be dispensed when the dispenser pad is activated.



Selecting this icon indicates that crushed ice will be dispensed when the dispenser pad is activated.

### Horizontal Display

Select Crushed Ice, Cubed Ice or Water by pressing the Dispenser button repeatedly to choose the selection desired. The Icon will light up to indicate your selection.



To dispense water or ice, gently push your cup against the dispenser pad (see page 26).

**NOTE:** Hold your cup in place for a couple of seconds after dispensing ice or water so the last few drops go in your cup instead of on the floor.

## Temperature

- The Refrigerator Temp. Control ranges from 33°F to 46°F (1°C to 8°C). Press the Refrigerator button to cycle through the available temperature settings one increment at a time.
- The Freezer Temp. Control range is from -6°F to 8°F (-21°C to -13°C). Press the Freezer button to cycle through the available temperature settings one increment at a time.

**NOTE:** When changing control settings, wait 24 hours before making additional adjustments. The controls are set correctly when milk or juice is as cold as you would like and when ice cream is firm. If the temperature in either compartment is too cold or too warm, change the setting one increment at a time. Wait 24 hours for the change to stabilize before adjusting again.

## Temperature Mode Switch Function (°F <->°C)

If you want to convert °F to °C or vice versa, press and hold the Freezer and Refrigerator buttons at the same time for approximately five seconds. (Type 2 is not available)

## Ice Plus

- When you press the Ice Plus button, the graphic will illuminate in the display and will continue for 24 hours. The function will automatically shut off after 24 hours.
- You can stop this function manually by pressing the button one more time.
- This function increases both ice making and freezing capabilities.

## Ice ON/OFF

- To turn off the automatic icemaker, press and hold the Ice ON/OFF button for three seconds until the Ice Off text is illuminated. To turn on the automatic ice maker, press and hold until the Ice On text is illuminated.

## Light

This light has two settings: ON and OFF. Press the Light button to turn the dispenser light on and off. (Not available on all models)

## Water Filter Reset

When the water filter indicator turns on, you need to replace the water filter. After replacing the water filter, press and hold the Replace Filter button for three seconds to turn the indicator light off. You need to replace the water filter approximately every six months.

## Door Alarm

- When power is connected to the refrigerator, the door alarm is initially set to ON. When you press the Door Alarm button, the display will change to OFF and the Door Alarm function will deactivate.
- When either the refrigerator or the freezer door is left open for more than 60 seconds, the alarm tone will sound to let you know that the door is open.
- When you close the door, the door alarm will stop.

## Lock

- When power is initially connected to the refrigerator, the Lock function is off.
- If you want to activate the Lock function to lock other buttons, press and hold the Door Alarm button for three seconds or more. The Lock icon will display and the Lock function is now enabled.
- When the Lock function is activated, no other buttons will work. The dispenser pad is also deactivated.
- To disable the Lock function, press and hold the Door Alarm button for approximately three seconds.

## Display Off Mode

When the refrigerator is in the Display Off Mode, the display will remain off until a door is opened or a button is pressed. Once on, the display will remain on for 20 seconds.

## Demo Mode (For Store Use Only)

The Demo Mode disables all cooling in the refrigerator and freezer sections to conserve energy while on display in a retail store. When activated, OFF will display on the control panel.

To deactivate:

With either refrigerator door opened, press and hold the Refrigerator Temp. and Ice Plus buttons at the same time for five seconds. The control panel will beep and the temperature settings will display to confirm that Demo Mode is deactivated. Use the same procedure to activate the Demo Mode .

## Automatic Icemaker

Ice is made in the automatic icemaker and sent to the dispenser. The icemaker will produce 7 cubes per cycle - approximately 70-120 cubes in a 24-hour period, depending on freezer compartment temperature, room temperature, number of door openings and other operating conditions.

- It takes about 12 to 24 hours for a newly installed refrigerator to begin making ice. Wait 72 hours for full ice production to occur.
- Ice making stops when the ice storage bin is full. When full, the ice bin holds approximately 6 to 8 (12-16 oz) glasses of ice.
- To turn off the automatic icemaker, set the Ice ON/OFF button on the display to Ice Off .To turn on the automatic icemaker, set the ON/OFF button on the display to Ice On .
- The water pressure must be between 20 and 120 psi ( 138 – 827 kPa ) on models without a water filter and between 40 and 120 psi on ( 276 – 827 kPa ) models with a water filter to produce the normal amount and size of ice cubes.

### When You Should Turn the Icemaker Off

Set the Ice ON/OFF Button to "Ice Off":

- When the water supply will be shut off for several hours.
- When the ice bin is removed for more than one or two minutes.
- When the refrigerator will not be used for several days.

NOTE: The ice bin should be emptied when the Ice ON/OFF button is set to the Ice Off mode.

### Normal Sounds You May Hear

NOTE: Keeping the Ice ON/OFF button set to the Ice On mode before the water line is connected can damage the icemaker.

- You will hear the sound of cubes dropping into the bin and water running in the pipes as the icemaker refills.



### WARNING

Personal Injury Hazard

DO NOT place fingers or hands on the automatic ice making mechanism while the refrigerator is plugged in.

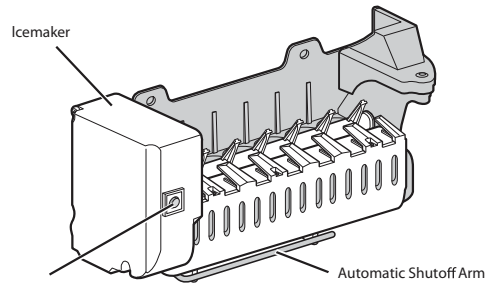

### Preparing for Vacation

Set the Ice ON/OFF button to the Ice Off mode and shut off the water supply to the refrigerator.

NOTE: The ice bin should be emptied any time the Ice ON/OFF button is set to the Ice Off mode.

If the ambient temperature will drop below freezing, have a qualified technician drain the water supply system to prevent serious property damage due to flooding caused by ruptured water lines or connections.

### Power Failure

During a power failure, ice may drop into the freezer compartment. Remove the ice storage bin and discard all the ice. Dry the storage bin and reinstall it. Once power is restored, crushed ice will be selected by default.

NOTE: Do not dispense ice continuously for more than 30 sec. Depress and release the dispenser pad for cycles of 30 seconds ON and 60 seconds OFF.

## Automatic Icemaker (continued)



### CAUTION

- The first ice and water dispensed may include particles or odor from the water supply line or the water tank.
- Throw away the first few batches of ice (about 24 cubes). This is also necessary if the refrigerator has not been used for a long time.
- Never store beverage cans or other items in the ice bin for the purpose of rapid cooling. Doing so may damage the icemaker or the containers may burst.
- If discolored ice is dispensed, check the water filter and water supply. If the problem continues, contact a qualified service center. Do not use the ice or water until the problem is corrected.
- Keep children away from the dispenser. Children may play with or damage the controls.
- The ice passage may become blocked with frost if only crushed ice is used. Remove the frost that accumulates by removing the ice bin and clearing the passage with a rubber spatula. Dispensing cubed ice can also help prevent frost buildup.
- Never use thin crystal glass or crockery to collect ice. Such containers may chip or break resulting in glass fragments in the ice.
- Dispense ice into a glass before filling it with water or other beverages. Splashing may occur if ice is dispensed into a glass that already contains liquid.
- Never use a glass that is exceptionally narrow or deep. Ice may jam in the ice passage and refrigerator performance may be affected.
- Keep the glass at a proper distance from the ice outlet. A glass held too close to the outlet may prevent ice from dispensing.
- To avoid personal injury, keep hands out of the ice door and passage.
- Never remove the dispenser cover.



## Ice and Water Dispenser

\* Depending on the model, some of the following functions may not be available.

### CAUTION

Keep children away from the dispenser. Children may play with or damage the controls.

### Dispenser structure

Water Switch

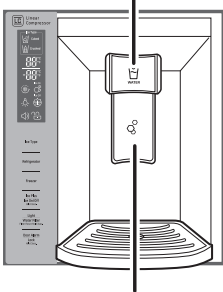

Ice Switch

Ice & Water Switch

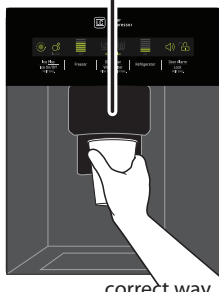

correct way

### Using the dispenser

- To dispense cold water, push on the water switch with a glass.
- To dispense ice, push on the ice switch with a glass.

### NOTE

- If discolored ice is dispensed, check the water filter and water supply. If the problem continues, contact a qualified service center. Do not use the ice or water until the problem is corrected.
- The dispenser will not operate when either of the refrigerator doors are open.
- If dispensing water or ice into a container with a small opening, place it as close to the dispenser as possible.
- Some dripping may occur after dispensing. Hold your cup beneath the dispenser for a few seconds after dispensing to catch all of the drops.

	Incorrect Way	Correct Way
Water		
Ice		

### CAUTION

Throw away the first few batches of ice (about 24 cubes). This is also necessary if the refrigerator has not been used for a long time.

### Locking the dispenser

Press and hold the Alarm and Lock button simultaneously for 3 seconds to lock the dispenser and all the control panel functions. Follow the same instructions to unlock.

### Cleaning the dispenser stand

The dispenser drip tray has no self-draining function. It should be cleaned regularly.

(Models with a combined ice and water switch do not have a drip tray).

- 1 To remove, grip the tray with both hands and pull it out. Wipe out dirty areas and dry with a clean cloth.

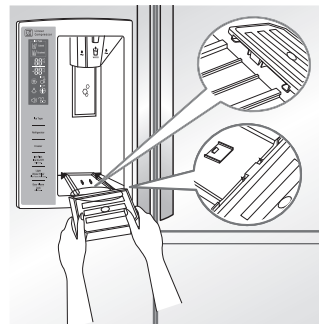

- 2 To reinstall the tray, slightly tilt the front of the tray and snap the ribs into the holes.

## Storing Food

### Food Preservation Location

Each compartment inside the refrigerator is designed to store different types of food.

Store your food in the optimal space to enjoy the freshest taste.

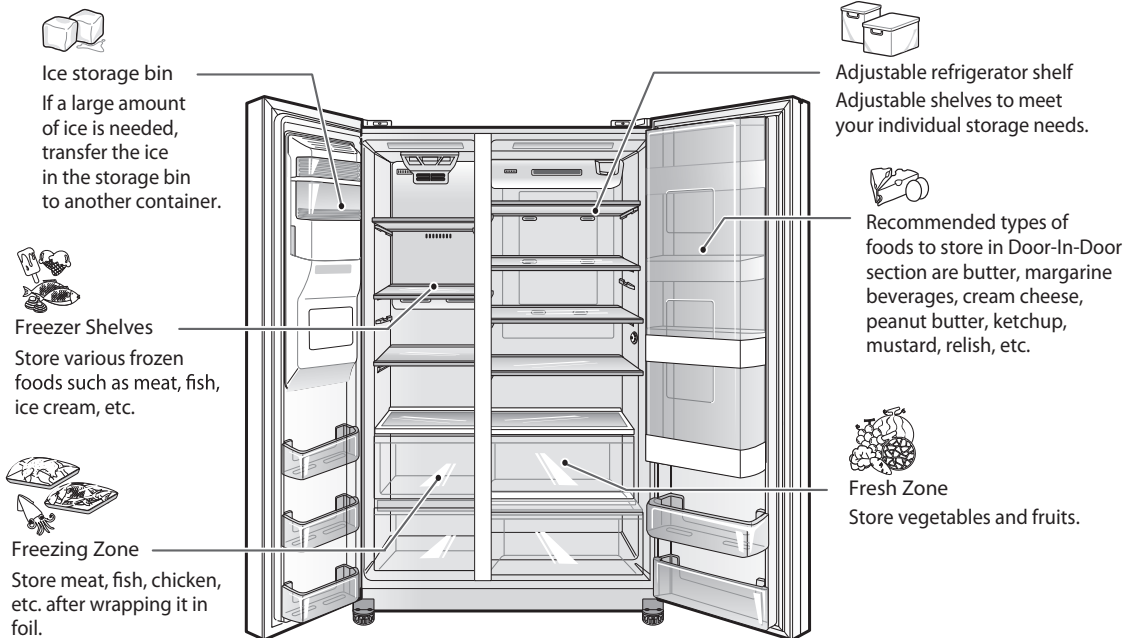

### DOOR-IN-DOOR MODEL

#### ⚠ CAUTION

- Do not store food with high moisture content towards the top of the refrigerator. The moisture could come in direct contact with the cold air and freeze.
- Wash food before storing it in the refrigerator. Vegetables and fruit should be washed, and food packaging should be wiped down to prevent adjacent foods from being contaminated.
- If the refrigerator is kept in a hot and humid place, frequent opening of the door or storing a lot of vegetables in the refrigerator may cause condensation to form. Wipe off the condensation with a clean cloth or a paper towel.
- If the refrigerator or freezer door is opened or closed too often, warm air may penetrate the refrigerator and raise its temperature. This can increase the running costs of the unit.
- Do not overfill or pack items too tightly into door bins. Doing so may cause damage to the bin or personal injury if items are removed with excessive force.
- Do not store glass containers in the freezer. Contents may expand when frozen, break the container and cause injury.

#### ⚠ NOTE

- If you are leaving home for a short period of time, like a short vacation, the refrigerator should be left on. Refrigerated foods that are able to be frozen will stay preserved longer if stored in the freezer.
- If you are leaving the refrigerator turned off for an extended period of time, remove all food and unplug the power cord. Clean the interior, and leave the doors open to prevent fungi from growing in the refrigerator.

## Storing Food

### Food Preservation Location

Each compartment inside the refrigerator is designed to store different types of food.

Store your food in the optimal space to enjoy the freshest taste.

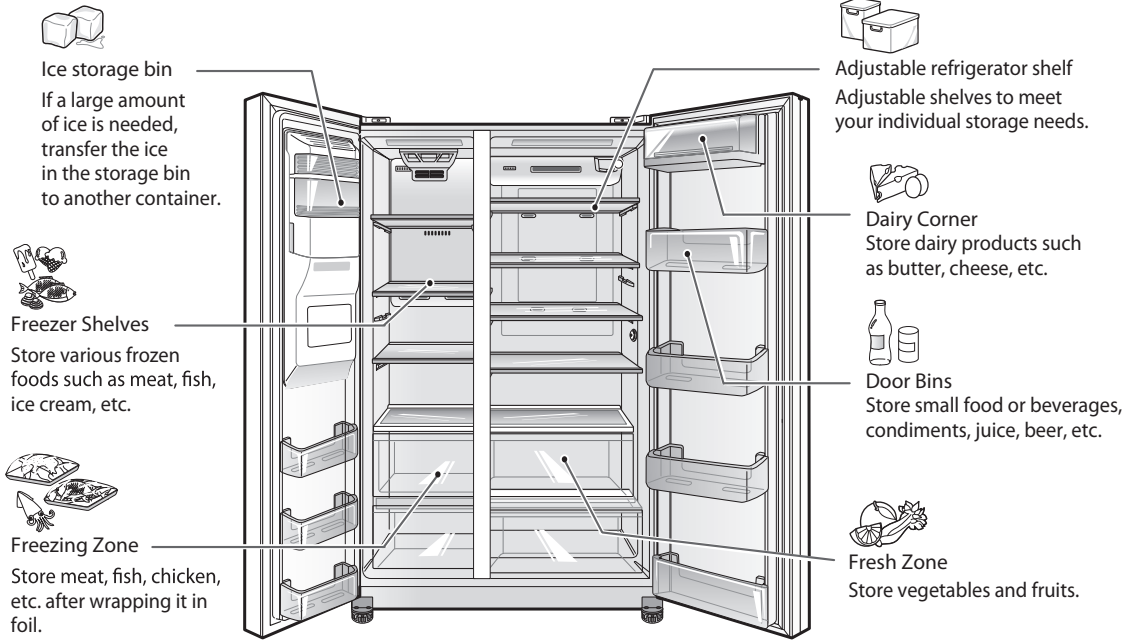

ALL STANDARD DOOR MODELS



### CAUTION

- Do not store food with high moisture content towards the top of the refrigerator. The moisture could come in direct contact with the cold air and freeze.
- Wash food before storing it in the refrigerator. Vegetables and fruit should be washed, and food packaging should be wiped down to prevent adjacent foods from being contaminated.
- If the refrigerator is kept in a hot and humid place, frequent opening of the door or storing a lot of vegetables in the refrigerator may cause condensation to form. Wipe off the condensation with a clean cloth or a paper towel.
- If the refrigerator or freezer door is opened or closed too often, warm air may penetrate the refrigerator and raise its temperature. This can increase the running costs of the unit.
- Do not overfill or pack items too tightly into door bins. Doing so may cause damage to the bin or personal injury if items are removed with excessive force.
- Do not store glass containers in the freezer. Contents may expand when frozen, break the container and cause injury.



### NOTE

- If you are leaving home for a short period of time, like a short vacation, the refrigerator should be left on. Refrigerated foods that are able to be frozen will stay preserved longer if stored in the freezer.
- If you are leaving the refrigerator turned off for an extended period of time, remove all food and unplug the power cord. Clean the interior, and leave the doors open to prevent fungi from growing in the refrigerator.
- Parts, features and options vary by model. Your model may not include every option.

## Food Storage Tips

\* The following tips may not be applicable depending on the model.

Wrap or store food in the refrigerator in airtight and moisture-proof material unless otherwise noted. This prevents food odor and taste transfer throughout the refrigerator. For dated products, check date code to ensure freshness.

Food	How To
<b>Butter or Margarine</b>	Keep opened butter in a covered dish or closed compartment. When storing an extra supply, wrap in freezer packaging and freeze.
<b>Cheese</b>	Store in the original wrapping until you are ready to use it. Once opened, rewrap tightly in plastic wrap or aluminum foil.
<b>Milk</b>	Wipe milk cartons. For coldest milk, place containers on an interior shelf.
<b>Eggs</b>	Store in original carton on interior shelf, not on door shelf.
<b>Fruit</b>	Do not wash or hull the fruit until it is ready to be used. Sort and keep fruit in its original container, in a crisper, or store in a completely closed paper bag on a refrigerator shelf.
<b>Leafy Vegetables</b>	Remove store wrapping and trim or tear off bruised and discolored areas. Wash in cold water and drain. Place in plastic bag or plastic container and store in vegetable drawer.
<b>Vegetables with skins (carrots, peppers)</b>	Place in plastic bags or plastic container and store in vegetable drawer.
<b>Fish</b>	Store fresh fish and shellfish in the freezer section if they are not being consumed the same day of purchase. It is recommended to consume fresh fish and shellfish the same day purchased.
<b>Leftovers</b>	Cover leftovers with plastic wrap or aluminum foil, or store in plastic containers with tight lids.
<b>Ice Cream</b>	When storing frozen food like ice cream for a long period, place it on the freezer shelf, not in the door bins.

## Storing Frozen Food



### NOTE

Check a freezer guide or a reliable cookbook for further information about preparing food for freezing or food storage times.

### Freezing

Your freezer will not quick-freeze a large quantity of food. Do not put more unfrozen food into the freezer than will freeze within 24 hours (no more than 2 to 3 lbs. of food per cubic foot of freezer space). Leave enough space in the freezer for air to circulate around packages. Be careful to leave enough room at the front so the door can close tightly.

Storage times will vary according to the quality and type of food, the type of packaging or wrap used (how airtight and moisture-proof) and the storage temperature. Ice crystals inside a sealed package are normal. This simply means that moisture in the food and air inside the package have condensed, creating ice crystals.



### NOTE

Allow hot foods to cool at room temperature for 30 minutes, then package and freeze. Cooling hot foods before freezing saves energy.

## Storing Frozen Food (continued)

### Packaging

Successful freezing depends on correct packaging. When you close and seal the package, it must not allow air or moisture in or out. If it does, you could have food odor and taste transfer throughout the refrigerator and could also dry out frozen food.

### Packaging recommendations:

- Rigid plastic containers with tight-fitting lids
- Straight-sided canning/freezing jars
- Heavy-duty aluminum foil
- Plastic-coated paper
- Non-permeable plastic wraps
- Specified freezer-grade self-sealing plastic bags

Follow package or container instructions for proper freezing methods.

### Do not use

- Bread wrappers
- Non-polyethylene plastic containers
- Containers without tight lids
- Wax paper or wax-coated freezer wrap
- Thin, semi-permeable wrap

## Detaching and Assembling the Storage Bins

### Fresh Zone Drawers

The Fresh Zone drawers provide storage for fruit and vegetables.

To remove the Fresh Zone drawers, pull out the drawer to full extension ①, lift the front up ②, and pull straight out.

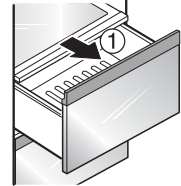

To install, slightly tilt up the front, insert the drawer into the frame and push it back into place.

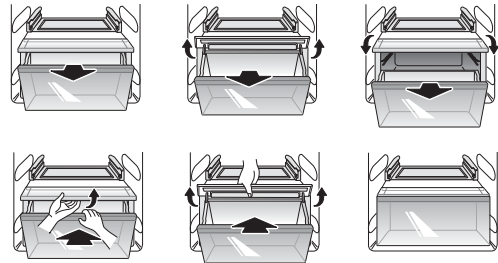
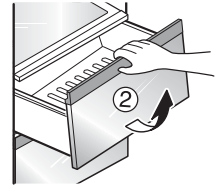

**NOTE:** When removing or installing the lower Fresh Zone drawer, lift the cover to help remove or insert the drawer.



### CAUTION

- Use both hands to assemble and disassemble the Fresh Zone. The compartment is heavy when filled with food and may cause injury if dropped.
- Open the refrigerator door fully when disassembling or reassembling the Fresh Zone.

### To Remove the Fresh Zone Cover

Hold the cover with both hands and pull it out.

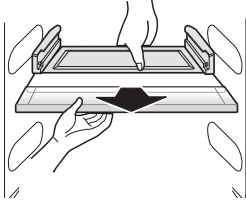

**NOTE:** Remove the Fresh Zone drawers before removing the Fresh Zone cover.

### Door Bins

The door bins are removable for easy cleaning and adjustment.

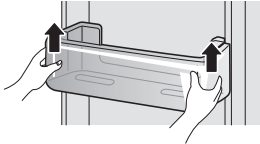

- 1 To remove the bin, simply lift the bin up and pull straight out.

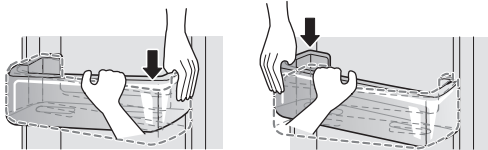

- 2 To replace the bin, slide it in above the desired support and push down one side at a time until it snaps into place.

**NOTE**

Some bins may vary in appearance and will only fit in one location.

**CAUTION**

- Do not apply excessive force while detaching or assembling the storage bins.
- Do not use the dishwasher to clean the storage bins and shelves.
- Regularly detach and wash the storage bins and shelves; they can become easily contaminated by the food.

### Water Tank

**CAUTION:** You will see the water tank while removing the Fresh Zone drawer. Do not remove the water tank or water leakage may occur. The water tank is not a removable part.

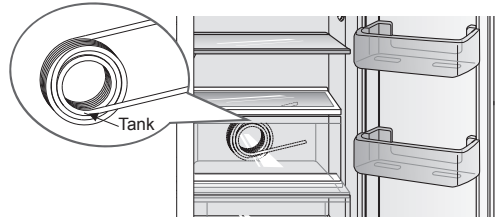

### Dairy Corner ( Basic Model )

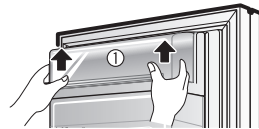

- 1 To remove the Dairy Corner, simply lift the bin up and pull straight out.
- 2 To replace the Dairy Corner, slide it in above the desired support and push down until it snaps into place.

**NOTE:** If you close the refrigerator door with the Dairy Corner open, the refrigerator door may not close properly. Make sure to close the Dairy Corner completely after use.

## Door-in-Door (Door-in-Door Model)

The Door-in-Door compartment allows for easy access to commonly used food items. The outer Door-in-Door door includes three additional door bins.



### Door-in-Door Compartment

To access the Door-in-Door compartment, lightly press the button on the right refrigerator door handle until you hear a click to open the door.

## Door-in-Door Door Bins

The Door-in-Door inner and outer door bins are removable for easy cleaning.

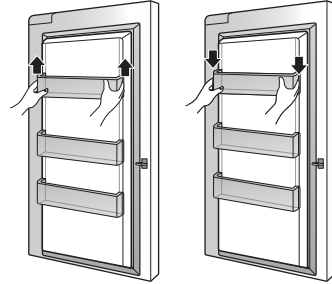

- 1 To remove the door bins, lift up and pull out.
- 2 To replace the door bins, slide the door bin in above the desired support and push down until it snaps into place.

## Door-in-Door Case

To open the Door-In-Door case, pull evenly on the marked area. The Door-In-Door Case is removable for easy cleaning and adjustment.

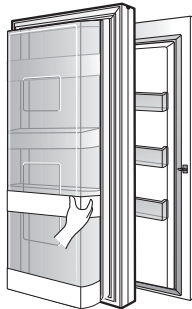

**CAUTION:** Remove contents from Door-in-Door case before disassembly.

- 1 To remove the Door-In-Door case, lift up and pull out.
- 2 To replace the Door-In-Door case, line the tabs on the Door-In-Door Case with the slots on the door and push down until it snaps into place.

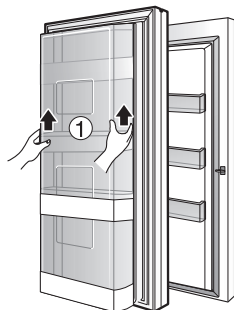

## Adjusting the Refrigerator Shelves

The shelves in your refrigerator are adjustable to meet your individual storage needs.

Adjusting the shelves to fit items of different heights will make finding the exact item you want easier. Doing so will also reduce the amount of time the refrigerator door is open which will save energy.

### Detaching the Shelf

- ① Remove all items from the shelf. Lift the back of the shelf slightly to disengage the rail stops.
- ② Holding the shelf with both hands, tilt the shelf and pull it out.

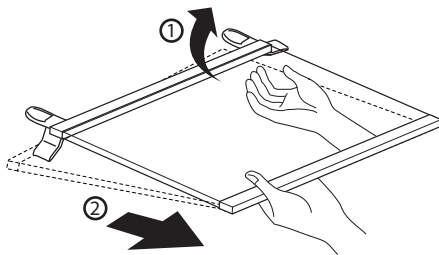

### Assembling the Shelf

Tilt the front of the shelf up and guide the shelf into the slots at a desired height, keeping shelf holder down. ① Slide the shelf in, then lower the front of the shelf. ②

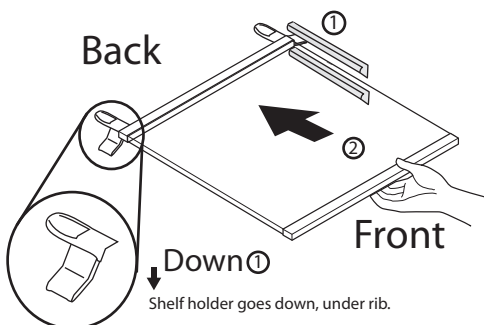

### CAUTION

Make sure that shelves are level from one side to the other. Failure to do so may result in the shelf falling or food spilling.

## Suggested Placement of Shelves

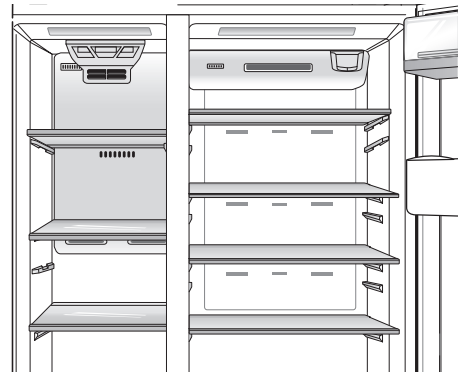

### NOTE

- Parts, features and options vary by model. Your model may not include every option.
- Standard door models with a horizontal display have three refrigerator shelves.
- All models have two different sizes of freezer shelf. The larger shelf fits in the lower section of the freezer

### CAUTION

- Do not clean glass shelves with warm water while they are cold. Shelves may break if exposed to sudden temperature changes or impact.
- Glass shelves are heavy. Use special care when removing them.