

# LG CordZero™

## Owner's Manual

### A9

- Charge the battery fully before first use.
- Read the Safety Instructions before using the product.
- After reading this manual, keep it in an easily accessible location.

A90\*\*\*\*



MFL69883611

[www.lg.com](http://www.lg.com)

Copyright © 2018 - 2019 LG Electronics Inc. All Rights Reserved.



# Table of Contents

<b>Safety Instructions</b> .....	<b>04</b>
<b>Product Overview</b> .....	<b>09</b>
<b>Installation</b> .....	<b>10</b>
Freestanding Installation .....	10
Wall Installation .....	11
Uninstalling the Station.....	11
Attachment Storage.....	12
Nozzle Storage.....	12
<b>Operation</b> .....	<b>13</b>
Before Using.....	13
Attaching the Wand and Accessories .....	13
Charging the Battery.....	14
Adjusting the Suction.....	14
Using the Nozzles.....	15
<b>Maintenance</b> .....	<b>16</b>
Emptying the Dust Bin .....	16
Cleaning the Filters.....	16
Cleaning the Power Floor/Carpet Nozzle .....	18
Cleaning the Power Punch Nozzle .....	18
<b>Before Calling for Service</b> .....	<b>19</b>
<b>Product Specifications</b> .....	<b>20</b>
<b>Warranty</b> .....	<b>21</b>

## Safety Instructions

Your safety and the safety of others are very important. We have provided many important safety messages in this manual and on the appliance. Always read and follow all safety messages.

### Basic Safety Precautions

After reading this manual, please keep it in an easily accessible location.



This is the safety alert symbol. The symbol alerts you to potential hazards that can kill or injure you and others. All safety messages will follow the safety alert symbol and either the word **WARNING** or **CAUTION**. These words mean:



**WARNING**

Failure to follow the instructions could result in death or serious injury.



**CAUTION**

Failure to follow the instructions could result in personal injury or property damage.

## IMPORTANT SAFETY INSTRUCTIONS

### **WARNING**

1. This appliance is not intended for use by persons (including children) with reduced physical, sensory or mental capabilities, or lack of experience and knowledge, unless they have been given supervision or instruction concerning use of the appliance by a person responsible for their safety.
2. Children should be supervised to ensure that they do not play with the appliance.
3. If the supply cord is damaged, it must be replaced by an LG Electronics Service Agent in order to avoid a potential hazard.
4. This appliance can be used by children aged 8 years and above and persons with reduced physical, sensory or mental capabilities or lack of experience and knowledge if they have been given supervision or instruction concerning use of the appliance in a safe way and understand the hazards involved. Children shall not play with the appliance.  
Cleaning and user maintenance must not be performed by children without supervision.

## SAVE THESE INSTRUCTIONS

To reduce the risk of fire, explosion, electric shock, or injury to persons when using this appliance, follow basic precautions, including the following:

## Installation and Usage

- **To avoid an electrical short or fire, do not install, charge or store the product where it may be exposed to water, rainfall or high humidity. Do not use the product in any outdoor location, workshop or garage environment.**
- Install, charge or store the product in a well-ventilated place.
- Do not store or use the product in areas with flammable gas leakage, industrial oil, or metallic dust.
- Install the charging station on a firm, level surface.
- **To prevent tipover, freestanding installations should be anchored to the wall using the provided wall-anchoring block and screw.**
- If mounting the charging station on the wall, make sure the screws are securely fastened.
- **Use the anchoring screws only when attaching to concrete or similar solid surfaces.**
- **Never drill into a wall without first checking that the area behind it is free from power conduits, plumbing, vents, or cables.**
- **Do not use or store the product at temperatures below 41°F (5°C) or above 100°F (38°C).**
- Adhere to all industry recommended safety procedures including the use of long-sleeved gloves and safety glasses.
- Never attempt to operate this appliance if it is damaged, malfunctioning, partially disassembled, or has missing or broken parts, including a damaged cord or plug.
- When installing or moving the appliance, be careful not to pinch, crush, or damage the power cord or plug.
- Keep packing materials out of the reach of children. Packaging materials can pose a suffocation risk for children.
- Destroy the carton, plastic bag, and other packing materials after the appliance is unpacked. Children might use them for play. Cartons covered with rugs, bedspreads, or plastic sheets can become airtight chambers.
- Store and install the appliance where it will not be exposed to temperatures below freezing or exposed to outdoor weather conditions.
- Do not damage, alter, excessively bend, twist, pull, pinch or heat the power cord.
- Call an authorized service technician to repair or immediately replace all power cords that have become damaged. Do not use a cord or plug that shows cracks or abrasion damage along its length or at either end.
- Do not use multiple-outlet adapters with this product.
- Do not plug the product into a damaged or loose outlet.
- In the event of a gas leak (natural gas, propane gas, etc.) do not operate this or any other appliance. Open a window or door to ventilate the area immediately.
- Do not disassemble, repair or modify the product.
- Do not store or use flammable gases or materials near the appliance.
- This appliance is not intended for use by persons (including children) with reduced physical, sensory or mental capabilities, or lack of experience and knowledge, unless they have been given supervision or instruction concerning the use of the appliance by a person responsible for their safety.
- Do not allow children to play with or hang on the charging station.
- Wash hands after handling nozzles. The nozzles contain carbon fiber, and contact may cause minor skin irritation.

## Operation

- Read all instructions before using the appliance, and save these instructions.
- This appliance is designed for normal indoor domestic use only. It is not to be used for any non-residential, commercial, or industrial application.
- Do not tamper with controls.
- If the product has been submerged, contact an LG Electronics customer information center for instructions before resuming use.
- Push the power plug firmly into the wall outlet so that it is not loose.
- Do not modify or extend the power cord.
- If the product makes a strange noise or emits an odor or smoke, discontinue use and contact an LG Electronics customer information center.
- Do not cover the power cord with a rug or carpeting. Placing heavy objects on top of the cord or plug could damage it.
- Keep the product away from open flames.
- **Do not insert fingers or objects into the suction inlet or outlet.**
- Keep hands away from moving brush.
- Do not operate the appliance with the suction inlet or outlet blocked.
- Do not vacuum up toxic solutions such as chlorine bleach, ammonia, or drain cleaner.
- Do not spray combustible materials such as gasoline or solvents, surfactants such as detergents or bath soaps, or drinks near the cleaner or its charging station.
- Do not let liquids such as water enter the product, and do not use the product to pick up liquids, sharp pointy objects, or hot embers.
- Do not store or install the product or the power cord or plug near heating devices.
- Do not allow children or pets to play with the product or use the product as a toy.
- Unplug the power cord before cleaning or maintaining the charging station.
- Do not use in an enclosed space where vapors are present from paint, paint thinner, moth-proofing substances, flammable dust or other explosive or toxic materials.
- Unplug the power cord if the product is not to be used for an extended period.
- Do not disassemble the battery.
- Do not subject the battery to physical impacts.
- Use only the specified battery charger and battery included with the product. Do not use the provided adapter with any other products or for other than its intended use. Read and follow instructions in this manual to charge the battery properly. Failure to follow these warnings may result in damage to the battery or fire.
- If liquid leaks from the battery, avoid bringing the liquid into contact with the skin or eyes.
- If you come into contact with battery fluid, wash the affected area well with water and seek medical attention. There is a risk of burns and blindness.
- If you inhale battery fluid, you may experience respiratory irritation. Move to an area with fresh air and seek medical attention.
- Do not use outdoors or on wet surfaces.
- Do not use inside a moving car.
- Use the product only as described in this manual. Use only the manufacturer's recommended attachments.
- Keep loose clothing and hair, fingers, or other parts of the body away from openings and moving parts.
- Do not use without the filter in place.
- Dispose of the product properly. The battery cells can cause a fire or explode if not disposed of properly.
- Remove battery before disposing of the product.
- Follow all local ordinances and regulations when handling or disposing of the battery.
- Do not point the nozzle or tools at eyes or ears. Do not insert the nozzle or tools in the mouth.
- Do not lean the product on wall, chairs or tables.

### **WARNING**

- This product is rated for use with a 120 VAC, 60 Hz, 15 amp outlet.
- Do not handle the power cord, plug, or appliance controls with wet hands.
- Wipe any moisture or dirt off the cord or plug with a dry cloth.
- Unplug the power cord using the plug, not the cord. Pulling on the cord can damage it and result in electric shock or fire.

- This product is too heavy for use by children.
- Only qualified LG Electronics technicians or service personnel may disassemble, repair or modify the product.
- Do not insert metal objects into holes or gaps in the product or the charging station.
- Do not put any object into openings. Do not use with any opening blocked; keep free of dust, lint, hair, and anything that may reduce airflow.
- Do not expose the product or the battery to heat, heating devices, or direct sunlight.
- Do not store the product or the battery inside a vehicle which is exposed to direct sunlight.
- Do not wash the inlet port with water or detergent.
- Always use the charging station and adaptor provided with the product to charge the product and its battery.
- Never allow any water, beverage or detergent to get inside the battery.
- Do not touch the charging terminals on the product or the charging station, or insert an electrified object inside the product or the station.
- Always store the product in the charging station when not in use, unless the charging station is not attached to the wall or to the charging station support.
- If the earth leakage breaker is tripped when the product is put on the charging station, immediately remove the product from the charging station and contact an LG Electronics customer information center.
- Do not wash the dust bin with water.
- Do not use detergents, polishes or air fresheners to clean the dust bin.
- Do not clean the dust bin in a dishwasher.
- Do not clean fine dust such as cement with the product.
- Before using the product, remove any wire or string from the bottom of the Charging Station.
- Do not allow to be used as a toy. Close attention is necessary when used by or near children.
- Use only as described in this manual. Use only manufacturer's recommended attachments.
- Do not use with damaged cord or plug. If appliance is not working as it should, has been dropped, damaged, left outdoors, or dropped into water, return it to a service center.
- Do not pull or carry by cord, use cord as a handle, close a door on cord, or pull cord around sharp edges or corners.
- Do not unplug by pulling on cord. To unplug, grasp the plug, not the cord.
- Do not handle charger, including charger plug, and charger terminals with wet hands.
- Use extra care when cleaning on stairs.
- Do not use to pick up flammable or combustible liquids, such as gasoline, or use in areas where they may be present.
- Do not charge the unit outdoors.
- Use only the charger supplied by the manufacturer to recharge.
- Do not incinerate the appliance even if it is severely damaged. The batteries can explode in a fire.
- Do not pick up anything that is burning or smoking, such as cigarettes, matches, or hot ashes.
- Do not use without filter in place.
- Do not use with the dust bin open.
- Do not vacuum up more than very small amounts of fine powders such as flour, talc, plaster or gypsum.

# SAVE THESE INSTRUCTIONS

## CAUTION

To reduce the risk of injury to persons, malfunction, or damage to the product or property when using the appliance, follow basic safety precautions, including the following:

- Do not subject the product to shocks or drop it.
- Secure the product in the charging station when not in use, to avoid it falling over.
- Do not use the product without the filter installed.
- Do not use the product to pick up oils or liquids.
- **Do not clean the product with volatile or organic solvents such as thinners or acetone. Use a soft cloth to clean the product.**
- **Do not put any object other than the product, especially a metallic or magnetic object, on the charging station.**
- Keep the vacuum cleaner moving over the carpet surface at all times to avoid damaging the carpet fibers.
- Take care to avoid pinch points when assembling the product or the charging station.
- **Do not let a child or a pet hang onto the charging station.**
- Follow all applicable state and local codes and regulations when installing the mounting station.
- Do not use the double-sided tape to attach the mounting station on wallpaper.
- Do not apply force or impact to the filter parts or dust bin parts.
- **Do not remove the battery during operation.**



# Product Overview

## Freestanding Installation

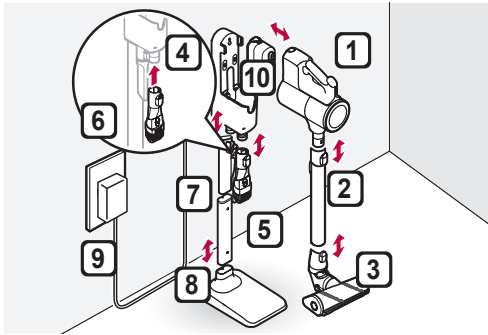

## Wall-Mounted Installation

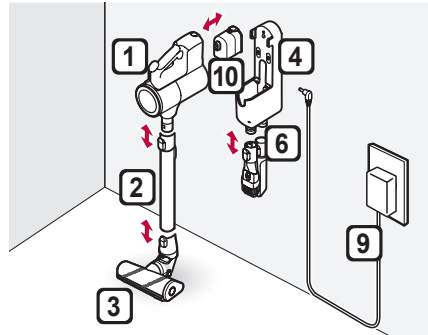

- |                              |   |
|------------------------------|---|
| <b>1</b> Product body        | <b>5</b> Charging station stand               |
| <b>2</b> Extending wand      | <b>6</b> Attachment storage                   |
| <b>3</b> Power Carpet Nozzle | <b>7</b> Detachable nozzle storage (optional) |
| <b>4</b> Charging station    | <b>8</b> Charging station base                |

- |                   |
|-------------------|
| <b>9</b> Adapter  |
| <b>10</b> Battery |

## Included Accessories

- Included accessories may vary based on model purchased.

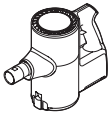

Product body

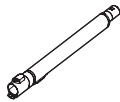

Extension wand

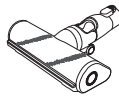

Power Carpet Nozzle

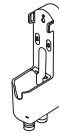

Charging station



Adapter



Battery

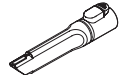

Crevice attachment

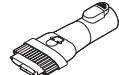

2 in 1 brush/crevice attachment



Wall-anchoring block



Double-sided tape (2)



Wall anchors (2)



Wall anchoring screws (2)



Stand setscrew (Ø 3.5 mm, length 90 mm)



Pre-filter (Spare)



Detachable nozzle storage (optional)

- Please note that these parts come with their corresponding models only.



Battery



Power Floor Nozzle



Power Punch Nozzle

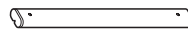

Charging station stand

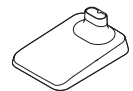

Charging station base

# Installation

## Freestanding Installation

- 1 Assemble the charging station stand by inserting the support pipe into the base. Slide the detachable nozzle storage (optional) and the charging station onto the top of the charging station stand.

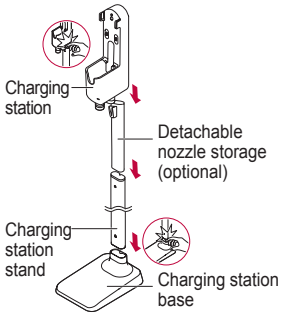

### ⚠ CAUTION

- Avoid getting your fingers stuck in any gaps.
- 2 Insert the power cable into the jack at the back of the charging station. Clip the cord into the cable hook under the jack.
  - Keep the cord tidy by threading it through the anchoring ring on the back of the support pipe.

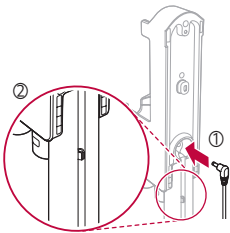

- 3 After ensuring there are no pipes or wires in the way inside the wall, make a hole at the appropriate height to anchor the charging station and insert the wall anchor.
- Recommended diameter of hole:  $\Phi 6.5$ ;  
Recommended depth: 100 mm.

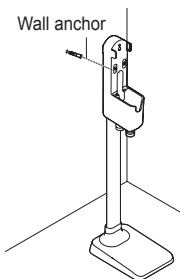

- 4 Put the anchoring block on the back of the charging station and anchor the charging station with the screw.
- Make sure to fully tighten the screw.

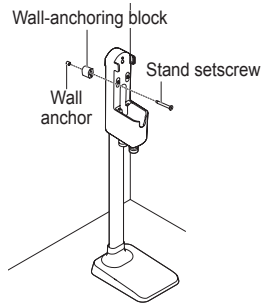

## Using Double-Sided Tape

Do not use this installation method on wallpaper.

- 1 Use double-sided tape to attach the wall anchoring block to the charging station in step 4.
- Discard the center section of one piece of double-sided tape before attaching the tape to the block.

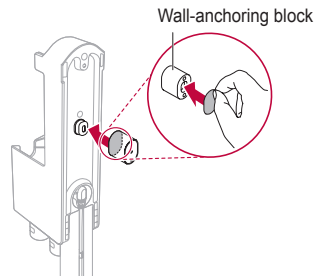

- 2 Use the entire second piece of tape to anchor the station to the wall.

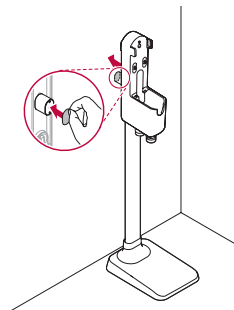

## CAUTION

- To avoid product damage or personal injury, take care not to drop the product parts while unpacking them.
- Do not use the double-sided tape on wallpaper. The weight of the charging station and the product could damage the paper.
- We recommend anchoring the station with the anchoring screw.
- If attaching to concrete or a wall stud, use the setscrew without a wall anchor.
- If attaching to drywall, drill a hole and insert the wall anchor first.

## Note:

- Once assembled, the charging station support and base cannot be disassembled.
- The charging station can be removed as needed. After unscrewing it from the wall, pull the station upward while the bottom of the station remains upright on the floor.

## Wall Installation

- 1 Insert the power cable into the jack at the back of the charging station and plug the power cord into the power outlet.
- 2 Hold the station 3.25 ft (1 m) from the floor and near enough to easily reach the power outlet. Mark the positions of the screw holes on the wall. Insert the wall anchors at the marks, if needed.
  - Recommended diameter of hole:  $\Phi 6.5$ ;
  - Recommended depth: 60 mm.
- 3 Use the 2 shorter wall anchoring screws provided to attach the charging station to the wall.

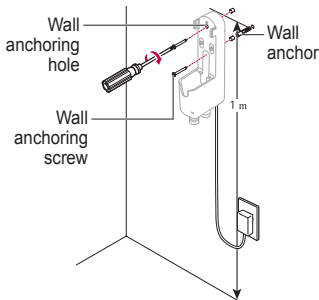

## Note:

- The cost of a service call to properly install the charging station is not covered under the warranty.

## Uninstalling the Station

If the station is not installed, separate the extension pipe and nozzle from the body before storing or charging the product.

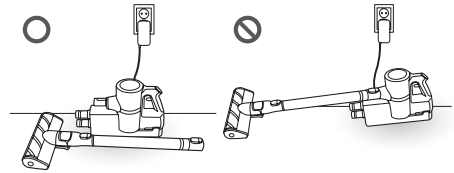

## CAUTION

- Resting the product on a flat surface for a long time with the extension pipe and nozzle attached may damage the product.

## Attachment Storage

When not in use, the crevice and brush attachments can be snapped onto the ports at the bottom of the charging station.

- 1 Attach the combination tool and crevice tool to the dedicated holders.

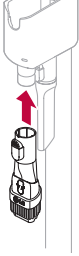

- 2 Press and hold the inlet removal button and pull downward to remove the combination tool or crevice tool.



## Nozzle Storage

When a nozzle is not in use, store it in the convenient detachable nozzle storage (optional) so you can easily find it.

- 1 To store, slide the hook on the nozzle into the cradle.

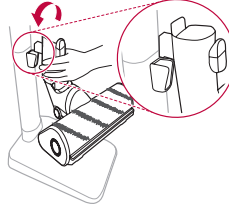

- 2 Lift the nozzle to remove it from the cradle.

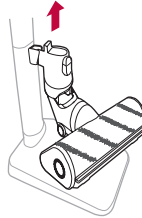

- The nozzle storage cradle is compatible with the Power carpet nozzle.

# Operation

## Before Using

- The dust bin lid must be in place before using the product. Otherwise, the suction strength will deteriorate and cleaning will not be satisfactory.
- Support the bottom of the product when cleaning an elevated surface.
- Store the vacuum in the charging station or flat on the floor when not in use. Leaning the vacuum against a wall or chair can result in product damage or personal injury if the vacuum falls.
- Make sure that the exhaust filter is properly assembled before using the product.
- Environmental conditions such as temperature and humidity may cause occasional static buildup to accumulate on the product. If this is a persistent issue, contact an LG Electronics customer information center.
- Any foreign object on the inlet port or extension pipe will prevent the product from functioning properly. Make sure to remove any foreign object such as a sock or stocking before using the product.
- The battery runtime will be shortened after using the product repeatedly for an extended period due to its characteristics.
- After extended use, all batteries experience reduced battery life.
- The last bar on the battery indicator begins to flash when the battery needs to be recharged.
- Please use the product at normal room temperatures as the battery runtime will deteriorate severely if used at temperatures lower than 41°F (5°C) or higher than 100°F (38°C) for an extended period of time.
- Refer to product specifications for battery run time details.
- These times are a guide only and may be shorter for some surfaces.
- Follow manufacturer's recommendations when cleaning flooring, carpets, and rugs.
- To avoid marking polished flooring, keep the nozzle and brushes free from grit, sand, or abrasive objects.
- To maintain battery life on dual-battery models, swap the positions of the two batteries periodically, between the main body and the auxiliary charging station.

## Attaching the Wand and Accessories

- 1 Attach the wand by sliding it onto the inlet on the product body until it clicks into place. To detach the wand, press the release button. Attach or detach the accessories to the end of the wand in the same way. Insert the battery into the cavity at the back of the vacuum.

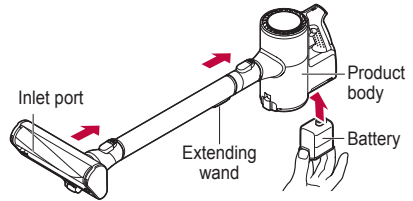

- 2 To extend the wand, press the button on the back of the wand and slide the outer pipe until it clicks into place at the desired length. The wand extends in four steps.

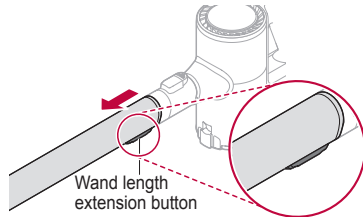

- 3 Accessories can be attached to either the extending wand or the product body.

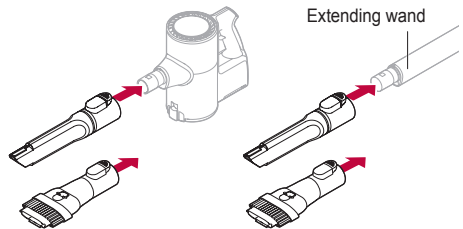

### ⚠ CAUTION

- Do not use attachments to clean TVs, LCDs, or monitors as they may scratch these surfaces.
- Keep fingers away from pinch points when assembling the wand or attachments.
- If any foreign object is sucked into the inlet during cleaning, operation of the vacuum cleaner might stop in order to prevent damage to the body or motor. Immediately stop using the vacuum cleaner and remove the object before resuming cleaning.

## Charging the Battery

- 1 Put the product on the charging station.
  - The battery indicator has 3 bars to indicate the charge level. The bars will flash during charging.

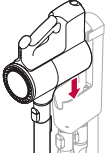

- 2 An auxiliary battery can be charged in the base of the charging station.
  - The auxiliary charge indicator will flash until the auxiliary battery is fully charged.

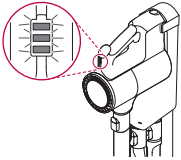

### ⚠ CAUTION

- Make sure to securely fit the unit on to the charging station. Otherwise, the product may fall and get damaged.

### Note:

- The battery will not be charged if the ambient temperature is below 41°F (5°C). Only charge the battery when ambient temperatures are between 41°F (5°C) and 100°F (38°C).
- The battery indicator will turn on if the product is fully charged, removed from the station, and charged again soon. After a few minutes, the indicator turns off.
- If the battery is fully charged, it will not start charging for 24 hours. When the battery is fully charged, 3 bars will be lit on the battery indicator. The indicator turns off a few minutes after the vacuum is placed in the charging station.

## Charging the Auxiliary Battery (Available on select models only)

- 1 Remove the spent battery from the product by pressing in on both sides of the battery and pulling.

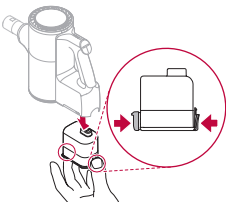

- 2 Insert the battery into the auxiliary charging station.

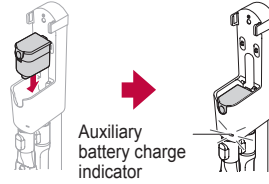

### Note:

- Make sure that the power adapter is connected to both the charging station and the power outlet
- If the main battery is charging on the charging station, the auxiliary battery will only start charging once the main battery is fully charged.
- The auxiliary battery indicator flashes when charging starts.
- The indicator will stay on when the auxiliary battery is fully charged.
- Fully charging a single battery usually takes 3.5 hours. It will take twice as long to charge both the main and auxiliary batteries.

## Adjusting the Suction

Press the Power On/Off button to turn the vacuum on or off.

Press the plus or minus button on the product body to set the suction strength to Standard, Power, or Turbo mode.

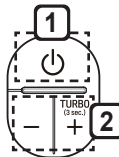

- 1 Power On/Off button

- Press the power On/Off button to activate the Normal mode.

- 2 Mode button

- Press plus (+) to switch to Power mode.
- Press and hold plus (+) to turn on Turbo mode.
- It may take a moment to switch from Normal to Turbo mode.
- Press minus (-) to switch modes from Turbo > Power > Normal.

## Using the Nozzles

- The nozzles included may vary by product.
- The nozzle can be attached to the product body or extension pipe.
- Adjust the suction lower if the inlet gets stuck on the floor, carpet, or power punch or higher if you need more power.

### CAUTION

- Do not use the product for anything other than domestic household purposes.

## Power Carpet Nozzle

- Use to clean carpets or rugs.
- If used on hard flooring, this nozzle will be noisy.

### CAUTION

- Do not use this nozzle on children's PVC play mats.

## Power Floor Nozzle (Available on select models only)

- Use to clean hard floor surfaces.

## Power Punch Nozzle (Available on select models only)

- Power Punch Nozzle lets you clean sheets and bedding more effectively. This attachment can be used to remove pet hair from various surfaces without tangling the hair in the brush.
- Lower the suction level when vacuuming bedding such as duvet covers to avoid the thin fabric getting sucked into the nozzle.

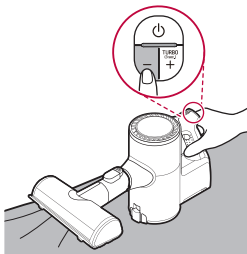

## Crevice Tool

Use to remove dust from corners or narrow spaces.

## Combination Tool

This accessory is helpful for cleaning corners or small gaps.

Use the tool in crevice mode to clean flat surfaces such as sofas or mattresses.

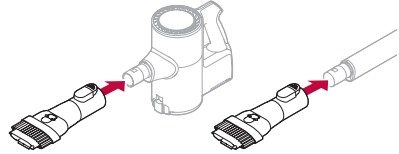

Use the tool in brush mode to clean delicate surfaces such as frames or furniture.

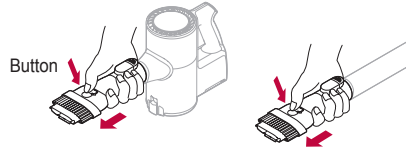

### CAUTION

- Prolonged use of the product with an accessory tool attached may overheat the motor.
- Using this accessory tool on a TV, monitor or LCD display may scratch the screen.
- Avoid getting your finger stuck in any gaps when fitting the accessory tools.
- If any foreign object is sucked into the inlet during cleaning, operation of the unit might stop in order to prevent damage to the body or motor. Immediately stop using the vacuum cleaner and remove the object before resuming cleaning.

## Emptying the Dust Bin

- 1 Remove the battery from the unit before cleaning the dustbin.
- 2 Hold the dust bin over a wastebasket or trash can.
- 3 Press the release button at the bottom front of the dust bin to open the bin and shake to empty it.
  - Be careful as dust/foreign matter may spill out when you open the dustbin.

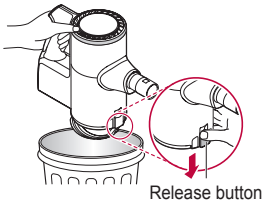

- 4 Insert the crevice tool into the large dust separator and turn it counterclockwise to remove it.

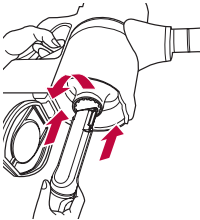

- 5 Rinse the large dust separator under running water and allow to dry completely before reinstalling.
  - Be sure to dry the separator completely before using it.



- 6 With the dust separator removed, use the combination tool to clean out the dust inside the dustbin.

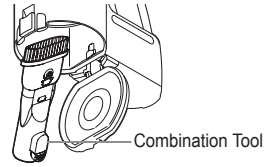

### **⚠ WARNING**

- Never wash the product body with water. Water may reach the motor and cause electric shock or fire.
- Do not apply force or any impact to the dust bin parts or the dust separator as it may damage them.
- Reassemble the dust separator before using the product. Failure to do so will damage the product.

## Cleaning the Filters

The pre-filter and exhaust filter need to be cleaned at least once a month to maintain the cleaning performance of the product. The frequency of cleaning depends on where and how often you use the product. Clean the filters more often if used in areas with a lot of dust.

- 1 Turn the outer exhaust filter counterclockwise to remove it. Lift out the pre-filter by the handle.

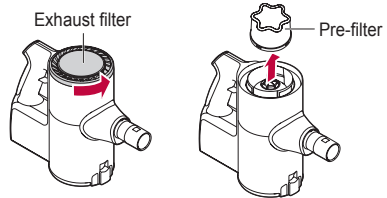

- 2 Use the brush attachment to clean off the motor inside the filter compartment. Do not use water.

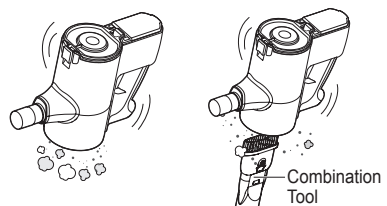



**3** Clean the exhaust filter with a brush or running water.

- To maintain cleaning performance, remove the dust from the exhaust filter at least once a month.



- Allow the exhaust filter to dry out of direct sunlight in a well-ventilated place. Reinstalling the filter before it is completely dry may result in mildew or odor.

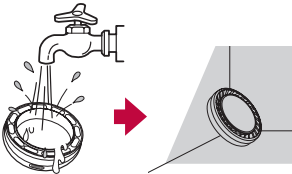

**4** Clean the pre-filter with a brush or running water.

- Allow the pre-filter to dry out of direct sunlight in a well-ventilated place. Reinstalling the filter before it is completely dry may result in mildew or odor.
- The more often the filters are cleaned, the more optimal the suction power will be.
- Filters are consumables. Please purchase more filters from an authorized service center.

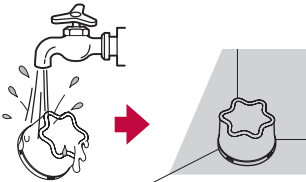

**5** Reassemble the pre-filter first. Then align the exhaust filter with the hollow circle at top and turn the filter clockwise until the solid white circles align.



**⚠ WARNING**

- Never wash the product body or separator with water. Water may reach the motor and cause electric shock or fire.
- Keep foreign objects away from the motor to avoid product damage, explosion or fire.
- Do not insert fingers or sharp objects into the motor enclosure to avoid product damage, personal injury, or electric shock.

**⚠ CAUTION**

- Make sure to reattach the exhaust filter and pre-filter to the product after washing them. Using the product without these filters will allow dust to reach the motor inside the product and cause malfunction.

**Note :**

- Dust buildup reduces the suction power, so for best results, make sure the filters are clean each time you use the product.

**※ Removing foreign objects from inside the product**

In order to maintain product performance, be sure to remove any foreign objects and dust from inside the product (body, extension pipe, inlets). Foreign materials inside the product can cause the product to shut down during operation, generate noise, or cause poor suction.

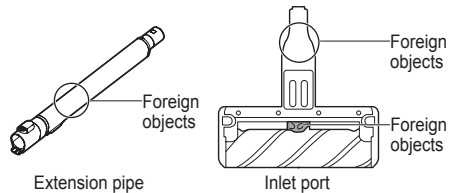
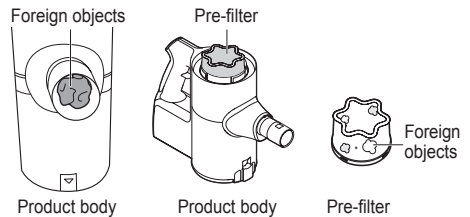

- If the inside of the product body, extension pipe, or inlet port is clogged with foreign objects, the power automatically turns off to protect the product. Separate the battery from the product and remove the foreign objects.

## Cleaning the Power Floor/Carpet Nozzle

Check the brush and roller heads before using and clean as needed.

- 1 Remove the nozzle from the product. Press the release button to remove the head from the wand or product body.
- 2 Turn the head upside down and insert a flat-blade screwdriver in the cover lock slot. Rotate the lock counterclockwise as shown to open the cover.

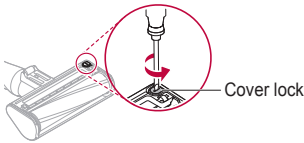

- 3 Rotate the brush cover up and pull the brush out.

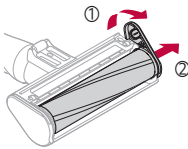

- 4 Attach the crevice tool to the unit and use the vacuum to remove dust/foreign objects from the brush and the bottom of the nozzle.



- 5 Use a wet towel or tissue to remove any remaining foreign matter and dust from the brush and the bottom of the nozzle.



- 6 Slide the brush back into the head and rotate the cover back into place. Turn the cover lock clockwise to lock the cover.

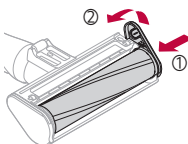

## ⚠ CAUTION

- Keep fingers away from pinch points when removing and assembling the brush.
- Do not immerse the brush or head in water or rinse them in running water.
- Do not pick up oils or liquids with the vacuum.

## Cleaning the Power Punch Nozzle

- 1 Remove the Power Punch Nozzle and turn it upside down.
- 2 Attach the crevice tool to the unit and use the vacuum to remove dust/foreign objects from the bottom of the Power Punch Nozzle.

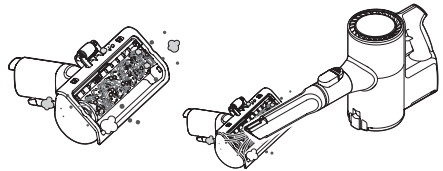

- 3 Use a wet towel or tissue to move any remaining foreign matter and dust.

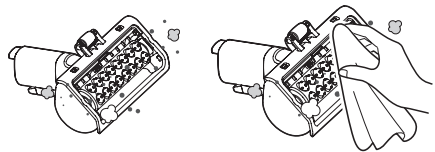

## ⚠ WARNING

- Do not immerse the Power Punch Nozzle in water or rinse it in running water.
- Do not suck any liquids including water into the Power Punch Nozzle.

## Before Calling for Service

Save time and money by checking the following before calling for service.

Symptom	Cause	Solution
The vacuum does not operate.	Battery is dead.	<ul style="list-style-type: none"> <li>Charge the battery.</li> </ul>
	Vacuum is powered off.	<ul style="list-style-type: none"> <li>Press the power button to power on the vacuum.</li> </ul>
Suction is weak.	Dust bin is full.	<ul style="list-style-type: none"> <li>Empty the dustbin.</li> </ul>
	Filter is clogged.	<ul style="list-style-type: none"> <li>Clean the pre-filter. If suction is still weak after cleaning the pre-filter, call for service.</li> </ul>
	Foreign object on brush or in inlet port.	<ul style="list-style-type: none"> <li>Remove foreign objects.</li> </ul>
Vacuum won't charge.	Power adapter is not connected to the charging station.	<ul style="list-style-type: none"> <li>Plug the adapter firmly into the charging station.</li> </ul>
	Power cord is unplugged.	<ul style="list-style-type: none"> <li>Plug the power cord securely into the outlet.</li> </ul>
	Charging terminals are dirty.	<ul style="list-style-type: none"> <li>Clean off the charging terminals with a dry cloth.</li> </ul>
Hot air blowing out of the vacuum.	Motor is cooling.	<ul style="list-style-type: none"> <li>If the vacuum is otherwise running normally, the hot air is from the motor cooling and is normal.</li> </ul>
A strange odor is coming from the vacuum.	The vacuum is less than 3 months old.	<ul style="list-style-type: none"> <li>The cleaner may emit a smell of rubber for about 3 months after purchase.</li> </ul>
	The dust bin is full.	<ul style="list-style-type: none"> <li>The dust in the dust bin may have an odor. Empty the dust bin and clean it.</li> </ul>
	The filter is dirty.	<ul style="list-style-type: none"> <li>Clean the pre-filter and exhaust filter regularly.</li> </ul>
	The pre-filter was installed while damp or wet.	<ul style="list-style-type: none"> <li>Wash the pre-filter thoroughly under running water and allow it to dry completely before reinstalling it.</li> </ul>
	The exhaust filter was installed while damp or wet.	<ul style="list-style-type: none"> <li>Wash the exhaust filter thoroughly under running water and allow it to dry completely before reinstalling it.</li> </ul>
The vacuum is too loud.	Running vacuum in Turbo mode.	<ul style="list-style-type: none"> <li>If the vacuum is otherwise working fine, the noise is likely just from the motor running at high speed.</li> </ul>
The unit powers off too soon.	The battery is not fully charged.	<ul style="list-style-type: none"> <li>Fully charge the battery before using the vacuum. If the problem persists even with a fully charged battery, call for service.</li> </ul>
	The product body, extension wand or nozzle is clogged or dirty.	<ul style="list-style-type: none"> <li>Remove the foreign objects from the product body, Extension wand, or Inlet port.</li> </ul>
The rotating brush does not rotate.	The brush is not installed properly.	<ul style="list-style-type: none"> <li>Remove the brush and reattach it.</li> </ul>
	The brush is clogged or dirty.	<ul style="list-style-type: none"> <li>Remove dirt or foreign objects from the brush.</li> </ul>

# Product Specifications

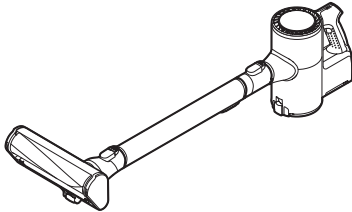

Item/Model	A90****
Exterior dimensions	10.2 in. (W) x 10.6 in. (D) x 44.1 in. (H) 260 mm (W) x 270 mm (D) x 1120 mm (H)
Weight	5.7 lb / 2.7 kg
Power consumption:	400 W (Maximum power: 450 W)/250 W/80 W (Turbo/Power/Standard)
Suction power	140 W <sup>1</sup>
Battery	DC 25.55 V
Battery run time <sup>2</sup> (When fully charged, and without using the Nozzle <sup>3</sup> )	Approx. 6 minutes in Turbo
	Approx. 9 minutes in Power
	Approx. 40 minutes in Standard
Battery run time <sup>2</sup> (When fully charged, and using the Nozzle <sup>3</sup> )	Approx. 6 minutes in Turbo
	Approx. 9 minutes in Power
	Approx. 30 minutes in Standard

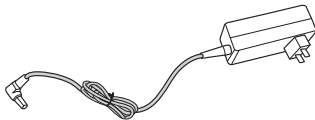

Item	Charger (Adaptor)
Input	100 V - 240 V~ 50/60 Hz, 0.8 A
Output	DC 29.4 V 1.0 A



Item/Model	Battery
Type	Rechargeable Li-ion Battery
Rated	DC 25.55 V , 2000 mAh, 7 cells

1) The result is average of suction power with IEC 62885-2, 5.8 standard tested by individual test lab. Individually measured data would be different from a lab test result.

2) Test result according to our test standard. Results may be different depending on actual use environment and period of use.

3) Floor, carpet, power punch only (suction port may vary by model)

# Warranty

ARBITRATION NOTICE: THIS LIMITED WARRANTY CONTAINS AN ARBITRATION PROVISION THAT REQUIRES YOU AND LG TO RESOLVE DISPUTES BY BINDING ARBITRATION INSTEAD OF IN COURT, UNLESS YOU CHOOSE TO OPT OUT. IN ARBITRATION, CLASS ACTIONS AND JURY TRIALS ARE NOT PERMITTED. PLEASE SEE THE SECTION TITLED "PROCEDURE FOR RESOLVING DISPUTES" BELOW.

LG Electronics Inc. will repair or replace your product, at LG's option, if it proves to be defective in material or workmanship under personal household use, during the warranty period set forth below, effective from the date of original consumer purchase of the product. This limited warranty is good only to the original purchaser of the product and effective only when used in U.S.A. and Canada.

\* Manufacturing Locations : LG Electronics. Changwon Factory2 84, Wanam-ro, Seongsan-gu, Changwon-si, Gyeongsangnam-do, 642-713, KOREA

WARRANTY PERIOD:	HOW SERVICE IS HANDLED:
<b>1 Year</b> From the date of the original purchase	<b>Any part</b> of the Cleaner which fails due to a defect in materials or workmanship. During this <b>full 1 Year warranty</b> , LG will also provide, <b>free of charge</b> , all labor and shop service to replace the defective part. Inverter motor : 10 year warranty (Suction motor)

**THIS WARRANTY IS IN LIEU OF ANY OTHER WARRANTIES, EXPRESS OR IMPLIED, INCLUDING WITHOUT LIMITATION, ANY WARRANTY OF MERCHANTABILITY OR FITNESS FOR A PARTICULAR PURPOSE. TO THE EXTENT ANY IMPLIED WARRANTY IS REQUIRED BY LAW, IT IS LIMITED IN DURATION TO THE EXPRESS WARRANTY PERIOD ABOVE. LG WILL NOT BE LIABLE FOR ANY CONSEQUENTIAL, INDIRECT, OR INCIDENTAL DAMAGES OF ANY KIND, INCLUDING LOST REVENUES OR PROFITS, IN CONNECTION WITH THE PRODUCT. SOME STATES DO NOT ALLOW LIMITATION ON HOW LONG AN IMPLIED WARRANTY LASTS OR THE EXCLUSION OF INCIDENTAL OR CONSEQUENTIAL DAMAGES, SO THE ABOVE LIMITATIONS OR EXCLUSIONS MAY NOT APPLY TO YOU.**

***This warranty covers only defects in material and workmanship.***

***LGE will NOT pay for:***

1. Expendable items that can wear out, including, but not limited to, filters and belts.
2. A service technician to instruct the user in correct product assembly, operation or maintenance.
3. A service technician to clean or maintain this product.
4. Damage to or failure of this product if it is not assembled, operated or maintained according to all instructions supplied with this product.
5. Damage to or failure of this product resulting from accident, abuse, misuse or use for other than its intended purpose.
6. Damage to or failure of this product caused by the use of detergents, cleaners, chemicals or utensils other than those recommended in all instructions supplied with this product.
7. Damage to or failure of parts or systems resulting from unauthorized modifications made to this product.

This warranty is extended to the original purchaser for products purchased for home use within the U.S.A. In Alaska, the warranty excludes the cost of shipping or service calls to your home. Some states do not allow the exclusion or limitation of incidental or consequential damages, so this exclusion or limitation may not apply to you. This warranty gives you specific legal rights, and you may also have other rights which vary from state to state. To know what your legal rights are, consult your local or state consumer affairs or your state's Attorney General.

**CUSTOMER ASSISTANCE INFORMATION:**

<b>To Prove Warranty Coverage</b>	<b>Retain your Sales Receipt to prove date of purchase.</b> A copy of your Sales Receipt must be submitted at the time warranty service is provided.
<b>To Obtain Nearest Authorized Service Center or Sales Dealer, or to Obtain Product, Customer, or Service Assistance</b>	<b>Call 1-800-243-0000</b> (Phone answered 24 hours - 365 days a year) and choose the appropriate prompt from the menu; or visit our website at: <a href="http://us.lgservice.com">http://us.lgservice.com</a> . (In Canada- Call 1-888-542-2623, website <a href="http://ca.lgservice.com">http://ca.lgservice.com</a> )

**PROCEDURE FOR RESOLVING DISPUTES:**

ALL DISPUTES BETWEEN YOU AND LG ARISING OUT OF OR RELATING IN ANY WAY TO THIS LIMITED WARRANTY OR THE PRODUCT SHALL BE RESOLVED EXCLUSIVELY THROUGH BINDING ARBITRATION, AND NOT IN A COURT OF GENERAL JURISDICTION. BINDING ARBITRATION MEANS THAT YOU AND LG ARE EACH WAIVING THE RIGHT TO A JURY TRIAL AND TO BRING OR PARTICIPATE IN A CLASS ACTION.

Definitions. For the purposes of this section, references to "LG" mean LG Electronics U.S.A., Inc., its parents, subsidiaries and affiliates, and each of their officers, directors, employees, agents, beneficiaries, predecessors in interest, successors, assigns and suppliers; references to "dispute" or "claim" shall include any dispute, claim or controversy of any kind whatsoever (whether based in contract, tort, statute, regulation, ordinance, fraud, misrepresentation or any other legal or equitable theory) arising out of or relating in any way to the sale, condition or performance of the product or this Limited Warranty.

**Notice of Dispute.** In the event you intend to commence an arbitration proceeding, you must first notify LG in writing at least 30 days in advance of initiating the arbitration by sending a letter to LG at LG Electronics, USA, Inc. Attn: Legal Department- Arbitration 1000 Sylvan Ave, Englewood Cliffs 07632. You and LG agree to engage in good faith discussions in an attempt to amicably resolve your claim. The notice must provide your name, address, and telephone number; identify the product that is the subject of the claim; and describe the nature of the claim and the relief being sought. If you and LG are unable to resolve the dispute within 30 days, either party may proceed to file a claim for arbitration.

**Agreement to Binding Arbitration and Class Action Waiver.** Upon failure to resolve the dispute during the 30 day period after sending written notice to LG, you and LG agree to resolve any claims between us only by binding arbitration on an individual basis, unless you opt out as provided below. Any dispute between you and LG shall not be combined or consolidated with a dispute involving any other person's or entity's product or claim. More specifically, without limitation of the foregoing, any dispute between you and LG shall not under any circumstances proceed as part of a class or representative action. Instead of arbitration, either party may bring an individual action in small claims court, but that small claims court action may not be brought on a class or representative basis.

**Arbitration Rules and Procedures.** To begin arbitration of a claim, either you or LG must make a written demand for arbitration. The arbitration will be administered by the American Arbitration Association ("AAA") and will be conducted before a single arbitrator under the AAA's Consumer Arbitration Rules that are in effect at the time the arbitration is initiated (referred to as the "AAA Rules") and under the procedures set forth in this section. The AAA Rules are available online at [www.adr.org/consumer](http://www.adr.org/consumer). Send a copy of your written demand for arbitration, as well as a copy of this provision, to the AAA in the manner described in the AAA Rules. You must also send a copy of your written demand to LG at LG Electronics, USA, Inc. Attn: Legal Department- Arbitration 1000 Sylvan Avenue Englewood Cliffs, NJ 07632. If there is a conflict between the AAA Rules and the rules set forth in this section, the rules set forth in this section will govern. This arbitration provision is governed by the Federal Arbitration Act. Judgment may be entered on the arbitrator's award in any court of competent jurisdiction. All issues are for the arbitrator to decide, except that issues relating to the scope and enforceability of the arbitration provision and to the arbitrability of the dispute are for the court to decide. The arbitrator is bound by the terms of this provision.

**Governing Law.** The law of the state of your residence shall govern this Limited Warranty and any disputes between us except to the extent that such law is preempted by or inconsistent with applicable federal law.

**Fees/Costs.** You do not need to pay any fee to begin an arbitration. Upon receipt of your written demand for arbitration, LG will promptly pay all arbitration filing fees to the AAA unless you seek more than \$25,000 in damages, in which case the payment of these fees will be governed by the AAA Rules. Except as otherwise provided for herein, LG will pay all AAA filing, administration and arbitrator fees for any arbitration initiated in accordance with the AAA Rules and this arbitration provision. If you prevail in the arbitration, LG will pay your attorneys' fees and expenses as long as they are reasonable, by considering factors including, but not limited to, the purchase amount and claim amount. Notwithstanding the foregoing, if applicable law allows for an award of reasonable attorneys' fees and expenses, an arbitrator can award them to the same extent that a court would. If the arbitrator finds either the substance of your claim or the relief sought in the demand is frivolous or brought for an improper purpose (as measured by the standards set forth in Federal Rule of Civil Procedure 11(b)), then the payment of all arbitration fees will be governed by the AAA Rules. In such a situation, you agree to reimburse LG for all monies previously disbursed by it that are otherwise your obligation to pay under the AAA Rules. Except as otherwise provided for, LG waives any rights it may have to seek attorneys' fees and expenses from you if LG prevails in the arbitration.

**Hearings and Location.** If your claim is for \$25,000 or less, you may choose to have the arbitration conducted solely on the basis of (1) documents submitted to the arbitrator, (2) through a telephonic hearing, or (3) by an in-person hearing as established by the AAA Rules. If your claim exceeds \$25,000, the right to a hearing will be determined by the AAA Rules. Any in-person arbitration hearings will be held at a location within the federal judicial district in which you reside unless we both agree to another location or we agree to a telephonic arbitration.

**Opt Out.** You may opt out of this dispute resolution procedure. If you opt out, neither you nor LG can require the other to participate in an arbitration proceeding. To opt out, you must send notice to LG no later than 30 calendar days from the date of the first consumer purchaser's purchase of the product by either: (i) sending an e-mail to [optout@lge.com](mailto:optout@lge.com), with the subject line: "Arbitration Opt Out" or (ii) calling 1-800-980-2973. You must include in the opt out e-mail or provide by telephone: (a) your name and address; (b) the date on which the product was purchased; (c) the product model name or model number; and (d) the serial number (the serial number can be found (i) on the product; or (ii) online by accessing <https://www.lg.com/us/support/repair-service/schedule-repair-continued> and clicking on "Find My Model & Serial Number").

You may only opt out of the dispute resolution procedure in the manner described above (that is, by e-mail or telephone); no other form of notice will be effective to opt out of this dispute resolution procedure. Opting out of this dispute resolution procedure will not affect the coverage of the Limited Warranty in any way, and you will continue to enjoy the full benefits of the Limited Warranty. If you keep this product and do not opt out, then you accept all terms and conditions of the arbitration provision described above.

LG CordZero™