

ASSEMBLY INSTRUCTION
ITEM#: S-BS1147SST-B

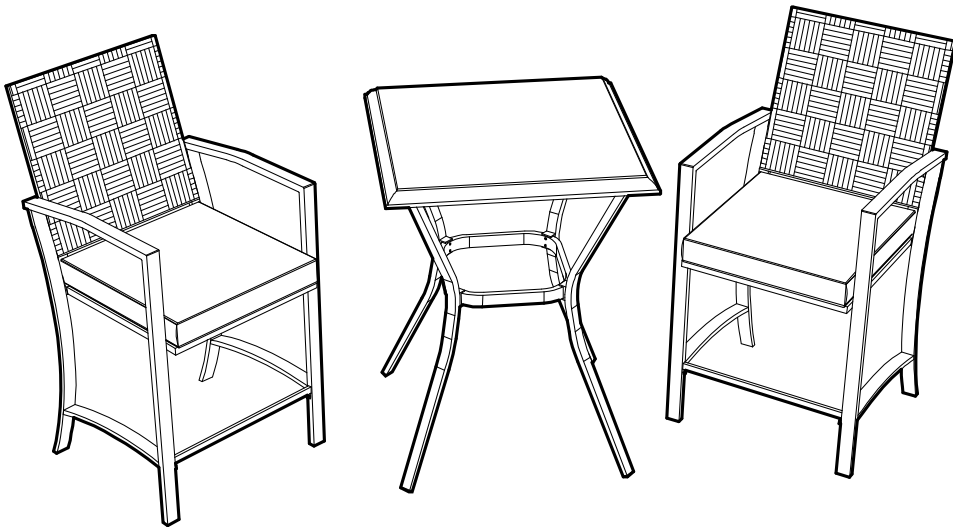

For any questions or issues about our product

Call Sunjoy Customer Service

1(866) 578 - 6569

Anytime 24 hours / 7 days a week

Safety Information

- Please follow the simple step-by-step assembly Instructions.
- Check and ensure all the parts, fittings and hardware are present before discarding any packaging.
- One or two people are required for this assembly.
- Please read all instructions carefully before assembly and usage. Basic safety precautions should always be followed to reduce the risk of personal injury and damage to equipment.
- Advisable to wear protective gloves during assembly.
- Assemble this product on the flat surface.
- Assemble all parts loosely before tightening any bolts.
- Retain this Assembly Instruction for future reference.



CAUTION: Do not climb on top of the product. Falling off the product may result in serious injury.

NOTICE: For outdoor and indoor use

Warranty: 1 Year

WHAT IS COVER?

The limited warranty is extended to the original purchaser and applies to material and manufacturer's defect provided the item is maintained with care and used only for personal, residential purposes.

IMPORTANT

KEEP THIS INSTRUCTION MANUAL FOR FUTURE REFERENCE.

ONE OR TWO PERSON IS/ARE NEEDED FOR THE INSTALLATION WORK.

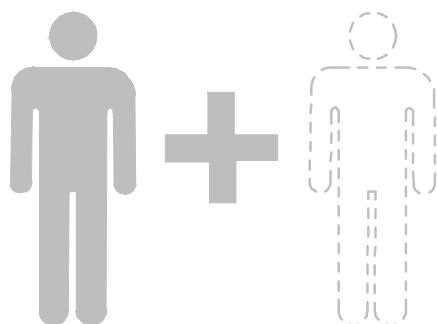





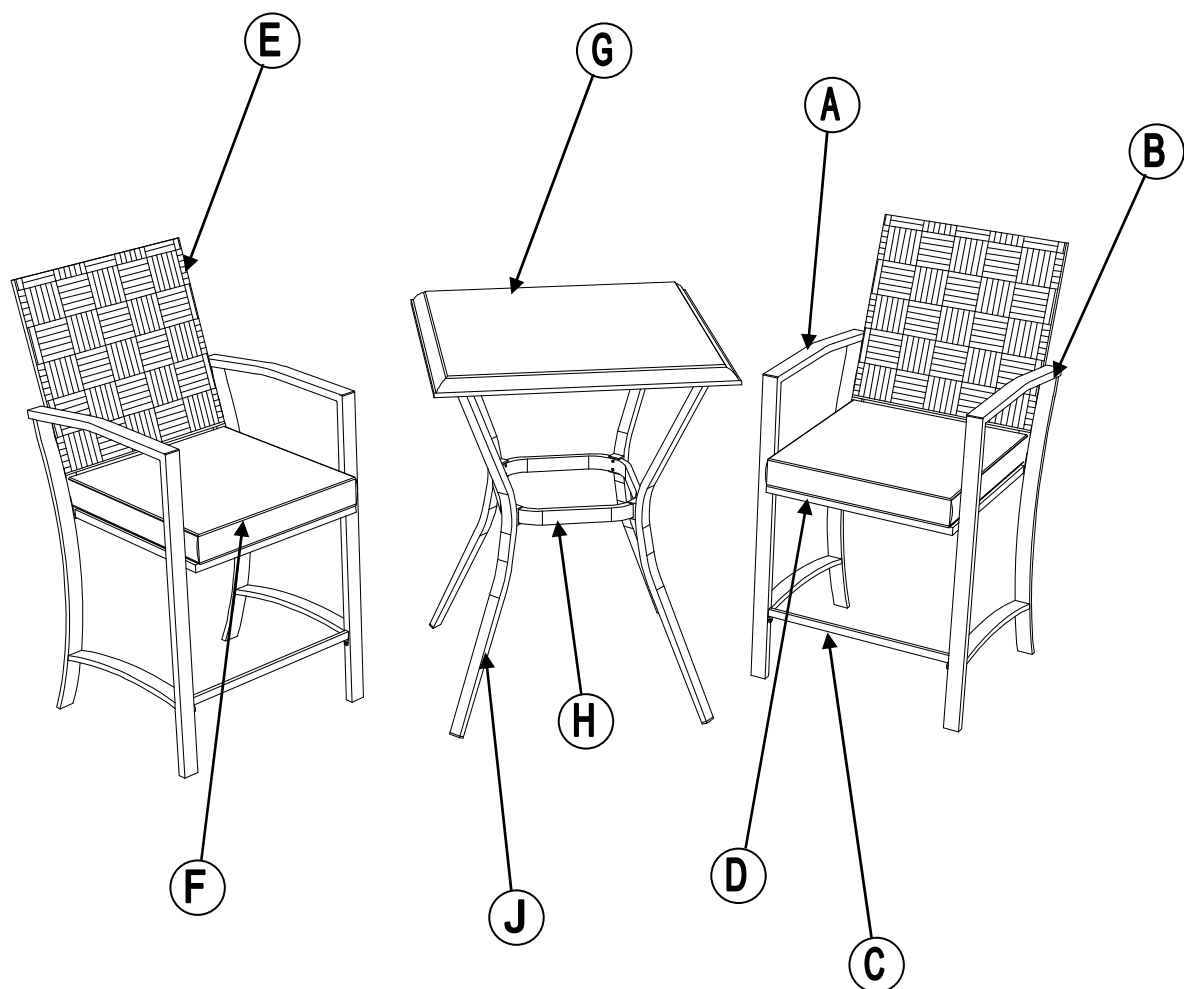

Country of Origin: China

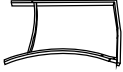
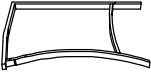
Call 1(866) 578-6569 for assistance.
Or visit us at www.sunjoyonline.com

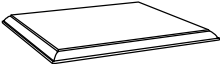

EXPLODED DRAWING

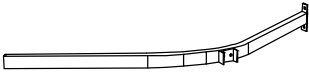

Parts List				
Label	Part Number	Description	Qty	Part Image
A	P30019A01138	Handrail (Left)	2	
B	P30020A01138	Handrail (Right)	2	
C	P31901A01138	Support Pipe For Foot	2	
D	P30209A01138	Seat	2	
E	P30109A06138	Back	2	
F	P00401F04107	Cushion	2	
G	P31307A01138	Table Top	1	
H	P31507A01138	Fixed Frame	1	
J	P31407A01138	Leg	4	

Country of Origin: China

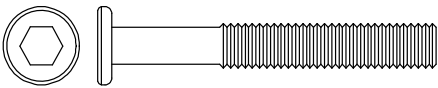
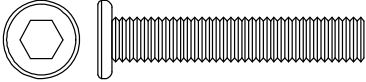
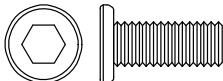
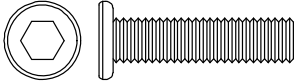
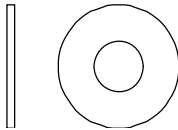
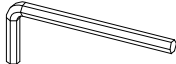
Call 1(866) 578-6569 for assistance.
Or visit us at www.sunjoyonline.com

Hardware Pack					
Label	Part Number	Description	Qty	Add	Part Image
AA	H04045C11	Bolt M6*45	8	1	
BB	H04035C11	Bolt M6*35	4	1	
CC	H04015C11	Bolt M6*15	16	2	
DD	H04030C11	Bolt M6*25	8	1	
EE	H12001C11	Flat Washer M6	36	3	
FF	H00002C12	Allen Key Size 4	1	0	
GG	H13001C11	M6 Spring Washer	36	3	
HH	P91002A07001	Food pad (preassembled)	4	0	

Country of Origin: China

Call 1(866) 578-6569 for assistance.
Or visit us at www.sunjoyonline.com

STEP 1: Assembly of Handrail and Back

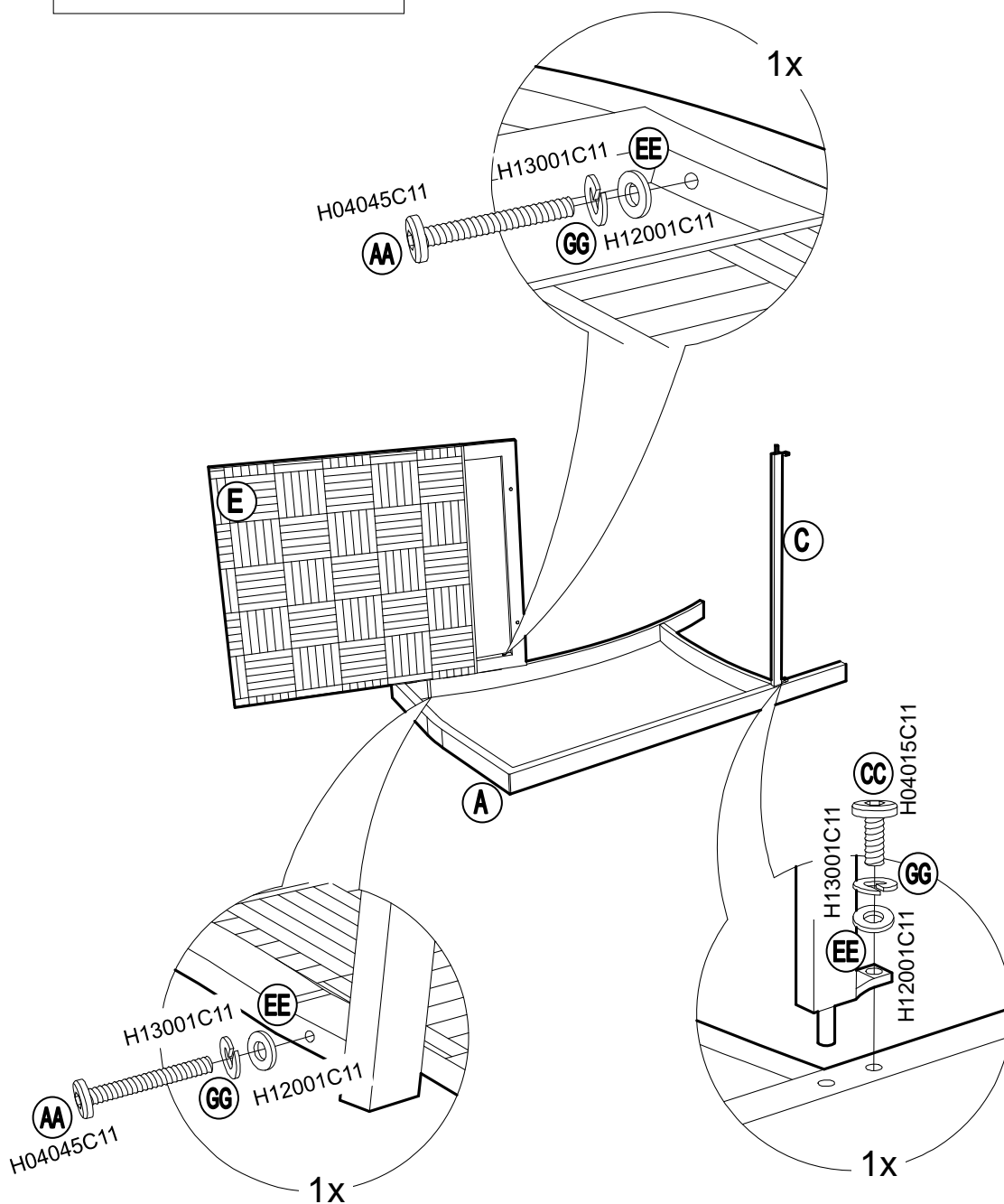
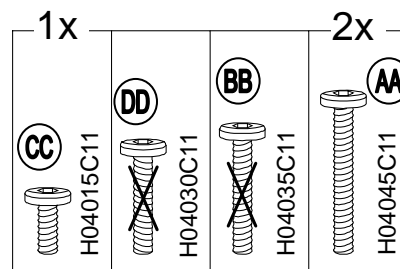
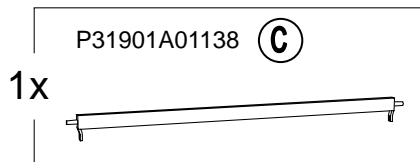
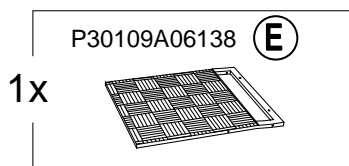
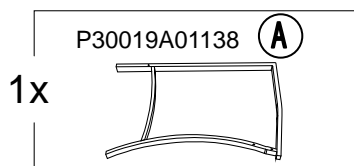

STEP 3: Assembly of Handrail

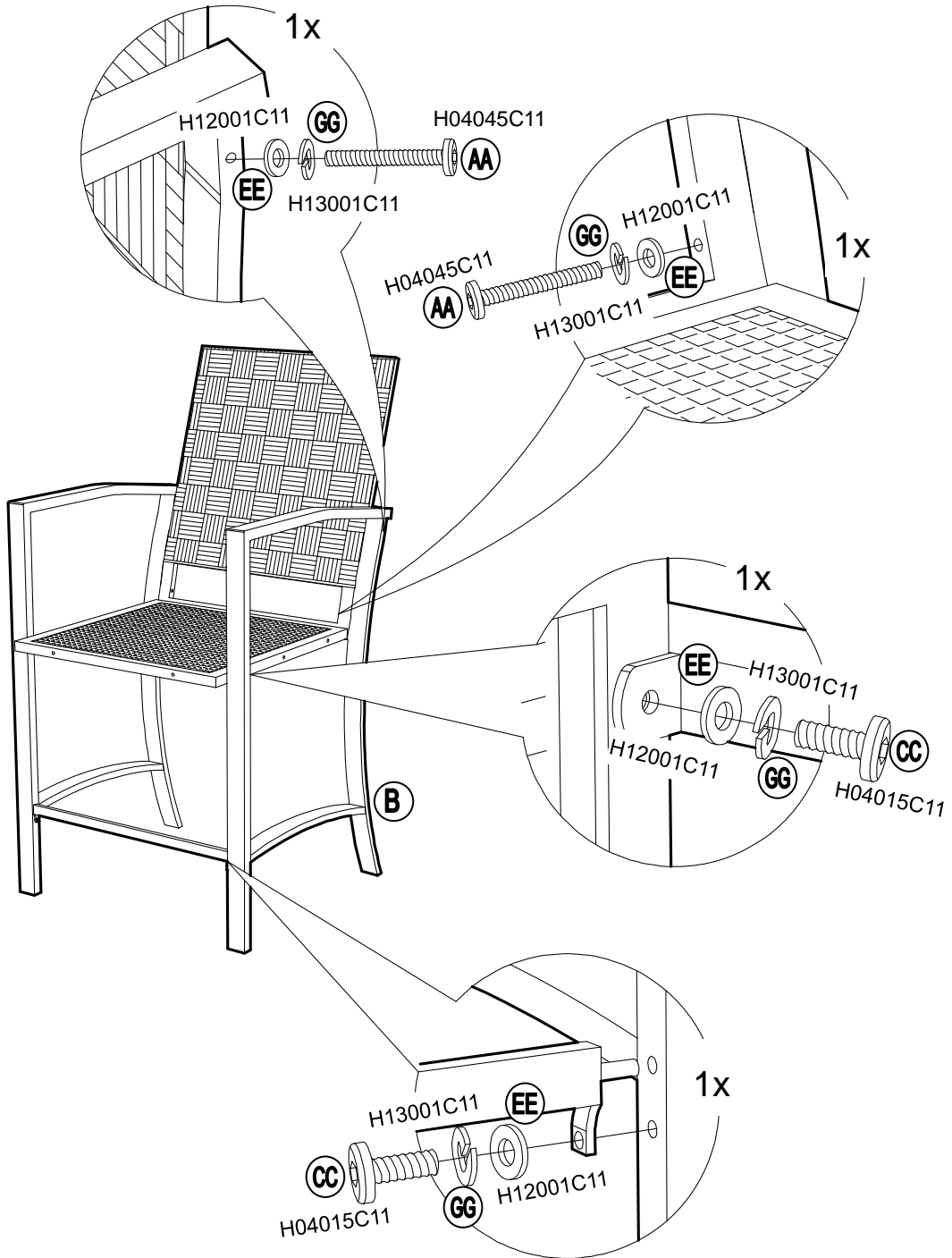
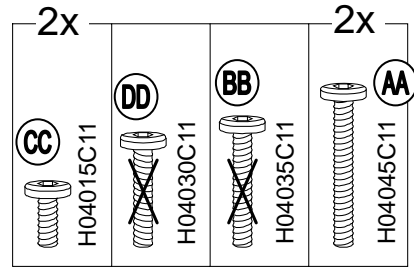
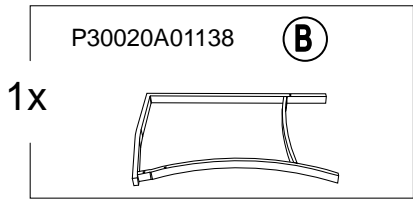

STEP 4: Assembly of Cushion

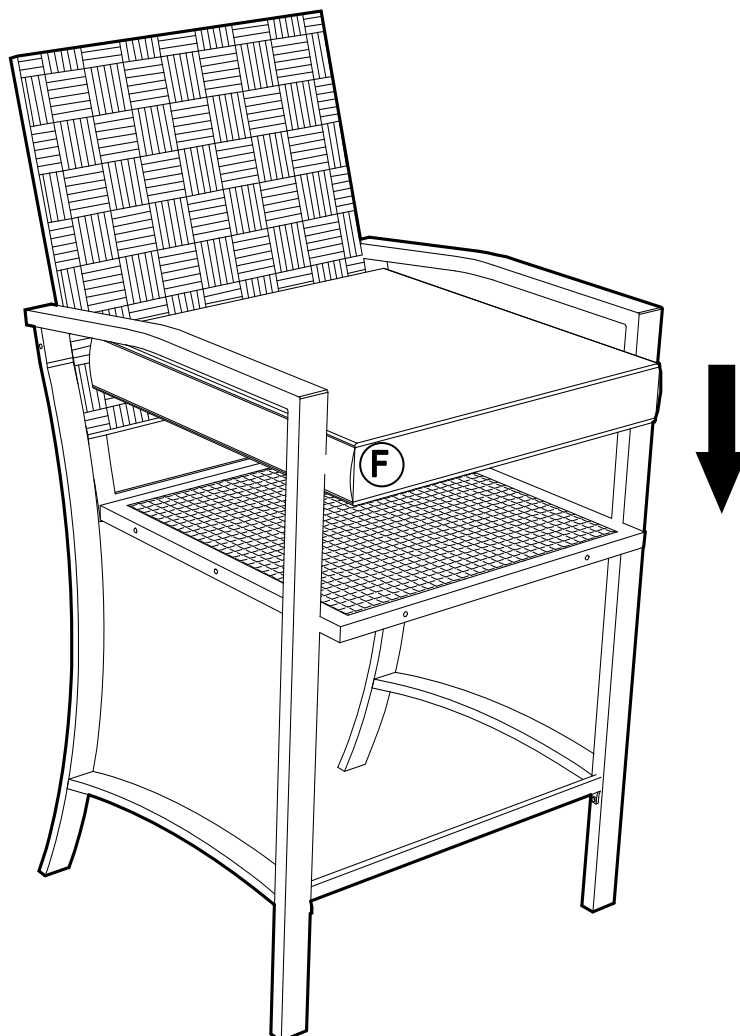
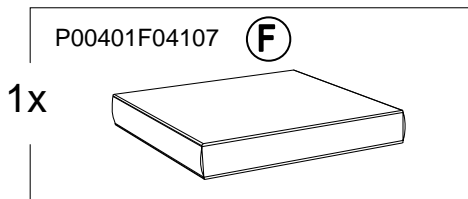

STEP 5: Assembly of Fixed Frame and Leg

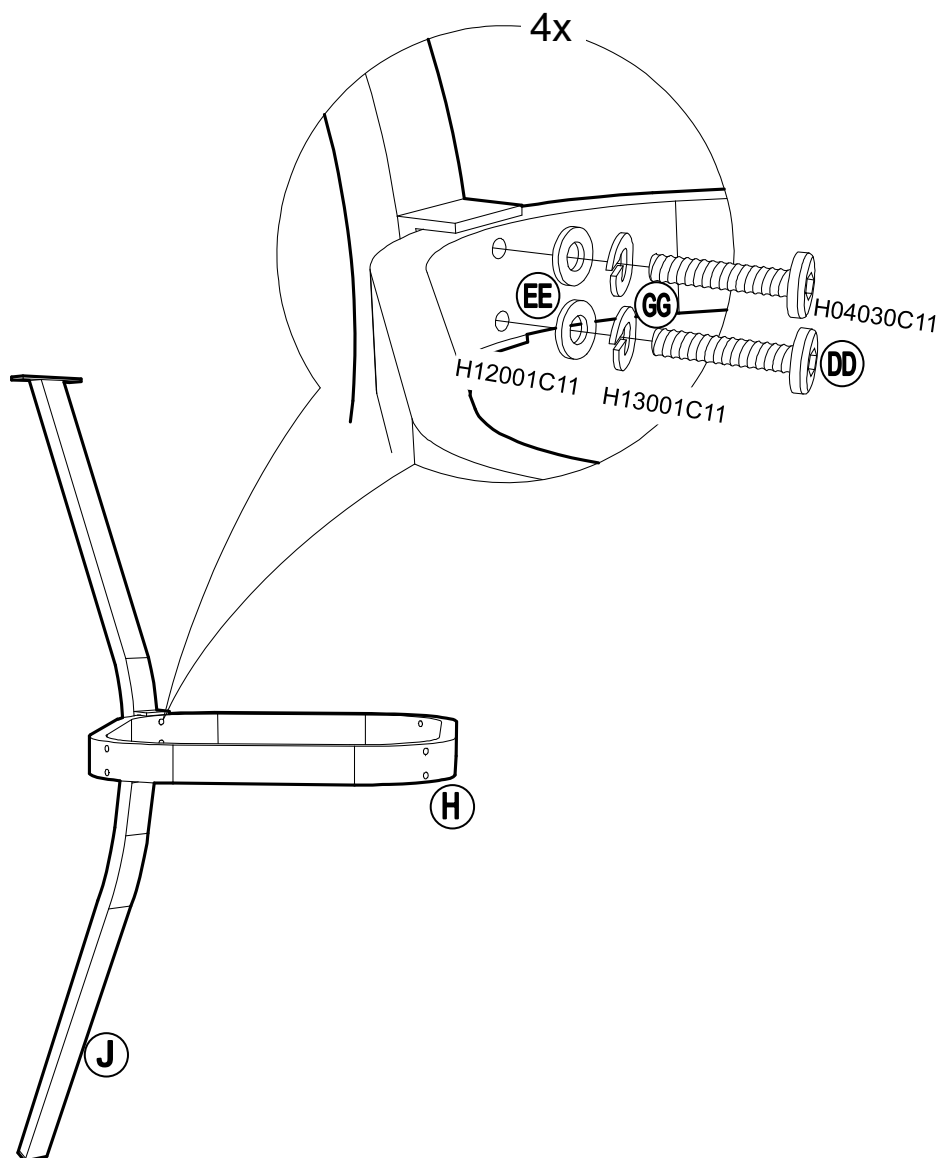
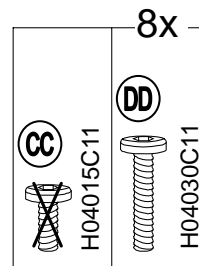
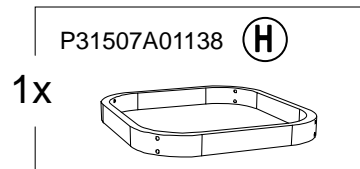
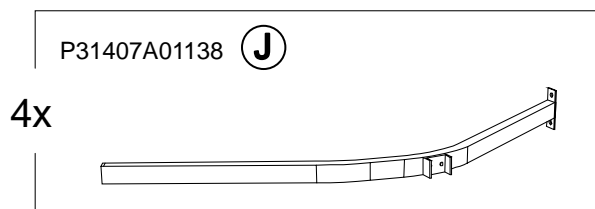

STEP 6: Assembly of Table Top

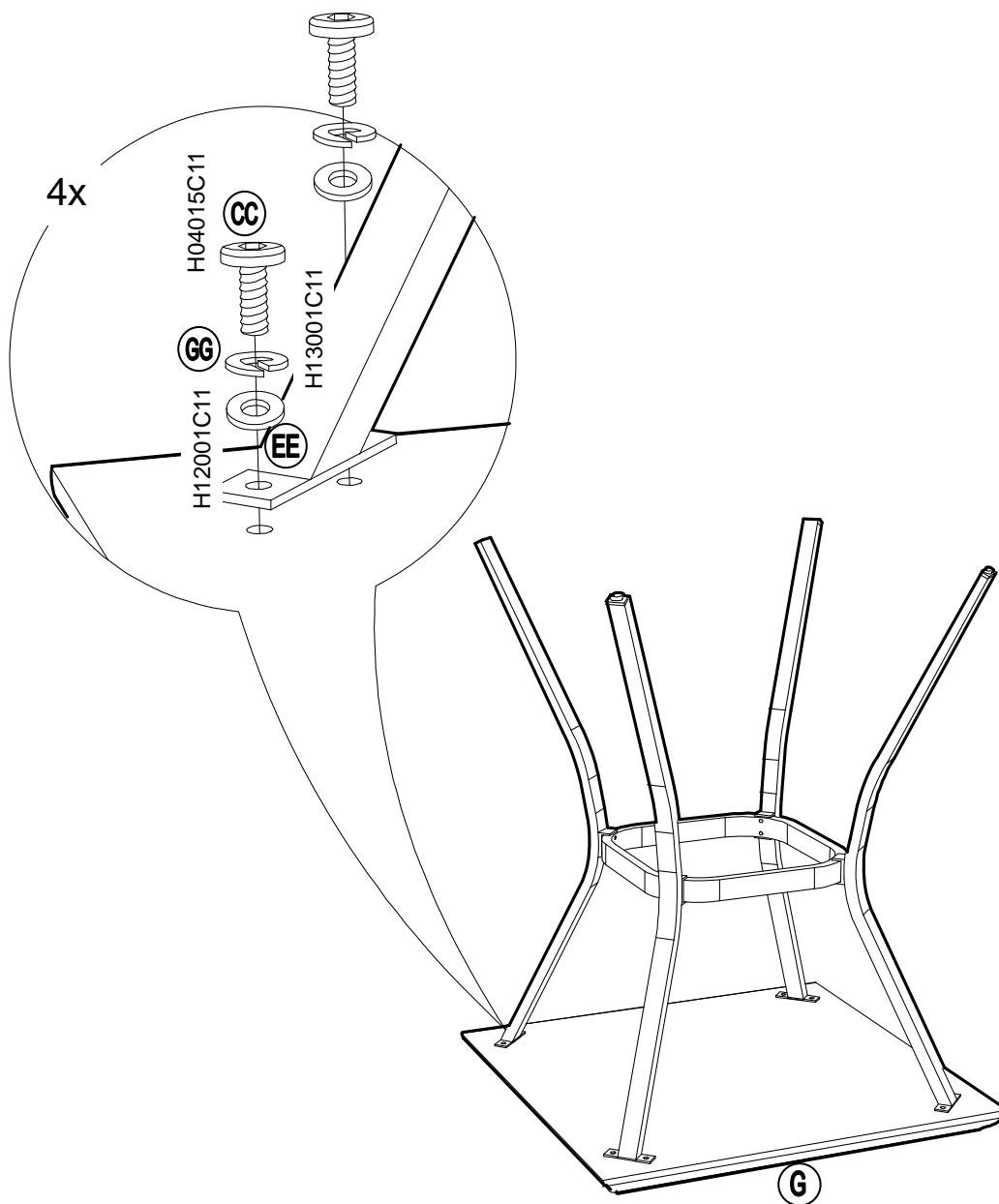
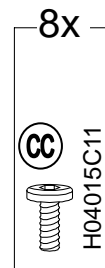
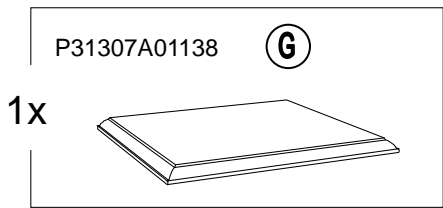

STEP 7: Ready for use

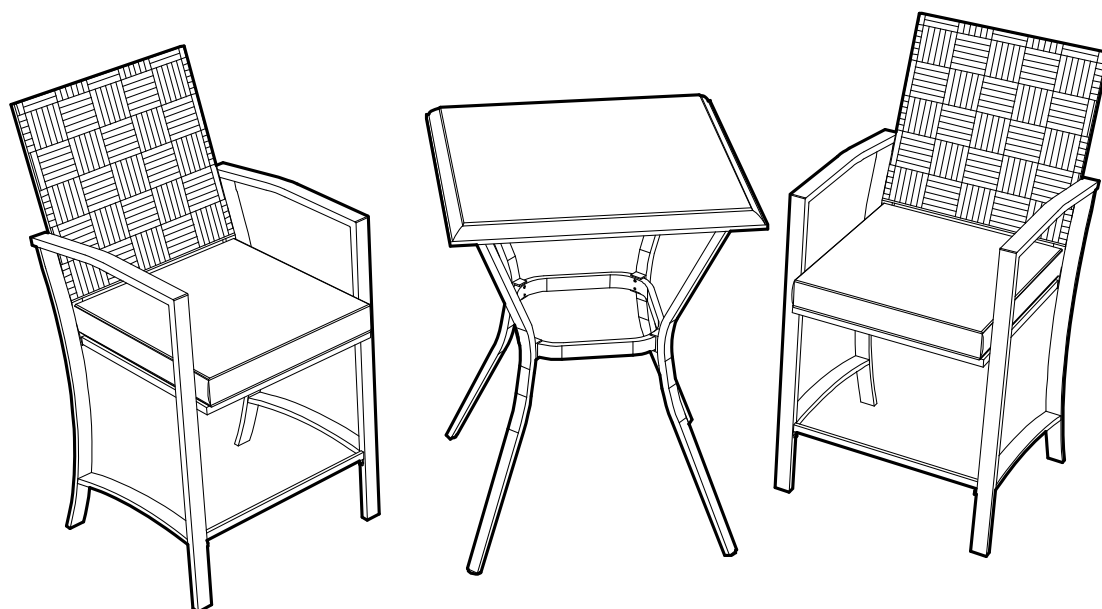

Country of Origin: China

Call 1(866) 578-6569 for assistance.
Or visit us at www.sunjoyonline.com

Care and Maintenance

- Use damp cloth to wipe off the stains on the rattan as quickly as possible.
- If necessary, wash with a mild solution of soap and water; rinse thoroughly and dry completely.
- Gently apply vacuum cleaner on the fibres of rattan and cushion surface to remove the dust. A soft brush is also good to remove the dust on the surface
- The cushions & pillows' fabric of outdoor furniture is water resistant. If the cushions & pillows is wet leave it to dry naturally under in the sun or uses a dryer to dry it.
- Only wash the cushions & pillows with non-scouring pH-neutral detergent when it's really necessary to do so, leave to dry completely before use
- When not in use, they should be stored in a dry cool place.

Limited Manufacturer's Warranty

Sunjoy Group warrants to the original purchaser that this item is free from defects in workmanship and materials for a period of **1 year** from the date of purchase, provided the item was factory-sealed at the time of purchase and is maintained with care and used only for personal, residential purposes. Should any manufacturing defect arise within this warranty period, Sunjoy Group will replace (at our option) any defective merchandise or parts upon proof of purchase; however, transportation and delivery costs, as well as payments to a third party for assembly or disassembly of the item, remain the responsibility of the purchaser. A purchaser of an "open box," previously-returned, or "clearance" item, as well as original purchasers outside of the warranty period, may obtain replacement parts from Sunjoy Group for products in current production, at nominal cost.

Exclusions:

Items used for commercial, contract, or other non-residential purposes, or items damaged due to acts of nature, vandalism, misuse, or improper assembly are not covered. Corrosion or rusting of hardware is not covered. Proof of purchase (dated register receipt) is required for warranty claims. Warranty is to the original purchaser and is non-transferable. Any replacement of warranted items will be in the original style and color, or a similar style and color if the original is unavailable or has been discontinued. As some states do not allow exclusions or limitations on an implied warranty, the above exclusions and limitations may not apply. This warranty gives you specific rights, and you may also have other rights, which vary from state to state.