



ZLINE



# OVER THE RANGE MICROWAVE

---

Installation Guide  
and Users Manual



*This product can expose you to chemicals including nickel, which is known to the State of California to cause cancer, and birth defects or other reproductive harm. For more information go to [www.P65Warnings.ca.gov](http://www.P65Warnings.ca.gov).*

*Even though the materials used in all ZLINE Kitchen and Bath products conform to all federal government regulations and all national product standards, California's Prop 65 requires all businesses to provide a "clear and reasonable warning" if one or more listed chemicals may be present in the product, even if that chemical is present in trace quantities*



ZLINE

# CONTENTS

● PRECAUTIONS	1
● IMPORTANT SAFETY INSTRUCTIONS	2
● ELECTRICAL REQUIREMENTS	4
● PARTS AND TOOLS	6
● INSTALLATION	9
● RADIO INTERFERENCE	29
● UTENSILS	30
● DIFFERENT MATERIALS IN THE MICROWAVE	31
● SETTING UP YOUR OVEN	32
● OPERATION	33
● TROUBLESHOOTING	49

## PRECAUTIONS

- Do not attempt to operate this oven with the door open since open-door operation can result in harmful exposure to microwave energy. It is important not to defeat or tamper with the safety interlocks.
- Do not place any object between the oven front face and the door or allow soil or cleaner residue to accumulate on sealing surfaces.
- Do not operate the oven if it is damaged. It is particularly important that the oven door closes properly and that there is no damage to the:
  - Door (bent or not closing)
  - Hinges and Latches (broken or loosened)
  - Door seals and sealing surfaces (wear and tear)

## IMPORTANT SAFETY INSTRUCTIONS



When using electrical appliances basic safety precautions should be followed, including the following:

- To reduce the risk of burns, electric shock, fire, personal injury, or exposure to excessive microwave energy, read all instructions before using the appliance.
- This appliance must be grounded or connected to a properly grounded outlet. Install this appliance only in accordance with the provided installation instructions.
- Some products such as whole eggs and sealed containers (i.e. closed glass jars) should not be heated in this oven.
- Use this appliance only for its intended use as described in the manual. Do not use corrosive chemicals or vapors in this appliance. This type of oven is specifically designed to heat, cook, or dry food.
- Close supervision is necessary when used by children.
- Do not operate this appliance if it has a damaged cord or plug, if it is not working properly, or if the entire unit has been damaged.
- This appliance should be serviced only by qualified service personnel.
- Do not cover or block any openings on the appliance.
- Do not store this appliance outdoors. Do not use this product near water - for example, near a kitchen sink, in a wet basement, near a swimming pool, or similar locations.
- Do not immerse cord or plug in water.
- Keep cord away from heated surface.
- Do not let cord hang over edge of table or counter.
- When cleaning surfaces of door and oven that comes together on closing the door, use only mild, nonabrasive soaps, or detergents applied with a sponge or soft cloth.
- To reduce the risk of fire in the oven cavity:
  - Do not overcook food. Carefully attend appliance when paper, plastic, or other combustible materials are placed inside the oven to facilitate cooking.
  - Remove wire twist-ties from paper or plastic bag before placing bag in oven.
  - If material inside of the oven ignite, keep oven door closed, turn oven off, and disconnect the power cord, or shut off power at the fuse or circuit breaker panel.
  - Do not use the cavity for storage purposes. Do not leave paper products, cooking utensils, or food in the cavity when not in use.
- Liquids and other foods must not be heated in sealed containers since they are liable to explode.

## IMPORTANT SAFETY INSTRUCTIONS

- To reduce the risk of injury to persons
  - Do not overheat the liquid.
  - Stir the liquid both before and halfway through heating it.
  - Do not use straight-sided containers with narrow necks.
  - After heating, allow the container to stand in the microwave oven for a short time before removing the container.
  - Use extreme care when inserting a spoon or other utensil into the container.
- Do not operate any heating or cooking appliance beneath, over, or near the appliance. It is okay to use the microwave above another heating appliance.
- Suitable for use above both gas and electric cooking equipment.
- Do not mount over sink.
- Do not store anything directly on top of the appliance surface when the appliance is in operation.
- Clean ventilation hoods frequently - Grease should not be allowed to accumulate on hood or filter.
- Use care when cleaning the vent-hood filter. Corrosive cleaning agents may damage the filter.

# ELECTRICAL REQUIREMENTS



Improper use of the grounding can result in a risk of electric shock.

## Electric Shock Hazard

- Consult a qualified electrician if the grounding instructions are not completely understood or if doubt exists as to whether the appliance is properly grounded. If it is necessary to use an extension cord, use only a 3-wire extension cord that has a 3-blade grounded plug and 3-slot receptacle that will accept the plug on the appliance. The marked rating of the extension cord shall be equal to or greater than the electrical rating of the appliance.
- A short power supply cord is provided to reduce the risks resulting from becoming entangled in or tripping over a longer cord. Longer cord sets or extension cords are available and may be used if care is exercised in their use.
- If a long cord or extension cord is used:
  - The marked electrical rating of the cord set or extension cord should be at least as great as the electrical rating of the appliance.
  - The extension cord must be a grounding-type 3-wire cord.
  - The longer cord should be arranged so that it will not drape over the counter top or tabletop where it can be pulled on by children or tripped over unintentionally.
- Touching some of the internal components can cause serious personal injury or death. Do not disassemble this appliance.
- Do not plug this unit into an outlet until it is properly installed and grounded.





# ELECTRICAL REQUIREMENTS

- This product requires a three-prong grounded outlet. The installer must perform a ground continuity check on the power outlet box before beginning the installation to ensure that the outlet box is properly grounded. If not properly grounded, or if the outlet box does not meet electrical requirements noted, a qualified electrician should be employed to correct any deficiencies.
- For personal safety, remove house fuse or open circuit breaker before beginning installation to avoid severe or fatal shock injury. *Figure 1*
- For personal safety, the mounting surface must be capable of supporting the cabinet load, in addition to the added weight of this 63–85 pound (28.5–38.5 kg) product, plus additional oven loads of up to 50 pounds (22.7 kg) or a total weight of 113–135 pounds (51.3–61.2 kg).
- For personal safety, this product cannot be installed in cabinet arrangements such as an island or a peninsula. It must be mounted to BOTH a top cabinet AND a wall.
- **IMPORTANT – PLEASE READ CAREFULLY. FOR PERSONAL SAFETY, THIS APPLIANCE MUST BE PROPERLY GROUNDED TO AVOID SEVERE OR FATAL SHOCK.**
- The power cord of this appliance is equipped with a three-prong (grounding) plug which mates with a standard three-prong (grounding) wall receptacle to minimize the possibility of electric shock hazard from this appliance. *Figure 2*
- You should have the wall receptacle and circuit checked by a qualified electrician to make sure the receptacle is properly grounded.
- Where a standard two-prong wall receptacle is encountered, it is very important to have it replaced with a properly grounded three-prong wall receptacle, installed by a qualified electrician.
- **DO NOT UNDER ANY CIRCUMSTANCES, CUT, DEFORM OR REMOVE ANY OF THE PRONGS FROM THE POWER CORD. DO NOT USE WITH AN EXTENSION CORD.**

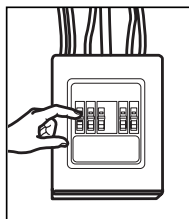

Figure 1

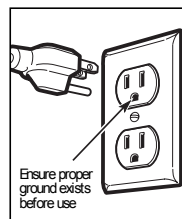





Figure 2

# PARTS AND TOOLS

Before starting on the installation, prepare all the necessary tools and parts required to install the microwave. This will save installation time and simplify the installation process.

## PARTS INCLUDED









### HARDWARE PACKET

PART		QUANTITY
	Wood Screws ( $\frac{1}{4}$ " x 2")	2
	Toggle Bolts (and wing nuts) ( $\frac{5}{16}$ " x 3")	2
	Self-Aligning Machine Screws ( $\frac{1}{4}$ "-28 x $\frac{3}{4}$ " )	3
	Nylon Grommet (for metal cabinets)	1

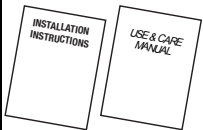
You will find the installation hardware contained in a packet with the unit. Check to make sure you have all these parts.

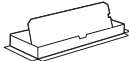
NOTE: Some extra parts are included.

## PARTS INCLUDED (CONT.) ADDITIONAL PARTS

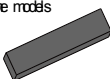
PART		QUANTITY
	Top Cabinet Template	1
	Rear Wall Template	1
	Installation Instructions	1
	Use & Care Manual	1
	Separately Packed Grease Filters	2
	Exhaust adaptor	1
	Glass Tray	1
	Turntable Ring	1
For some models 	Convection wire rack	1
For some models 	Shelf	1
For some models 	PureAir® Microwave Filter	1

# PARTS AND TOOLS

## TOOLS YOU WILL NEED

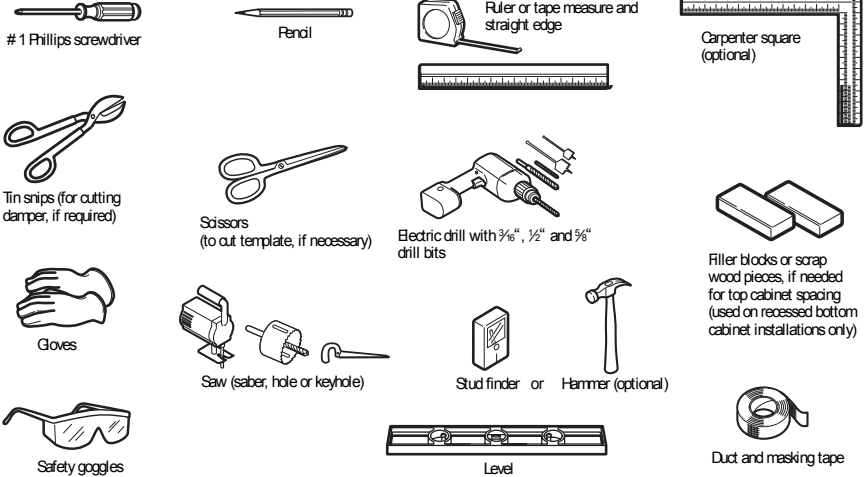

## MOUNTING SPACE

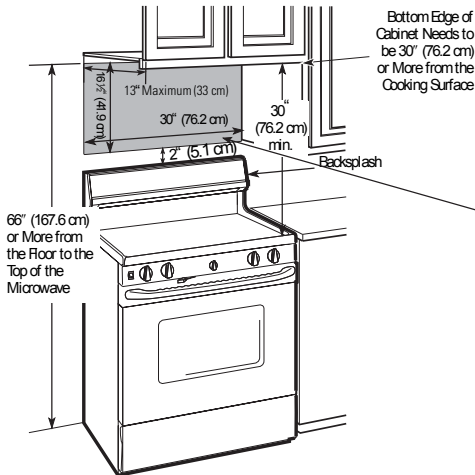

### NOTES

- The space between the cabinets must be 30" (76.2 cm) wide and free of obstructions
- If you are going to vent your microwave oven to the outside, see Hood Exhaust Section for exhaust duct preparation.
- When installing the microwave oven beneath smooth, flat cabinets, be careful to follow the instructions on the top cabinet template for power cord clearance.
- As a guide to installation, see page 25 for Mounting Template Information.
- If the cabinet depth including the cabinet doors is more than 13" then the unit must be spaced out from wall using adequate materials supporting 150 lbs to allow proper top vent air exhaust/ intake.

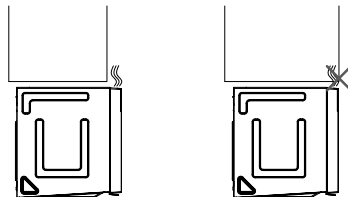

# USERS MANUAL

# INSTALLATION

## 1 PLACEMENT OF THE MOUNTING PLATE

### A. REMOVING THE MICROWAVE OVEN FROM THE CARTON/ REMOVING THE MOUNTING PLATE

- 1 Remove the top cover board, installation instructions, use and care, exhaust adapter, turntable ring, shelf, filters, glass tray and the small hardware bag. Do not remove the Styrofoam protecting the front of the oven.

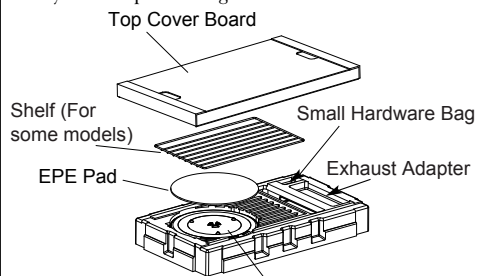

- 2 Fold back all 4 carton flaps fully against carton sides. Then carefully roll the oven and carton over onto the top side. The oven should be resting in the Styrofoam.

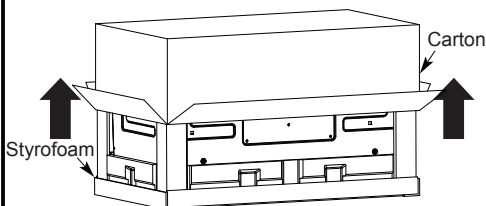

- 3 Pull the carton up and off the oven.

- 4 Cut the middle of the outer protective plastic bag to remove the mounting plate

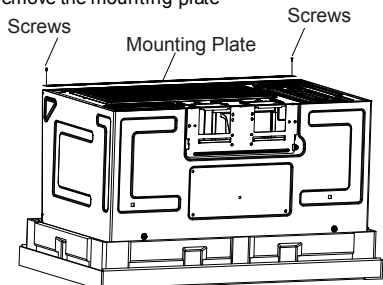

- 5 Remove the screws from each end of the mounting plate. This plate will be used as the rear wall template and for mounting. Reinstall the screws into the holes where they were removed.

### B. FINDING THE WALL STUDS

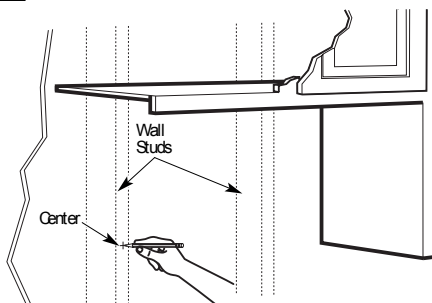

- 1 Find the studs, using one of the following methods:
- A. Stud finder – a magnetic device which locates nails.
  - B. Use a hammer to tap lightly across the mounting surface to find a solid sound. This will indicate a stud location.
- 2 After locating the stud(s), find the center by probing the wall with a small nail to find the edges of the stud. Then place a mark halfway between the edges. The center of any adjacent studs should be 16" (40.6 cm) or 24" (61 cm) from this mark.
- 3 Draw a line down the center of the studs.

**THE MICROWAVE MUST BE CONNECTED TO AT LEAST ONE WALL STUD.**

# INSTALLATION

## C. DETERMINING WALL PLATE LOCATION UNDER YOUR CABINET

Plate position-beneath flat bottom cabinet

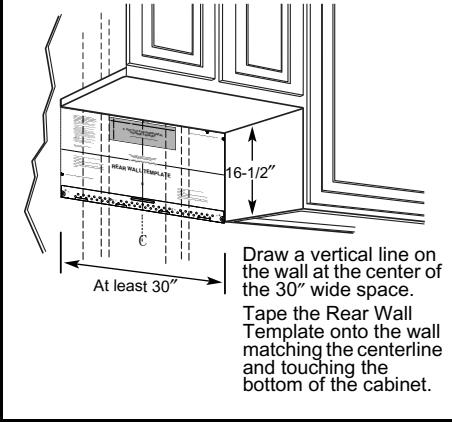

Plate position-beneath framed recessed cabinet bottom

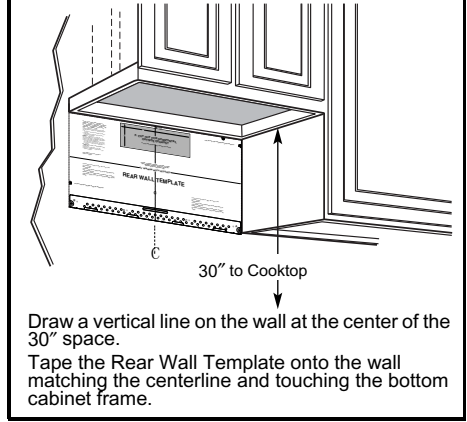
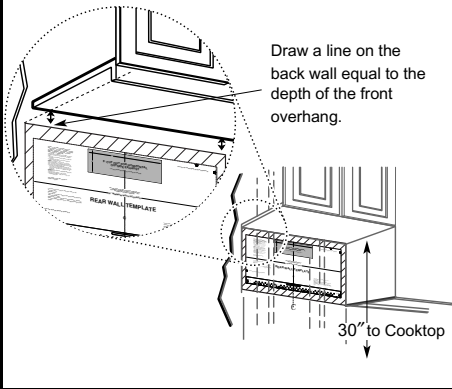

Plate position-beneath recessed bottom cabinet with front overhang



Your cabinets may have decorative trim that interferes with the microwave installation. Remove the decorative trim to install the microwave properly and to make it level.

### THE MICROWAVE MUST BE LEVEL.

Use a level to make sure the cabinet bottom is level.

If the cabinets have a front overhang only, with no back or side frame, install the mounting plate down the same distance as the front overhang depth. This will keep the microwave level.

- 1 Measure the inside depth of the front overhang.
- 2 Draw a horizontal line on the back wall an equal distance below the cabinet bottom as the inside depth of the front overhang.
- 3 For this type of installation with front overhang only, align the mounting tabs with this horizontal line, not touching the cabinet bottom as described in Step D.

# INSTALLATION

## D. ALIGNING THE WALL PLATE

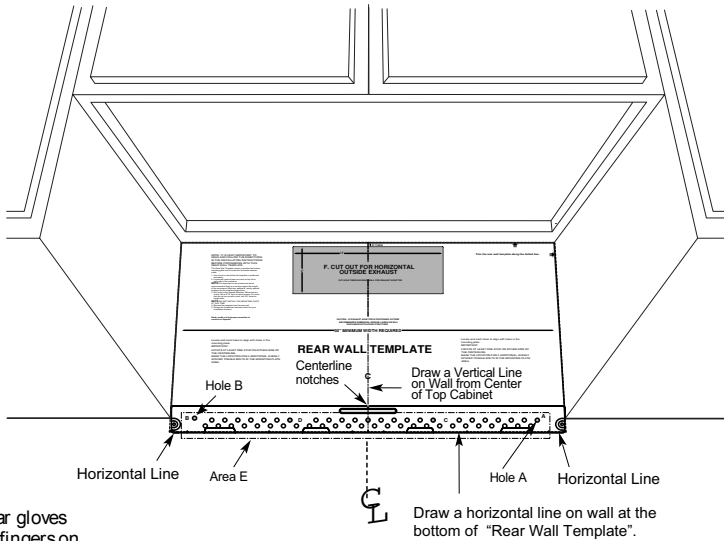

**CAUTION:** Wear gloves to avoid cutting fingers on sharp edges.

- 1 Draw a vertical line on the wall at the center of the 30" wide space.
- 2 Draw a horizontal line on the wall at the bottom of "Rear Wall Template".
- 3 Find a wall stud in area "E" of mounting plate. Refer to section 1B. Finding the wall studs.
- 4 For attaching the mounting plate into stud drill a 3/16" hole into wood stud. Drill a 5/8" hole for toggle bolt in 1 other location (Hole A or Hole B)  
NOTE: DO NOT MOUNT THE PLATE AT THIS TIME.

**NOTE:** Holes A and B are inside area E. If neither of Holes A and B are not in a stud, find a stud somewhere in area E and draw a circle to line up with the stud. It is important to have **at least one wood screw** mounted **firmly in a stud** to support the weight of the microwave. **Set the mounting plate aside.**

# INSTALLATION

## 2 INSTALLATION TYPES (Choose A, B or C)

This microwave oven is designed for adaptation to the following three types of ventilation:

- A. Outside Top Exhaust (Vertical Duct)
- B. Outside Back Exhaust (Horizontal Duct)
- C. Recirculating (Non-Vented Ductless)

**NOTE:** This microwave is shipped assembled for Recirculating. Select the type of ventilation required for your installation and proceed to that section.

### A OUTSIDE TOP EXHAUST (VERTICAL DUCT)

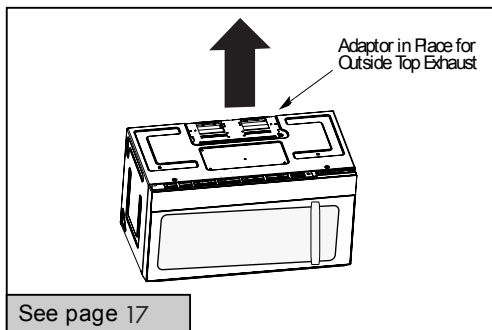

### B OUTSIDE BACK EXHAUST (HORIZONTAL DUCT)

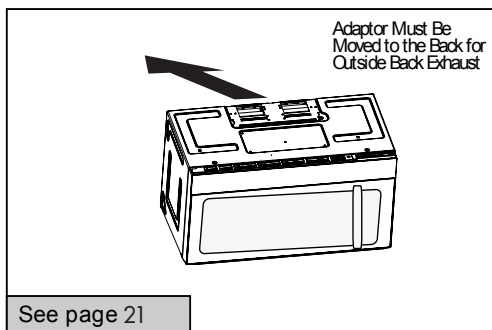

### C RECIRCULATING (NON-VENTED DUCTLESS)

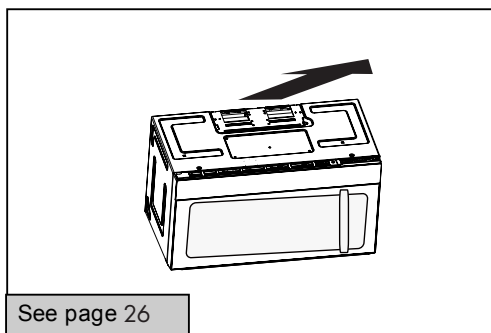

Models are shipped for recirculating exhaust. Some models have a disposable charcoal filter installed to help remove smoke and odors.

**NOTE:** Read the next two pages only if you plan to vent your exhaust to the outside. If you plan to recirculate the air back into the room, proceed to page 20.



# INSTALLATION

## INSTALLATION INSTRUCTIONS FOR EXTERNAL EXHAUST DUCTING

**NOTE:** If you need to install ducts, note that the total duct length of 3/4" x 10" (8.2 x 25.4 cm) rectangular or 5" (12.7 cm) diameter/ 6" (15.2 cm) diameter round duct should not exceed 120 equivalent feet (36.5 m).

Outside ventilation requires an **EXTERNAL EXHAUST DUCT**. Read the following carefully.

**NOTE:** It is important that venting be installed using the most direct route and with as few elbows as possible. This ensures clear venting of exhaust and helps prevent blockages. Also, make sure dampers swing freely and nothing is blocking the ducts.

### Exhaust connection:







The exhaust adaptor has been designed to mate with a standard 3/4" x 10" (8.2 x 25.4 cm) rectangular duct.

If a round duct is required, a rectangular-to-round transition adaptor must be used. A 5" (12.7cm)/ 6" (15.2cm) diameter duct is acceptable to use.

### Maximum duct length:

For satisfactory air movement, the total duct length of 3/4" x 10" (8.2 x 25.4 cm) rectangular or 5" (12.7 cm) diameter/ 6" (15.2 cm) diameter round duct should not exceed 120 equivalent feet (36.5 m).

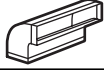
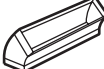
Elbows, transitions, wall and roof caps, etc., present additional resistance to airflow and are equivalent to a section of straight duct which is longer than their actual physical size. When calculating the total duct length, add the equivalent lengths of all transitions and adaptors plus the length of all straight duct sections. The chart below shows you how to calculate total equivalent ductwork length using the approximate feet of equivalent length of some typical ducts.

DUCT PIECES		EQUIVALENT LENGTH	x	NUMBER USED	=	EQUIVALENT LENGTH
	Rectangular-to-Round Transition Adaptor*	5 Ft. (1.5 m)	x	( )	=	Ft. or m
	Wall Cap	40 Ft. (12.2 m)	x	( )	=	Ft. or m
	90° Elbow	10 Ft. (3 m)	x	( )	=	Ft. or m
	45° Elbow	5 Ft. (1.5 m)	x	( )	=	Ft. or m
	90° Elbow	25 Ft. (7.6 m)	x	( )	=	Ft. or m
	45° Elbow	5 Ft. (1.5 m)	x	( )	=	Ft. or m
	Roof Cap	24 Ft. (7.3 m)	x	( )	=	Ft. or m
	Straight Duct 6" (15.2 cm) Round or 3/4" x 10" (8.2 x 25.4 cm Rectangular)	1 Ft. (0.3 m)	x	( )	=	Ft. or m
Total Ductwork					=	Ft. or m



\* **IMPORTANT:** If a rectangular-to-round transition adaptor is used, the bottom corners of the damper will have to be cut to fit, using the tin snips, in order to allow free movement of the damper.

Equivalent lengths of duct pieces are based on actual tests and reflect requirements for good venting performance with any vent hood.



# INSTALLATION

## EXTERNAL EXHAUST DUCTING

### OUTSIDE TOP EXHAUST (EXAMPLE ONLY)

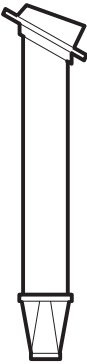
The following chart describes an example of one possible ductwork installation.







DUCT PIECES		EQUIVALENT LENGTH	x	NUMBER USED	=	EQUIVALENT LENGTH
	Roof Cap	24 Ft. (7.3 m)	x	(1)	=	24 Ft. (7.3 m)
	12 Ft. (3.6 m) Straight Duct (6"/15.2 cm Round)	12 Ft. (3.6 m)	x	(1)	=	12 Ft. (3.6 m)
	Rectangular-to-Round Transition Adaptor*	5 Ft. (1.5 m)	x	(1)	=	5 Ft. (1.5 m)
Equivalent lengths of duct pieces are based on actual tests and reflect requirements for good venting performance with any vent hood.					Total Length =	41 Ft. (12.4 m)

\* IMPORTANT: If a rectangular-to-round transition adaptor is used, the bottom corners of the damper will have to be cut to fit, using the tin snips, in order to allow free movement of the damper.

### OUTSIDE BACK EXHAUST (EXAMPLE ONLY)

The following chart describes an example of one possible ductwork installation.



DUCT PIECES		EQUIVALENT LENGTH*	x	NUMBER USED	=	EQUIVALENT LENGTH
	Wall Cap	40 Ft. (12.2 m)	x	(1)	=	40 Ft. (12.2 m)
	3 Ft. Straight Duct (3/4" x 10"/8.2 x 25.4 cm Rectangular)	3 Ft. (0.9 m)	x	(1)	=	3 Ft. (0.9 m)
	90° Elbow	10 Ft. (3 m)	x	(2)	=	20 Ft. (6 m)
Equivalent lengths of duct pieces are based on actual tests and reflect requirements for good venting performance with any vent hood.					Total Length =	63 Ft. (19.1 m)

NOTE: For back exhaust, care should be taken to align exhaust with space between studs, or wall should be prepared at the time it is constructed by leaving enough space between the wall studs to accommodate exhaust.

# INSTALLATION

## A OUTSIDE TOP EXHAUST (Vertical Duct)

### INSTALLATION OVERVIEW

- A1. Attach Mounting Plate to Wall
- A2. Prepare Top Cabinet
- A3. Adapting Microwave Blower for Outside Top Exhaust
- A4. Check Damper Operation
- A5. Mount Microwave Oven
- A6. Adjust Exhaust Adaptor
- A7. Connect Ductwork

#### IMPORTANT NOTES:

- Make sure the screws for the blower motor and blower plate are securely tightened when they are reinstalled. This will help to prevent excessive vibration.
- Make sure the motor wiring has been properly routed and secured, and that the wires are not pinched.

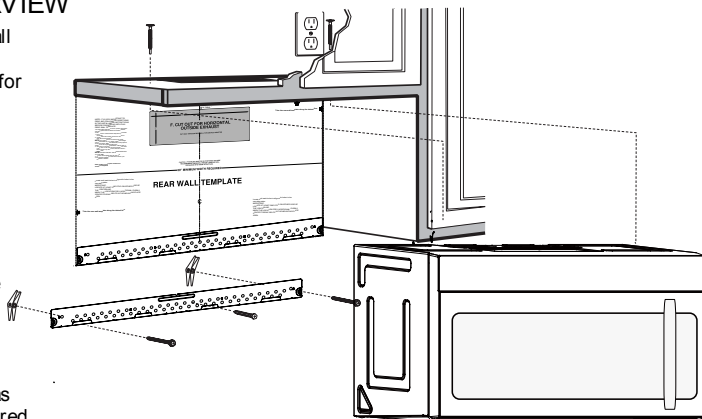

### A1. ATTACH THE MOUNTING PLATE TO THE WALL

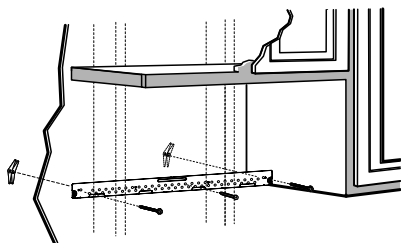

Attach the plate to the wall using toggle bolts. At least one wood screw must be used to attach the plate to a wall stud.

- 1 Remove the toggle wings from the bolts.
- 2 Insert the bolts into the mounting plate through the holes designated to go into drywall and reattach the toggle wings to  $\frac{3}{4}$ " (19 mm) onto each bolt.

#### To use toggle bolts:

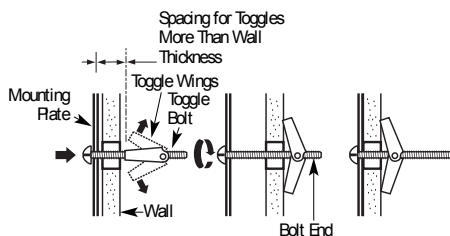

- 3 Place the mounting plate against the wall and insert the toggle wings into the holes in the wall to mount the plate.

NOTE: Before tightening toggle bolts and wood screw, make sure the bottom of the mounting plate touch the bottom of the cabinet when pushed flush against the wall and that the plate is properly centered under the cabinet.

CAUTION: Be careful to avoid pinching fingers between the back of the mounting plate and the wall.

- 4 Tighten all bolts. Pull the plate away from the wall to help tighten the bolts.

# INSTALLATION

## A2. USE TOP CABINET TEMPLATE FOR PREPARATION OF TOP CABINET

You need to drill holes for the top support screws, a hole large enough for the power cord to fit through, and a cutout large enough for the exhaust adaptor.

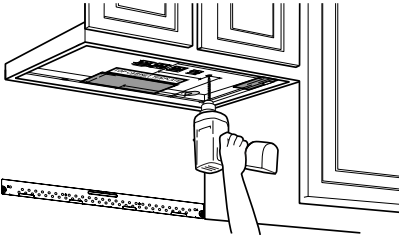

- Read the instructions on the TOP CABINET TEMPLATE.
- Tape it underneath the top cabinet.
- Drill the holes, following the instructions on the TOP CABINET TEMPLATE.

**CAUTION:** Wear safety goggles when drilling holes in the cabinet bottom.

## A3. ADAPTING MICROWAVE BLOWER FOR OUTSIDE TOP EXHAUST

- 1 Place the microwave in its upright position, with the top of the unit facing up.

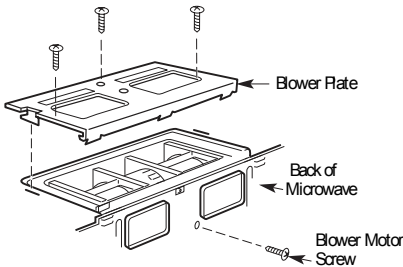

Remove the screw that holds the blower plate to the microwave. Remove and save the screw holding the blower motor to the microwave.

- 2 Carefully pull out the blower unit. The wires will extend far enough to allow you to adjust the blower unit.

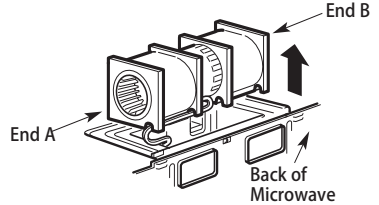

- 3 Roll the blower unit 90° so that fan blade openings are facing out the top of the microwave.

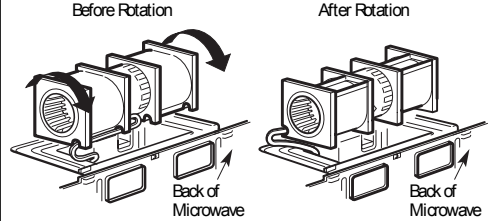

- 4 Place the blower unit back into the opening.

**AFTER:** Fan Blade Openings Facing Top

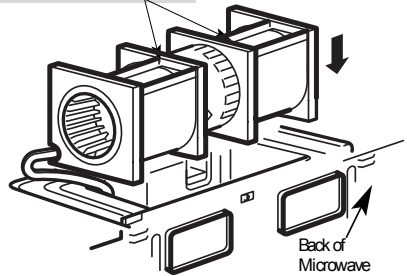

**CAUTION:** Do not pull or stretch the blower unit wiring. Make sure the wires are not pinched, and that they are properly secured.

# INSTALLATION

## A3. ADAPTING MICROWAVE BLOWER FOR OUTSIDE TOP EXHAUST

- Secure blower unit to microwave with the screw removed in Step 1. Make sure the screw is tight.
- Replace blower plate with the screw removed in Step 1. Make sure the screw is tight.

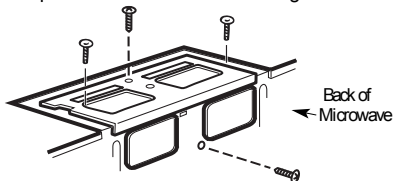

- Attach the exhaust adaptor to the top of the blower plate by sliding it into the guides of the blower plate.

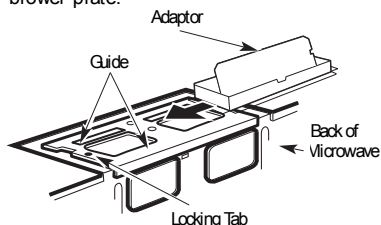

Push in securely until it is in the locking tabs. Take care to assure that the damper hinge is installed so that the damper swings freely.

## A4. CHECK FOR PROPER DAMPER OPERATION

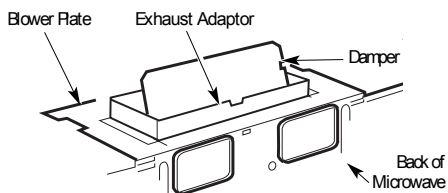

- Make sure tape securing damper is removed and damper pivots easily before mounting microwave.
- You will need to make adjustments to assure proper alignment with your house exhaust duct after the microwave is installed.

## A5. MOUNT THE MICROWAVE OVEN

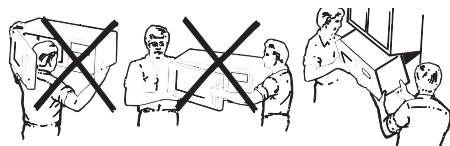

FOR EASIER INSTALLATION AND PERSONAL SAFETY, WE RECOMMEND THAT TWO PEOPLE INSTALL THIS MICROWAVE OVEN.

**IMPORTANT:** Do not grip or use the handle or heat shield during installation. Do not remove the cardboard spacers between the heat shield and door.

**NOTE:** If your cabinet is metal, use the nylon grommet around the power cord hole to prevent cutting of the cord.

**NOTE:** We recommend using filler blocks if the cabinet front hangs below the cabinet bottom shelf.

**IMPORTANT:** If filler blocks are not used, case damage may occur from overtightening screws.

**NOTE:** When mounting the microwave oven, thread power cord through hole in bottom of top cabinet. Keep it tight throughout Steps 1-3. Do not pinch cord or lift oven by pulling cord.

- Lift microwave, tilt it forward, and hook slots at back bottom edge onto four lower tabs of mounting plate.

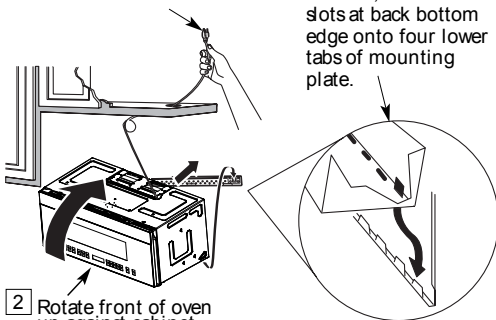

- Rotate front of oven up against cabinet bottom.
- Insert a self-aligning screw through top center cabinet hole. Temporarily secure the oven by turning the screw at least two full turns after the threads have engaged. (It will be completely tightened later.) Be sure to keep power cord tight. Be careful not to pinch the cord, especially when mounting flush to bottom of cabinet.

# INSTALLATION

## A5. MOUNT THE MICROWAVE OVEN (cont.)

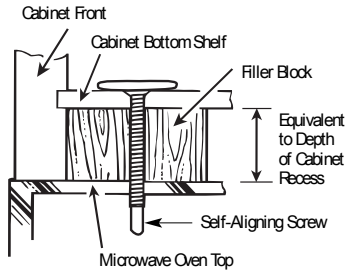

4 Attach the microwave oven to the top cabinet.

5 Insert 2 self-aligning screws through outer top cabinet holes. Turn two full turns on each screw.

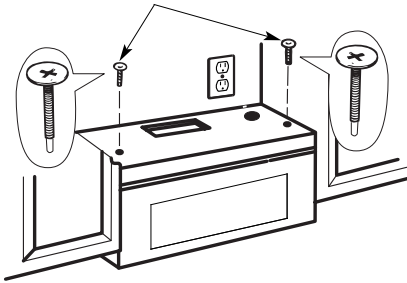

7 Tighten the outer two screws to the top of the microwave oven. (While tightening screws, hold the microwave oven in place against the wall and the top cabinet.)

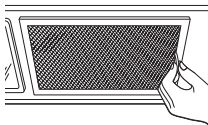

8 Install grease filters. See the Use & Care packed with the microwave.

## A6. ADJUST THE EXHAUST ADAPTOR

Open the top cabinet and adjust the exhaust adaptor to connect to the house duct.

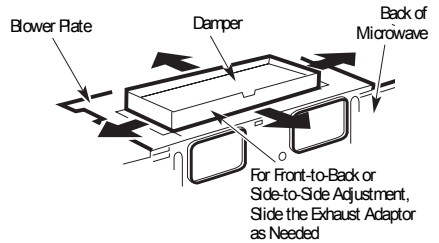

## A7. CONNECTING DUCTWORK

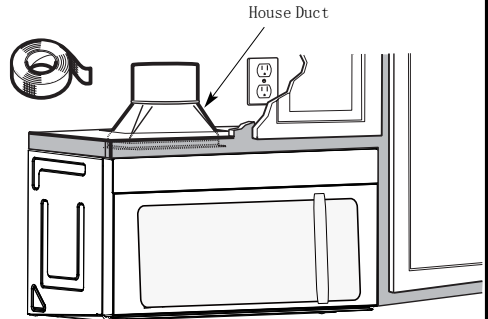

- 1 Extend the house duct down to connect to the exhaust adaptor.
- 2 Seal exhaust duct joints using furnace duct tape for high temperature applications.

# INSTALLATION

## B OUTSIDE BACK EXHAUST (Horizontal Duct)

### INSTALLATION OVERVIEW

- B1. Prepare Rear Wall
- B2. Remove Blower Plate
- B3. Attach Mounting Plate to Wall
- B4. Prepare Top Cabinet
- B5. Adjust Blower
- B6. Mount the Microwave Oven

#### IMPORTANT NOTES:

- Make sure the screws for the blower motor and blower plate are securely tightened when they are reinstalled. This will help to prevent excessive vibration.
- Make sure the motor wiring has been properly routed and secured, and that the wires are not pinched.

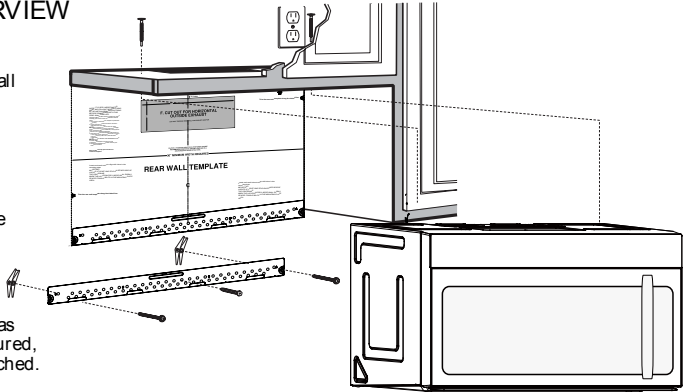

### B1. PREPARING THE REAR WALL FOR OUTSIDE BACK EXHAUST

You need to cut an opening in the rear wall for outside exhaust.

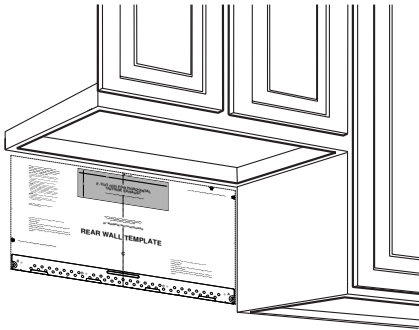

- Read the instructions on the REAR WALL TEMPLATE.
- Tape it to the rear wall.
- Cut the opening, following the instructions of the REAR WALL TEMPLATE.

### B2. REMOVE BLOWER PLATE

Remove and save the screw that holds the blower plate to the microwave. Lift off the blower plate.

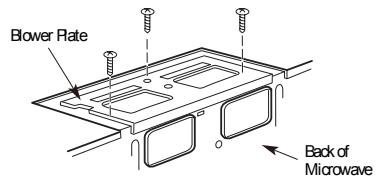

# INSTALLATION

## B OUTSIDE BACK EXHAUST (Horizontal Duct)

### INSTALLATION OVERVIEW

- B1. Prepare Rear Wall
- B2. Remove Blower Plate
- B3. Attach Mounting Plate to Wall
- B4. Prepare Top Cabinet
- B5. Adjust Blower
- B6. Mount the Microwave Oven

#### IMPORTANT NOTES:

- Make sure the screws for the blower motor and blower plate are securely tightened when they are reinstalled. This will help to prevent excessive vibration.
- Make sure the motor wiring has been properly routed and secured, and that the wires are not pinched.

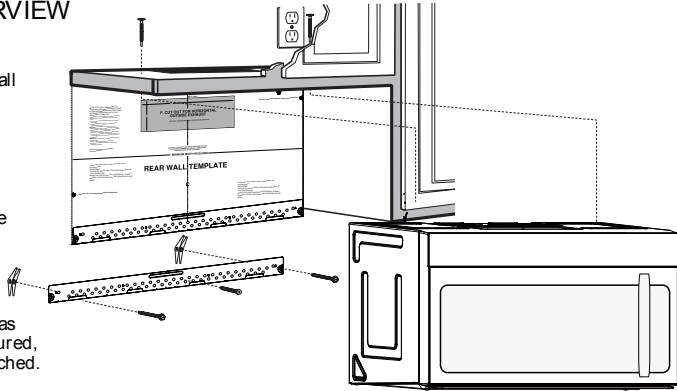

### B1. PREPARING THE REAR WALL FOR OUTSIDE BACK EXHAUST

You need to cut an opening in the rear wall for outside exhaust.

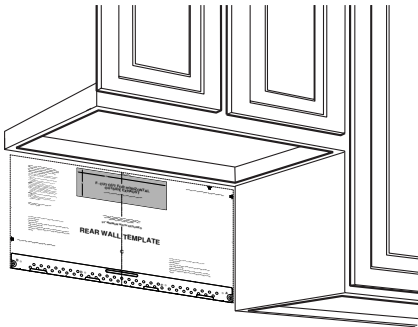

- Read the instructions on the REAR WALL TEMPLATE.
- Tape it to the rear wall.
- Cut the opening, following the instructions of the REAR WALL TEMPLATE.

### B2. REMOVE BLOWER PLATE

Remove and save the screw that holds the blower plate to the microwave. Lift off the blower plate.

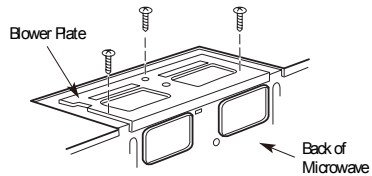



# INSTALLATION

## B3. ATTACH THE MOUNTING PLATE TO THE WALL

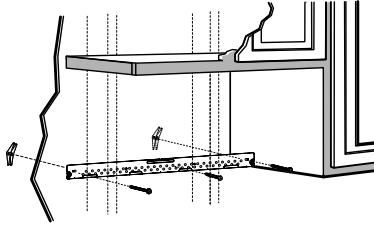

Attach the plate to the wall using toggle bolts. At least one wood screw must be used to attach the plate to a wall stud.

- 1 Remove the toggle wings from the bolts.
- 2 Insert the bolts into the mounting plate through the holes designated to go into drywall and reattach the toggle wings to  $\frac{3}{4}$ " (19 mm) onto each bolt.

To use toggle bolts:

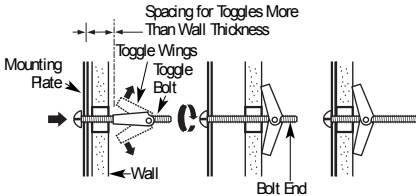

- 3 Place the mounting plate against the wall and insert the toggle wings into the holes in the wall to mount the plate.

NOTE: Before tightening toggle bolts and wood screw, make sure the bottom of the mounting plate touch the bottom of the cabinet when pushed flush against the wall and that the plate is properly centered under the cabinet.

CAUTION: Be careful to avoid pinching fingers between the back of the mounting plate and the wall.

- 4 Tighten all bolts. Pull the plate away from the wall to help tighten the bolts.

## B4. USE TOP CABINET TEMPLATE FOR PREPARATION OF TOP CABINET

You need to drill holes for the top support screws and a hole large enough for the power cord to fit through.

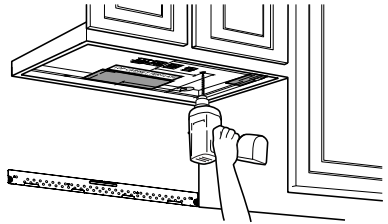

- Read the instructions on the TOP CABINET TEMPLATE.
- Tape it underneath the top cabinet.
- Drill the holes, following the instructions on the TOP CABINET TEMPLATE.

CAUTION: Wear safety goggles when drilling holes in the cabinet bottom.

## B5. ADAPTING MICROWAVE BLOWER FOR OUTSIDE BACK EXHAUST

- 1 Remove and save screw that holds blower motor to microwave.

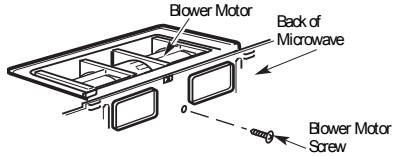

- 2 Carefully pull out the blower unit. The wires will extend far enough to allow you to adjust the blower unit.

Before: Fan Blade Openings Facing Forward

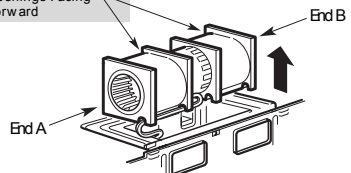

- 3 Roll the blower unit 90°

Before Rotation

After Rotation

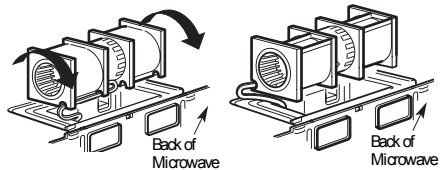

# INSTALLATION

## B5. ADAPTING MICROWAVE BLOWER FOR OUTSIDE BACK EXHAUST (cont.)

- 4 Rotate blower unit counterclockwise 180°.

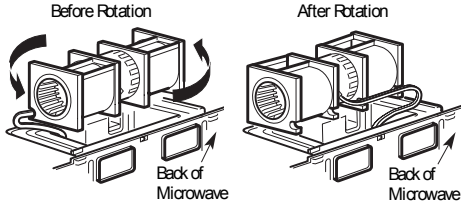

- 5 Gently remove the wires from the grooves. Reroute the wires through grooves on other side of the blower unit.

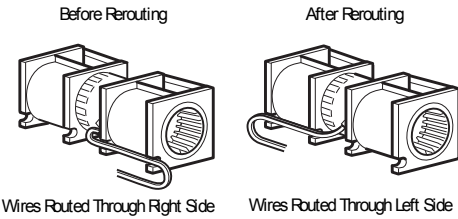

- 6 Roll the blower unit 90° so that fan blade openings are facing out the back of the microwave.

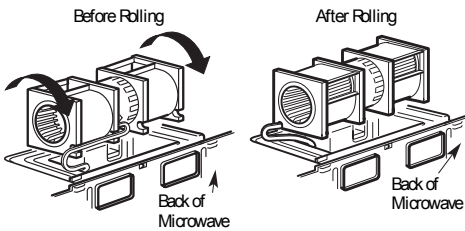

- 7 Remove the knockout plates in the back of the unit with snips. (For some models)

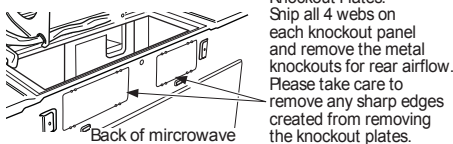

- 8 Place the blower unit back into the opening.

AFTER: Fan Blade Openings Facing Back

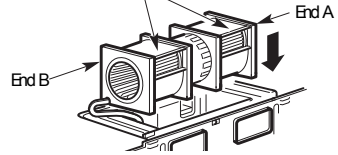

CAUTION: Do not pull or stretch the blower unit wiring. Make sure the wires are not pinched, and that they are properly secured.

NOTE: The blower unit exhaust openings should match exhaust openings on rear of microwave oven.

- 9 Secure the blower unit to the microwave with the original screw.

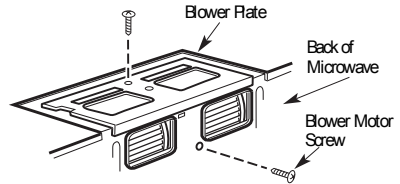

- 10 Replace the blower plate in the same position as before with the screw. Make sure the screw is tight.

- 11 Attach the exhaust adaptor to the rear of the oven by sliding it into the guides at the top center of the back of the oven.

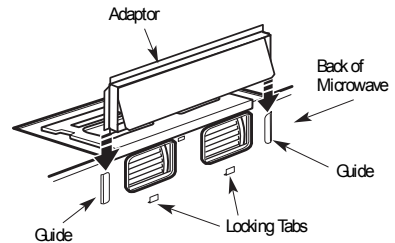

Push in securely until it is in the lower locking tabs. Take care to assure that the damper hinge is installed so that it is at the top and that the damper swings freely.

# INSTALLATION

## B6. MOUNT THE MICROWAVE OVEN

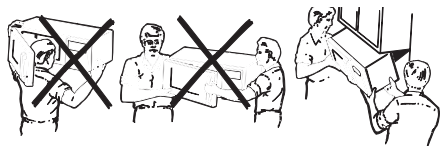

FOR EASIER INSTALLATION AND PERSONAL SAFETY, WE RECOMMEND THAT TWO PEOPLE INSTALL THIS MICROWAVE OVEN.

**IMPORTANT:** Do not grip or use the handle or heat shield during installation. Do not remove the cardboard spacers between the heat shield and door.

**NOTE:** If your cabinet is metal, use the nylon grommet around the power cord hole to prevent cutting of the cord.

**NOTE:** We recommend using filler blocks if the cabinet front hangs below the cabinet bottom shelf.

**IMPORTANT:** If filler blocks are not used, case damage may occur from overtightening screws.

**NOTE:** When mounting the microwave oven, thread power cord through hole in bottom of top cabinet. Keep it tight throughout Steps 1-3. Do not pinch cord or lift oven by pulling cord.

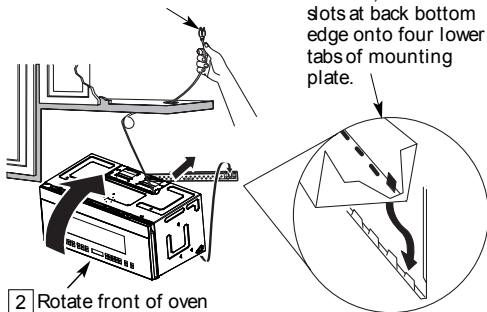

- 1 Lift microwave, tilt it forward, and hook slots at back bottom edge onto four lower tabs of mounting plate.

- 2 Rotate front of oven up against cabinet bottom.

- 3 Insert a self-aligning screw through top center cabinet hole. Temporarily secure the oven by turning the screw at least two full turns after the threads have engaged. (It will be completely tightened later.) Be sure to keep power cord tight. Be careful not to pinch the cord, especially when mounting flush to bottom of cabinet.

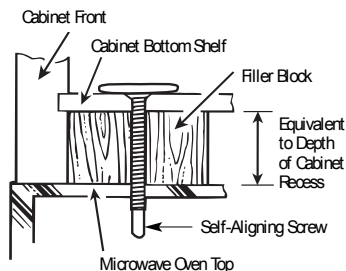

- 4 Attach the microwave oven to the top cabinet.

- 5 Insert 2 self-aligning screws through outer top cabinet holes. Turn two full turns on each screw.

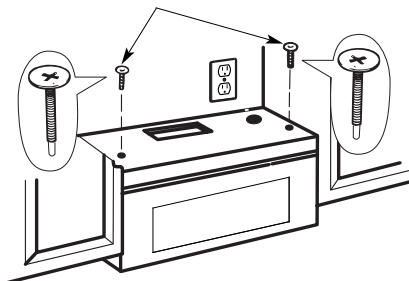

- 7 Tighten the outer two screws to the top of the microwave oven. (While tightening screws, hold the microwave oven in place against the wall and the top cabinet.)

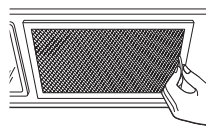

- 8 Install grease filters. See the Use and Care packed with the microwave.

# INSTALLATION

## C RECIRCULATING (Non-Vented Ductless)

### INSTALLATION OVERVIEW

- C1. Attach Mounting Plate to Wall
- C2. Prepare Top Cabinet
- C3. Check Blower Plate
- C4. Mount the Microwave Oven
- C5. Install or change Charcoal Filter

#### IMPORTANT NOTES:

- Make sure the screws for the blower motor and blower plate are securely tightened when they are reinstalled. This will help to prevent excessive vibration.
- Make sure the motor wiring has been properly routed and secured, and that the wires are not pinched.

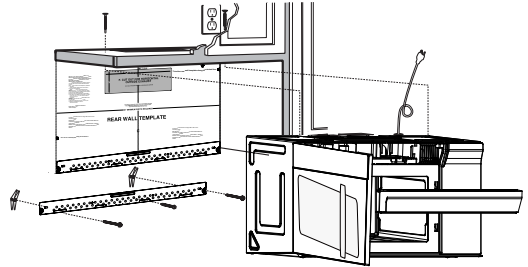

### C1. ATTACH THE MOUNTING PLATE TO THE WALL

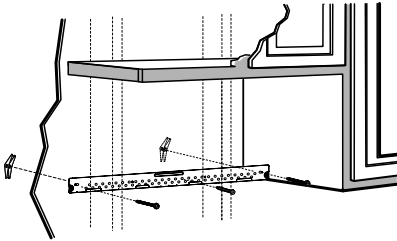

Attach the plate to the wall using toggle bolts. At least one wood screw must be used to attach the plate to a wall stud.

**NOTE:** If the cabinet depth including the cabinet doors is more than 13" then the unit must be spaced out from wall using adequate materials supporting 150 lbs to allow proper top vent air exhaust/ intake.

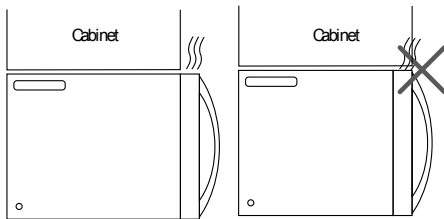

- 1 Remove the toggle wings from the bolts.
- 2 Insert the bolts into the mounting plate through the holes designated to go into drywall and reattach the toggle wings to  $\frac{3}{4}$ " (19 mm) onto each bolt.

To use toggle bolts:

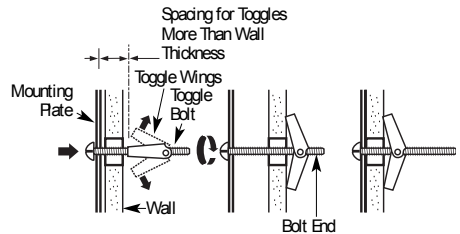

- 3 Place the mounting plate against the wall and insert the toggle wings into the holes in the wall to mount the plate.

**NOTE:** Before tightening toggle bolts and wood screw, make sure the bottom of the mounting plate touch the bottom of the cabinet when pushed flush against the wall and that the plate is properly centered under the cabinet.

**CAUTION:** Be careful to avoid pinching fingers between the back of the mounting plate and the wall.

- 4 Tighten all bolts. Pull the plate away from the wall to help tighten the bolts.

# INSTALLATION

## C2. USE TOP CABINET TEMPLATE FOR PREPARATION OF TOP CABINET

You need to drill holes for the top support screws and a hole large enough for the power cord to fit through.

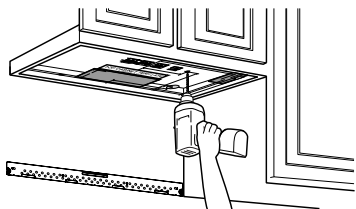

- Read the instructions on the TOP CABINET TEMPLATE.
- Tape it underneath the top cabinet.

**NOTE:** Adjust top template accordingly if the microwave is being spaced out from the wall due to cabinet depth (including cabinet doors) of more than 13".

- Drill the holes, following the instructions on the TOP CABINET TEMPLATE.

**CAUTION:** Wear safety goggles when drilling holes in the cabinet bottom.

## C3. CHECK BLOWER PLATE

Blower Plate

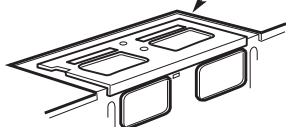

- Place the microwave in its upright position, with the top of the unit facing up.
- Check to see that the blower plate is correctly installed on the unit.

## C4. MOUNT THE MICROWAVE OVEN



FOR EASIER INSTALLATION AND PERSONAL SAFETY, WE RECOMMEND THAT TWO PEOPLE INSTALL THIS MICROWAVE OVEN.

**IMPORTANT:** Do not grip or use the handle or heat shield during installation. Do not remove the cardboard spacers between the heat shield and door.

**NOTE:** If your cabinet is metal, use the nylon grommet around the power cord hole to prevent cutting of the cord.

**NOTE:** We recommend using filler blocks if the cabinet front hangs below the cabinet bottom shelf.

**IMPORTANT:** If filler blocks are not used, case damage may occur from overtightening screws.

**NOTE:** When mounting the microwave oven, thread power cord through hole in bottom of top cabinet. Keep it tight throughout Steps 1-3. Do not pinch cord or lift oven by pulling cord.

- 1 Lift microwave, tilt it forward, and hook slots at back bottom edge onto four lower tabs of mounting plate.

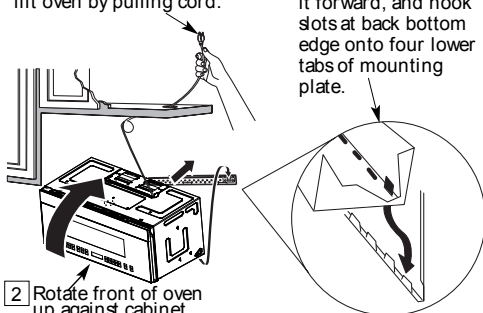

- 2 Rotate front of oven up against cabinet bottom.
- 3 Insert a self-aligning screw through top center cabinet hole. Temporarily secure the oven by turning the screw at least two full turns after the threads have engaged. (It will be completely tightened later.) Be sure to keep power cord tight. Be careful not to pinch the cord, especially when mounting flush to bottom of cabinet.

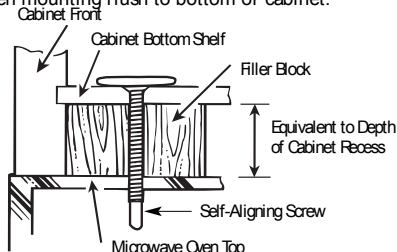

- 4 Attach the microwave oven to the top cabinet.

# INSTALLATION

## C4. MOUNT THE MICROWAVE OVEN (cont.)

- 5 Insert 2 self-aligning screws through outer top cabinet holes. Turn two full turns on each screw.

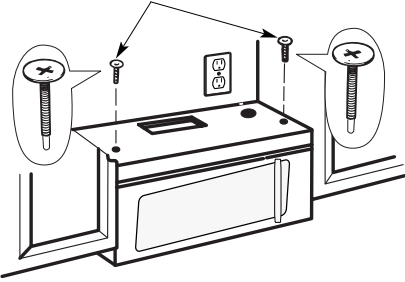

- 7 Tighten the outer two screws to the top of the microwave oven. (While tightening screws, hold the microwave oven in place against the wall and the top cabinet.)

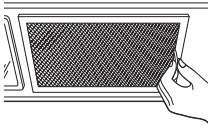

- 8 Install grease filters. See the Use and Care packed with the microwave.

## C5. INSTALLING OR CHANGE THE CHARCOAL FILTER (Some Models)

NOTE: The charcoal filter is factory installed in some models. Refer to the Use and Care to see if yours is factory installed and for replacement information.

For models without the recirculation filter access door, follow these steps to replace or install a charcoal filter.

- 1 Unplug microwave oven or disconnect power.

- 2 Open the microwave door and remove the two vent mounting screws located on top of the microwave using a #1 Phillips screwdriver.

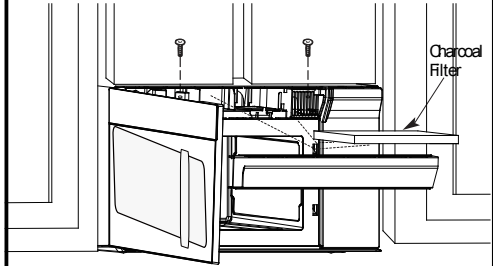

- 3 Remove the charcoal filter by pushing the top of the filter inwards, then pull it forward out of the unit.

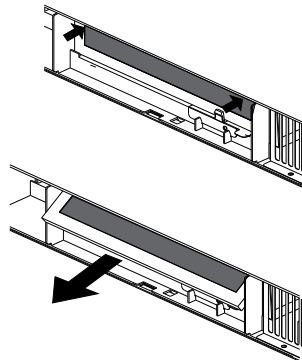

- 4 Slide the top of the new charcoal filter into the top of the filter cavity.

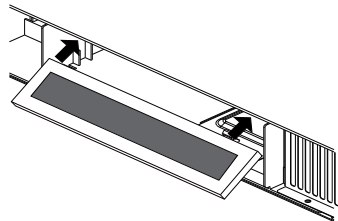

# INSTALLATION

- 5 Press the bottom of charcoal filter to place it into the correct position.

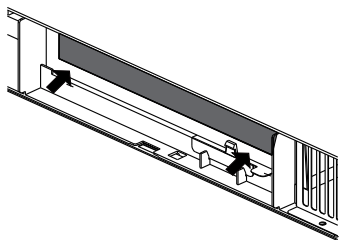

- 6 Reinstall the vent by sliding the bottom of the vent into place. Push the vent top into position and slide right into place. Replace the two vent mounting screws located on top of the microwave using a #1 Phillips screwdriver.

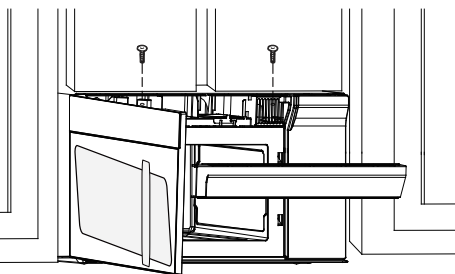

- 7 Close the microwave door. Plug in microwave oven or reconnect power.

# INSTALLATION

## BEFORE YOU USE YOUR MICROWAVE

1. Make sure the microwave oven has been installed according to instructions.



2. Remove all packing material from the microwave oven.

3. Install turntable ring and glass tray in cavity.

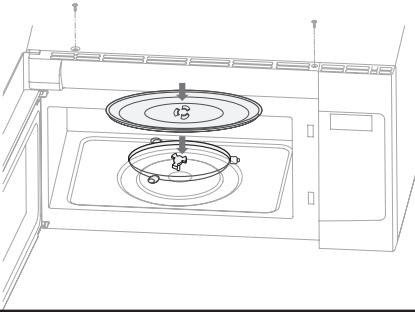

4. Plug power cord into a separate and dedicated 15- to 20-amp electrical outlet.

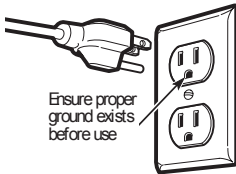

5. Replace house fuse or turn breaker back on.

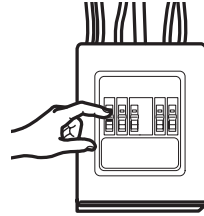

6. Read the USE & CARE Manual.



7. KEEP INSTALLATION INSTRUCTIONS FOR THE LOCAL INSPECTOR'S USE.



8. FILL OUT PRODUCT REGISTRATION CARD AND SEND IN.





## RADIO INTERFERENCE

- Operation of the microwave oven may cause interference to your radio, TV, or similar equipment.
- When there is interference, it may be reduced or eliminated by taking the following measures:
  - Clean door and sealing surface of the oven.
  - Reorient the receiving antenna of radio or television.
  - Relocate the microwave oven with respect to the receiver.
  - Move the microwave oven away from the receiver.
  - Plug the microwave oven into a different outlet so that microwave oven and receiver are on different branch circuits.

## UTENSILS



**CAUTION:**  
Personal Injury Hazard

- Tightly-closed utensils could explode. Closed containers should be opened and plastic pouches should be pierced before cooking.
- There may be certain non-metallic utensils that are not safe to use for microwaving. If in doubt, you can test the utensil in question by following the procedure below.

Utensil Test:

- Fill a microwave-safe container with 1 cup of cold water (250ml) along with the utensil in question.
- Cook on maximum power for 1 minute.
- Carefully feel the utensil. If the empty utensil is warm, do not use it for microwave cooking.
- Do not exceed 1 minute cooking time.

## MATERIALS YOU CAN USE IN MICROWAVE

### Materials you can use in microwave oven

Utensils	Remarks
Browning dish	Follow manufacturer* instructions. The bottom of browning dish must be at least 3/16 inch (5mm) above the turntable. Incorrect usage may cause the turntable to break.
Dinnerware	Microwave-safe only. Follow manufacturer's instructions. Do not use cracked or chipped dishes.
Glass jars	Always remove lid. Use only to heat food until just warm. Most glass jars are not heat resistant and may break.
Glassware	Heat-resistant oven glassware only. Make sure there is no metallic trim. Do not use cracked or chipped dishes.
Oven cooking bags	Follow manufacturer* instructions. Do not close with metal tie. Make slits to allow steam to escape.
Paper plates and cups	Use for short-term cooking/warming only. Do not leave oven unattended while cooking.
Paper towels	Use to cover food for reheating and absorbing fat. Use with supervision for a short-term cooking only.

### Materials you can use in microwave oven

Utensils	Remarks
Plastic	Microwave-safe only. Follow the manufacturer* instructions. Should be labeled "Microwave Safe". Some plastic containers soften, as the food inside gets hot. "Boiling bags" and tightly closed plastic bags should be slit, pierced or vented as directed by package.
Plastic wrap	Microwave-safe only. Use to cover food during cooking to retain moisture. Do not allow plastic wrap to touch food.
Thermometers	Microwave-safe only (meat and candy thermometers).
Wax paper	Use as a cover to prevent splattering and retain moisture.

### Materials to be avoided in microwave oven

Utensils	Remarks
Aluminum tray	May cause arcing. Transfer food into microwave-safe dish.
Food carton with metal handle	May cause arcing. Transfer food into microwave-safe dish.
Metal or metal-trimmed utensils	Metal shields the food from microwave energy. Metal trim may cause arcing.
Metal twist ties	May cause arcing and could cause a fire in the oven.
Paper bags	May cause a fire in the oven.
Plastic foam	Plastic foam may melt or contaminate the liquid inside when exposed to high temperature.
Wood	Wood will dry out when used in the microwave oven and may split or crack.

# SETTING UP YOUR OVEN

Remove the oven and all materials from the carton and oven cavity. Your oven comes with the following accessories:

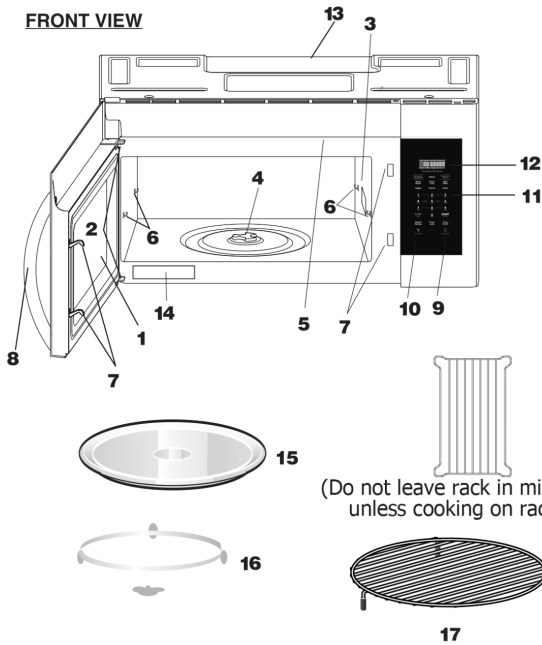

1. Microwave Oven Door
2. Door Hinges
3. Waveguide Cover  
(DO NOT REMOVE)
4. Turntable motor shaft
5. Microwave oven light
6. Rack holders
7. Safety door latches
8. Handle
9. Light Button
10. Vent button
11. Control Panel
12. Display Panel
13. Ventilation
14. Menu label
15. Removable Turntable Plate
16. Removable Turntable Support
17. Rack for 2-level cooking/  
reheating
18. Light cover/Filter Access Door
19. Grease Filters

## BOTTOM VIEW

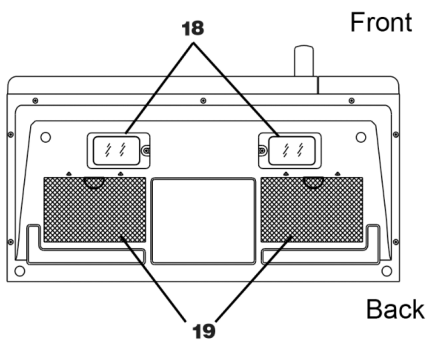

### Using Vent Fan

The pad controls the 2-speed vent fan. If the vent fan is OFF, the first touch of the vent pad will turn the fan from HIGH > LOW > OFF

### Using Cooktop Light

The pad controls the cooktop light. If the light is OFF, the first touch of the light pad will turn the light from HIGH > LOW > OFF



## OPERATION

1. Display - features as a clock and indicator that show time, cooking time settings, cook power, sensor, quantities, weights, and cooking functions
  - 1a. **SENSOR** - when using sensor cook
  - 1b. **TIMER** - when timer is being set or running
  - 1c. **COOK** - starting microwave cooking
  - 1d. **DEFR** - defrosting food
  - 1e. **LOCK** - control lock
  - 1f. **PRESS AGAIN FOR OPTIONS** - additional options are available
  - 1g. **PRESS START** - before a valid function
  - 1h. **KG, OZ, LB** - when choosing weight
  - 1i. **CONVECT** - when choosing convection
  - 1j. **FILTER** - replace filter
2. Convection Bake/Roast
3. Defrost
4. Convection + Micro
5. Sensor Reheat (4 settings)
6. Sensor Cook
7. Melt/Soften
8. Veggies
9. Popcorn
10. Snacks
11. Numerical Pads
12. Stop/Clear
13. Start (+30 seconds)
14. Clock & Settings
15. Power Level (11 power levels)
16. Timer (On-Off)
17. Exhaust (High/Low/Off) - use to turn the exhaust fan off, or to adjust speed
18. Surface Light - press to activate and adjust brightness of lights
19. Quick start (9 instant key settings)

## ONE TOUCH COOKING

### Popcorn:

The microwave oven lets you pop 3.3, 3.0, 1.75 oz bags of commercially packaged microwave popcorn. Pop only one package at a time. If you are using a microwave popcorn popper, follow manufacturer's instructions.

Touch POPCORN.

1. Press again for options
2. Press START

### Vegetables:

The microwave can cook potatoes, frozen vegetables, and fresh vegetables.

1. Touch VEGGIES
2. Press again for options
3. Press START

FOOD	AMOUNT	PROCEDURE
Potato	1-4 pieces	Cooking times are based on an average 8 oz. potato. Pierce with forks in several places. Place on paper towel on turntable. Press the VEGGIES pad one time for potato. After cooking, remove from oven and let stand for 5 minutes
Fresh Vegetables <ul style="list-style-type: none"> <li>• Broccoli</li> <li>• Brussels Sprouts</li> <li>• Cabbage</li> <li>• Cauliflower</li> <li>• Spinach</li> <li>• Zucchini</li>   <li>• Carrots</li> <li>• Corn on cob</li> <li>• Green beans</li> <li>• Winter Squash</li> </ul>	2 cups	Wash and place in casserole. Don't add water if the vegetables have been washed. Cover with lid for tender vegetables. Use plastic wrap for tender-crisp vegetables. Press VEGGIES twice. After cooking, stir. Let stand for 2-5 mins.  Place in casserole. Add 1-4 tbsp. water. Cover with lid for tender vegetables. Use plastic wrap cover for tender crisp vegetables. Press VEGGIES twice for fresh vegetables. After cooking, stir, if possible. Let stand, covered, for 2-5 minutes.
Frozen Vegetables	2 cups	Don't add water if the vegetables have been washed. Press VEGGIES three times. After cooking, stir and let stand, covered, for 3 mins.



## ONE TOUCH COOKING

### **Snack:**

Snack Menu is for cooking/heating foods for a short amount of time.

1. Touch SNACKS
2. Press again to cycle through the menu.
  - CHOCOLATE CHIP COOKIES
  - FROZEN MW PIZZA
  - HOT DOGS
  - FROZEN KID'S MEAL
  - MEAL IN A CUP
  - SOUP
3. Press START
4. Press the numerical pad to choose the portions.
5. Press START

### **Melt/Softens:**

The oven uses lower power to melt and soften items

1. Touch MELT/SOFTEN.
2. Press again to cycle through the menu:
  - BUTTER
  - CHOCOLATE
  - ICE CREAM
  - CREAM CHEESE
3. Press START
4. Press the number keys to set the weight.
5. Press START

### CONVECTION COOKING

There are ten temperatures of convection:

1. 100F
2. 200F
3. 250F
4. 300F
5. 325F
6. 350F
7. 375F
8. 400F
9. 425F
10. 450F

Convection cooking uses a heating element to raise the temperature of the air inside the oven. Any oven temperature from 100F to 450F may be set. A fan gently circulates this heated air throughout the oven, over and around the food.

Because the heated air is kept constantly moving, not permitting a layer of cooler air to develop around the food, some foods cook faster than in regular oven cooking.

**For best results,** always use the round wire rack when convection cooking. Reduce package/recipe temperature 25F for baked goods. The round wire rack is required for good air circulation and even browning.

### USING CONVECTION WITH PREHEATING

1. Press Convection Bake/Roast once (PREHEAT ENTER TEMP)
2. Press the number on the keypad on the desired temperature (see below number. ex: 375F, press 7...)
3. Press START and the oven will PREHEAT
4. Temperature will show on the display, once it's done preheating. Open the door when it's done.
5. Place the food in the oven and press the number keys to set the cooking time.
6. Press START

### USING CONVECTION WITHOUT PREHEATING

1. Press Convection Bake/Roast twice (BAKE ROAST ENTER TEMP)
2. Press the number on the keypad on the desired temperature (see below number. ex: 375F, press 7...)
3. Press START
4. Place the food in the oven and press the number keys to set the cooking time.
5. Press START

### MICROWAVE + CONVECTION COMBINATION

1. Press Convection + Micro (BAKE 325 °F)
2. Press START
3. Place the food in the oven and press the number keys to set the cooking time.
4. Press START

### COOKWARE TIPS

- Use the round wire rack during convection baking.
- Always preheat the oven before convection baking.
- Avoid opening the oven door during cooking - each time the door is opened, the oven loses heat and this will cause uneven baking.
- Metal pans are recommended for all types of baked products, but especially where browning or crusting is important.
- Dark or dull finish metal pans are best for bread and pies because they absorb heat and produce crisper crust.
- Shiny aluminum pans are best for cakes, cookies, or muffins.
- Glass/glass ceramic casserole or baking dishes are best suited for egg and cheese recipes.
- **FOR COMBINATION COOKING**, use glass or glass ceramic containers. Be sure not to use items with metal trim as it may cause arcing (sparking) with oven wall or oven shelf, damaging the cookware, the shelf, or the oven.
- **FOR COMBINATION COOKING**, use glass or glass ceramic containers. Be sure not to use items with metal trim as it may cause arcing (sparking) with oven wall or oven shelf, damaging the cookware, the shelf, or the oven.

### **SENSOR COOKING**

Sensor cooking has an electronic controlled sensor that detects the vapor (moisture and humidity) emitted from the food as it heats. The sensor adjusts the cooking times and power level for various foods and quantities automatically.

### **BEFORE USING SENSOR COOKING**

1. Be sure the exterior of the cooking container and the interior of the oven are dry. Wipe off any moisture with a dry cloth or paper towel.
2. The oven works with foods at normal storage temperature. For example, popcorn would be at room temperature.
3. More or less food than the quantity listed in the chart should be cooked following the guidelines in any microwave cookbook.
4. During the first part of SENSOR COOKING, food name will appear in the display. Do not open the oven door or press the STOP/CLEAR pad during this part of the cycle as it will interrupt the process. When the sensor detects the vapor emitted from the food, remainder of cooking time will appear. Door maybe opened when remaining cooking time appears in the display. Stir or season food as desired.
5. If the sensor does not detect vapor properly when popping popcorn, the oven will turn off and the correct time of day will display. It will also show an ERROR CODE and the oven will turn off.
6. Check food for temperature after cooking. If additional time is needed, continue to cook manually

### **COVERING FOODS**

Some cooks cook better when covered. Use

1. Casserole lid
2. Plastic wrap
3. Wax Paper

Be careful when removing any covering to allow steam to escape away from you.

### **SENSOR COOK MENU:**

1. Touch SENSOR COOK.
2. Press again to cycle through the menu:
  - Bacon
  - Frozen Dinner
  - Rice
  - Frozen Breakfast
  - Frozen Pizza
3. Press START

### **USING SENSOR REHEAT**

1. Touch SENSOR REHEAT
2. Press again to cycle through the menu:
  - Beverage
  - Pizza
  - Soup Sauce
  - Casserole
3. Press START

### **AUTO DEFROST**

The auto defrost feature provides with the best defrosting method for frozen foods. The cooking guide will show you which defrost sequence is recommended for the food you are defrosting.

### **USING AUTO DEFROST**

1. Touch AUTO DEFROST
2. Press again to cycle through the menu:
  - Meat
  - Poultry
  - Fish
3. Press START
4. Press the number keys to set the weight
5. Press START

For added convenience, the AUTO DEFROST includes a built-in beep mechanism that reminds you to check, turn over, separate, or rearrange the food in order to get the best defrost results. Three different defrosting levels are provided: (available is 0.1-6 lbs)

1. MEAT
2. POULTRY
3. FISH

### **MANUAL DEFROST**

You can defrost any frozen food, either raw or previously cooked, by using power level for 30%. For either raw or previously cooked frozen food, the rule of thumb is approximately 4 minutes per pound. For example, defrost 4 minutes for 1 pound of frozen spaghetti sauce. Always stop the oven periodically to remove or separate the portions that are defrosted. If food is not defrosted at the end of the estimated defrosting time, program the oven in 1 minute increments on power level 30% until totally defrosted. When using plastic containers from the freezer, defrost only long enough to remove from the plastic in order to place in a microwave-safe dish.

**OPERATING TIPS**

- For best results, remove fish, shell fish, meat and poultry from its original closed paper or plastic package (wrapper). Otherwise, the wrap will hold steam and juice close to the food, which can cause the outer surface of the food to cook.
- For best results, roll your ground meat into a ball before freezing. During the DEFROST cycle, the microwave will signal when its time to turn the meat over. Scrape off any excess frost from the meat and continue defrosting.
- Place food in a shallow container or on a microwave roasting rack to catch the drips.
- The weight to enter is the net weight in pounds and tenths of pounds (the weight of the food minus the container).
- Before starting, make sure to remove any and all metal twist-ties that often come with frozen food bags, and replace with strings or elastic bands.
- Open containers, such as cartons, before placing in the oven.
- Always slit or pierce plastic pouches/packaging.
- Bend plastic pouches of food to ensure even defrosting.
- Always underestimate defrosting time. If defrosted food is still icy in the center, return it to the microwave oven for more defrosting.
- The length of defrosting time varies according to how solidly the food is frozen.
- The shape of the package affects how quickly food will defrost. Shallow packages will defrost more quickly than a deep block.
- As food begins to defrost, separate the pieces. Separated pieces defrost more easily.
- Use small pieces of aluminum foil to shield parts of food, such as chicken wings, leg tips, fish tails, or areas that start to get warm. Make sure that the foil does not touch the sides, top, bottom of the oven. The foil can damage the oven lining.
- For better results, let food stand after defrosting.
- Turn over food during defrosting or standing time. Break apart and remove food as required.
- The rack allows several foods to be cooked or reheated at one time. However, for the best cooking and reheating, use Turntable ON function and cook with SENSOR COOKING or AUTO COOKING without the rack. When the rack is used, set time and power level manually. Allow plenty of space around and between the dishes. Pay close attention to the cooking and reheating progress. Reposition the foods and reverse them from the rack to turntable and/or stir them at least once during any cooking or reheating time. After cooking or reheating, stir if possible. Using a lower power level will assist in better cooking and reheating uniformity.

## **CLOCK & SETTINGS**

The microwave oven has settings that allow you to customize the operation for your convenience. Below are functions showing the various settings. Touch the **CLOCK & SETTINGS** to cycle through the menu.

1. Clock
2. Control Lock
3. Power Save
4. Volume: Low/Medium/High/Off
5. Pure Air Filter Reset/Off
6. Language
7. Weight LB/KG
8. Demo

## **SETTING THE CLOCK**

The clock can be disabled when the microwave is first plugged in and the **STOP/CLEAR** is selected. To re-enable the clock:

1. Press **CLOCK & SETTINGS**
2. Enter the time using the number pad
3. Press **START**

## **TIME COOKING**

1. Press the number on the keypad for the desired time (ex: 5 minutes and 30 seconds, press 5 3 0)
2. Press **START**

## **INTERRUPTING COOKING**

You can stop the oven during a cycle by opening the door. The oven stops heating and the fan turns off, but the light stays on.

1. To restart cooking, close the door and Touch **START**
2. If you do not want to continue cooking, open the door and touch **STOP**



## OPERATION

### USING ONE TOUCH START

This is a time saving pad that will automatically start cooking 2 seconds after selected.

Numeric key

1, 2, 3.....or 9 can be touched for a 1 minute, 2 minutes or 9 minutes automatic start cooking feature.

1. Press the number on the keypad for the desired time (ex: 2 minutes, press 2)
2. Press START

Note: "Food" will be displayed if a quick start cooking cycle or +30 sec key is not selected within 5 minutes of placing food in the microwave. You must open then close the door again to clear "Food" from the display.

### SETTING TIMED COOKING WITH POWER LEVEL

This feature lets you program a specific cook time and power. For best results, there are 11 power level settings in addition to HIGH (100%) power.

1. Press the number on the keypad for the desired time (ex: 5 minutes and 30 seconds, press 5 3 0)
2. Press POWER LEVEL
3. Press START

<b>PRESS POWER LEVEL PAD NUMBER OF TIMES FOR DESIRED POWER</b>	<b>APPROXIMATE PERCENTAGE OF POWER</b>	<b>COMMON WORDS FOR POWER LEVELS</b>
POWER LEVEL x 1	100%	High
POWER LEVEL x 2	90%	
POWER LEVEL x 3	80%	
POWER LEVEL x 4	70%	Medium High
POWER LEVEL x 5	60%	
POWER LEVEL x 6	50%	Medium
POWER LEVEL x 7	40%	
POWER LEVEL x 8	30%	Med Low/Defrost
POWER LEVEL x 9	20%	
POWER LEVEL x 10	10%	Low
POWER LEVEL x 11	0%	

### SETTING TWO-STAGE COOKING

For best results, some recipes call for different power levels during a cook cycle . You can program your oven for two power level stages during the cooking cycle. Suppose you want to set a 2-stage cook cycle. The first stage is a 3 minute cook time at 80% cook power then a 7 minute cook time at 50% cook power.

1. Press the numbers on the keypad to set cook time for the first stage. (ex: 3 minutes, press 3 0 0)
2. Press POWER LEVEL three times
3. Press the numbers on the keypad to set cook time for the second stage. (ex: 7 minutes, press 7 0 0)
4. Press POWER LEVEL six times
5. Press START

### SETTING CONTROL LOCK

1. Press CLOCK & SETTINGS two times to get to CONTROL LOCK
2. Press START
3. To turn off, touch the CLOCK & SETTINGS and touch START

### SETTING POWER SAVE ON/OFF

1. Press CLOCK & SETTINGS three times to get to POWER SAVE OFF
2. Press START to toggle between ON & OFF

### TURNING SOUND LOW/MED/HIGH/OFF

Audible signals are available to guide you when setting and using your oven.

- A programming tone will sound each time you touch a pad
  - Three tones signal the end of a kitchen timer countdown
  - Three tones signal the end of a cooking cycle
1. To adjust, press CLOCK & SETTINGS four times to get to VOLUME ON
  2. Keep pressing to cycle through the options: ON, OFF, LOW, MED, HIGH
  3. To set, press START

### SETTING FILTER RESET/FILTER OFF

Select FILTER RESET to turn off "FILTER" icon and reset to remind in 6 months; if you want to turn off "FILTER" icon notification and not remind at all, select FILTER OFF and press START

1. Press CLOCK & SETTINGS and cycle through until you get to FILTER RESET
2. Press START to toggle between FILTER RESET/OFF

### SETTING LANGUAGE

There are two languages available: ENGLISH and FRENCH

1. Press CLOCK & SETTINGS and cycle through until you get to FRENCH
2. Press START to toggle between ENGLISH and FRANCAIS

### SETTING WEIGHT TO LB/KG

There are two weight units available: LB/KG

1. Press CLOCK & SETTINGS and cycle through until you get to LB/KG
2. Press START to toggle between KG to LB

### SETTING DEMO MODE ON/OFF

When DEMO mode is on, programming functions will work in a rapid countdown mode with no cooking power

1. Press CLOCK & SETTINGS and cycle through until you get to DEMO OFF
2. Press START to toggle between ON and OFF

### SETTING KITCHEN TIMER

The microwave oven can be used as a kitchen timer. Set up from 99 minutes to 99 seconds.

The kitchen timer can be used while the microwave oven is running.

- The timer will not stop if the door is open. To cancel the timer, press TIMER ON-OFF
1. Press TIMER ON-OFF
  2. Use the number keypad for the time to count down to
  3. Press TIMER ON-OFF to start counting down

## OPERATION

### **USING VENT FAN**

The pad controls the 2-speed vent fan. The vent fan will go from HIGH, LOW, OFF.

1. Press the VENT icon
2. To turn off, cycle through the options until the fan is off.

If the temperature from the range or cooktop below the oven gets too hot, the vent fan will automatically turn on to protect the oven. It may stay on up to an hour to cool the oven.

When this occurs, the vent pad will not turn the fan off.

### **USING COOKTOP LIGHT**

The pad controls the 3-setting cooktop light. The vent fan will go from HIGH, LOW, OFF.

1. Press the LIGHT icon
2. To turn off, cycle through the options until the fan is off.

## TROUBLESHOOTING

Check your problem by using the chart below and try the solutions for each problem. If the microwave oven still does not work properly, contact the nearest authorized service center.

Trouble	Possible Cause	Possible Remedy
Oven won't start	Electrical cord is unplugged. Door is open. Wrong operation is set.	Plug into the outlet. Close the door and retry. Check instructions.
Arcing or sparking	Materials to be avoided in microwave oven were used. The oven is operated when empty. Spilled food remains in cavity.	Use microwave-safe cookware only. Do not operate with oven empty. Clean cavity with wet towel.
Unevenly cooked food	Materials to be avoided in microwave oven were used. Food is not defrosted completely. Cooking time, power level is not suitable. Food is not turned or stirred.	Use microwave-safe cookware only. Completely defrost food. Use correct cooking time, power level. Turn or stir food.
Overcooked foods	Cooking time and/or power level is not suitable.	Use correct cooking time and/or power level.
Undercooked food	Materials to be avoided in microwave were used. Oven ventilation ports are restricted. Cooking time and/or power level is not suitable. Food is not turned or stirred.	Use correct cooking time and/or power level. Check to see that oven ventilation ports are not restricted. Use correct cooking time and/or power level. Turn or stir food.
Improper Defrosting	Materials to be avoided in microwave were used. Cooking time, power level is not suitable. Food is not turned or stirred.	Use microwave-safe cookware only. Use correct cooking time, power level. Turn or stir food.



ZLINE

KITCHEN AND BATH

**Three Locations:**

350 Parr Circle  
Reno, NV 89512

916 Delaware Avenue  
Marysville, OH 43040

319 Rowland Mill Road  
Bruceton, TN 38317

[www.zlinekitchen.com](http://www.zlinekitchen.com)

**1-614-777-5004**