

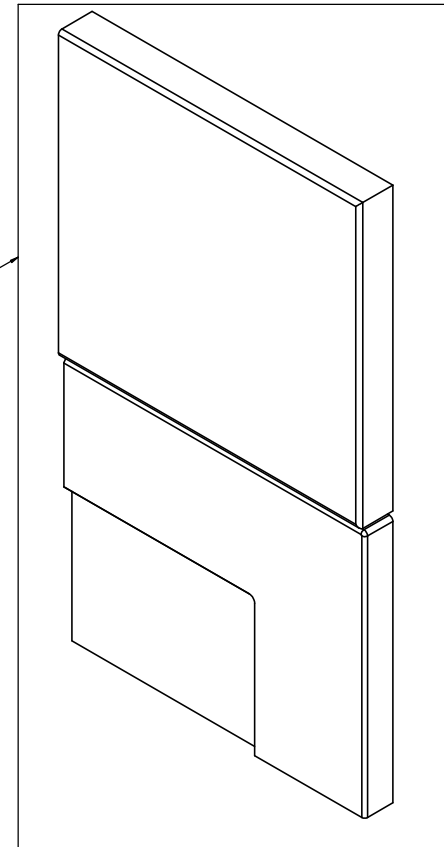

Item ID	Front Thickness [in] mm	Door Thickness [in] mm
CM2135B-WH	[.63] 16	[.63] 16

This profile belongs to CM2135B-WH

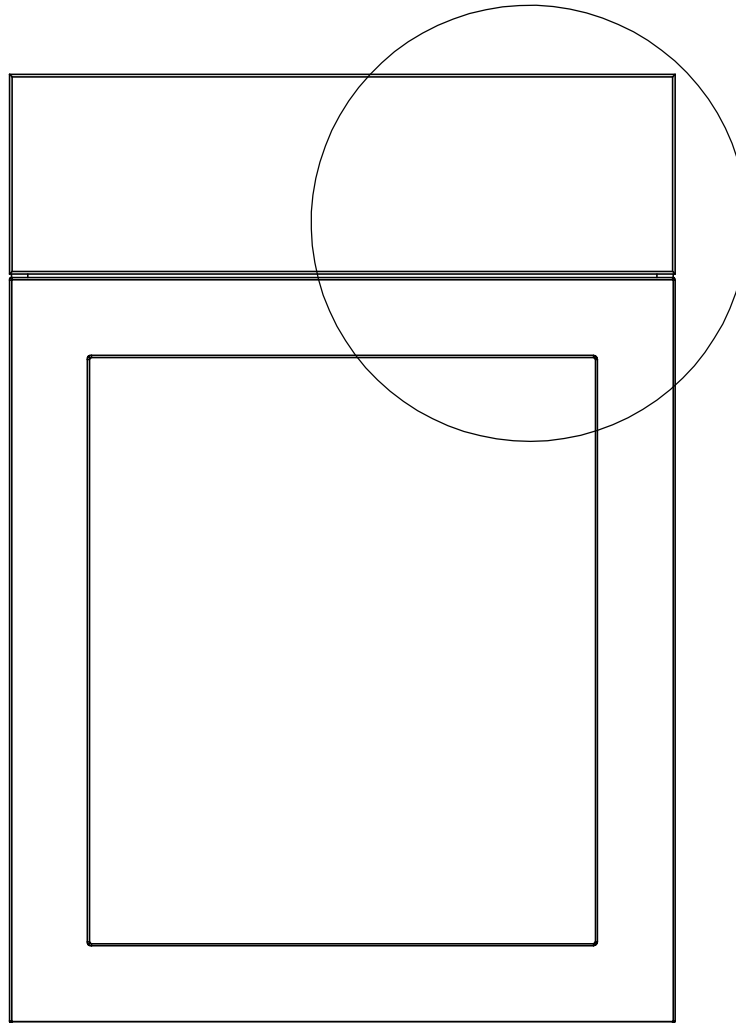

Detailed View

<b>Profile: Cambridge White &amp; Kitchen Gray</b>	
<small>PROPRIETARY AND CONFIDENTIAL</small> THE INFORMATION CONTAINED IN THIS DRAWING IS THE SOLE PROPERTY OF WOODCRAFTERS. ANY REPRODUCTION IN PART OR AS A WHOLE WITHOUT THE WRITTEN PERMISSION OF WOODCRAFTERS IS PROHIBITED.	<small>UNLESS OTHERWISE SPECIFIED</small> DIMENSIONS ARE IN MM AND [INCHES] TOLERANCES ARE +.039[1]-.039[1] SCALE:1:2
	

Item ID	Depth "X"
BT3612R-WH	12.6
BT3612R-BT	12.5
BT3612R-RC	12.6
CM3612R-WH	12.6
CM3612R-DK	12.5
EH3612R-GB	12.6
CM3612R-KG	12.5

REV	ECO#	DESCRIPTION	REV'D BY DATE	CHK'D BY DATE	APRV'D BY DATE
0		New Release	ASG 9/5/17	ASG 9/5/17	ASG 9/5/17

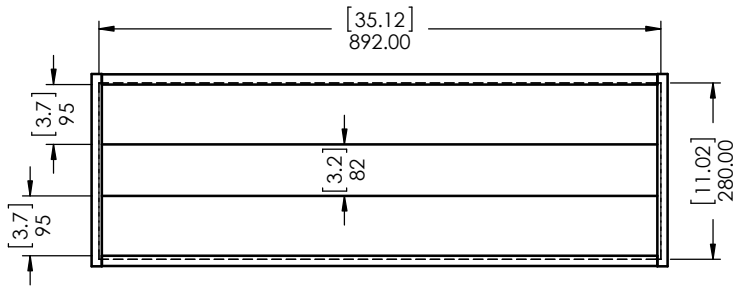

BACK VIEW

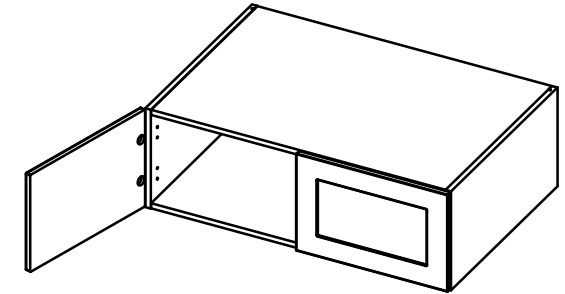
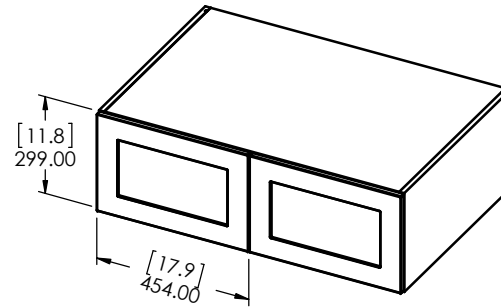

ISOMETRIC VIEW

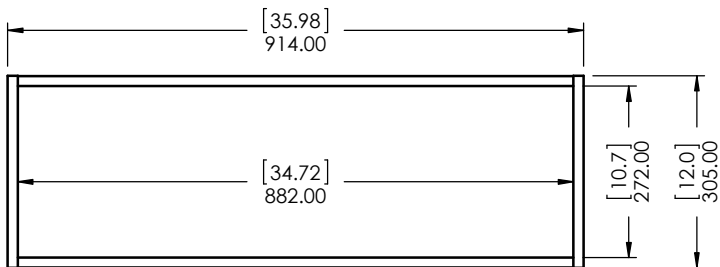

Front View  
(front door  
removed)

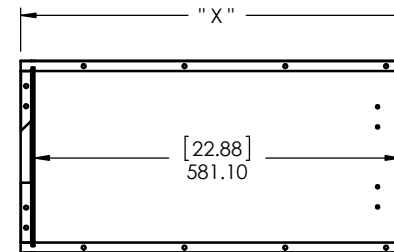

Side View  
(left panel  
removed)

**PROPRIETARY AND CONFIDENTIAL**  
THE INFORMATION CONTAINED IN THIS DRAWING IS THE SOLE PROPERTY OF WOODCRAFTERS HOME PRODUCTS L.L.C. ANY REPRODUCTION IN PART OR AS A WHOLE WITHOUT THE WRITTEN PERMISSION OF WOODCRAFTERS HOME PRODUCTS L.L.C. IS PROHIBITED.

UNLESS OTHERWISE SPECIFIED  
DIMENSIONS ARE IN mm and [inches]  
AND TOLERANCES ARE +/- 0.5[0.02]

DRAWN BY:	A.Salinas	8/23/17
CHECKED BY:	A.Salinas	8/23/17
APPROVED BY:	A.Salinas	8/23/17
DO NOT SCALE DRAWING	SCALE: 1:20	SIZE: <b>A</b>

**Wood Crafters**  
PART NO: **Kitchen Wall Fridge Cabinet 36x12**  
SHEET 1 OF 1  
REV: **0**