

MODEL: RECTANGULAR MIRROR WITH ADJUSTABLE HANGER  
PACKING DIAGRAM

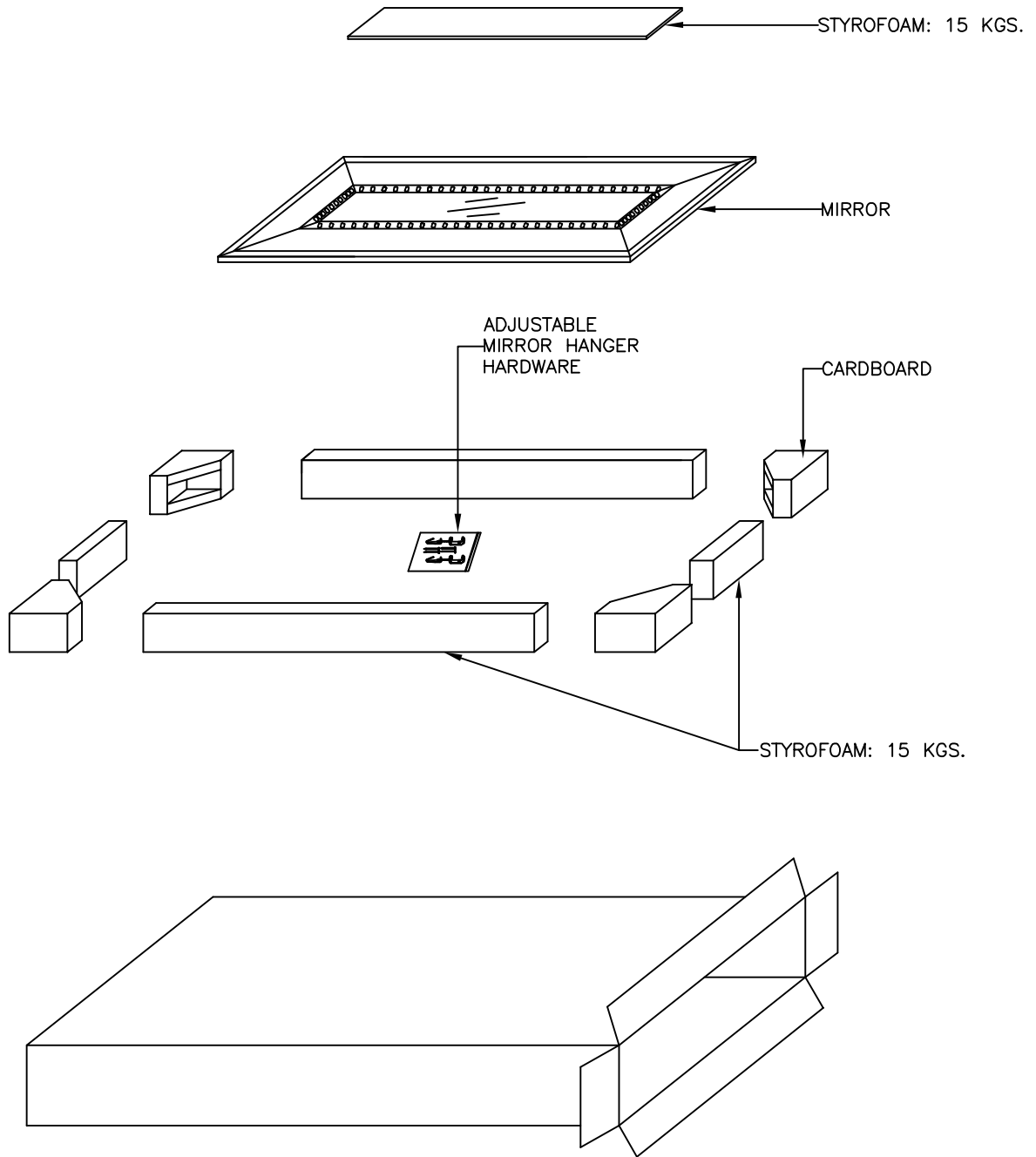



ALL • TOGETHER • BETTER

## USE AND CARE GUIDE

---

RECTANGULAR MIRROR WITH ADJUSTABLE HANGER  
(This mirror is suitable for use in the bathroom)

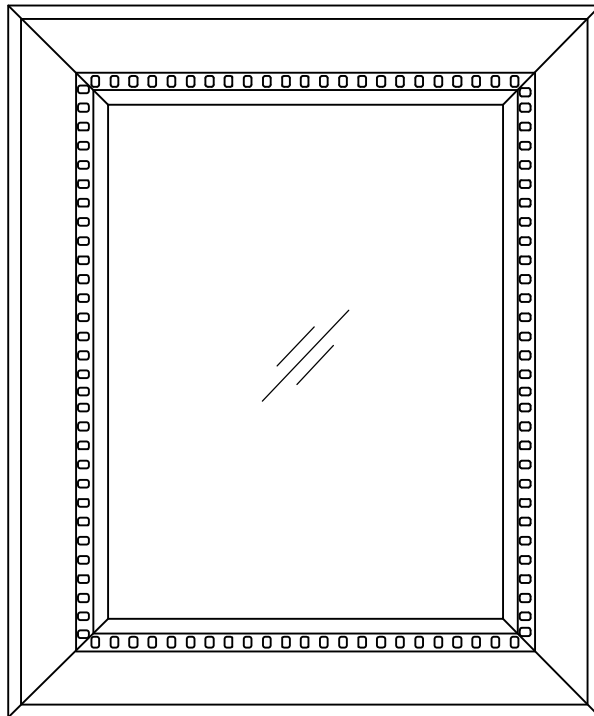

Above image represents many mirrors,  
your mirror may vary in style.

Questions, problems, missing parts? Before returning to the store,  
call Kenroy Home Customer Service  
8 a.m.-6 p.m., EST, Monday-Friday



**904-642-4340**

---

### ***THANK YOU***

We appreciate the trust and confidence you have placed in Kenroy Home through the purchase of this mirror.  
We strive to continually create quality products designed to enhance your home.  
Thank you for choosing us!

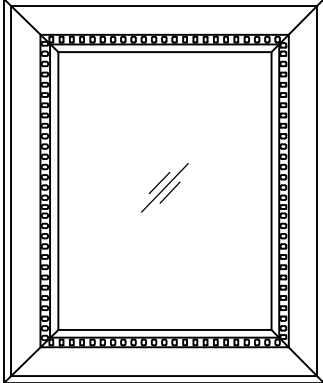
You should have received the following parts in the package.  
Please ensure that all parts are accounted for.

A Mirror	B Mirror Hanger	C Nail
		
Replacement part: MHOOK		
1 PC	2 SETS	4 PC

### SUGGESTED TOOLS (NOT SUPPLIED)

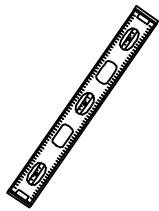

Level



Pencil

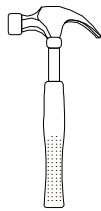

Hammer

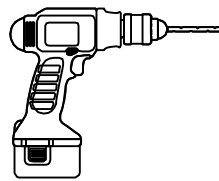

Drill

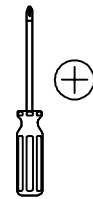

Phillips  
Screwdriver

NOTE: This mirror is suitable for use in the bathroom.

# Installation instructions

**1.** This mirror can be mounted vertically or horizontally. Measure the distance between the brackets that will be used to hang the mirror.

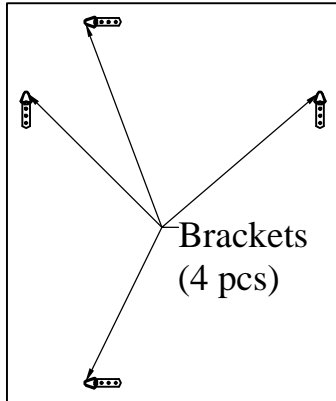

**2.** Place mirror hangers (B) on the wall in desired location, mark spots on the wall.

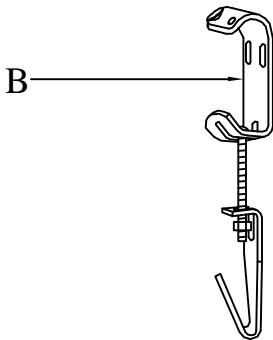

If fastening the mirror hangers to studs,  
please see below:

**3A.** Secure (2) mirror hangers (B) to wall with (4) supplied nails (C).

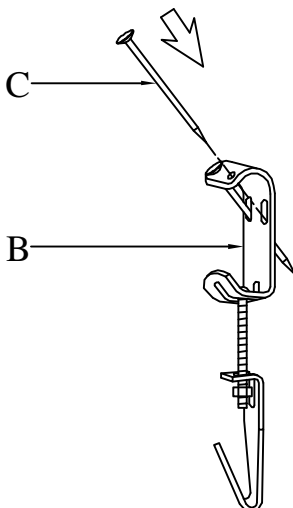

If fastening the mirror hangers to drywall,  
please see below:

**3B.** Drill pilot holes on the marked spots and insert (4) plastic anchors (not supplied).

**3C.** Secure (2) mirror hangers (B) to wall with (4) wood screws (not supplied).

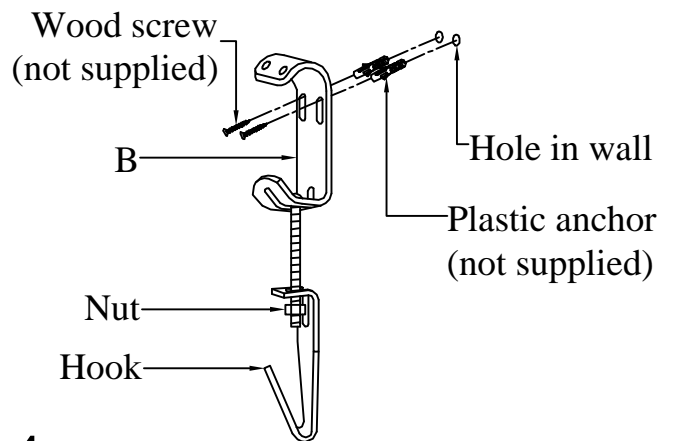

**4.** Hang mirror (A) to wall by attaching the hooks to brackets on back of the mirror.

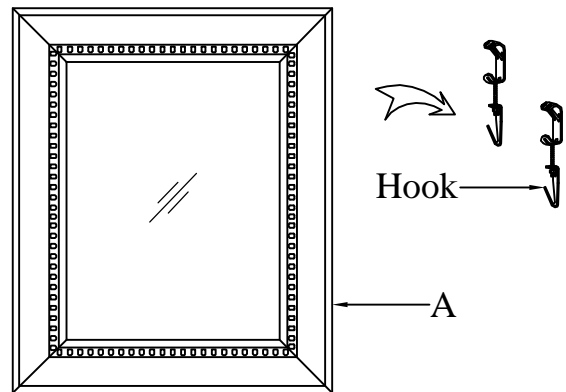

**5.** Adjust the nuts on the mirror hangers (B) to make sure the mirror (A) is level.

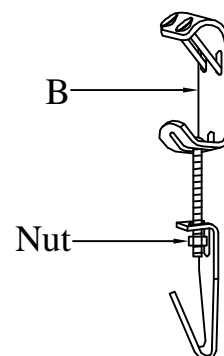



ALL • TOGETHER • BETTER



[www.kenroyhome.com](http://www.kenroyhome.com)

---

## CUSTOMER SUPPORT TEAM

For any additional questions or concerns please contact our Customer Support Team:

 **904-642-4340**

 **@KenroyHome**

 **[customerorders@kenroyhome.com](mailto:customerorders@kenroyhome.com)**