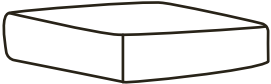
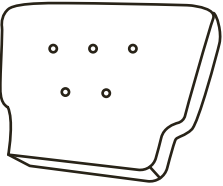
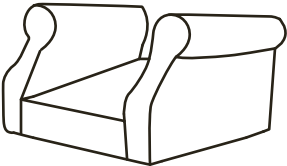
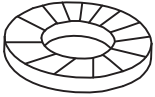

# ASSEMBLY INSTRUCTION

Please read the instruction carefully before assembly.

Part #	Reference Image	Description	QTY
<b>A</b>		Chair Leg	<b>4</b>
<b>B</b>		Cushion	<b>1</b>
<b>C</b>		Chair Back	<b>1</b>
<b>D</b>		Chair Base	<b>1</b>
<b>E</b>		Washer	<b>4</b>

Please check and make sure you have all the parts available before you start with the assembly.

Assembly should be performed on a clean and soft surface, e.g. flat carton box can be used.

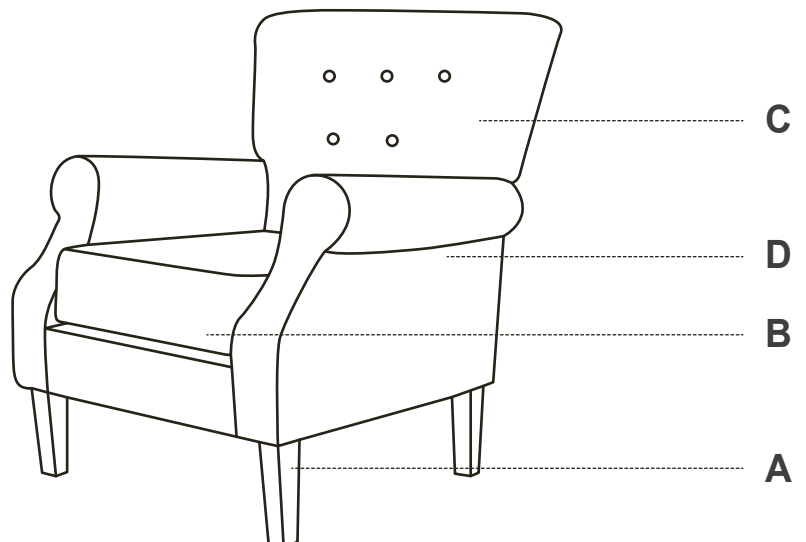

## STEP 1

Please stand behind the chair and gently insert chair back into the chair base. Firmly but gently, push the chair back downwards until the back is fully slotted and locked into position. Please make sure there is no gap between the back and chair base.

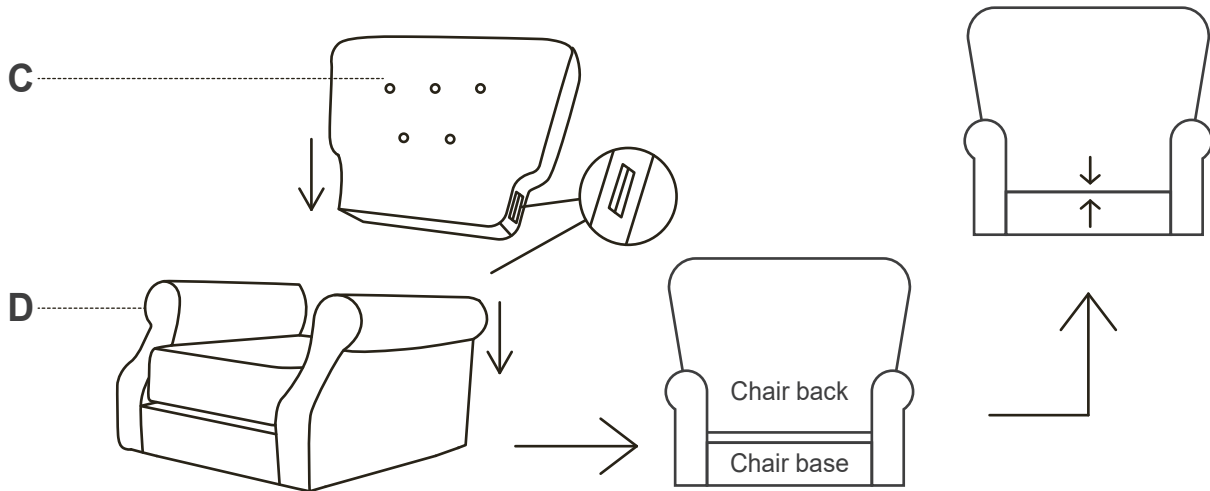

## STEP 2

Lay down the chair base. Put one washer on one leg, then insert threaded leg into the mounted position. Gently screw the leg into chair base. Make sure the leg is screwed tightly. Repeat the same process for the other 3 legs.

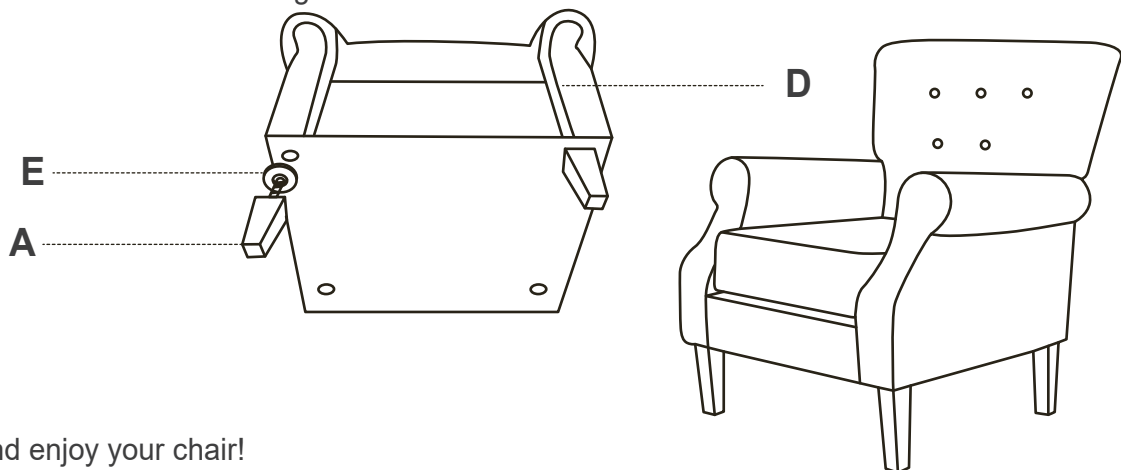

## STEP 3

Finish and enjoy your chair!

### **CAUTION! THE CHAIR CAN ONLY BE USED ON A FLAT SURFACE TO AVOID ANY ACCIDENTS.**

#### Care and Maintenance

1. Do not place it near any fire, heater, or flame.
2. Do not clean it with any sharp cleaning tools as this may damage the fabric.
3. For indoor use only, avoid any patio purposes.
4. Place it in dry and cool place, avoid direct sunlight.
5. Clean it with mild soap and damp non-colored cloth.
6. Please do not write or draw on it, such stains may be permanent.
7. Children should not climb or jump on the chair.
8. Small parts-Choking Hazard- Not for children.