

Assembly Instructions

Caution : You must read this before you proceed

Table

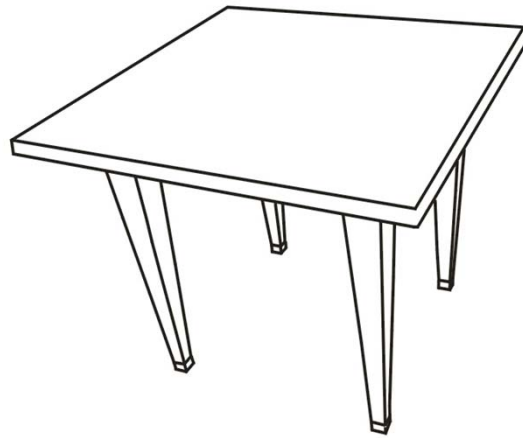

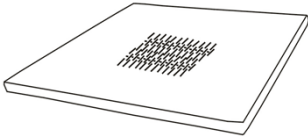
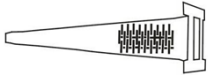

CAUTION : This Table is NOT a TOY.
Keep your child / children at bay during the assembly process.

Parts List

Label	Picture	Description	QTY
A		Woven Table Top	1
B		Table Leg	4

Hardware

Label	Picture	Description	QTY
C		Allen Key	1
D		Screw with Flat Washer Ring	16

Assembly Preparation

Before Beginning Assembly:

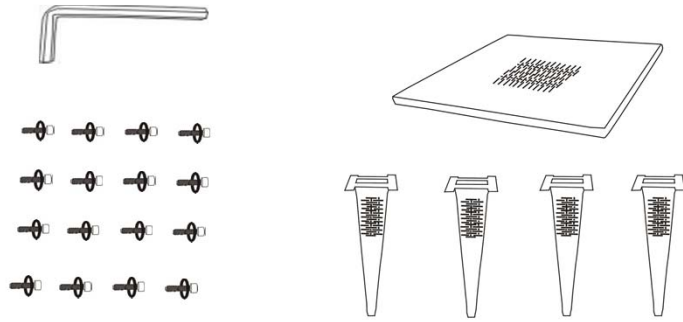

- Read instructions, cover to cover-



- Have 2 adults on hand for assembly-



- Do not assemble on flooring or carpet-



- Assemble on a clean non-marring surface (packing foam)-



- Save all packaging until finished-

Assembly Steps

Step 1

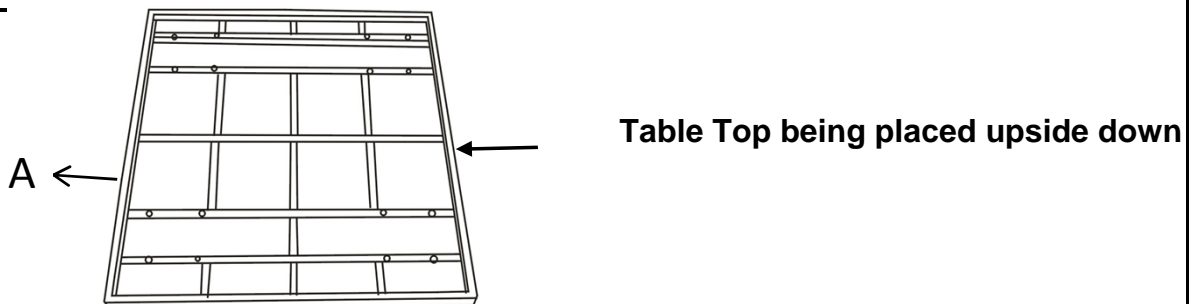

Place the Woven Table Top(A) with top facing downwards on a sofa, clean surface

Step 2

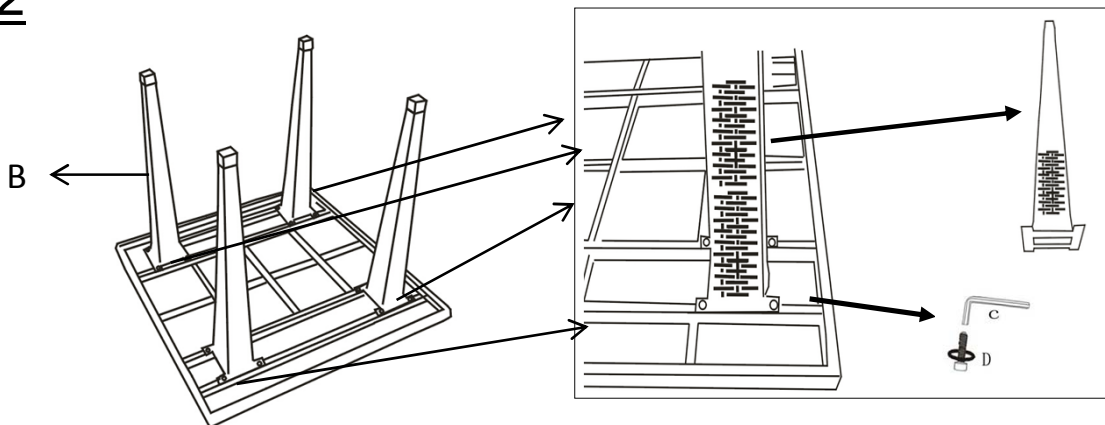

Then, place the table leg(B) over screw points
Attach the screw with Flat Washer Ring(D) onto the contact point as shown in picture. Tighten screw with the Allen Key(C).

Step 3

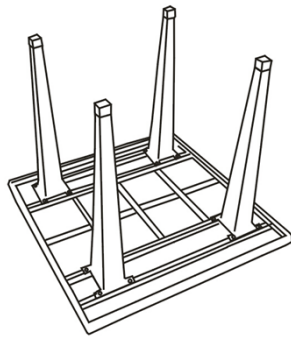





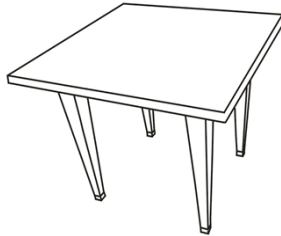













Repeat the same assembly process for the remaining three legs and respective screw points

Step 4



Turn the table **RIGHT** Side Up. Your Table is ready for use.

Care & Maintenance

-   ● Do not put **HOT** items directly on furniture surface.
 -   ● Do not clean furniture with **HARSH** cleansers or polish.
 -   ● To prolong product lifetime, **AVOID** placing furniture under direct sunlight.
 -   ● Do not place furniture near **heating or cooling** vents.
 -   ● Do not write on furniture without a padded barrier to protect the surface.
 -   ● To prolong the product lifetime, avoid extended and lengthy exposure to rain and sunshine. Where possible, place under covers and or patio and or awnings.
 -   ● For residential use only. **Not for commercial use.**
 -   ● Stains may be removed with mild soap solution and damp cloth.
-
-   ● Dust and pick-up spills using a clean, non-colored, lint-free cloth.