



**HIGH-WALL DUCTLESS
AIR CONDITIONING & HEATING SYSTEM
INSTALLATION MANUAL**

Models:

VIR09HP115V1A

VIR12HP115V1A

VIR09HP230V1A

VIR12HP230V1A

VIR18HP230V1A

VIR24HP230V1A

VIR30HP230V1A

VIR36HP230V1A



Thank you for choosing a Vireo Heat Pump for your customer.

Please read this installation manual carefully before installing and starting up the Vireo System. Take a moment to fill out the product and installation form on the back cover. Retain both the manual and installation record for future reference.

Table of Contents

<i>Safety Precautions</i>	2-3
<i>Nomenclature</i>	4
<i>System Requirements</i>	5
<i>Suggested Tools</i>	6
<i>Part Names</i>	7
<i>Installation Site Instructions</i>	8-9
<i>Indoor Unit Installation</i>	10-11
<i>Outdoor Unit Installation</i>	12-13
<i>Piping Installation</i>	14-17
<i>Power and Wiring Installation</i>	18-20
<i>Testing and Inspection</i>	21-23
<i>Troubleshooting</i>	24-25
<i>Diagnostic Codes</i>	26-28
<i>Care and Cleaning</i>	29

SAFETY PRECAUTIONS

Please read the following before operation.

Recognize safety information.  This is the safety-alert symbol. When you see this symbol on the unit and in instructions or manuals, be alert to the potential for personal injury. Understand these signal words: **DANGER**, **WARNING**, and **CAUTION**. These words are used with the safety-alert symbol.

DANGER identifies the most serious hazards which will result in severe personal injury or death.

WARNING signifies hazards which could result in personal injury or death.

CAUTION is used to identify unsafe practices which may result in minor personal injury or product and property damage.

NOTE is used to highlight suggestions which will result in enhanced installation, reliability, or operation.

NOTE: Your actual air conditioning & heating system and related devices may differ from the images shown in this manual.

WARNING

This appliance is not intended for use by children without responsible adult supervision. Proper care should be taken to ensure safety.

WARNING

Heat pumps, air conditioners & heating equipment should be installed, started up, and serviced only by qualified installers and service technicians. Air conditioning, heat pumps and refrigeration systems are hazardous due to high voltage electrical components, high refrigerant pressures, and moving parts.

SAFETY PRECAUTIONS

CAUTION

- *The unit should be installed and serviced only by trained, qualified installers and service technicians. Untrained personnel can perform basic maintenance functions such as cleaning coils. All other operations should be performed by trained service personnel.*
- *Owner should be cautioned that children should not play with the appliance.*

WARNING

ELECTRICAL SHOCK HAZARD

Failure to follow this warning could result in personal injury or death.

- *Before installing, servicing or modifying the system, the main electrical disconnect switch must be in the OFF position. There may be more than one disconnect switch. Lock out and tag all switches with a warning label.*

General Safety Precautions

- *A dedicated power supply circuit should be used in accordance with local electrical safety regulations and National Electrical Codes (NEC).*
- *Ensure that the entire system is properly grounded.*
- *Use a properly sized circuit breaker to protect equipment against short circuit and overload conditions.*
- *The system must be positioned at least 5 feet from combustible surfaces.*
- *Observe all local codes and regulations.*

Installation Site Instructions

A proper installation site is vital for correct and reliable operation of the system.

Avoid the following installation locations:

- *High heat sources, vapors, flammable gas or volatile liquids.*
- *High-frequency electro-magnetic waves, generated by radio equipment, welders or medical equipment.*

NOMENCLATURE

Example: VIR24HP230V 1 A H

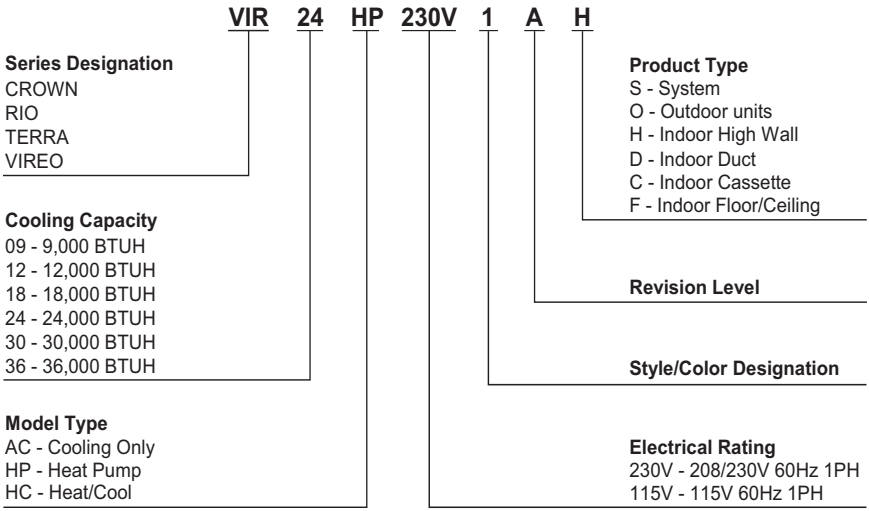

SYSTEM REQUIREMENTS

PIPE SIZE in (mm)

Unit Size (BtuH)	Voltage	Liquid Line	Suction/Gas Line
9,000	115v - 1ph 60hz	1/4 (6)	3/8 (9.5)
12,000	115v - 1ph 60hz	1/4 (6)	1/2 (12)
9,000	208/230v - 1ph 60hz	1/4 (6)	3/8 (9.5)
12,000	208/230v - 1ph 60hz	1/4 (6)	1/2 (12)
18,000	208/230v - 1ph 60hz	1/4 (6)	5/8 (16)
24,000	208/230v - 1ph 60hz	1/4 (6)	5/8 (16)
30,000	208/230v - 1ph 60hz	1/4 (6)	5/8 (16)
36,000	208/230v - 1ph 60hz	1/4 (6)	5/8 (16)

REFRIGERANT LINE LENGTHS ft (m)

Unit Size (BtuH)	Voltage	Min Line Length	Pre-Charge Line Length	Max Line Length	Max Elevation
9,000	115v - 1ph 60hz	10 (3)	25 (7.5)	50 (15)	33 (10)
12,000	115v - 1ph 60hz	10 (3)	25 (7.5)	66 (20)	33 (10)
9,000	208/230v - 1ph 60hz	10 (3)	25 (7.5)	50 (15)	33 (10)
12,000	208/230v - 1ph 60hz	10 (3)	25 (7.5)	66 (20)	33 (10)
18,000	208/230v - 1ph 60hz	10 (3)	25 (7.5)	82 (25)	33 (10)
24,000	208/230v - 1ph 60hz	10 (3)	25 (7.5)	82 (25)	33 (10)
30,000	208/230v - 1ph 60hz	10 (3)	25 (7.5)	98 (30)	33 (10)
36,000	208/230v - 1ph 60hz	10 (3)	25 (7.5)	98 (30)	33 (10)

REFRIGERANT CHARGE

Unit Size (BtuH)	Voltage	Refrigerant Type	Factory System Charge oz (kg)	Additional Charge oz/ft (g/m)
9,000	115v - 1ph 60hz	R410A	42.3 (1.2)	0.16 (15)
12,000	115v - 1ph 60hz	R410A	47.6 (1.35)	0.21 (20)
9,000	208/230v - 1ph 60hz	R410A	45.9 (1.3)	0.16 (15)
12,000	208/230v - 1ph 60hz	R410A	47.6 (1.35)	0.21 (20)
18,000	208/230v - 1ph 60hz	R410A	56.4 (1.6)	0.21 (20)
24,000	208/230v - 1ph 60hz	R410A	77.6 (2.2)	0.54 (50)
30,000	208/230v - 1ph 60hz	R410A	84.7 (2.4)	0.54 (50)
36,000	208/230v - 1ph 60hz	R410A	91.7 (2.6)	0.54 (50)

ELECTRICAL REQUIREMENTS

Unit Size (BtuH)	Voltage	Min Circuit Amps (MCA)	Max Overcurrent Protection (MOP)	Main Power Wire Size (AWG)*
9,000	115v - 1ph 60hz	12	20	12
12,000	115v - 1ph 60hz	17	25	10
9,000	208/230v - 1ph 60hz	9	15	14
12,000	208/230v - 1ph 60hz	9	15	14
18,000	208/230v - 1ph 60hz	16	25	10
24,000	208/230v - 1ph 60hz	20	30	10
30,000	208/230v - 1ph 60hz	20	30	10
36,000	208/230v - 1ph 60hz	24	40	8

*Main power wire from electrical panel to outdoor unit.

- Notes: 1) System must be on a single dedicated circuit.
 2) Main power is supplied to the outdoor unit.
 3) Use table above to size over current protection.
 4) Follow all local building codes and NEC (National Electrical Code) regulations.

Interconnecting Cable: Recommended cable - 14/4 AWG stranded bare copper conductors THHN 600V unshielded wire
 Note: Use shield cable if installation is in close proximity of RF and EMI transmitting devices.

Condensate Drain Size: 5/8-in OD 7/16-in ID



SUGGESTED TOOLS



- *Standard Wrench*
- *Adjustable/Crescent Wrench*
- *Torque Wrench*
- *Hex Keys or Allen Wrenches*
- *Drill & Drill Bits*
- *Hole Saw*
- *Pipe Cutter*
- *Screw drivers (Phillips & Flat blade)*
- *Manifold and Gauges*
- *Level*
- *R410A Flaring Tool*
- *Clamp on Amp Meter*
- *Vacuum Pump*
- *Safety Glasses*
- *Work Gloves*
- *Refrigerant Scale*
- *Micron Gauge*

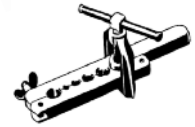

PART NAMES

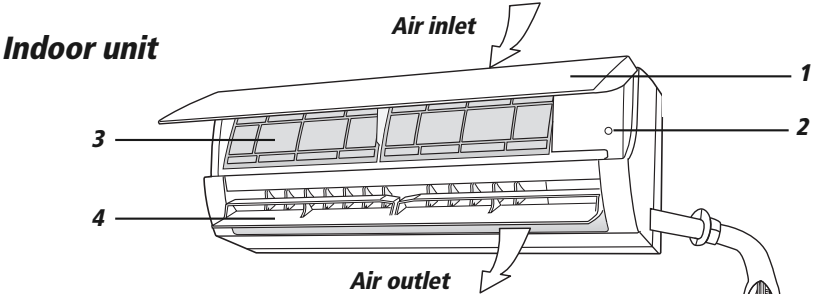

Part Name

- 1. Front Panel
- 2. Aux. Button
- 3. Filter
- 4. Horizontal Louver
- 5. Remote Controller
- 6. Inter-Connection Wire
- 7. Drain Hose
- 8. Refrigerant Lines



Outdoor unit

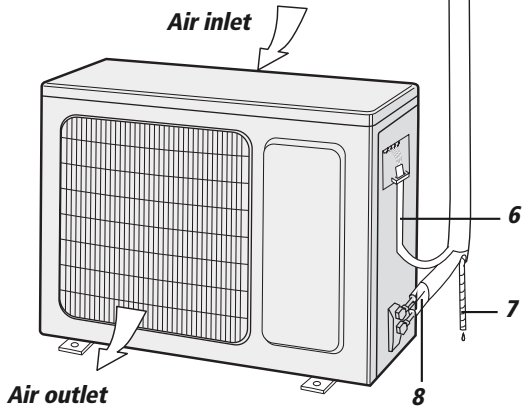

INSTALLATION SITE INSTRUCTIONS

Indoor Unit

Select a site that allows for the following:

1. Ensure the installation complies with the installation minimum dimensions (defined below) and meets the minimum and maximum connecting piping length and maximum change in elevation as defined in the System Requirements section.
2. Air inlet and outlet will be clear of obstructions, ensuring proper airflow throughout the room.
3. Condensate can be easily and safely drained.
4. All connections can be easily made to outdoor unit.
5. Indoor unit is out of reach of children.
6. A mounting wall strong enough to withstand four times the full weight and vibration of the unit.
7. Filter can be easily accessed for cleaning.
8. Leave enough free space to allow access for routine maintenance.
9. Install at least 10 ft. (3 m) away from the antenna of TV set or radio. Operation of the air conditioner may interfere with radio or TV reception in areas where reception is weak. An amplifier may be required for the affected device.
10. Do not install in a laundry room or by a swimming pool due to the corrosive environment.

Minimum Indoor clearances

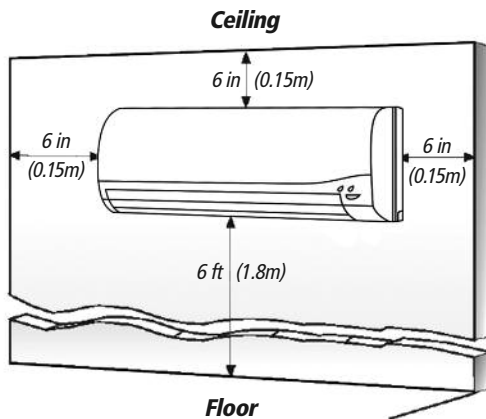

INSTALLATION SITE INSTRUCTIONS

Outdoor Unit

Select a site that allows for the following:

1. Outdoor location meets all minimum installation clearances defined below.
2. Sound from outdoor unit will not annoy neighbors.
3. All connections can be easily made to indoor unit.
4. Air inlet and outlet will be clear of obstructions to ensure proper airflow.
5. Wall or roof is strong enough to withstand the full weight and vibration of the outdoor unit (for wall or roof installation only).
6. Outdoor unit is out of reach of children and does not obstruct walkways.
7. Outdoor unit is not exposed to direct sunlight, excessive dust or strong wind.
8. Condensate water can drain freely during heating
9. Maintenance and repairs can be easily performed on the outdoor unit.
10. Ensure the installation complies with the minimum and maximum connecting piping length and maximum change in elevation as defined in the System Requirements section.

Minimum Outdoor Clearances

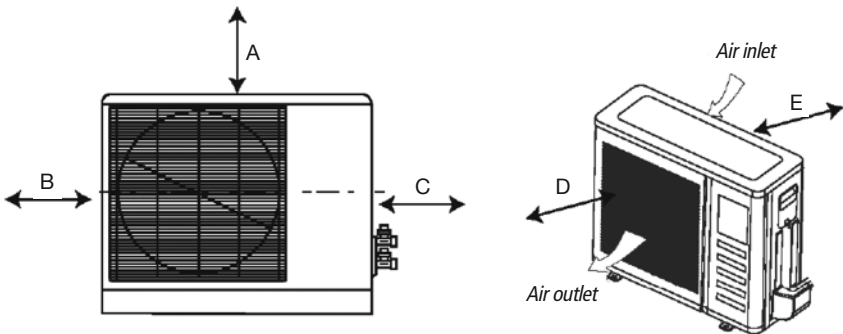

Outdoor Unit	Minimum Distances in (mm)
A	20 (500)
B	12 (305)
C	20 (500)
D	24 (610)
E	12 (305)

INDOOR UNIT INSTALLATION

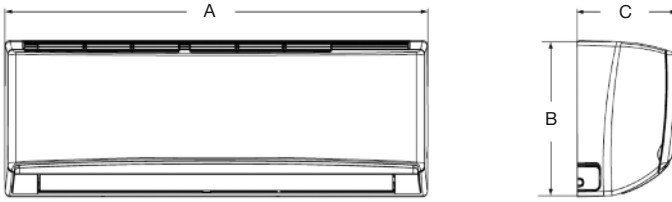

INDOOR UNIT DIMENSIONS in (mm)

Model	A	B	C
VIR09HP115V1A	33.4 (848)	11.4 (290)	8.2 (208)
VIR12HP115V1A	33.4 (848)	11.4 (290)	8.2 (208)
VIR09HP230V1A	33.4 (848)	11.4 (290)	8.2 (208)
VIR12HP230V1A	33.4 (848)	11.4 (290)	8.2 (208)
VIR18HP230V1A	38.2 (970)	11.8 (300)	8.8 (224)
VIR24HP230V1A	42.4 (1077)	12.8 (325)	9.7 (246)
VIR30HP230V1A	53.1 (1349)	12.8 (325)	10 (254)
VIR36HP230V1A	53.1 (1349)	12.8 (325)	10 (254)

Installation of Mounting Bracket

1. Attach the mounting bracket to the indoor unit.
2. Find the horizontal center of the indoor unit.
3. Mark the center of the indoor unit on mounting bracket for future reference.

NOTE: The center of the mounting bracket is not the center of the indoor unit.

4. Remove the mounting brackets from the indoor unit and position the mounting bracket on the wall in desired location. Use centering mark on mounting bracket for centering the indoor unit on the wall.
5. Mounting bracket must be installed horizontally and level right to left.

NOTE: Condensate drain pan has built-in pitch for proper drainage.

6. Secure mounting bracket to wall with a minimum of five screws, evenly spaced to properly support indoor unit weight.

NOTE: It is recommended to install screw anchors for sheet rock, concrete block, brick and such type of walls.

INDOOR UNIT INSTALLATION

Mounting Bracket Diagrams and Dimensions

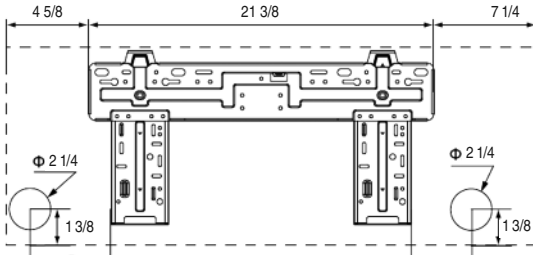

9,000 and 12,000 Units

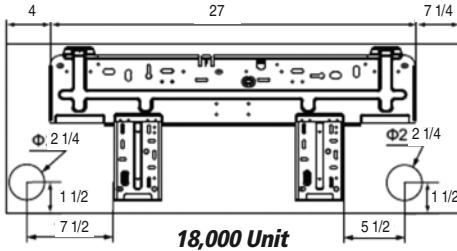

18,000 Unit

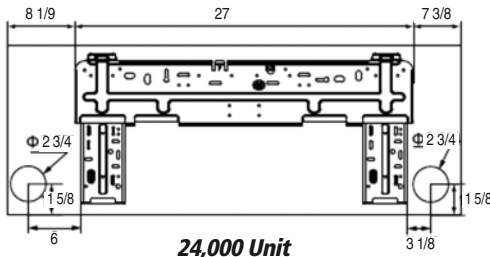

24,000 Unit

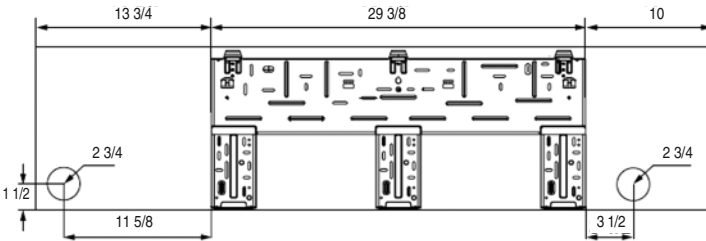

30,000 and 36,000 Unit

OUTDOOR UNIT INSTALLATION

Outdoor Unit Dimensions

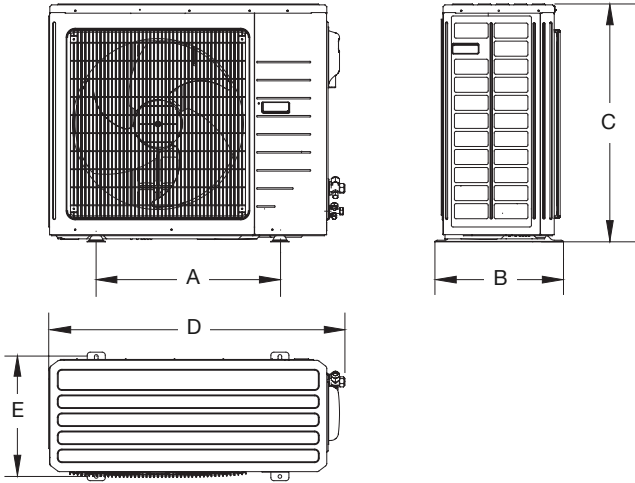

OUTDOOR UNIT DIMENSIONS in (mm)

Model	A	B	C	D	E
VIR09HP115V1A	21.3 (537)	11.3 (285)	21.3 (537)	33.4 (842)	12.6 (318)
VIR12HP115V1A	21.3 (537)	11.3 (285)	21.3 (537)	33.4 (842)	12.6 (318)
VIR09HP230V1A	21.3 (537)	11.3 (285)	21.3 (537)	33.4 (842)	12.6 (318)
VIR12HP230V1A	21.3 (537)	11.3 (285)	21.3 (537)	33.4 (842)	12.6 (318)
VIR18HP230V1A	22 (554)	14.3 (360)	27.6 (696)	37.6 (948)	15.6 (393)
VIR24HP230V1A	24 (605)	16.8 (423)	31.1 (784)	38.6 (973)	16.8 (423)
VIR30HP230V1A	24 (605)	16.8 (423)	31.1 (784)	38.6 (973)	16.8 (423)
VIR36HP230V1A	24 (605)	16.8 (423)	31.1 (784)	38.6 (973)	16.8 (423)

OUTDOOR UNIT INSTALLATION

Ground Pad or Wall Hangers Installation

1. Determine proper location for outdoor unit.
2. Follow all instructions provided by manufacturer for installing wall hangers or ground pad.
3. Verify the wall hangers or ground pad can safely support the weight of the outdoor unit.
4. Verify the wall hangers or ground pad is level and meets all outdoor dimensional clearances.

Outdoor Unit Risers Installation

If the outdoor unit requires added elevation above the ground, installing riser legs will provide a sturdy and stable solution. Follow all instructions provided by manufacturer for installing riser legs to outdoor unit.

NOTE: Riser legs will also help absorb vibrations and noise while facilitating proper drainage.

NOTE: To meet Florida Wind Load criteria, the outdoor unit must be anchored to concrete pad using four $\frac{3}{8}$ -in diameter Power Wedge Bolt Plus (or equivalent) with 1-in diameter fender washers. Anchor bolts must be embedded into 3,000 PSI minimum concrete at a distance of $4\frac{1}{2}$ -in from any concrete edge. The concrete thickness must exceed 1.5 times the anchor depth.

Condensate Drain Installation for Outdoor Unit

During normal heating and defrost operation, the outdoor unit will generate condensate water. The condensate water should be routed to a safe location through the drain hose.

1. Locate and select a drain hole on bottom of outdoor unit.
2. Install the outdoor drain fitting into hole on the bottom of outdoor unit as shown.
3. Connect the drain hose to drain fitting.
4. Route drain hose to safe location for proper drainage of excess condensate water.
5. All non-used drain holes should be plugged.

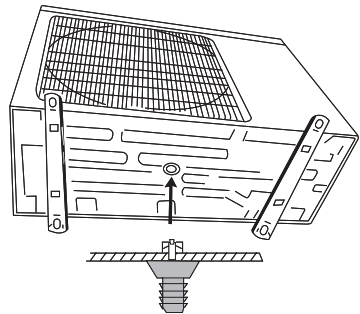

Drain Fitting Installation

PIPING INSTALLATION

Refrigerant Piping

Drill Hole in Wall

If indoor unit refrigerant piping is going to exit from the rear:

1. It is recommended that the refrigerant pipe flare connectors extend through the wall to the outside. In some situations field-fabricated piping extensions will be required to extend the indoor unit refrigerant flare connections to the outside of the wall.
2. Use mounting bracket diagrams and dimensions to find and mark the proper location for the wall hole.

If refrigerant piping is going through the right or left side of front panel:

Carefully cut hole in the side of the front panel for piping to enter indoor unit as shown below. Find and mark the proper location for the wall hole. Use table below to determine recommended wall hole size for your unit size.

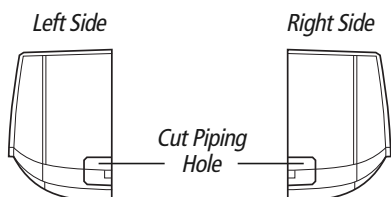
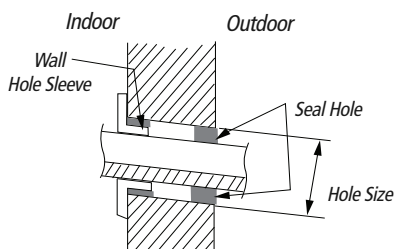

Table of Wall Hole Size per Unit Size

Unit Size (BtuH)	Wall Hole Size (Diameter)	
	in	mm
9,000	2 1/4	55
12,000	2 1/4	55
18,000	2 3/4	66
24,000	2 3/4	66
30,000	2 3/4	66
36,000	2 3/4	66

3. Cut the wall hole with a 5° to 10° downward slant to the outdoors.
4. Insert a wall sleeve into hole to prevent damage to refrigerant pipes, insulation, condensate drain hose and wiring.
5. Proper weather proofing of the wall surface and wall sleeve is essential to assure a trouble-free installation. Apply sealant, caulking or equivalent weather proofing material around the perimeter of the wall sleeve (interior & exterior) to eliminate outdoor air and water leaks into the living space.



Wall Hole Diagram

NOTE: Expandable foam insulation may be added to fill large wall gaps. Apply per manufacturer's instructions.

PIPING INSTALLATION

Refrigerant Piping



CAUTION

Use refrigeration grade piping ONLY. Uses of other piping will void the Manufacturer's Warranty.

Piping Preparation:

1. Do not open service valves or remove protective caps on pipes until all connections are made.
2. Keep tubing free of dirt, sand, moisture and contaminants.
3. Insulate each refrigerant pipe and condensate hose with minimum 3/8" (10 mm) wall thermal pipe insulation.
4. Bind refrigerant pipes, the condensate hose and interconnecting cable together with cable ties at 12-inch intervals.

Piping Connections to Indoor Unit:

NOTE: For maximum serviceability, it is recommended to have refrigerant piping and drain connections on the outside.

1. Feed refrigerant pipes, drain hose and interconnecting wires assembly through wall hole from outdoor to the indoor unit.
2. Adjust the length and carefully bend refrigerant pipes to meet indoor unit refrigerant pipe connections with proper tools to avoid kinks.
3. Apply a small amount of refrigerant oil to the flare connection on the refrigerant pipes.

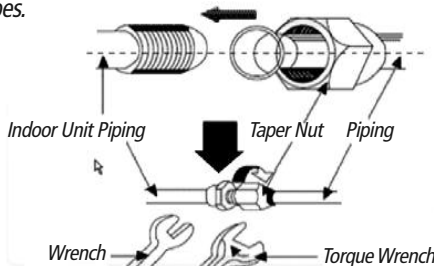
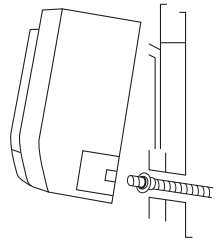

Torque Table

Pipe Diameter inch (mm)	Nut Size inch (mm)	Tightening Torque	
		ft-lbs	N-m
1/4 (6.35)	1/4 (17)	10 to 13	14 to 18
3/8 (9.5)	3/8 (22)	25 to 30	34 to 42
1/2 (12.7)	1/2 (25)	36 to 45	49 to 61
5/8 (15.9)	5/8 (29)	50 to 60	68 to 82

PIPING INSTALLATION

Refrigerant Piping

Piping Connections to Indoor Unit (con't):

4. Properly align piping and tighten flare nut using a standard wrench and a torque wrench as shown in figure to the below. Carefully tighten flare nuts to correct torque level referring to the Torque Table on page 15.

NOTE: Over tightening may damage flare connections and cause leaks.

5. Individually insulate each refrigerant line to prevent sweating.

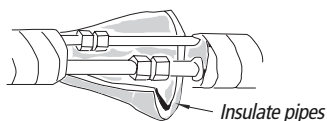

Piping Connections to Outdoor Unit:

1. Remove service valve cover (if provided) to access the service valves and refrigerant ports.
2. Carefully bend and adjust length of refrigerant pipes to meet outdoor unit service valves connections with proper tools to avoid kinks.

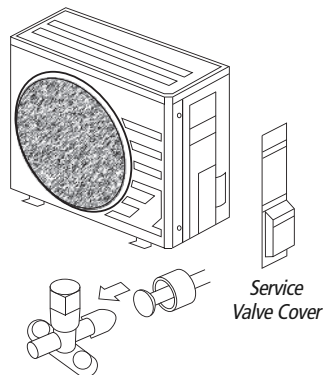

NOTE: Use proper techniques to cut and re-flare refrigerant pipes, if required. An R410A Flaring Tool is required for re-flaring refrigerant pipes.

3. Apply a small amount of refrigerant oil to the flare connection on the refrigerant pipe.
4. Properly align piping and tighten flare nut using a standard wrench and a torque wrench as shown in the indoor piping section.
5. Carefully tighten flare nuts to correct torque level referring to the Torque Table below.

Torque Table

Pipe Diameter inch (mm)	Nut Size inch (mm)	Tightening Torque	
		ft-lbs	N-m
1/4 (6.35)	1/4 (17)	10 to 13	14 to 18
3/8 (9.5)	3/8 (22)	25 to 30	34 to 42
1/2 (12.7)	1/2 (25)	36 to 45	49 to 61
5/8 (15.9)	5/8 (29)	50 to 60	68 to 82

PIPING INSTALLATION

How to Relocate Drain Hose from Left to Right Side (if required)

1. Locate drain plug on right side of the drain tray. Firmly grab it and remove from drain tray.
2. Locate drain tube on the left side of drain tray. Twist drain tube counter-clockwise and gently pull to remove from the drain tray.
3. Position drain tube on the right side over the drain fitting. Push drain tube onto fitting and rotate clockwise to lock. Verify drain tube is secure to prevent leaks.
4. Insert drain plug into left side of drain tray fitting. Verify plug is fully seated to prevent leaks.

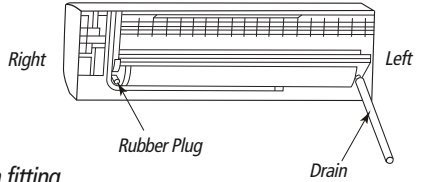

Indoor Drain Piping

The Vireo indoor wall unit uses a gravity drain system. There is no internal condensate pump. The drain hose must slope downward with no kinks, raises or fluctuations.

1. Connect the field supplied drain hose to the outlet pipe of indoor wall unit. A field supplied transition or adapter may be required.
2. Apply pipe insulation to the entire drain line and joints to prevent sweating.
3. The through-wall hole for the drain hose must be lower than the indoor wall unit drain outlet for a functional gravity drain system.
4. Install field supplied drain hose with a downward slope from the Indoor wall unit drain outlet to the drain hose outlet.

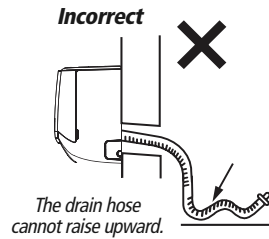
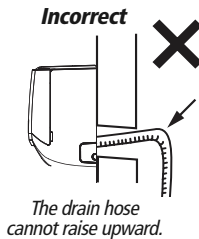
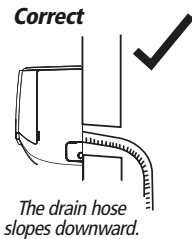
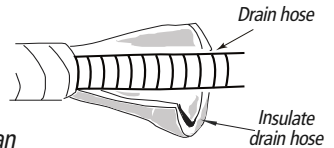
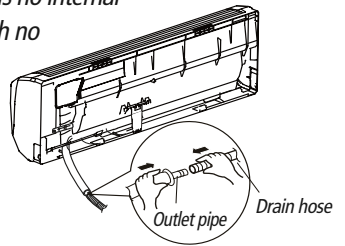

5. Route the condensate drain hose in the safety location to dispose of the condensate water.

POWER AND WIRING INSTALLATION

System Wiring Diagrams

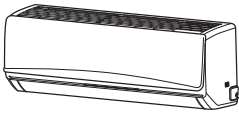

Indoor Unit

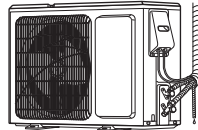

Outdoor Unit

9,000 and 12,000 BtuH
(115V Models)

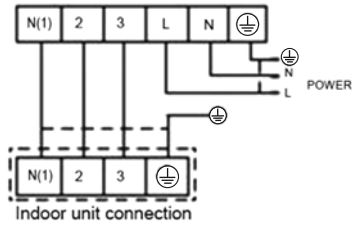

9,000 and 12,000 BtuH
(230V Models)

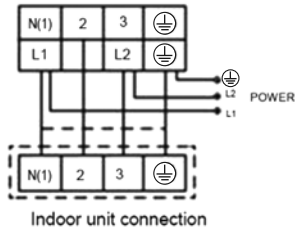

18,000 and 24,000 BtuH
(230V Models)

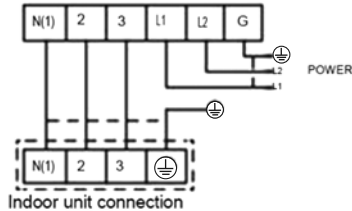

30,000 and 36,000 BtuH
(230V Models)

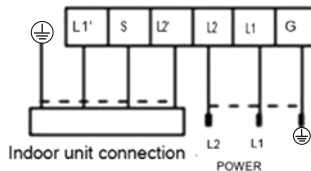

POWER AND WIRING INSTALLATION

Indoor Unit Wire Connections

WARNING

Disconnect all electrical power to indoor and outdoor units including disconnects, fuses and circuit breakers. Lockout and tag all disconnect switches.

1. Open front cover of indoor unit and remove field wiring terminal block cover.
2. Pull interconnecting wires up from back of indoor unit and position in close to the terminal block on indoor unit.

NOTE: Record wire colors and terminal references for uses with Outdoor Unit wire connections.

3. Connect wiring to indoor unit per system wiring diagram.

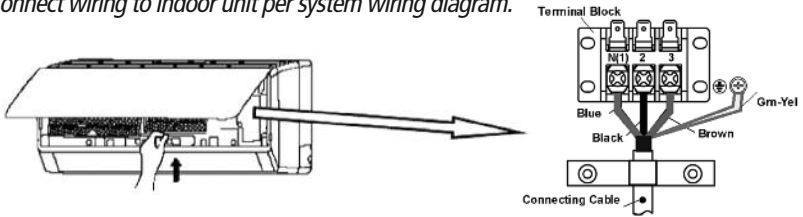

NOTE: The indoor unit is powered from the outdoor unit, depending on local code, a disconnect switch may need to be installed to a power supply circuit.

4. Replace field wiring cover and close front cover of indoor unit.

Indoor Disconnect Switch (If required)

Local codes may require a disconnect switch within sight of the indoor unit. Use a DFS Disconnect Switch Accessory Kit (Part No: DFS-SWITCH-A) to break wires going to the N(1), 2, 3, terminals on the indoor unit, as shown in the wiring diagram below:

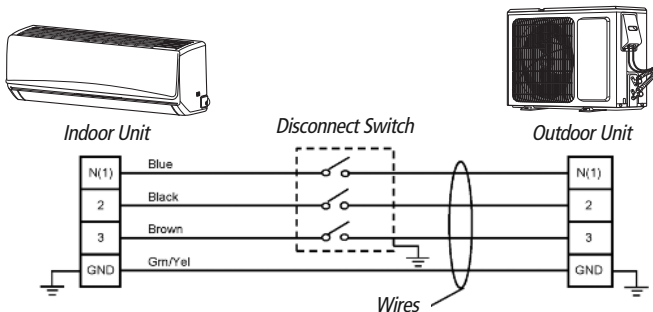

POWER AND WIRING INSTALLATION

Outdoor Unit Wire Connections

WARNING

Disconnect all electrical power to unit including disconnects, fuses and circuit breakers. Lockout and tag all disconnect switches.

1. Remove the service panel on right side of the outdoor unit.
2. Insert interconnecting wires and main power wires through the wire holes on conduit mounting bracket.
3. Secure main power conduit (and interconnecting wire conduit, if required) with locking nuts to conduit mounting bracket.
4. Open wire clamp/strain relief and adjust wire lengths for proper connections to the outdoor unit terminal block.

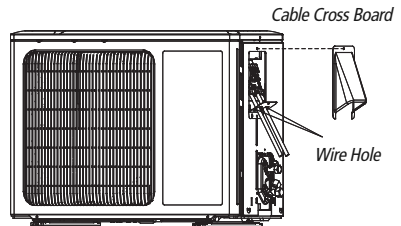

5. Following the same wire colors and terminal references from the indoor unit, tightly connect interconnecting wires to the outdoor unit terminal block per wiring diagram.

NOTE: Crossing interconnecting wires will cause system malfunction and possible damage.

6. Tightly connect main power wires to outdoor unit terminal block per system wiring diagram.
7. Secure all wires inside wire clamp/strain relief. Verify wires are secure, not loose and no external force on wires affects the connections at the terminals.
8. Replace service panel on right side of the outdoor unit.
9. Connect main power wires and conduit to unit disconnect switch box (field supplied) per manufacturer's instructions, National Electrical Code (NEC) and local electrical codes.

CAUTION

- Electrical Disconnecting means must be provided and shall be located within sight and readily accessible from the unit.
- Failure to follow this caution may result in equipment damage or improper operation.
- All wires running from the indoor to outdoor unit must comply with National Electrical Code (NEC) and local codes.
- All wires must be connected firmly to terminal block to avoid unit malfunction, overheating and possible fire hazard.

TESTING AND INSPECTION

Leaking Test

1. Connect the charging hose of the manifold valve to charge the end of the low-pressure valve.
2. Add dry nitrogen to a pressure of 200 lbs. Tightly close both high- and low-pressure valves.
3. Leak-test flare fittings with soap bubbles. If no leak is detected, release nitrogen.



CAUTION

Use vacuum pump, rather than refrigerant, to discharge air when installing the unit.

Vacuum Procedure

Important: Use a quality Micron Gauge to measure and validate the system vacuum achieved. Do not rely on the scale of a "bourbon tube" type gauge set to validate the depth and quality of the vacuum.

1. Remove the caps of the liquid valve, gas valve and service port.
2. Connect gauge manifold and micron gauge to the service ports provided at the liquid and suction service valves.
3. Connect a vacuum pump to the manifold gauge.
4. Open the lower pressure side of the manifold valve assembly and start the vacuum pump. The switch at the high pressure side of the manifold valve assembly should be kept closed, or evacuation does not fail.
5. Operate vacuum pump until a vacuum of 500 microns or less is achieved. The evacuation duration depends on the vacuum pump size and unit's capacity, generally 20 minutes for the 9,000 BtuH units, to 1 hour for a larger 36,000 BtuH unit.
6. Close the manifold valves and shut off the pump.
 - a. If vacuum holds below 700 microns for 15 minutes, the system can be considered dry and leak free. Go to step 5.
 - b. If vacuum increases to 800 microns or greater, this is an indication of moisture in system or a leak exist. Identify leak and repair as necessary, after which repeat steps 4 and 5. If moisture is suspect, purge system use triple evacuation method using dry nitrogen.

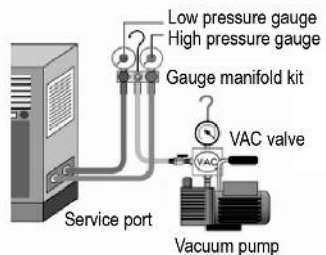

TESTING AND INSPECTION

Vacuum Procedure (con't)

7. Confirm that manifold valves are closed and disconnect the vacuum pump.
8. Open the service valves to the fully 'back-seat' position to let the refrigerant flow to the indoor unit and balance the pressure in system.

Important: Do not allow air to enter the connection pipe when removing the hose.

9. Replace service valve caps and tighten.

Pipe Testing

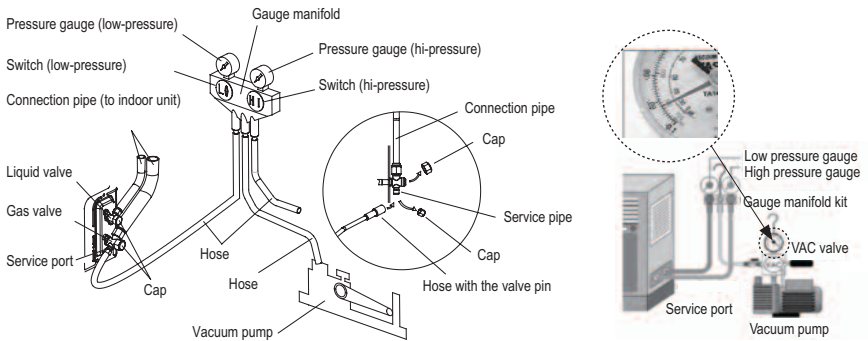

Additional Charge

The outdoor unit contains enough refrigerant charge for up to 25 feet from the factory. When the piping is greater than 25 feet, additional charging is necessary. For the additional amount, see the table below.

Model	Add'l Refrigerant Amount for Extra Pipe
9,000 -18,000	0.21 oz/ft
24,000 - 36,000	0.54 oz/ft

TESTING AND INSPECTION

Oil Return Bend

When the outdoor unit is more than 30 feet above the indoor unit, an oil return bend must be added for every 20 feet of connection pipe.

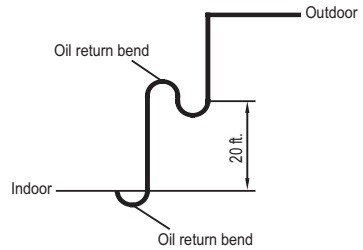

Condensate Drain Pipe Testing

Carefully and slowly add 8-10 ounces of water to the indoor unit drain pan.

- Verify the water drains easily out the condensate drain hose.
- If water does not drain easily from the drain hose, then remove kinks, increase drain pitch, or add an auxiliary condensate drain pump.

Start-up Checklist

Turn on main power to indoor and outdoor units.

- Verify the system is not displaying an error code on the indoor unit display.

Add batteries and press the ON button on the remote controller.

- Verify the remote controller display turns ON and the indoor unit display is ON.

Press the Mode button to Cooling.

Adjust the room setpoint to bring the system on in cooling mode. The system should start cooling mode within 3-5 minutes.

- Verify the outdoor fan and compressor are operating.
- Verify the indoor fan is operating.
- Verify the indoor discharge air is cooling the room.

Press the Mode button to Heating.

Adjust the room setpoint to bring the system on in heating mode. The system should start heating mode within 3-5 minutes.

- Verify the outdoor fan and compressor are operating.
- Verify the indoor fan is operating.
- Verify the indoor discharge air is heating the room.

Press the OFF button on the remote controller.

- Verify remote controller display turns OFF and the system shuts OFF.

TROUBLESHOOTING

PROBLEM	CAUSE/SOLUTION
System does not restart.	<p>Cause: The system has a built-in three-minute delay to prevent short and/or rapid cycling of the compressor.</p> <p>Solution: Wait three minutes for the protection delay to expire.</p>
Indoor unit emits unpleasant odor when started	<p>Cause: Typically unpleasant odors are the result of mold or mildew forming on the coil surfaces or the air filter.</p> <p>Solution: Wash indoor air filter in warm water with mild cleaner. If odors persist, contact a qualified service professional to clean the coil surfaces.</p>
You hear a “water flowing” sound.	<p>Cause: It is normal for the system to make “water flowing” or “gurgling” sounds from refrigerant pressures equalizing when the compressor starts and stops</p> <p>Solution: The noises should discontinue as the refrigerant system equalizes after two or three minutes.</p>
A thin fog or vapor coming out of the indoor unit when system is running.	<p>Cause: It is normal for the system to emit a slight fog or water vapor when cooling extremely humid warm air.</p> <p>Solution: The fog or water vapor will disappear as the system cools and dehumidifies the room space.</p>
You hear a slight cracking sound when the system stops or starts.	<p>Cause: It is normal for the system to make “slight cracking” sounds from parts expanding and contracting during system starts and stops.</p> <p>Solution: The noises will discontinue as temperature equalizes after 2 or 3 minutes.</p>
The system will not run.	<p>Cause: There are a number of situations that will prevent the system from running.</p> <p>Solution: Check for the following:</p> <ul style="list-style-type: none"> • Circuit breaker is “tripped” or “turned off.” • Power button of remote is not turned on. • Batteries in the remote controller are low. • Remote controller is in sleep mode or timer mode. • Otherwise, contact a qualified service professional for assistance.
The unit is not heating or cooling adequately.	<p>Cause: There are a number of reasons for inadequate cooling or heating.</p> <p>Solution: Check the following:</p> <ul style="list-style-type: none"> • Remove obstructions blocking airflow into the room. • Clean dirty or blocked air filter that is restricting airflow into the system. • Seal around door or windows to prevent air infiltration into the room. • Relocate or remove heat sources from the room.
Water leakage from the outdoor unit.	<p>Cause: It is normal for the outdoor unit to generate condensate water in the reverse cycle heating and defrost mode.</p> <p>Solution: This is normal. No action is required.</p>

TROUBLESHOOTING

PROBLEM	CAUSE/SOLUTION
<p>Water leaking from the indoor unit into the room.</p>	<p>Cause: While it is normal for the system to generate condensate water in cooling mode, it is designed to drain this water via a condensate drain system to a safe location.</p> <p>Solution: If water is leaking into the room, it may indicate one of the following.</p> <ul style="list-style-type: none"> • The indoor unit is not level right to left. Level indoor unit. • The condensate drain pipe is restricted or plugged. All restrictions must be removed to allow continuous drainage by gravity. • If problem persists, contact a qualified service professional for assistance.
<p>Wireless remote controller does not work.</p>	<p>Cause: There are a number of possible reasons</p> <p>Solution: Check the following:</p> <ul style="list-style-type: none"> • The remote controller was not matched to the indoor unit. See matching instructions. • The batteries might be low. Change the batteries. • The remote controller must be within 25 ft. (7.5 m) with no obstructions of the indoor unit. If remote controller needs to be replaced, contact a qualified service professional for assistance. In the meantime, use the Aux button to operate the system.
<p>The unit will not deliver air.</p>	<p>Cause: There are a number of system functions that will prevent air flow.</p> <p>Solution: Check for the following:</p> <ul style="list-style-type: none"> • In heating mode, the indoor fan may not start for three minutes if the room temperature is very low. This is to prevent blowing cold air. • In heat mode, if the outdoor temperature is low and humidity is high, the system may need to defrost for up to 10 minutes before beginning a heating cycle. • In dry mode, the indoor fan may stop for up to three minutes during the compressor off delay. • Otherwise, you should contact a qualified service professional for assistance.
<p>Moisture or condensation on the discharge air louvers or outlet vents.</p>	<p>Cause: It is normal for the system to develop condensation or moisture on the discharge air louvers when cooling warm humid air for a long period of time.</p> <p>Solution: The condensation or moisture will disappear as the system cools and dehumidifies the room space.</p>

DIAGNOSTIC CODES

Troubleshooting

The Vireo System has onboard diagnostics. The outdoor unit will provide status indicators. The indoor wall unit and remote controller will display error codes. The following is a summary of the codes with explanation:

Malfunction Name	Indoor Unit & Remote Display	Outdoor Unit Indicators		Possible Causes
		Yellow	Red	
System High Pressure	E1			<ol style="list-style-type: none"> 1) Over charged with refrigerant. 2) Blocked or dirty outdoor coil . 3) Extreme outdoor ambient conditions
Indoor Anti-Freeze Protection	E2	3 flashes and 1 sec Off		<ol style="list-style-type: none"> 1) Low return airflow. 2) Indoor fan speed is too low. 3) Indoor coil is blocked or dirty.
Refrigerant Leakage Protection	F0		9 flashes and 1 sec Off	<ol style="list-style-type: none"> 1) refrigerant leak(s). 2) Indoor coil temperature sensor no calibrated. 3) Refrigerant flow is restricted (ex. valve, exv, debris)
Compressor High Discharge Temperature Protection	E4	7 flashes and 1 sec Off		Please refer to the malfunction analysis (discharge temperature, overload) in service manual.
Overcurrent Protection	E5	5 flashes and 1 sec Off		<ol style="list-style-type: none"> 1) Supply voltage is unstable. 2) Supply voltage is too low and system load is too high. 3) Indoor coil is blocked or dirty.
Communication Malfunction	E6	Continuous On		<ol style="list-style-type: none"> 1) Communication cable is mis-wired between indoor and outdoor units. 2) Indoor or Outdoor control board malfunction.
High Temperature Resistant Protection	E8	6 flashes and 1 sec Off		<ol style="list-style-type: none"> 1) Incorrect refrigerant charge level. 2) Refrigerant metering device malfunction. 3) Compressor malfunction.
EEPROM Memory Malfunction	EE	11 flashes and 1 sec Off		Control board malfunction.
System Configuration Malfunction	C5			<ol style="list-style-type: none"> 1) No jumper cap inserted on the control board. 2) Incorrect or damaged jumper cap on control board. 3) Indoor and outdoor units are not compatible.
Pump Down or Gathering Refrigerant Status	Fo	17 flashes and 1 sec Off		Optional Service Mode

DIAGNOSTIC CODES

Malfunction Name	Indoor Unit Display	Outdoor Unit Indicators		Possible Causes
		Yellow	Red	
Indoor Ambient Temperature Sensor Malfunction	F1			<ol style="list-style-type: none"> 1) Loose or bad connection between sensor and control board. 2) Indoor ambient temperature sensor damaged. 3) Control board malfunction.
Indoor Coil Temperature Sensor Malfunction	F2			<ol style="list-style-type: none"> 1) Loose or bad connection between sensor and control board. 2) Indoor coil temperature sensor damaged. 3) Control board malfunction.
Outdoor Ambient Temperature Sensor Malfunction	F3		6 flashes and 1 sec Off	<ol style="list-style-type: none"> 1) Loose or bad connection between sensor and control board. 2) Outdoor ambient temperature sensor damaged. 3) Control board malfunction.
Outdoor Coil Temperature Sensor Malfunction	F4		5 flashes and 1 sec Off	<ol style="list-style-type: none"> 1) Loose or bad connection between sensor and control board. 2) Outdoor coil temperature sensor damaged. 3) Control board malfunction.
Outdoor Discharge Temperature Sensor Malfunction	F5		7 flashes and 1 sec Off	<ol style="list-style-type: none"> 1) Loose or bad connection between sensor and control board. 2) Discharge temperature sensor damaged. 3) Control board malfunction.
High DC Bus Voltage Protection	PH	13 flashes and 1 sec Off		<ol style="list-style-type: none"> 1) Supply voltage on L1 and N is above 265Vac. 2) Capacitor on control board malfunction. 3) Outdoor control board malfunction.
Low DC Bus Voltage Protection	PL	12 flashes and 1 sec Off		<ol style="list-style-type: none"> 1) Supply voltage on L1 and N is below 150Vac. 2) Capacitor on control board malfunction. 3) Outdoor control board malfunction.
Compressor Phase Current Protection	P5			<ol style="list-style-type: none"> 1) IPM module malfunction. 2) Outdoor control board malfunction 3) Compressor malfunction.
Capacitor Charging Malfunction	PU			Capacitor malfunction
Module Temperature Sensor Malfunction	P7			Outdoor control board malfunction
Module Temperature Protection	P8			<ol style="list-style-type: none"> 1) Lack of thermal grease on IPM module. 2) Heat sink (radiator) not tightly mounted. 3) Control board malfunction.
Compressor Overload Protection	H3	8 flashes and 1 sec Off		<ol style="list-style-type: none"> 1) Wiring terminal OVC-COMP is loose. 2) Refer to the malfunction analysis in Service Manual.

DIAGNOSTIC CODES

Malfunction Name	Indoor Unit Display	Outdoor Unit Indicators		Possible Causes
		Yellow	Red	
IPM Module Protection	H5	4 flashes and 1 sec Off		1) IPM module over heating. 2) Improper or Low voltage at the IPM module. 3) IPM module malfunction.
Indoor DC Fan Motor Malfunction	H6			1) Loose connections between fan motor and control board 2) Fan motor or blower wheel bearings malfunction. 3) Control board malfunction.
Compressor De-Synchronized Malfunction	H7			1) Compressor voltage is not balance. 2) Control board malfunction 3) Compressor malfunction
Power Factor Correction (PFC) Protection	HC	14 flashes and 1 sec Off		1) Mis-wiring of the reactor filter and PFC capacitor. 2) Reactor filter or PFC capacitor malfunction. 3) Control board malfunction.
Outdoor Fan Motor Malfunction	L3		14 flashes and 1 sec Off	1) Loose connections between fan motor and control board 2) Fan motor malfunction. 3) Control board malfunction.
Incompatible Indoor and Outdoor Units	LP	16 flashes and 1 sec Off		Indoor and outdoor units are not compatible.
Start-Up Malfunction	LC			1) Over charged with refrigerant. 2) Control board malfunction. 3) Compressor malfunction.
Compressor Phase-Current Detection Malfunction	U1			Outdoor control board malfunction
DC Bus Voltage Level Dropping Malfunction	U2			Unstable supply voltage
Current Detection Malfunction	U3			Outdoor control board malfunction
Reversing Valve Malfunction	U4			1) Voltage to reversing valve is less than 175V. 2) Loose connections between reversing valve and control board. 3) Reversing valve solenoid malfunction.
Zero Crossing Detection Malfunction	U9			Outdoor control board malfunction
Defrosting Status	note 1	16 flashes and 1 sec Off		

Notes: 1) During defrosting process, the heating indicator is on for 10s and off for 0.5s.
2) Refer to Service Manual for additional information.

CARE AND CLEANING

WARNING

Take notice of the following items before cleaning the Vireo Indoor wall unit.

- To avoid electric shock or injury, do not attempt to clean the unit unless it has been turned off and disconnected from the main power supply.
- Do not wash the unit with water; this may cause an electric shock.
- During cleaning, be sure to use a stable standing platform.

Air Filter Cleaning

Changing your air filter on a regular basis prevents many problems. Dirty air filters will affect the performance and the longevity of your unit. It is recommended that air filters be cleaned every three (3) months.

To access and clean the filter:

1. Open Front Panel

Firmly grasp both sides of the front panel and pull upward to about 60 degree angle. (NOTE: do not force panel open).



2. Remove Filter

Remove the filter as indicated in the figure at right.



3. Clean Filter

Use vacuum to clean the filter.

When the filter is very dirty, use warm water (below 110°F) to clean it, and then dry filter before replacing.

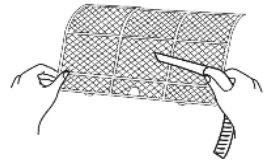

4. Reinstall Filter

Reinstall the filter and then close the panel cover tightly.

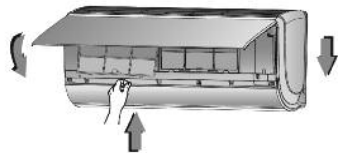



GREE ELECTRIC APPLIANCES, INC.

www.greecomfort.com

PRODUCT & INSTALLATION RECORD

For your convenience, please record the model and serial numbers of your new equipment in the spaces provided. This information, along with the installation data and dealer contact information, will be helpful should your system require maintenance or service.

UNIT INFORMATION

Outdoor Unit:

Model No. _____

Serial No. _____

Indoor Unit:

Model No. _____

Serial No. _____

INSTALLATION INFORMATION

Date Installed: _____

DEALERSHIP/INSTALLER INFORMATION

Company Name: _____

Address: _____

Phone Number: _____

Technician Name: _____

