



Registering your appliance is quick and easy at www.foodsaver.com/register. If you register on our website, you will have the opportunity to receive special bag and accessory introductory offers. Refer to the registration card inside the box.

For important safety information and helpful tips, please visit us at www.foodsaver.com to get tips on vacuum sealing and order FoodSaver® brand accessories, bags and rolls, or call 1-877-777-8042 (U.S.).

©2014 Sunbeam Products, Inc. doing business as Jarden Consumer Solutions. All rights reserved. Distributed by Sunbeam Products, Inc. doing business as Jarden Consumer Solutions, Boca Raton, Florida 33431.



Owner's Manual



FM2000 Models



www.FoodSaver.com



Contents

Important Safeguards & Tips	2
Welcome/Registration	3
Product Features	4
“How To” Section	6
How To Make A Bag From A FoodSaver® Roll	
How To Vacuum Seal With Your FoodSaver® Appliance	
How To Vacuum Seal With Accessories	
How To Use Handheld Sealer with Zipper Bags	
How To Open Vacuum-Sealed Accessories	
Guidelines For Successful Sealing	10
Care & Cleaning	14
Warranty Information	15
Troubleshooting	16
Storage Guide	18

Important Safeguards & Tips

Important Safeguards

For your own safety, always follow these basic precautions when using a FoodSaver® appliance:

1. Read the User Manual carefully for operating instructions. Read all instructions in this manual before use.
2. Do not use appliance on wet surfaces or outdoors.
3. To protect against electric shock, do not immerse any part of appliance, power cord or plug in water or other liquid. Unplug from outlet when not in use and before cleaning.
4. To disconnect, unplug power cord from electrical outlet. Do not disconnect by pulling on cord.
5. Do not operate appliance with a damaged power cord or plug. Do not operate appliance if it malfunctions or is in any way damaged. For details, contact Consumer Services at number listed below.
6. Use appliance only for its intended use.
7. Closely supervise children when using any electrical appliance. Do not allow appliance to be used as a toy.
8. Caution: A short power cord is provided to reduce risks from entanglement or tripping over a longer cord. An extension cord may be used when marked electrical rating is no less than electrical rating of this appliance. All cords should not drape over counter or tabletop where cords can be tripped over or pulled on unintentionally, especially by children.
9. Do not place on or near a hot gas or electric burner, or heated oven. Extreme caution must be used when moving products containing hot liquids.

This appliance has a polarized plug (one blade is wider than the other). As a safety feature, this plug will fit in a polarized outlet only one way. If the plug does not fit fully in the outlet, reverse the plug. If it still does not fit, contact a qualified electrician. Do not attempt to defeat this plug safety feature.

Important Tips

1. Vacuum sealing is NOT a substitute for the heat process of canning. Perishables still need to be refrigerated or frozen.
2. For best results, use only with FoodSaver® Bags, Rolls, Containers and Accessories.
3. During the vacuum sealing process, small amounts of liquids, crumbs or food particles can be inadvertently pulled into the Vacuum Channel. Empty the Drip Tray after each use.
4. Avoid overfilling, always leave at least 3 inches of bag material between bag contents and top of bag. This allows room for the bag material to cinch tightly against the food and prevents the bag from pulling out of the Vacuum Channel during the sealing process. Then leave at least one additional inch of bag material for each time you plan to reuse bag.
5. Do not create your own side seams for a FoodSaver® Bag. These bags are manufactured with a special side seam, which is sealed all the way to the outer edge.
6. To prevent wrinkles in the seal when vacuum sealing bulky items, gently stretch bag flat while inserting bag into Vacuum Channel and continue to hold bag until vacuum pump starts.
7. When you are vacuum sealing items with sharp edges (dry spaghetti, silverware, etc.), protect bag from punctures by wrapping item in soft cushioning material, such as a paper towel. You may want to use a canister or Mason jar instead of a bag.
8. When using accessories, remember to leave one inch of space at top of canister or container.
9. Pre-freeze fruits and blanch vegetables before vacuum sealing for best results. *See Guidelines for Vacuum Sealing, pages 10-13.*
10. Wait 20 seconds between seals to allow appliance to cool.
11. Never store lid in OPERATE position as gaskets may become compressed.

**For Household Use Only
SAVE THESE INSTRUCTIONS**

Welcome to FoodSaver® Vacuum Sealing System

Congratulations...

You are about to enjoy the freshness benefits of FoodSaver®, The #1 Selling Brand of Vacuum Sealing Systems. For years, the FoodSaver® Vacuum Sealing System has helped millions of households keep food fresh longer in the refrigerator, freezer and pantry. The FoodSaver® system is designed to remove air and extend freshness up to five times longer than conventional storage methods. Keep your FoodSaver® appliance on your counter top, and you'll soon discover its convenience and versatility all through the year.

Free Gift with Registration!

Register now and you'll receive a free gift. It's our way of saying "thanks" to you for buying FoodSaver® products.

www.foodsaver.com/register

After registering your product, you'll have exclusive access to special sale items for online registrants only.

*Welcome to the world
of FoodSaver® products!*

Questions?

Contact customer service:

1 (877) 777-8042

or visit us online:

www.FoodSaver.com

***Please do not return this product
to place of purchase.***

FoodSaver® FM2000 Models

FEATURES

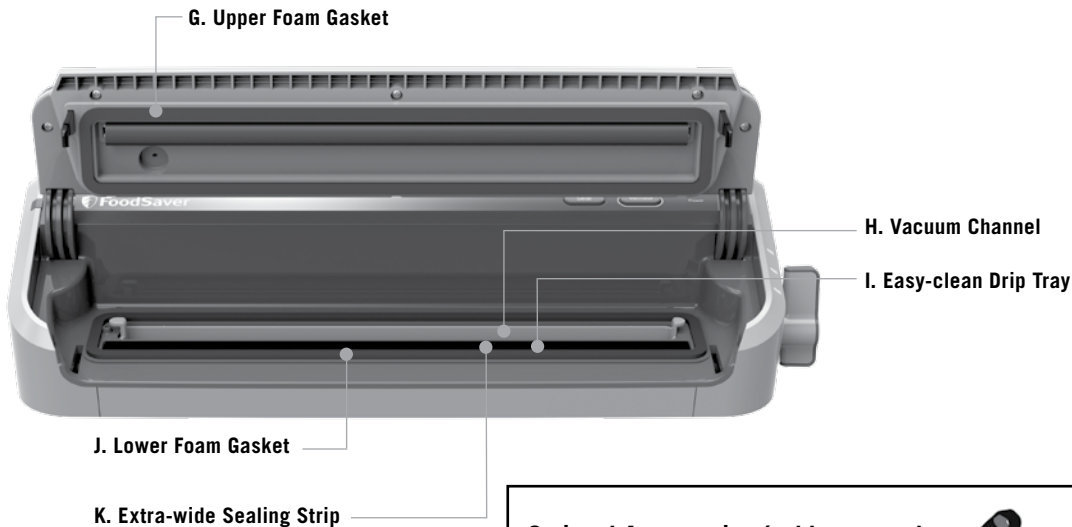
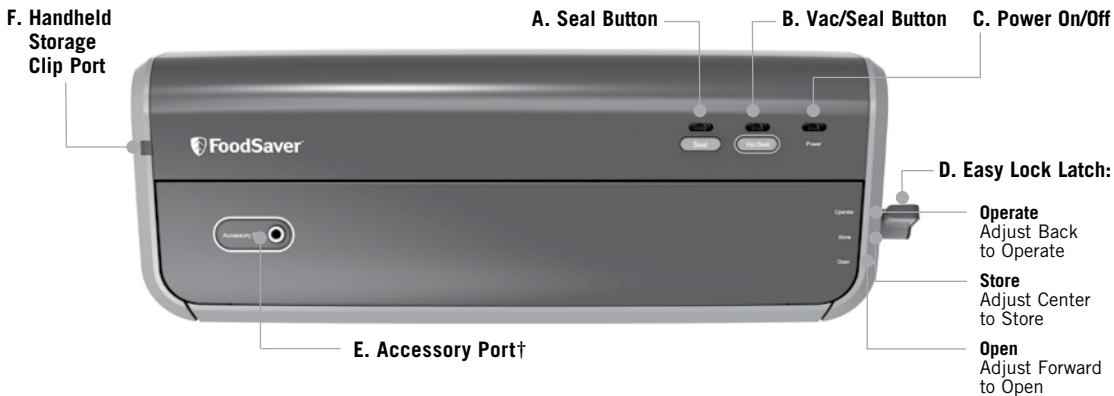

Optional Accessories (sold separately)

1. Handheld Sealer with Clip

Use with zipper bags and canisters, ideal for fresh foods and snacks. Conveniently store Handheld Sealer with appliance using companion clip.

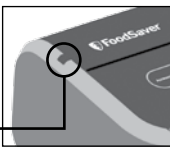
Companion Clip



The user-friendly, intuitive control panel makes it easy for you to get the most out of your FoodSaver® System:

1 Seal Indicator Light

This light has two uses:

1. Constant light indicates Sealing process is engaged.
2. Flashes to indicate error.

2 Vacuum Indicator Light

Shows Vacuum and Seal process is engaged. Shuts off when the full process is finished.

3 Power Light

Illuminates when the unit is in the OPERATE position. Shuts off automatically when latch is not in OPERATE position.

4 Seal Button

This button has three uses:

1. Press to create a seal when making bags from a FoodSaver® Roll.
2. Press to immediately stop the vacuum process and begin sealing the bag. This prevents crushing delicate items such as bread, cookies and pastries.
3. Press to create a seal on multilayer film bags (such as a potato chip bag) to keep food sealed airtight.

5 Vacuum & Seal Button

This button has two uses:

1. Press to vacuum seal and seal food airtight. Appliance shuts off automatically.
2. Press to pause vacuum process at any point.

How to...

1. Make a Bag from a FoodSaver® Roll

1. Using scissors, cut enough bag material from roll to hold item, plus 3 inches. Be sure to cut straight.
2. Move Easy Lock Latch to the open position. Open appliance lid. Insert one end of bag material across Sealing Strip.
3. Close lid and turn Easy Lock Latch to OPERATE position.
4. Press Seal button.
5. When Seal Indicator Light turns off, sealing is complete. Turn latch to OPEN position, lift lid and remove bag.

Now you are ready to vacuum seal with your new bag (see next page).

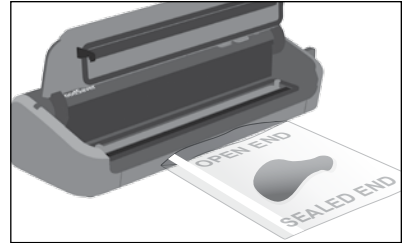

Place Bag on Sealing Strip

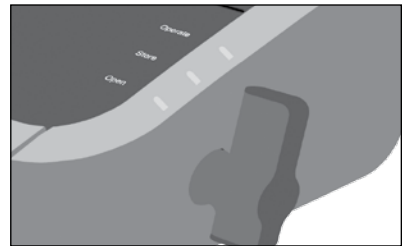

Close and turn Easy Lock Latch to OPERATE position



Press Seal Button

2. Vacuum Seal with FoodSaver® Bags

1. Place item(s) in bag, allowing at least 3 inches of space between bag contents and top of bag.
2. Open appliance lid and place open end of bag into Vacuum Channel.
3. Close lid and turn Easy Lock Latch to OPERATE position.
4. Press Vacuum & Seal Button to begin vacuum and sealing process. Motor will continue to run until bag is fully vacuumed, then will automatically seal.
5. When Seal Indicator Light turns off, turn Latch to OPEN position, lift lid and remove bag. Refrigerate or freeze if needed. (See FoodSaver® Storage Guide, page 18, for safe food storage tips.)

NOTE: Let appliance cool down for 20 seconds after each use. Always store appliance with the Easy Lock Latch in the center STORE position.

Important Tips:

To minimize Waste do not insert too much. Only insert bag over the edge of the removable drip tray.

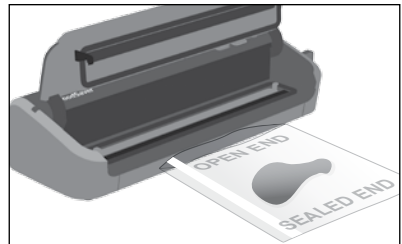

Place Bag in Vacuum Channel

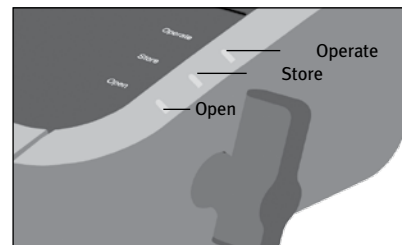

Close and Latch Lid



Press Vacuum & Seal Button

How to...

3. Vacuum Seal with FoodSaver® Accessories

1. Prepare container according to FoodSaver® Accessory Guidelines (see manual that comes with your Accessory Kit).
2. Insert one end of Accessory Hose into Accessory Port on appliance. Insert other end into port on accessory. Twist tab on Accessory Hose while inserting to ensure a tight fit.
3. Close lid, rotate Latch to OPERATE position, press Vacuum & Seal Button.
4. When motor and Indicator Light turn off, vacuum process is complete. Note that the appliance will still go through sealing cycle even when vacuuming an accessory. You will hear Motor shut off and then the sealing cycle will begin.
5. Gently twist and remove Accessory Hose from accessory and appliance.
6. To test vacuum, simply tug on accessory lid. It should not move.

NOTE: For important tips on using accessories with different foods, please refer to the *FoodSaver® Storage Guide* on pages 18-19.

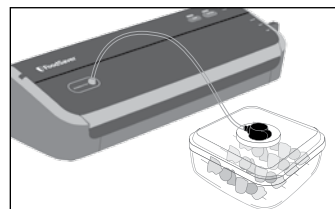

Connect Accessory Hose to both accessory port on appliance & port on accessory



Close and turn Easy Lock Latch to the OPERATE position

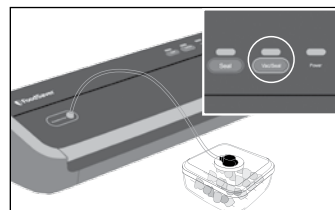

Press Vacuum & Seal Button

4. Use Handheld Sealer with Vacuum Zipper Bags

Handheld sealer can be used with Vacuum Zipper Bags.

1. Fill zipper bag, lay flat with grey circle facing upwards. Squeeze air out, zip 3/4 of the way closed and squeeze any remaining air out before zipping completely.
2. Press Handheld Sealer over gray circle on bag and press Vacuum & Seal button.

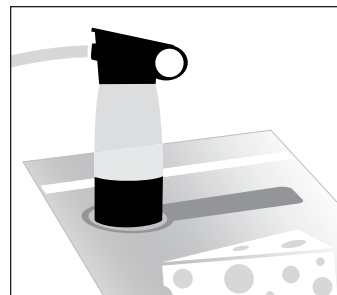

5. Open FoodSaver® Accessories After Sealing

FoodSaver® Vacuum Sealing Canisters (without large knob on lid)

To release vacuum and open, push gray rubber button on lid.



FoodSaver® Bulk Canisters and Quick Marinators (with large knob on lid) and Universal Lids.

To release vacuum and open, turn knob on lid to Open.



FoodSaver® Jar Sealer with Mason Jars

For use with Ball® and Kerr® brand Mason jars only.

Important: Do NOT use screw bands when vacuum sealing jars. To open, wedge spoon between Mason jar lid and highest part of threaded rim. Twist spoon gently to release vacuum.



FoodSaver® Bottle Stoppers

To release vacuum and open, twist and pull up on Bottle Stopper.



FoodSaver® Deli Containers

To release vacuum and open, lift container lid.



Guidelines

For Successful Vacuum Sealing

Vacuum Sealing and Food Safety

The vacuum sealing process extends the life of foods by removing most of the air from the sealed container, thereby reducing oxidation, which affects nutritional value, flavor and overall quality. Removing air can also inhibit growth of microorganisms, which can cause problems under certain conditions:

Mold – Easily identified by its fuzzy characteristic. Mold cannot grow in a low oxygen environment, therefore vacuum sealing can slow the growth of mold.

Yeast – Results in fermentation, which can be identified by smell and taste. Yeast needs water, sugar and a moderate temperature to grow. It causes also survive with or without air. Slowing the growth of yeast requires refrigeration, while freezing stops it completely.

Bacteria – Results in an unpleasant odor, discoloration and/or soft or slimy texture. Under the right conditions, anaerobic bacteria such as *Clostridium Botulinum* (the organism that causes Botulism) can grow without air and sometimes cannot be detected by smell or taste. Although it is extremely rare, it can be very dangerous.

To preserve foods safely, it is critical that you maintain low temperatures. You can significantly reduce the growth of microorganisms at temperatures of 40°F (4°C) or below. Freezing at 0°F (-17°C) does not kill microorganisms, but stops them from growing. For long-term storage, always freeze perishable foods that have been vacuum sealed, and keep refrigerated after thawing.

It is important to note that vacuum sealing is NOT a substitute for canning and it cannot reverse the deterioration of foods. It can only slow down the changes in quality. It is difficult to predict how long foods will retain their top-quality flavor, appearance or texture because it depends on age and condition of the food on the day it was vacuum sealed.

IMPORTANT: Vacuum sealing is NOT a substitute for refrigeration or freezing. Any perishable foods that require refrigeration must still be refrigerated or frozen after vacuum sealing.

Food Preparation and Reheating Tips

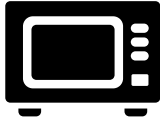

Thawing and Reheating Vacuum-Sealed Foods

Always thaw foods in either refrigerator or microwave — do not thaw perishable foods at room temperature.

To reheat foods in a microwave in a FoodSaver® Bag, always cut corner of the bag before placing it on a microwave-safe dish. However, to avoid hot spots, do not reheat bone-in meat or greasy foods in microwave within a FoodSaver® Bag. You can also reheat foods in FoodSaver® Bags by placing them in water at a low simmer below 170°F (75°C).

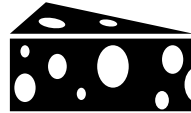

Preparation Guidelines for Hard Cheeses:

To keep cheese fresh, vacuum seal it after each use. Make your FoodSaver® Bag extra long, allowing one inch of bag material for each time you plan to open and reseal in addition to the 3-inch room you normally leave between contents and seal. Simply cut sealed edge and remove cheese. When you're ready to reseal the cheese, just drop it in bag and reseal.

IMPORTANT: Due to the risk of anaerobic bacteria, Soft cheeses should never be vacuum sealed.

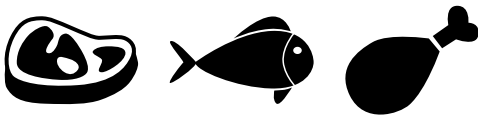

Preparation Guidelines for Meat and Fish:

For best results, pre-freeze meat and fish for 1-2 hours before vacuum sealing in a FoodSaver® Bag. This helps retain the juice and shape, and guarantees a better seal.

If it's not possible to pre-freeze, place a folded paper towel between meat or fish and top of bag, but below seal area. Leave paper towel in bag to absorb excess moisture and juices during vacuum sealing process.

Note: Beef may appear darker after vacuum sealing due to the removal of oxygen. This is not an indication of spoilage.



Preparation Guidelines for Vegetables:

Vegetables need to be blanched before vacuum sealing. This process stops the enzyme action that could lead to loss of flavor, color and texture.

To blanch vegetables, place them in boiling water or in the microwave until they are cooked, but still crisp. Blanching times range from 1 to 2 minutes for leafy greens and peas; 3 to 4 minutes for snap peas, sliced zucchini or broccoli; 5 minutes for carrots; and 7 to 11 minutes for corn on the cob. After blanching, immerse vegetables in cold water to stop the cooking process. Finally, dry vegetables on a towel before vacuum sealing.

Note: All vegetables (including broccoli, brussels sprouts, cabbage, cauliflower, kale, turnips) naturally emit gases during storage. Therefore, after blanching, they must be stored in freezer only.

Food Preparation and Reheating Tips (cont.)

When freezing vegetables, it is best to pre-freeze them for 1-2 hours or until solidly frozen. To freeze vegetables in individual servings, first place on a baking sheet and spread them out so they are not touching. This prevents them from freezing together in a block. Once they are frozen, remove from baking sheet and vacuum seal vegetables in a FoodSaver® Bag. After they have been vacuum sealed, return them to the freezer.

IMPORTANT: Due to the risk of anaerobic bacteria, Fresh mushrooms, onions and garlic should never be vacuum sealed.



Preparation Guidelines for Baked Goods:

To vacuum seal soft or airy baked goods, we recommend using a FoodSaver® Canister so they will hold their shape. If using a bag, pre-freeze for 1-2 hours or until solidly frozen. To save time, make cookie dough, pie shells, whole pies, or mix dry ingredients in advance and vacuum seal for later use.



Preparation Guidelines for Coffee and Powdery Foods:

To prevent food particles from being drawn into vacuum pump, place a coffee filter or paper towel at top of bag or canister before vacuum sealing. You can also place the food in its original bag inside a FoodSaver® Bag, or use a FoodSaver® Universal Lid with the original container to vacuum seal.



Preparation Guidelines for Liquids:

Before you vacuum seal liquids such as soup stock, pre-freeze in a casserole dish, loaf pan or ice cube tray until solid. Remove frozen liquid from pan and vacuum seal in a FoodSaver® Bag. You can stack these “frozen bricks” in your freezer. When you’re ready to use, just cut corner of bag and place in a dish in microwave or drop into water at a low simmer, below 170°F (75°C).

To vacuum seal non-carbonated bottled liquids, you can use a FoodSaver® Bottle Stopper with the original container. Remember to leave at least one inch of room between contents and bottom of Bottle Stopper. You can re-seal bottles after each use.

Preparation Guidelines for Fruits:

When freezing soft fruits or berries, it is best to pre-freeze them for 1-2 hours or until solidly frozen. To freeze fruit in individual servings, first place on a baking sheet and spread them out so they are not touching. This prevents them from freezing together in a block. Once they are frozen, remove from baking sheet and vacuum seal fruit in a FoodSaver® Bag. After they have been vacuum sealed, return them to the freezer.

You can vacuum seal portions for baking, or in your favorite combinations for easy fruit salad all year round. If storing in the refrigerator, we recommend using a FoodSaver® Canister.





Preparation Guidelines for Make-ahead Meals, Leftovers and Sandwiches:

Efficiently store your make-ahead meals, leftovers and sandwiches in the stackable, lightweight FoodSaver® containers. They are microwaveable, top rack dishwasher safe and come with a custom adaptor. The lightweight containers will be ready to head off to the office, to school or the great outdoors whenever you are!

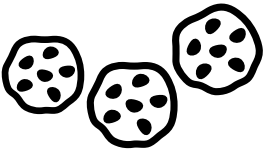

Preparation Guidelines for Snack Foods:

Your snack foods will maintain their freshness longer when you vacuum seal them. For best results, use a FoodSaver® Canister for crushable items like crackers.

Vacuum Sealing Non-Food Items

The FoodSaver® Vacuum Sealing System also protects non-food items from oxidation, corrosion and moisture. Simply follow the directions to vacuum seal items using FoodSaver® Bags, Canisters and Accessories.



- To vacuum seal silver, wrap fork tines in soft cushioning material, such as a paper towel, to avoid puncturing bag, and seal as normal. Your silver will be clean, fresh and untarnished right when you need it for your next dinner gathering.



- Your FoodSaver® Bags are ideal for outdoor excursions. For camping and hiking, keep your matches, maps and food dry and compact.



- To have fresh water for drinking, simply fill a FoodSaver® Bag with ice, vacuum seal it, and when needed, let the ice pack melt. You can trim the corner off the bag to make a spout for drinking or pouring.



- If you're going sailing or boating, you can vacuum seal your food, extra batteries, memory cards, cash, identification cards, boating license and a dry change of clothes. Just remember to bring scissors or a knife to open the bags when you need them!



- To keep emergency kits safe and dry, vacuum seal flares, batteries, flashlights, matches, candles, first aid kits, extra food and other necessities. Your emergency items will stay dry and organized in your home, car, boat or RV.

Care

and Cleaning of your Vacuum Sealer

To Clean Appliance:

Remove Power Cord from electrical outlet. Do not immerse in liquid.

Check Gaskets and around Drip Tray to make sure they are free from food materials. Wipe off Gasket with warm soapy cloth if needed. Upper and Lower Gaskets may be removed for cleaning. Clean with warm, soapy water.

The Removable Drip Tray makes cleanup easy when small amounts of liquids are inadvertently pulled into the Vacuum Channel during vacuum process.

Empty Drip Tray after each use. Wash in warm soapy water or place on top rack of dishwasher. Dry thoroughly before re-inserting into the appliance.

Always leave lid latch in STORE position. **Never store lid in OPERATE position as gaskets may become compressed.** When appliance is left in OPERATE position, the internal gaskets become compressed and the unit may not function properly (see below).

Remove all food around gaskets

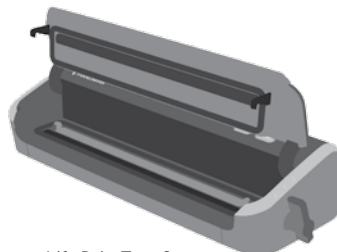

Lift Drip Tray Out

To Store Appliance:

Clean unit thoroughly as detailed above.

After the unit has been cleaned and allowed to fully dry, close lid and push the Easy Lock Latch into the STORE (middle) position. This setting will keep the lid closed but prevents any undue pressure from being applied to the internal sealing gaskets of the unit.

Always leave lid latch in STORE position when not in use. **Never store lid in OPERATE position as gaskets may become compressed.** When appliance is left in closed position, the Gaskets become compressed and the unit may not function properly.



Push the latch into the center position to store.

5-Year Limited Warranty

Sunbeam Products, Inc. doing business as Jarden Consumer Solutions or if in Canada, Sunbeam Corporation (Canada) Limited doing business as Jarden Consumer Solutions (collectively "JCS") warrants that for a period of five years from the date of purchase, this product will be free from defects in material and workmanship. JCS, at its option, will repair or replace this product or any component of the product found to be defective during the warranty period. Replacement will be made with a new or remanufactured product or component. If the product is no longer available, replacement may be made with a similar product of equal or greater value. This is your exclusive warranty. Do NOT attempt to repair or adjust any electrical or mechanical functions on this product. Doing so will void this warranty.

This warranty is valid for the original retail purchaser from the date of initial retail purchase and is not transferable. Keep the original sales receipt. Proof of purchase is required to obtain warranty performance. JCS dealers, service centers, or retail stores selling JCS products do not have the right to alter, modify or any way change the terms and conditions of this warranty.

This limited warranty does not cover normal wear of parts or damage resulting from any of the following: negligent use or misuse of the product, use on improper voltage or current, use contrary to the operating instructions, disassembly, repair or alteration by anyone other than JCS or an authorized JCS service center or use of this product with non-FoodSaver® branded bags and/or rolls. Further, this limited warranty does not cover: Acts of God, such as fire, flood, hurricanes and tornadoes.

What are the limits on JCS's Liability?

JCS shall not be liable for any incidental or consequential damages caused by the breach of any express, implied or statutory warranty or condition.

Except to the extent prohibited by applicable law, any implied warranty or condition of merchantability or fitness for a particular purpose is limited in duration to the duration of the above warranty.

JCS disclaims all other warranties, conditions or representations, express, implied, statutory or otherwise.

JCS shall not be liable for any damages of any kind resulting from the purchase, use or misuse of, or inability to use the product including incidental, special, consequential or similar damages or loss of profits, or for any breach of contract, fundamental or otherwise, or for any claim brought against purchaser by any other party.

Some provinces, states or jurisdictions do not allow the exclusion or limitation of incidental or consequential damages or limitations on how long an implied warranty lasts, so the above limitations or exclusion may not apply to you.

This warranty gives you specific legal rights, and you may also have other rights that vary from province to province, state to state or jurisdiction to jurisdiction.

How to Obtain Warranty Service

In the U.S.A.

If you have any question regarding this warranty or would like to obtain warranty service, please call 1.877.777.8042 and a convenient service center address will be provided to you.

In Canada

If you have any question regarding this warranty or would like to obtain warranty service, please call 1.877.804.5383 and a convenient service center address will be provided to you.

In the U.S.A., this warranty is offered by Sunbeam Products, Inc. doing business as Jarden Consumer Solutions located in Boca Raton, Florida 33431. In Canada, this warranty is offered by Sunbeam Corporation (Canada) Limited doing business as Jarden Consumer Solutions, located at 20 B Hereford Street, Brampton, Ontario L6Y 0M1. If you have any other problem or claim in connection with this product, please write our Consumer Service Department.

PLEASE DO NOT RETURN THIS PRODUCT TO ANY OF THESE ADDRESSES OR TO THE PLACE OF PURCHASE.

For inquiries regarding recycling and proper disposal of this product, please contact your local waste management facility.

Troubleshooting

Problem	Solution
Red Seal LED Flashing	<ul style="list-style-type: none"> • Unit is overheated. Always allow 20 seconds between seals. Under heavy usage, appliance will shut off automatically and Red Light will flash. Wait for 20 min. for unit to cool off. • Always wait 20 seconds between seals. • Latch has been left in OPERATE position: Gaskets may be compressed. Unlatch and allow 10 to 20 minutes for Gaskets to expand. • Vacuum pump running more than 120 seconds. Under heavy usage, appliance will shut off automatically and Red Light will flash. See next section Vacuum Pump is running, but bag is not evacuating.
Vacuum Pump is running, but bag is not evacuating	<ul style="list-style-type: none"> • If making a bag from a roll, make sure one end of bag is sealed. See How to Make a Bag from a FoodSaver® Vacuum Sealing Roll. • Adjust the bag and try again. Make sure the open end of the bag is down inside the vacuum channel. • Check for wrinkles in bag along Sealing Strip. To prevent wrinkles in the seal, gently stretch bag flat while inserting bag into Vacuum Channel. • Open unit and make sure Gaskets are inserted properly and there are no foreign objects, dirt or debris on the Upper or Lower Gasket (See Care and Cleaning). • Latch has been left in OPERATE position: Gaskets may be compressed. Unlatch and allow 10 to 20 minutes for Gaskets to expand. • Make sure the accessory hose is not attached to accessory port. • Make sure the lid is latched down all the way. If the Latch does not catch the lid and bring it down, there will be a leak between the Gaskets.
Gasket is loose or has a tear	<ul style="list-style-type: none"> • Take out the gasket, clean it and reinsert the Gasket into the Vacuum Channel (See Care and Cleaning). • Call 877-777-8042 or visit website for replacement.
Bag is not sealing properly	<ul style="list-style-type: none"> • Too much liquid in bag, freeze before vacuuming. • Check for food debris around seal area. If present, Take out the gasket, clean it and reinsert the Gasket into the Vacuum Channel (See Care and Cleaning). • Bag has wrinkles: To prevent wrinkles in the seal, gently stretch bag flat while inserting bag into Vacuum Channel.
No lights on the control panel	<ul style="list-style-type: none"> • Make sure unit is plugged in. • Make sure wall outlet is functional. • Make sure lid is all the way down, and the Latch is in the OPERATE position.

Troubleshooting (cont.)

Problem	Solution
Nothing happens when Latch is closed and Button is pressed	<ul style="list-style-type: none">• Make sure unit is plugged in.• Make sure wall outlet is functional.• Open Latch, make sure lid is all the way down, re-latch lid.
Cannot insert bag into machine	<ul style="list-style-type: none">• Make sure there is enough bag material to reach center of drip tray. Always allow three inches (7.62 mm) extra space to allow the bag to seal tightly around food contents.• Gently stretch bag flat while inserting. Insert bag CURL DOWN into Vacuum Channel.
Air was removed from the bag, but now air has re-entered	<ul style="list-style-type: none">• Examine the seal. A wrinkle along the seal may cause air to re-enter the bag. To prevent wrinkles in the seal, gently stretch bag flat while inserting bag into Vacuum Channel.• Sometimes moisture or food material (such as juices, grease, crumbs, powders, etc.) along seal prevents bag from sealing properly. Cut bag open, wipe top inside of bag and reseal.• Sharp food items may have punctured bag. Use a new bag if there is a hole. Cover sharp food items with a soft cushioning material, such as a paper towel, and reseal.• Fermentation or the release of natural gases from inside the foods may have occurred. When this happens, food may have begun to spoil and should be discarded.
Bag melts	<ul style="list-style-type: none">• Sealing Strip may have become too hot. Always wait at least 20 seconds for appliance to cool down before you vacuum seal another item.• Use FoodSaver® brand bags. Our FoodSaver® Bags and Rolls are specially designed for FoodSaver® units.
If you need further assistance:	<ul style="list-style-type: none">• Call Consumer Services at 1-877-777-8042.• For additional tips and answers to frequently asked questions, go to www.foodsaver.com and click the “Service & Support” tab.
Container does not vacuum	<ul style="list-style-type: none">• The lid of the container must be correctly placed on and aligned to the container• Assure the green end of the accessory cable marked TO SEALER is pushed into the unit until you hear it “click”• Firmly press the remaining grey end marked TO ACCESSORY into the container• Assure side handle is turned to OPERATE• Press the Vacuum and Seal button

Storage Guide: Meat, Cheese, Vegetables, Fruits

Foods	Where to Store	Recommended FoodSaver® Bag/Accessory	Storage Life with FoodSaver® Bag/Accessory	Normal Storage Life
Meat				
Beef, Pork, Lamb	Freezer	FoodSaver® Bag	2-3 years	6 months
Ground Meat	Freezer	FoodSaver® Bag	1 year	4 months
Poultry	Freezer	FoodSaver® Bag	2-3 years	6 months
Fish	Freezer	FoodSaver® Bag	2 years	6 months
Hard Cheeses (Do not vacuum seal soft cheese)				
Cheddar, Swiss	Refrigerator	FoodSaver® Bag, Canister	4-8 months	1-2 weeks
Parmesan	Refrigerator	FoodSaver® Bag, Canister	4-8 months	1-2 weeks
Vegetables (Do not vacuum seal fresh mushrooms, onions & garlic)				
Asparagus	Freezer	FoodSaver® Bag	2-3 years	8 months
Broccoli, Cauliflower	Freezer	FoodSaver® Bag	2-3 years	8 months
Cabbage, Brussels Sprouts	Freezer	FoodSaver® Bag	2-3 years	8 months
Corn (cob or kernel)	Freezer	FoodSaver® Bag	2-3 years	8 months
Green Beans	Freezer	FoodSaver® Bag	2-3 years	8 months
Lettuce, Spinach	Refrigerator	FoodSaver® Canister	2 weeks	3-6 days
Snow Peas, Snap Peas	Freezer	FoodSaver® Bag	2-3 years	8 months
Fruits				
Apricots, Plums	Freezer	FoodSaver® Bag	1-3 years	6-12 months
Peaches, Nectarines	Freezer	FoodSaver® Bag	1-3 years	6-12 months
Softer Berries				
Raspberries, Blackberries	Refrigerator	FoodSaver® Canister	1 week	1-3 days
Strawberries	Refrigerator	FoodSaver® Canister	1 week	1-3 days
Harder Berries				
Blueberries	Refrigerator	FoodSaver® Canister	2 weeks	3-6 days
Cranberries	Refrigerator	FoodSaver® Canister	2 weeks	3-6 days
Huckleberries	Refrigerator	FoodSaver® Canister	2 weeks	3-6 days

Storage Guide: Baked Goods, Coffee, Snacks and Liquids

Foods	Where to Store	Recommended FoodSaver® Bag/Accessory	Storage life with FoodSaver® Bag/Accessory	Normal Storage Life
Baked Goods				
Bagels, Bread, Pastries	Freezer	FoodSaver® Bag	1-3 years	6-12 months
Nuts				
Almonds, Peanuts	Pantry	FoodSaver® Bag, Canister	2 years	6 months
Sunflower Seeds	Pantry	FoodSaver® Bag, Canister	2 years	6 months
Coffee				
Coffee Beans	Freezer	FoodSaver® Bag	2-3 years	6 months
Coffee Beans	Pantry	FoodSaver® Bag, Canister	1 year	3 months
Ground Coffee	Freezer	FoodSaver® Bag	2 years	6 months
Ground Coffee	Pantry	FoodSaver® Bag, Canister	5-6 months	1 month
Prepared Liquids				
Sauces, Soups, Stews	Freezer	FoodSaver® Bag	1-2 years	3-6 months
Bottled Liquids				
Oils	Pantry	FoodSaver® Bottle Stopper	1-1 1/2 years	5-6 months
Dry Foods				
Beans, Grains	Pantry	FoodSaver® Bag, Canister	1-2 years	6 months
Pasta, Rice	Pantry	FoodSaver® Bag, Canister	1-2 years	6 months
Powdery Foods				
Dry Milk	Pantry	FoodSaver® Bag, Canister	1-2 years	6 months
Dried Coconut	Pantry	FoodSaver® Bag, Canister	1-2 years	6 months
Flour	Pantry	FoodSaver® Bag, Canister	1-2 years	6 months
Sugar, Brown Sugar	Pantry	FoodSaver® Bag, Canister	1-2 years	6 months
Snack Foods				
Chips	Pantry	FoodSaver® Canister	3-6 weeks	1-2 weeks
Cookies, Crackers	Pantry	FoodSaver® Canister	3-6 weeks	1-2 weeks

Notes

NOTES

Notes

NOTES