

**NOTE: Order parts by Catalog Number only.  
DO NOT order by Reference Number.**

Ref. No.	Catalog No.	Description	Ref. No.	Catalog No.	Description
1	24483	Handle Pad	25	24548	Tube Seal
2	24488	Screw #4-20 x 1/2"	26	24683	SR-20 Product Decal
3	24418	Speaker Gasket	34803	34803	Scout Icon Ref. Label
4	24493	Speaker	27	24278	SR-20 Icon Ref. Label
5	24498	Speaker Adhesive Label	28	34813	Scout Product Label
6	24503	Speaker Circuit Board	29	24553	Screw #4-20 x 3/8"
7	24508	Flat Washer	30	24558	SR-20 Display Window
8	24513	Cross Pin	31	34818	Scout Display Window
9	21343	Keypad	32	23643	SR-20 LCD
10	24518	SR-20 Top Case Asm	33013	33013	Scout LCD
	32998	Scout Top Case Asm	31	23638	SR-20 LCD Mounting Plate
11	24298	Top Handle Seal	32	23653	SR-20 LCD Power Module
12	24523	Foam, 2" Wide Sheet	33	23658	SR-20 LCD Gasket
13	24528	Tape, 2.25" Wide Backing	34	34823	Scout LCD Gasket
14	24383	Screw #4-40 x 3/8"	34	33008	Scout Main Circuit Board
15	24533	Hex Nut #4-40			
16	24273	Housing Seal	<b>Following Items Not Shown</b>		
17	24293	Bottom Handle Seal	—	24563	Serial Board Asm
18	24433	SR-20 Bottom Case Asm	—	24568	USB/Serial Port Cover
	33003	Scout Bottom Case Asm	—	24388	Bottom Handle Grip Pad
19	24303	Nylon Washer	—	31923	Flex Cable
20	24288	Screw #6 x 5/8"	<b>These Parts Are Located Inside Bottom Case</b>		
21	27868	Battery Cover	—	24583	Right Angle Mounting Bracket
22	24368	Screw #6 x 3/4"	—	24588	Screw #6 x 3/8"
23	24538	Tube Bracket	—	24593	Screw #6-32 x 3/16"
24	24543	Tube Bracket Gasket			

**NOTE: Parts Are Identical Between SR-20 & Scout Locators Unless Specifically Noted.**

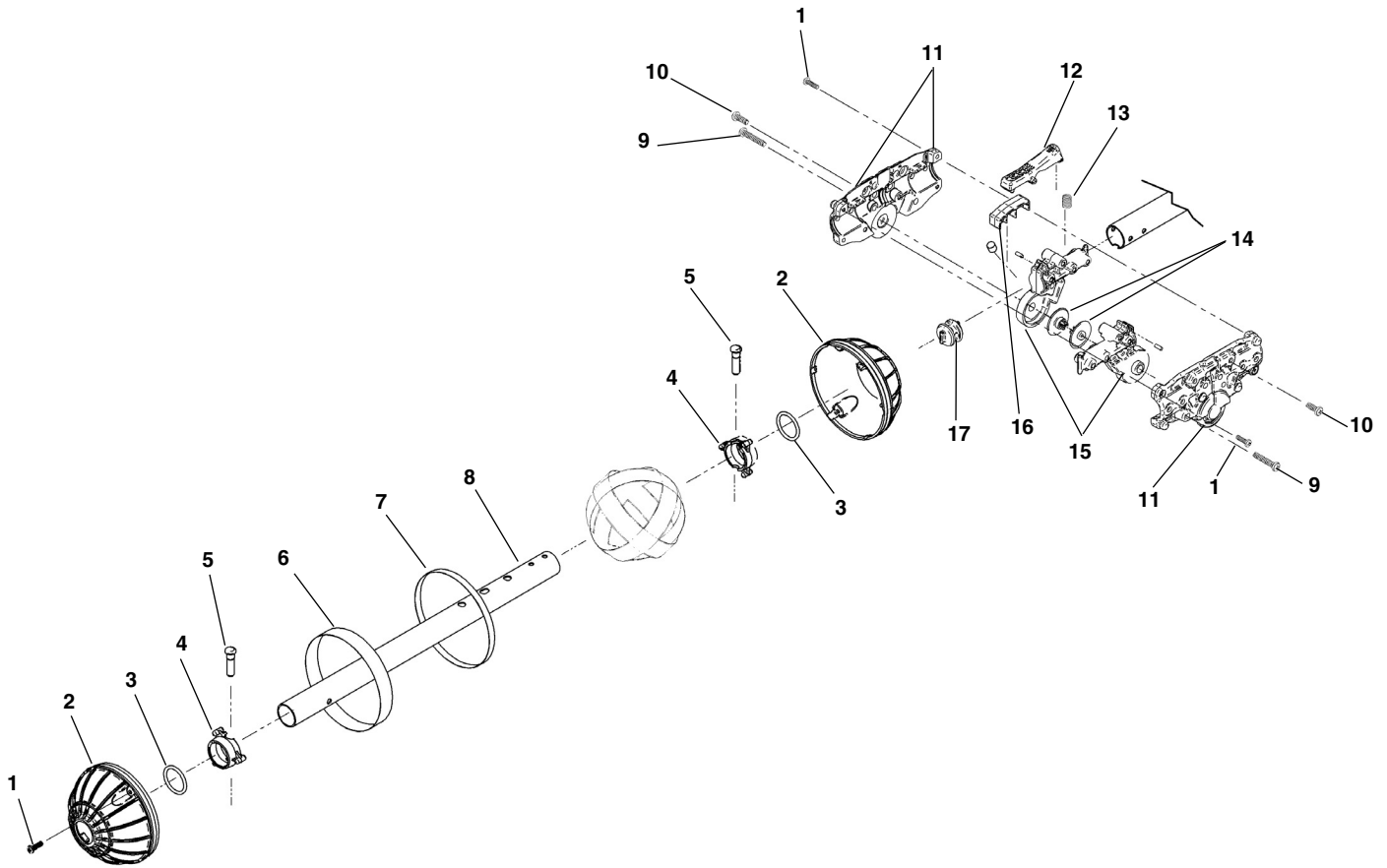

**NOTE: Order parts by Catalog Number only.  
DO NOT order by Reference Number.**

Ref. No.	Catalog No.	Description
1	24413	Screw #6 x 1/2"
2	24328	Top Antenna Shell
3	24358	O-Ring
4	24318	Antenna Pin Ring
5	24373	Pin
6	24313	Antenna Ball Label
7	24363	Double Sided Tape Roll
8	24378	Top Tube
9	24408	Screw #8 x 1"
10	24403	Screw #8 x 1/2"
11	23663	Outer Pivot Asm
12	23593	Pivot Latch
13	23603	Latch Spring
14	23598	Wire Reel
15	23588	Center Pivot
16	23628	Rear Pivot Cover
17	23613	Seal

**NOTE: Parts Are Identical Between SR-20 & Scout Locators Unless Specifically Noted.**

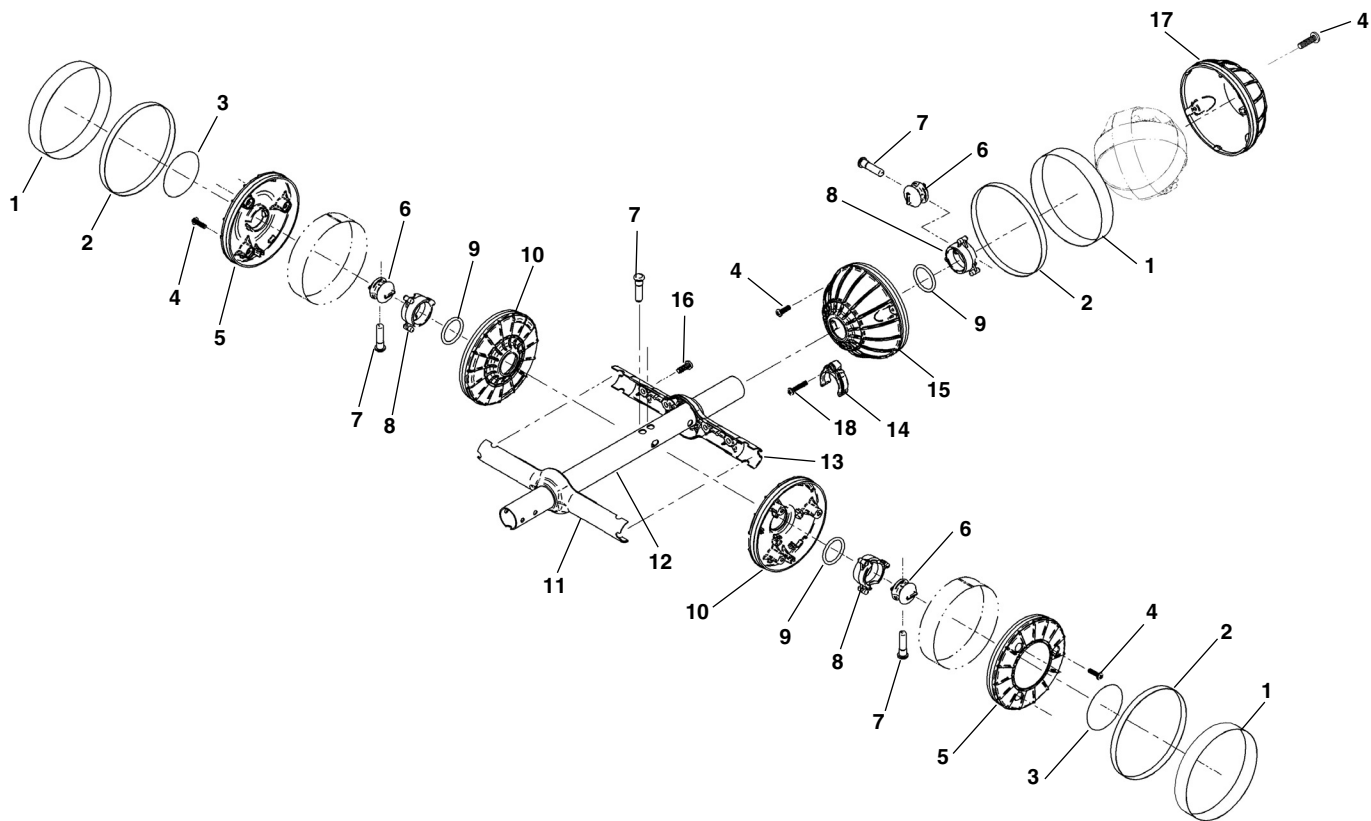

**NOTE: Order parts by Catalog Number only.  
DO NOT order by Reference Number.**

Ref. No.	Catalog No.	Description
1	24313	Antenna Ball Label (SR-20)
	34858	Antenna Ball Label (Scout)
2	24363	Double Sided Tape Roll
3	24478	Side Antenna Label (SR-20)
4	24413	Screw #6 x 1/2"
5	24343	Gradient Antenna Shell (Outer) (SR-20)
6	23613	Seal
7	24373	Rivet
8	24318	Antenna Pin Ring
9	24358	O-Ring
10	24348	Gradient Antenna Shell (Inner) (SR-20)
11	24353	Top Tube Bracket (SR-20)
12	24308	Bottom Tube
13	24338	Bottom Tube Bracket (SR-20)
14	24333	Tube Lock
15	24328	Top Antenna Shell
16	24403	Screw #8 x 1/2"
17	24323	Bottom Antenna Shell
18	24368	Screw #6 x 3/4"
<b>Following Items Not Shown</b>		
	34863	Peg Chip Holder

**NOTE: Parts Are Identical Between SR-20 & Scout Locators Unless Specifically Noted.**