

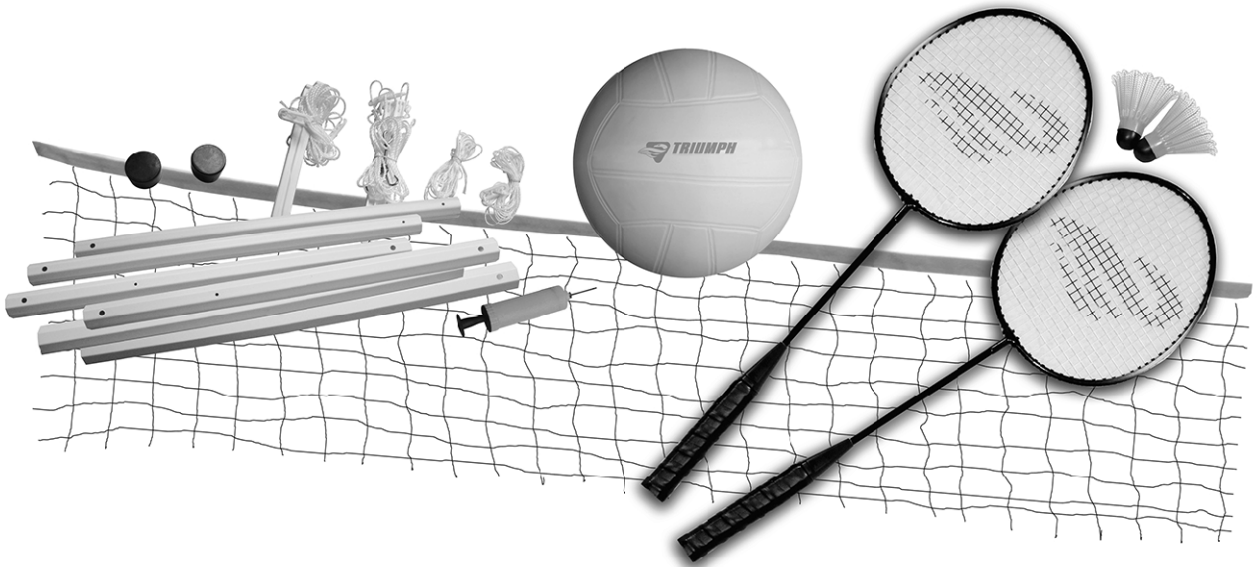

TRIUMPH

VOLLEYBALL BADMINTON COMBO SET INSTRUCTION MANUAL



PLEASE KEEP THIS INSTRUCTION MANUAL FOR FUTURE REFERENCE

If you have any concerns with your product please visit our website www.escaladesports.com for fastest service. Please have a copy of your receipt of purchase. For any technical support or warranty issues please contact Escalade Sports at 1-800-467-1421 or e-mail us at customerservice@escaladesports.com

Limited 90-Day Escalade Sports Warranty

All Escalade Sports games have a limited 90-day from date of purchase warranty. This warrants the retail purchaser for any Escalade Sports game purchased to be free from any defect in materials and construction for 90 days from the date of purchase. The only exceptions to the warranty include main frames, tabletops, playing surfaces, batteries or tools. Damaged main frames, tabletops, playing surfaces need to be returned to the store as we are unable to replace these parts. Normal play wear and usage is not covered under the warranty, nor is wear or damage due to improper use of the Escalade Sports game. This will void any and all Escalade Sports warranties.

A PURCHASE RECEIPT (or other proof of purchase date) will be required before any warranty service is initiated. All requests for warranty service can be submitted by email, in writing or by contacting our Customer Service Department at: 1-800-467-1421 or email us at customerservice@escaladesports.com

IMPORTANT NOTICE! Please contact us before returning the product to the store.

Warnings



Not for use by children without adult supervision. This is not a child's toy. Adult supervision is required for children playing this game. Please read instructions carefully.

Be sure to check out all the exciting a games has to offer. Visit our web site at:



www.escaladesports.com



BILLIARDS



DARTS



GAME TABLES



CASINO



OUTDOOR GAMES











DARTBOARDS

Escalade Sports
817 Maxwell Avenue
Evansville, IN 47711
1-800-467-1421

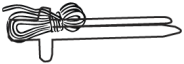
©2019 copyright Escalade Sports®
all rights reserved.

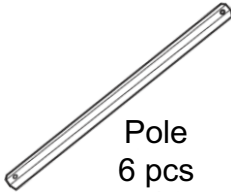
Parts List

1	2	3	4	5
 <p>Volleyball 1 pc</p>	 <p>Net 1 pc</p>	 <p>Badminton racket 2 pcs</p>	 <p>Shuttlecock 2 pcs</p>	 <p>Bottom guide rope 2 pcs</p>
6	7	8	9	10
 <p>Top guide rope 2 pc</p>	 <p>Plastic pole cap 2 pcs</p>	 <p>Pole 6 pcs</p>	 <p>Inflating pump with needle 1 pc</p>	

Assembly Instructions

Step 1

Insert ropes on top and bottom corners of net through top and bottom holes of top pole and secure with knots. See detail A and B.

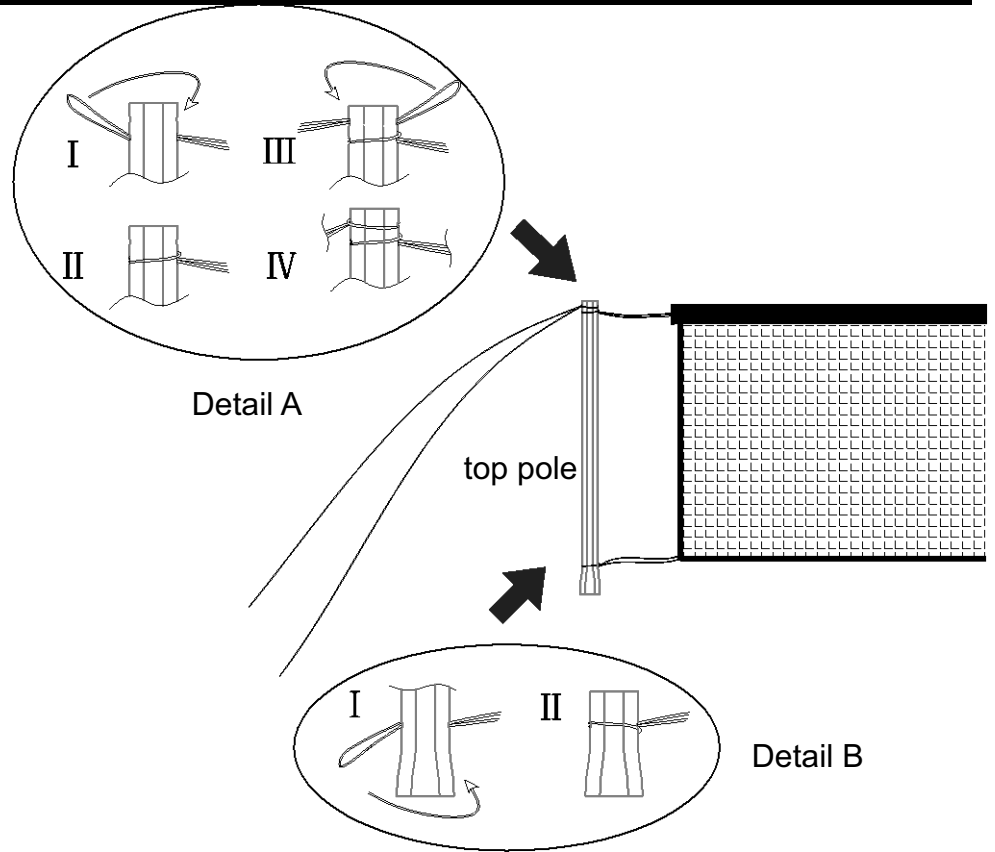

Step 2:

Attach the middle pole section into the top pole by aligning the holes.

Insert lower guide rope loop through hole in middle pole.

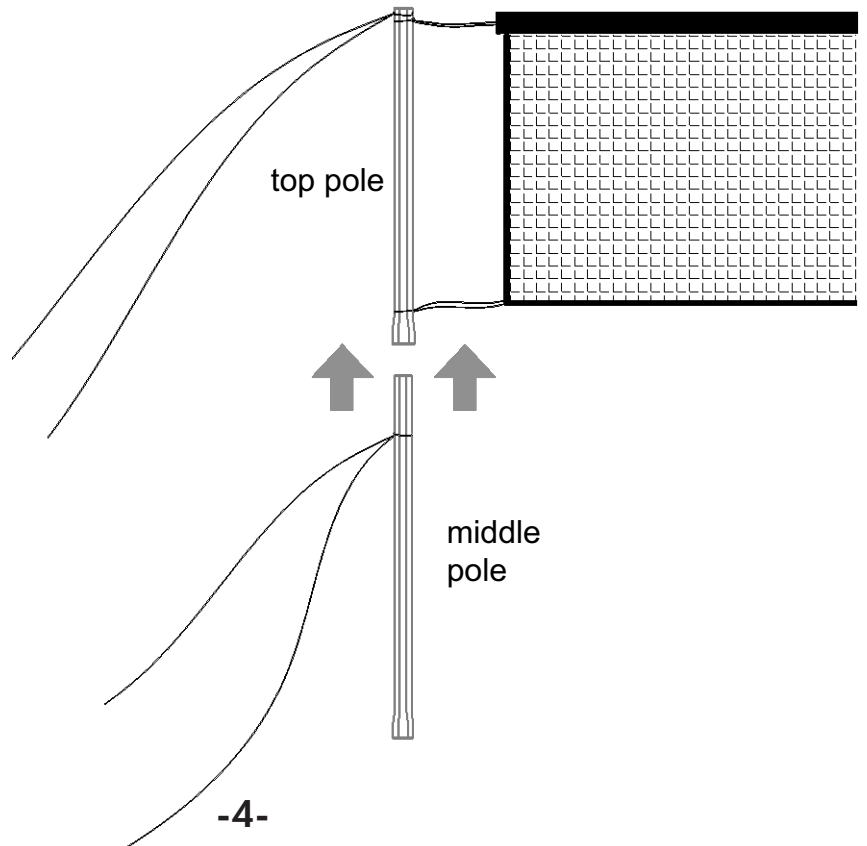

Assembly Instructions

Step 3:

Insert the bottom pole section into the middle pole by aligning the holes.

Place the plastic cap on top of the pole.

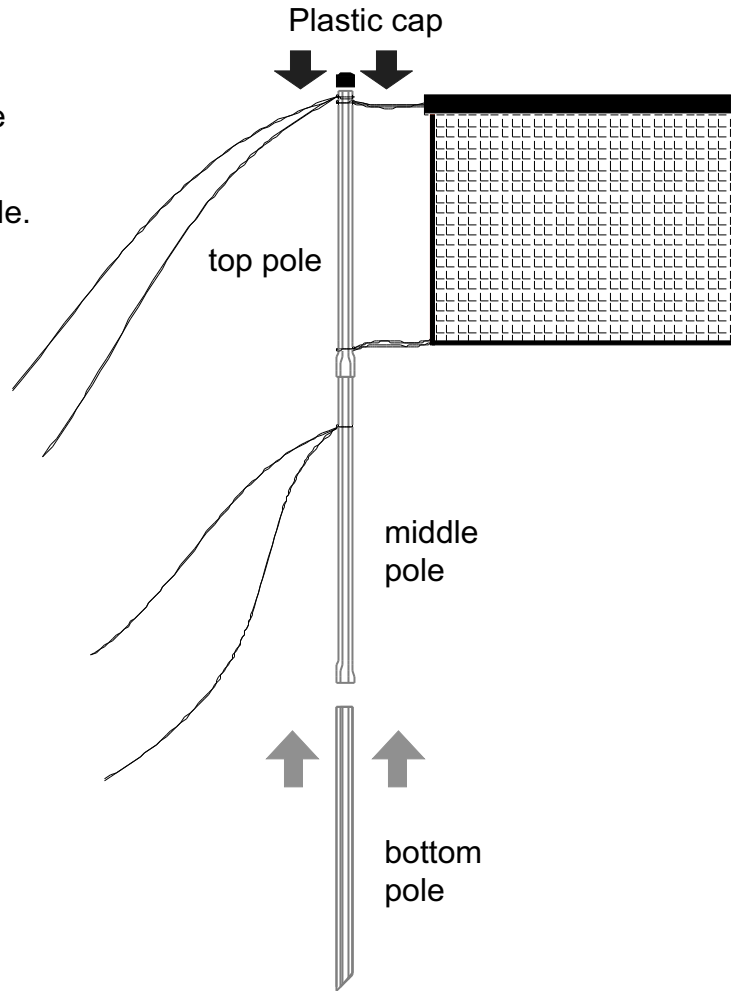

Step 4:

Stretch assembled net and poles across playing area until net is tight. Press pole into ground. Holding poles in vertical position, press **upper guide rope stakes** into ground at 45 degree angle, 3 feet to 5 feet from pole and 3 feet to 5 feet apart. Loop the **lower guide ropes** over the **stakes** and adjust rope **tensioners** until the ropes are taut.

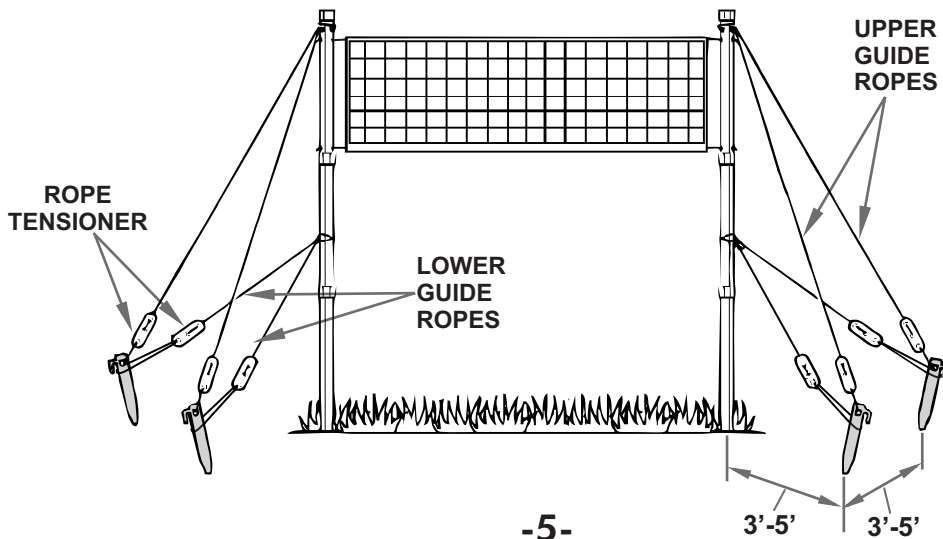

Volleyball Rules

Court Size

Standard size of court is 30 feet wide and 60 feet long. Width and length can be increased or decreased proportionately depending on the area available.

Net

The net shall be stretched across the center of the court dividing it in half. The net height can vary from the official 8 feet height to other popular heights such as 7 feet or 5 feet or any desired height.

Player

6 players on each team.

Service

Each player shall serve in turn and will continue to serve until side is out. When serving, the ball must go over the net. If the ball hits the net when served and goes over the net, the ball must be re-served. If the ball does not go over the net when served or is out of bounds or touches any team-mate before touching an opponent or opponent's court, the side is out and the opponent takes possession and becomes the serving team.

Service Area

The service area should be a minimum of 5 feet in depth behind the end boundary court and in the event the playing area does not provide space for such depth, then the serving area shall extend into the court to whatever distance is necessary to provide such a minimum service area. The service area should be located in the right end section of each court, the width not to exceed 8 feet.

Volley

Maximum of three team contacts: each team is allowed a maximum of 3 successive contacts of the ball in order to return the ball to the opponent's area.

Rotation

After a team has lost its serve, the team receiving the ball for the first serve shall, before serving, rotate one position clockwise.

Volleyball Rules

Errors

When a player and/or when the ball is in play:

1. Does not clearly hit the ball or allows the ball to come to rest in any part or parts of the body.
2. Hits the ball out of the boundaries of the court.
3. Allows the ball to hit the floor, or any object outside of the court (except net), before being legally returned to the opponent's court.
4. Touches the ball twice in succession.
5. Fails to make a good serve.

Fouls

1. Holding the ball or throwing it.
2. If the ball touches any part of the body, except the hands or forearms.
3. Touching the net with any part of the body or hands, or reaching over the net.
4. If a player plays out of position when ball is being served.

Scoring

Only the serving team can score. When the serving team fails to score, it is "side out" and the receiving team becomes the serving team.

Penalty

The penalty for fouls or errors committed shall be "point" or "side out", as the case may be.

Game

The game shall be played to 21 points, or the teams may agree to play to 15 points. A match consists of three games. The match winner is the team to win two out of three games.

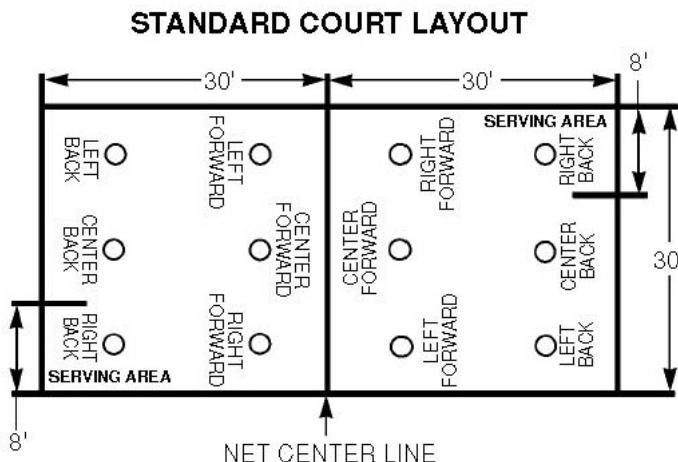

Caution: Stand clear of the court area to avoid being injured while a player is taking his or her turn.

Badminton Rules

Court Size

Standard size court is 20 feet wide and 44 feet long. The length and width however can be increased or decreased proportionately depending on the area available.

Net

The net shall be stretched across the center of the court dividing it in half. The net height should be 5 feet in the center of the net to 5 feet 1 inch at the poles.

Player

In doubles the game is played by two players per side. In singles the game is played by one player per side.

Service

The team winning the toss of the coin shall have the option of serving first, receiving the serve or choosing the court end. The side that serves first has only one serve to start the game. After the game begins each team gets two serves.

Service Rotation

The team which serves first must serve from their right half court diagonally opposite to their opponents right half court.

In Doubles: The serve must alternate from the right half court to left half court after each serve, so no player on the opposing team receives two consecutive serves. Teammates must serve consecutively.

In Singles: The players serve from the right half court when their score is "0" or an even number of points. Service is delivered from left half court on odd number points. If the team serving makes a fault, one serve is lost. If the team receiving the serve makes a fault, the team serving gets a point and continues the serve. The serve must alternate from right and left half courts after each serve as stated before.

Badminton Rules

The Game

The game can be played to 15 or 21 points. The best two out of three games wins the match. Teams shall change court ends after each game.

Faults

- If the shuttle is served overhand. The shuttle must be struck at a point not higher than the servers waist.
- If in serving, the shuttle falls into the wrong service court or falls short of the service line or beyond the long service line or outside the side boundary lines.
- If the server or person receiving the service does not serve from within their right or left half court, whichever the case may be.
- If the server or player intentionally distracts, balks or obstructs his opponent.
- If the server in attempting to serve, misses the shuttle.
- If during service or play the shuttle falls outside the boundaries of the court, passes through or under the net or fails to pass over the net.
- If a player reaches over the net and hits the shuttle on their opponents side of the court. However a player may hit the shuttle on their side of the court and follow through on the swing over the net.
- If the shuttle is hit twice in succession by the same player or the shuttle is hit by a player and his teammate successively.

NOTE: It is not a fault if the shuttle hits the net during service or play and goes over the net. If this occurs during the serve it is just re-served.

