

OXO

GOOD GRIPS®

**COLD BREW
COFFEE MAKER**

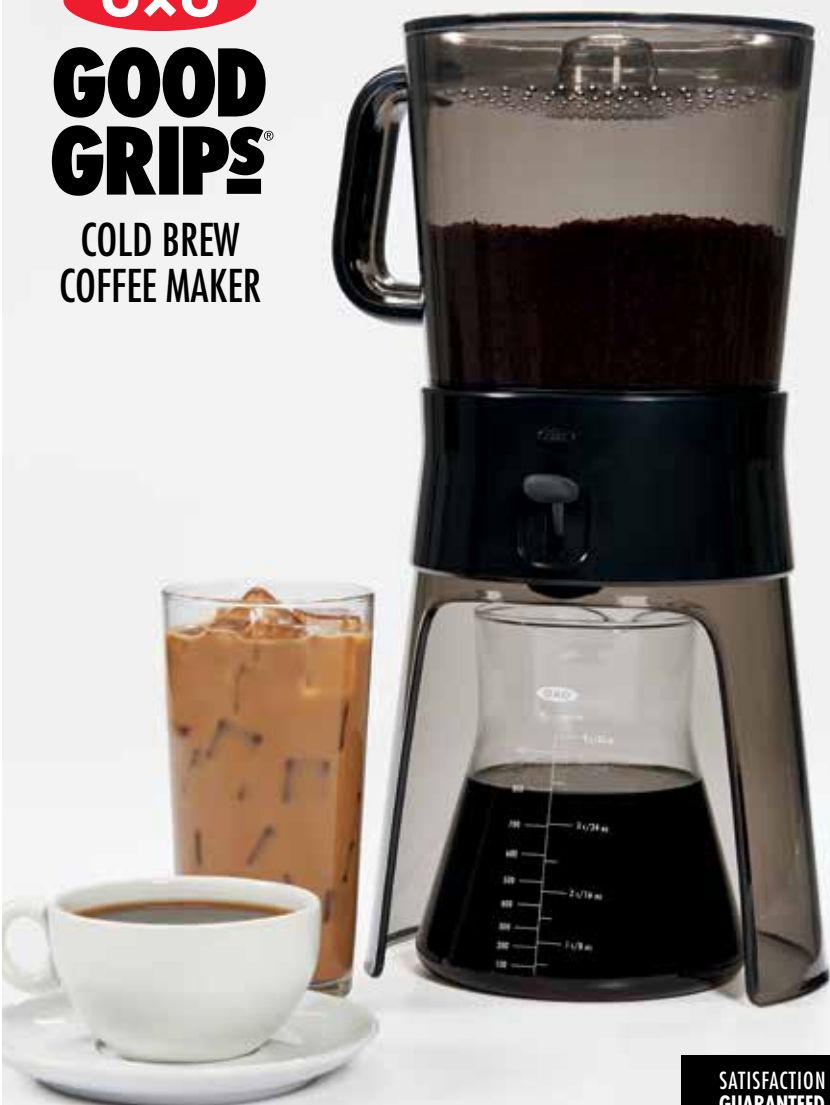

**SATISFACTION
GUARANTEED**

OXO is dedicated to providing innovative consumer products that make everyday living easier.

How do we do it?

We study people — lefties and righties, male and female, young and old — interacting with products and identify ways to make them better. Our “question everything” process and relentless attention to detail uncover the best solutions for slicing, peeling, whisking, baking, stirring, washing, scrubbing, dusting, storing and organizing.



TABLE OF CONTENTS

Introduction	pg 2
Product Features	pg 3
Getting Started	pg 4
Use & Care	pg 7
Tips	pg 8
Notes	pg 11

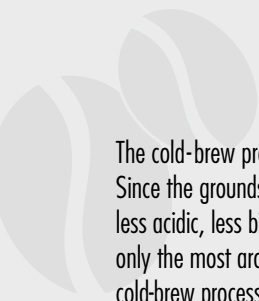

The cold-brew process is known for delivering smooth, low-acid coffee. Since the grounds never come in contact with hot water, the result is a less acidic, less bitter flavor. Steeping the grounds in cold water releases only the most aromatic flavors, and the concentrate created from the cold-brew process stays fresh longer than regular coffee.

Our Cold Brew Coffee Maker simplifies the cold brew process with its unique features. For example, the Rainmaker™ ensures water is distributed evenly over coffee grounds, the Brew-Release Switch is easily accessible and allows you to stop and start the draining process, and the stainless steel, ultra-fine mesh filter is removable for easy cleaning. The Coffee Maker has all the hard work covered – all you have to do is add coffee grounds and water. Once you make the concentrate, you can add ice and water for iced coffee or hot water and milk for hot coffee.



Tea-lover? You can use the same process to cold brew tea! With a flick of a switch, our stainless steel filter strains your favorite tea into a sealable, glass carafe.

PRODUCT FEATURES



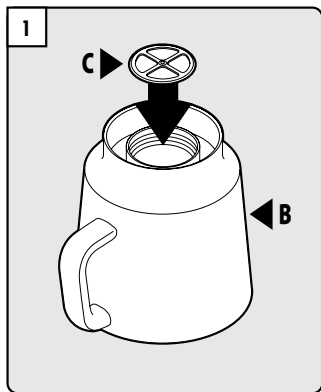
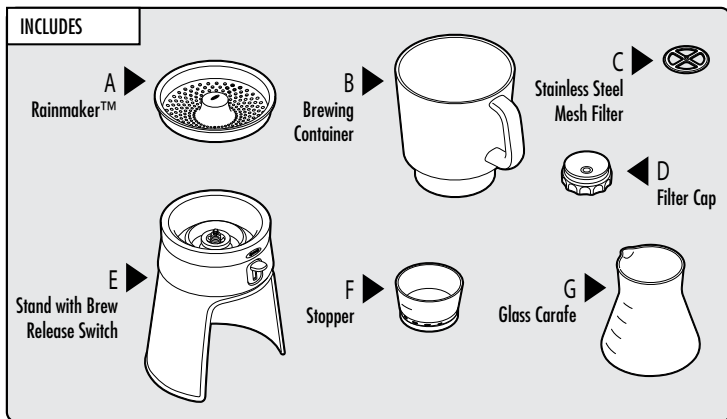

Flip Brewing Container (B) upside down. Set Mesh Filter (C) in either direction so that it sits flat in base.

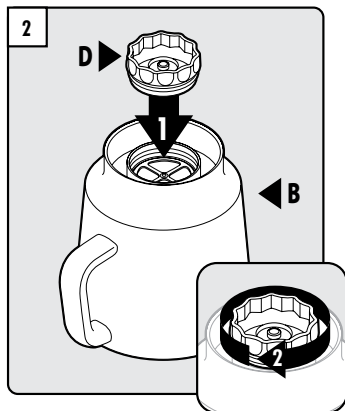

Screw on Filter Cap (D) until secure.

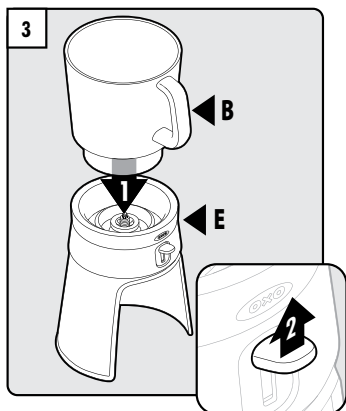

Place Brewing Container on Stand (E). Brew-Release Switch on Stand should be in the up (off) position.

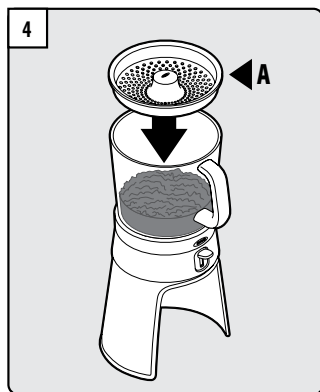

Add 10 oz/284 g* coarsely ground coffee to Brewing Container. Place Rainmaker™ (A) on top.
*We recommend weighing your coffee, but 10 oz is roughly 3.5 cups.



Pour 40 oz/1200 ml (5 cups) of water over Rainmaker in a circular motion, to ensure even distribution. If coffee is freshly ground, allow coffee to finish “blooming” (See Note). Remove Rainmaker and gently stir grounds. Brew 12-24 hours.

RECOMMENDED RECIPE

GROUND COFFEE	TOTAL WATER	YIELD
10 oz 284 g max (Approx 3.5 cups)	40 oz 1200 ml (5 cups)	24-28 oz 700-800 ml (3-3.5 cups) of coffee concentrate, or 12-14 beverages

To produce less coffee, we still recommend using a 1:4 coffee to water ratio.

Note: Adding water to freshly ground coffee causes grounds to expand and bubble, known as “blooming.” This is due to the rapid release of carbon dioxide. Blooming must finish before grounds can fully saturate with water and begin to brew. Very freshly roasted and ground coffee may bloom for up to 10 minutes.

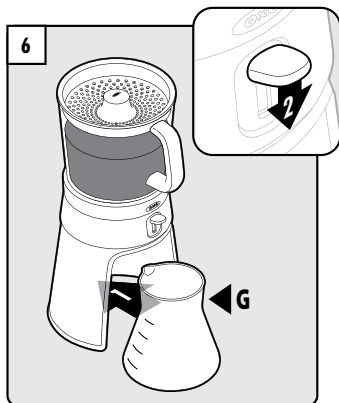

Once brewing is finished, slide Glass Carafe (G) underneath Stand. Press Brew-Release Switch down to drain. Draining will take approximately 20 minutes, but could vary based on ground size.

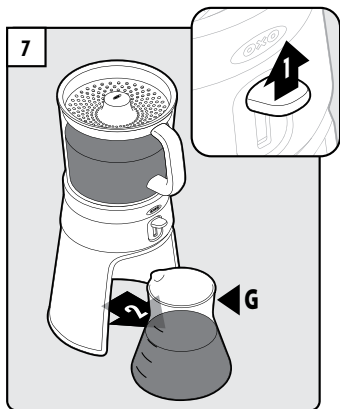

To enjoy concentrate before draining is complete, pull out Glass Carafe or flip up Brew-Release Switch to stop drip. To restart draining, reposition Glass Carafe and press down Switch.

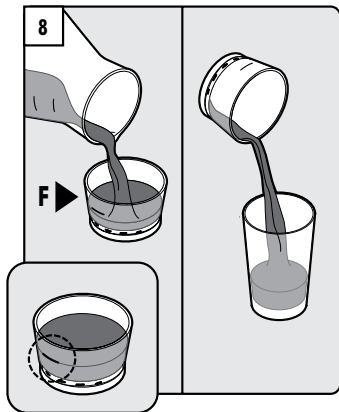

To serve, measure out 2 oz/60 ml ($\frac{1}{4}$ cup) of concentrate using the line on the Stopper (F). Dilute with water, milk or ice (refer to chart). Use Stopper to seal Glass Carafe, and store in the refrigerator, for up to two weeks.

TO DILUTE & SERVE

For One Serving: Pour 2 oz/60 ml ($\frac{1}{4}$ cup) concentrate	Iced Coffee: Add 4-6 oz/120-180 ml ($\frac{1}{2}$ - $\frac{3}{4}$ cup) cold water or milk, plus ice
	Hot Coffee: Add 4-6 oz/120-180 ml ($\frac{1}{2}$ - $\frac{3}{4}$ cup) hot water or milk

YIELD



YIELD: Using 10 oz/284 g of coffee and 40 oz/1200 ml (5 cups) of water, one carafe of concentrate produces roughly 12-14 beverages.

USE & CARE

Glass carafe is dishwasher safe
Hand wash all other parts

Note: If you remove the gasket in the Filter Cap (D) to clean, ensure the gasket is not twisted when reassembled to prevent leaking.

TO STORE

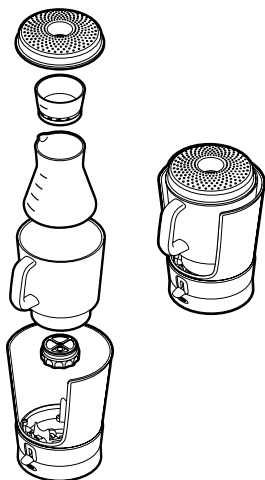

TIPS FOR ENJOYING YOUR COLD BREW

Making Your Coffee Concentrate

Acidity

Many variables contribute to the acidity level of coffee — including where the bean is grown, how it is harvested and how it is roasted; however, the same coffee bean cold brewed produces a coffee with much less acidity than if it were brewed with hot water. Cold water simply extracts less acid from the bean.

Roast

We've noticed that lighter roasts bring out some nice fruity flavors inherent within the beans, but any roast will do. We encourage you to experiment to figure out which you like best.

Grind Size

Medium to coarse ground coffee works best with the OXO Cold Brew Coffee Maker. Look for the "Automatic Drip" or "French Press" setting on grinders.

Recipe

We recommend a 1:4 coffee to water ratio. 10 oz/284 g of coffee* to 40 oz/1200 ml (5 cups) of water fits perfectly in the OXO Cold Brew Coffee Maker. Adjusting this ratio will result in a stronger or weaker concentrate, which you may prefer.

*We recommend weighing your coffee since volume can vary depending on grind size, roast, etc. If you don't have a scale, 10 oz/284 g of coffee is roughly 3.5 cups.

Brew Time

Think of cold brewing coffee as replacing heat with time. To fully extract flavors, coffee should steep 12-24 hours (or overnight). Good things come to those who wait!

Filtration Time

Using coarse ground coffee, filtration can take around 20 minutes. A finer ground will filter much more slowly. For instance, an espresso grind may take as long as 45 minutes to an hour to filter.

Making Your Coffee Beverage

Servings

We recommend a 1:2 or 1:3 ratio of coffee concentrate to water or milk. For example, if you measure out 2 oz/60 ml of concentrate using the line on the Stopper, you would dilute it with 4-6 oz/120-180 ml of water or milk. Keep in mind that adding ice will further dilute your beverage. Our 10 oz/284 g of coffee recipe yields about 12-14 beverages.

Hot Coffee

If you prefer your coffee hot, simply add 4-6 oz/120-180 ml of hot water or milk to your 2 oz/60 ml of concentrate.

Sweet Cold Brew

Granulated sugar is difficult to dissolve in a cold beverage; to sweeten your drink, we recommend simple syrup. To make, simply dissolve 1 part sugar in 1 part hot water.

Good Tip

Try making New Orleans Style cold brew by adding roasted chicory to your grounds as they brew, or try other infusions, including using cinnamon, clove or orange peels. Since the cold brew concentrate packs a lot of flavor, it is also ideal for recipes, such as brownies and coffee flavored ice cream. For more ideas and recipes, check out www.oxo.com.



TIPS FOR ENJOYING YOUR COLD BREW

Making Your Tea Concentrate

Recipe

Teas come in many varieties, from white to green to black, herbal, rooibos, bagged and loose leaf. As a jumping off point, we recommend trying 16 g of loose leaf tea, or 8 tea bags, with 32 oz/950 ml cold water. The weight of the tea will vary by type, so if you lack a scale, try using 1-2 teaspoons of loose leaf tea per cup of water. Keep in mind the capacity of our Glass Carafe when sealed is 32 oz/4 cups, so be careful not to overflow. The intensity and flavor of the concentrate will ultimately depend upon the kind of tea, ratio of tea leaves to water, and brew time. We advise you experiment to discover your perfect beverage!

Tea Type

You can use any tea you normally prefer drinking! We only advise against finely ground or powdered teas, like matcha, which may inhibit filtration.

Bagged vs. Loose Leaf

Both bagged and loose leaf teas work. Tea bags often contain finer leaf particles than loose leaf teas. Keep in mind that particle size, as well as type of tea, are factors that influence extraction rate and flavor.

Brew Time

We recommend cold brewing your tea between 5-12 hours. Shorter brew times will more likely produce a weaker tea, which you can drink straight or over ice. Longer brew times may cause your tea to become more concentrated; however, be aware, some kinds of tea leaves, like green tea, can become bitter if left to brew too long.

To Serve

Depending on the strength, you may want to dilute your tea with water, milk, or ice.





SATISFACTION GUARANTEE

OXO guarantees everything we make!

If for any reason you are not satisfied with your OXO Good Grips Cold Brew Coffee Maker, return it for replacement or refund.

For consumer service questions, please visit www.oxo.com or contact OXO Consumer Services at (800)545-4411. Customers outside of the U.S. can find their local distributor's contact information on the International Inquiries page at www.oxo.com