

# ILLUMINATIONS™ COLOR BLAST™

REMOTE CONTROLLED LED LIGHTS

## LOLLIPOP PATHWAY MARKER LED LIGHTS

**READ, AND KEEP THESE INSTRUCTIONS FOR FUTURE REFERENCE**

FAILURE TO FOLLOW THESE WARNINGS AND INSTRUCTIONS CAN RESULT IN SERIOUS INJURY OR DEATH TO USERS, ESPECIALLY CHILDREN.

### **⚠ WARNING**

### **IMPORTANT SAFETY INSTRUCTIONS**

When using electrical products, basic precautions should always be followed including the following:

1. **READ AND FOLLOW ALL SAFETY INSTRUCTIONS.**
2. Do not use seasonal products outdoors unless marked suitable for indoor and outdoor use. When used outdoors, this product must be connected to a Ground Fault Circuit Interrupting (GFCI) outlet. If one is not provided, contact a qualified electrician for proper installation.
3. This seasonal use product is not intended for permanent installation or use.
4. Do not mount or place near gas or electric heaters, fireplace, candles or other similar source of heat.
5. Do not secure the wiring of the product with staples or nails, or place on sharp hooks or nails.
6. Do not let lamps rest on the supply cord or on any wire.
7. Unplug the product when leaving the house, or when retiring for the night, or if left unattended.
8. This is an electric product - not a toy! To avoid risk of fire, burns, personal injury and electric shock, it should not be played or placed where small children can reach it.
9. Do not use this product for other than its intended use.
10. Do not hang ornaments or other objects from cord, wire, or light string.
11. Do not close doors or windows on the product or extension cords as this may damage the wire insulation.
12. Do not cover the product with cloth, paper or any materials not part of the product when in use.
13. This product can be used by children aged from 8 years and above and persons with reduced physical, sensory or mental capabilities or lack of experience and knowledge if they have been given supervision or instruction concerning use of the product in a safe way and understand the hazards involved. Children shall not play with the product. Cleaning and user maintenance shall not be made by children without supervision.
14. The supply cord, adaptor, plugs and/or connectors cannot be replaced or modified. If either is damaged, the product should be scrapped.
15. Strobe lights have been known to trigger seizures in people with photosensitive epilepsy.
16. Read, and follow all instructions that are on the product or provided with the product.
17. **SAVE THESE INSTRUCTIONS.**

### **CAUTION:**

1. To reduce the risk of fire or electric shock:
  - Do not install on trees having needles, leaves or branches covering of metal or materials which look like metal;
  - Do not mount or support cords or cables in a manner that can cut or damage wire insulation;
  - Do not attempt to replace lamps or modify power cord;
  - Use only the adaptor provided with this product, and
  - This product does not contain lamp shunts, which allow the product to operate if one lamp burns out.
2. Make sure connectors are fully inserted and any connector rings are twisted until completely secured such that the rings can no longer be turned and the two portions of the connectors are completely assembled.
3. The lighting string is rated 4 Watts (0.8 Amps). Do not overload. Connect other COLOR BLAST™ remote controlled LED lights (Type B) end-to-end up to a maximum of 10 Watts (2.0 Amps) total. To avoid the risk of fire or personal injury, do not exceed the maximum allowable electrical load.

Lollipop Pathway Marker LED Lights

Rated Wattage: 4W (0.8A), Total Wattage: 6.5 Watts

Maximum Wattage Capacity: 10W (2.0A)

### **AC Adaptor**

Input: 120V/60Hz, 0.16A

Output: DC 5V, 2A

## USE AND CARE INSTRUCTIONS

1. Before using or reusing, inspect the product carefully. Discard any products that have cut, damaged or frayed wire insulation or cords, cracks in the lampholders or enclosures, loose connections, or exposed copper wire.
2. When not in use, store in a cool, dry location protected from sunlight.

## SETUP INSTRUCTIONS

1. Take the product out from the box.  
Insert ground stakes into LED lights.
2. Lay the product in a straight line on a flat surface. Identify all parts as indicated below.

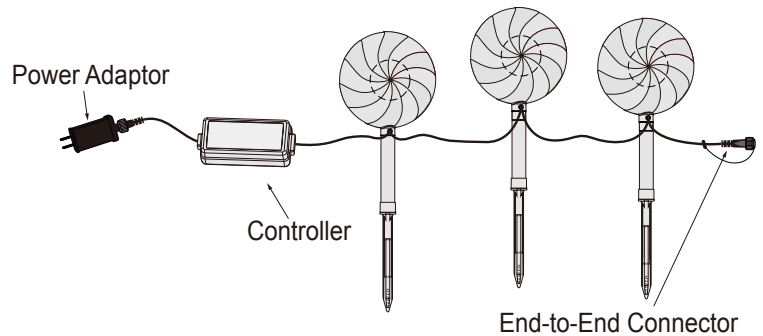
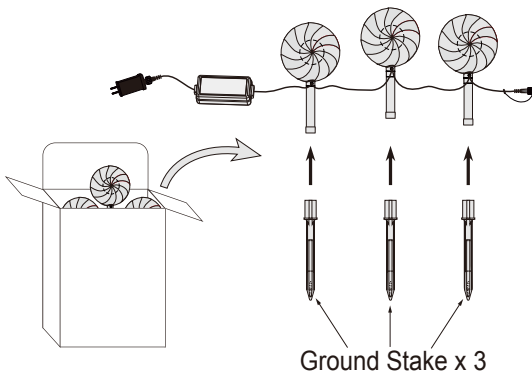

3. Push the ground stake into the ground (soil/lawn) at your desired spot.

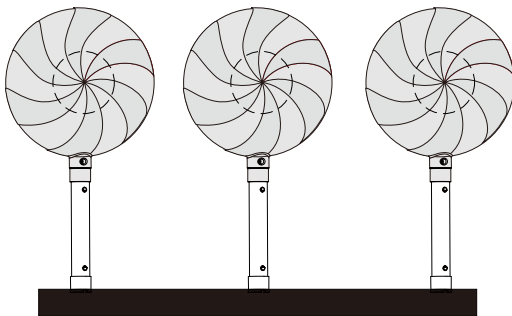

4. Plug it in to the wall outlet.

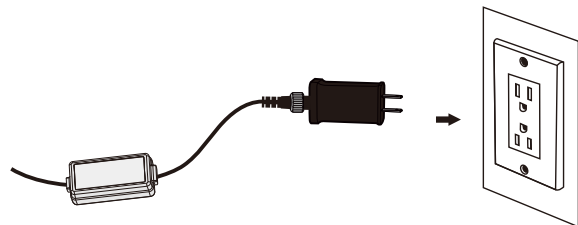

## EXTENDER KIT SETUP INSTRUCTIONS

### Mix-and-Match within the same series for Extra Fun!

This product is connectable with other Color Blast™ Type B LED Lights. Simply calculate the Rated Wattage of all connected products and create your own light show.

**IMPORTANT:** The total Rated Wattage of all connected products should not exceed the Maximum Wattage Capacity of a single product.

#### Example:

- (1) Max. Watt Capacity of Product A: 10W
- (2) Rated Wattage of Product A: 3.5W
- (3) Rated Wattage of Product B: 6.5W

#### Then a feasible connection can be:

$$A \times 1 + B \times 1$$

$$(3.5W) + (6.5W) = 10W$$

$$10W \leq 10W$$

## EXTENDER KIT SETUP INSTRUCTIONS

1. Locate the end-to-end connector and ground stakes of the first kit.

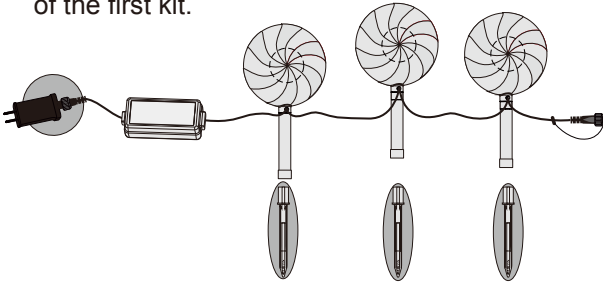

3. Save the power adaptor for future use.

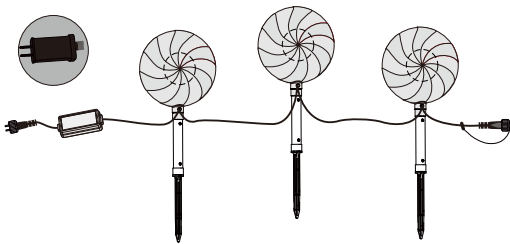

5. Locate the end-to-end connector of the second kit. Open the protective cap to reveal the female connector.

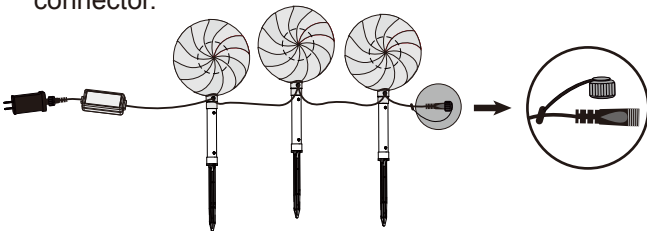

7. Push the ground stake into the ground (soil/lawn) at your desired spot.

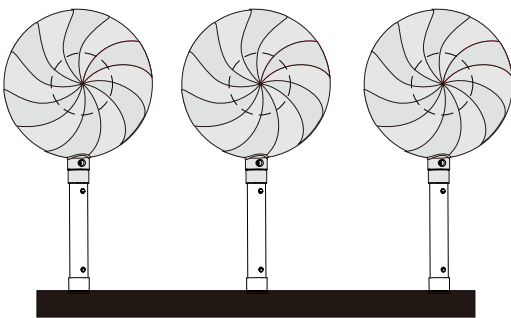

9. Simply use the remote control to enjoy the color spectacle. Please see REMOTE CONTROL INSTRUCTIONS.

2. Unlock the lock nut of the end-to-end connector, and pull apart the plugs to reveal the male connector. Then insert ground stakes into LED lights.

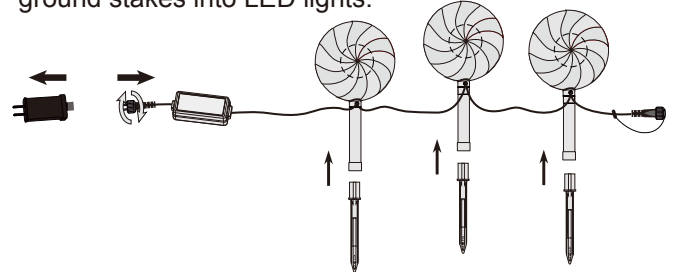

4. Take the second kit out from the box, and insert ground stakes into LED lights.

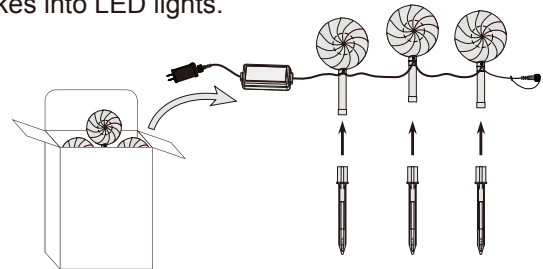

6. Connect the two kits together. Tighten the lock nut to secure the connection.

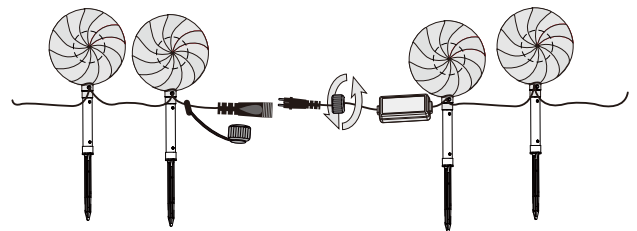

8. Plug it in to the wall outlet.

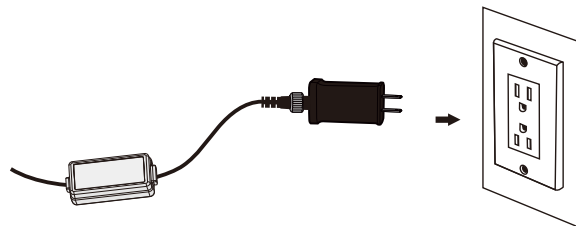

**TIP:** For best signal quality/reception, make sure the controller is placed on a raised area free of obstacles.

# REMOTE CONTROL INSTRUCTIONS

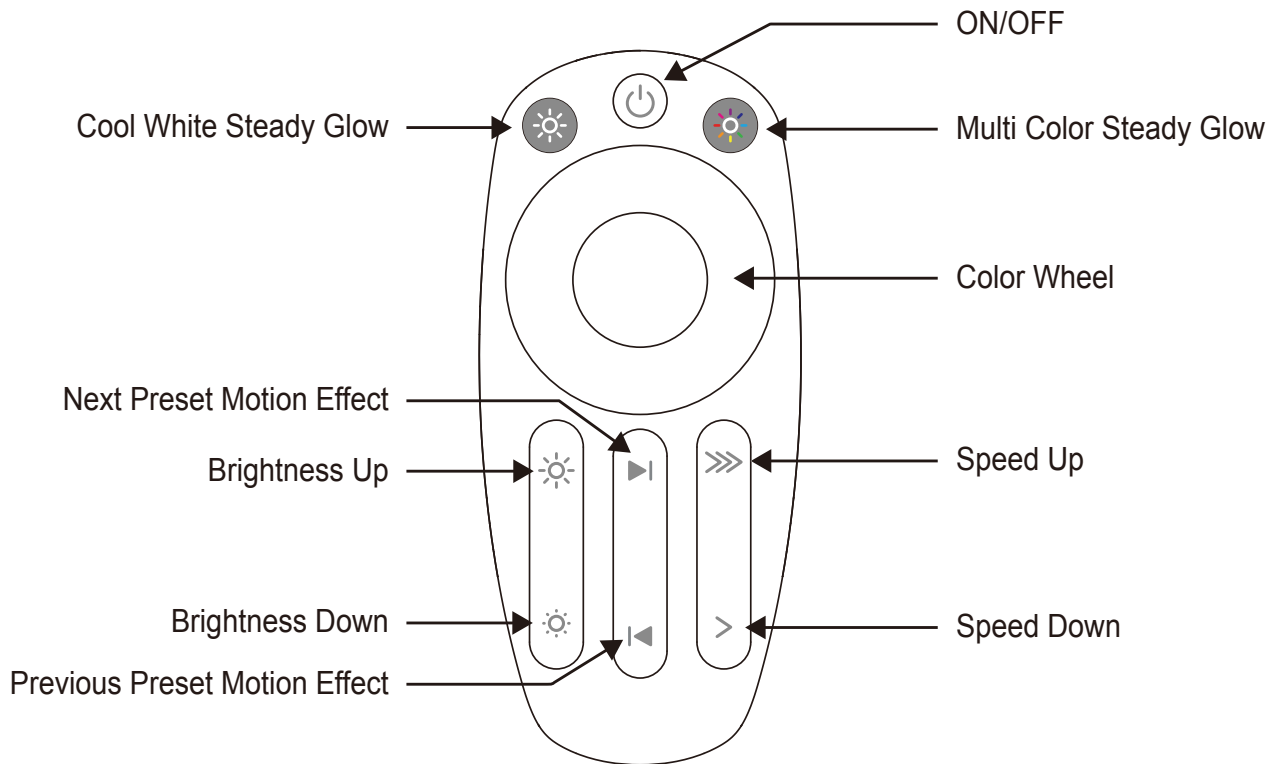

1. Remove the insulation tab before use.
2. Tap to turn lights ON or OFF.
3. Tap the Color Wheel to display all lights in one-color steady glow. Sweep around the color wheel to select your desired color.
4. Tap to display all lights in cool white steady glow.
5. Tap to display all lights in multi color steady glow.
6. Tap or to select from the 8 preset motion effects:
  - Strobe
  - Chasing
  - Fading
  - Rainbow Chasing
  - Stacking
  - Twinkle
  - Rotating
  - Dimple
7. Tap or to adjust the speed of motion effect.
8. Tap or to adjust the brightness of lights.

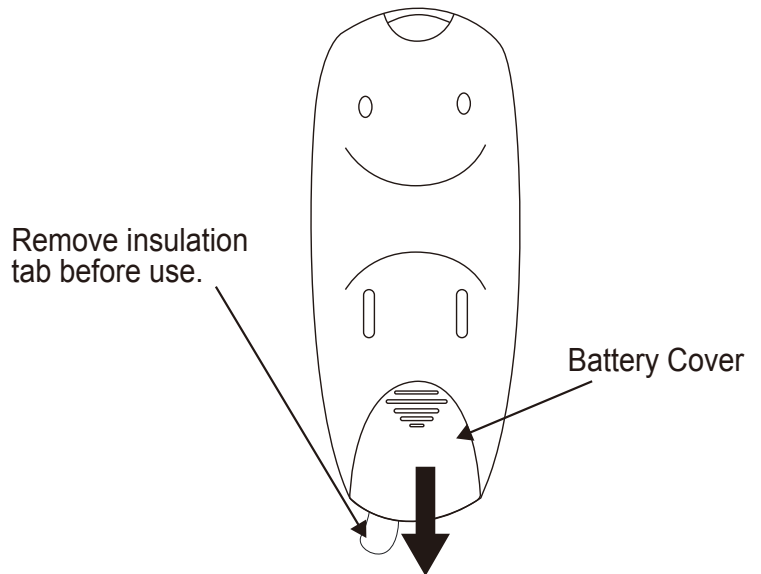

## Battery Replacement

1. Slide open the battery cover.
2. Replace with a new CR2032 button cell battery with correct polarities (+/-) as indicated.
3. Slide the battery cover closed.

## WARNING:

1. SMALL PARTS, KEEP AWAY FROM CHILDREN.
2. Do not expose light set to moisture.
3. Remove batteries when not used for an extended period of time, or when depleted.
4. Dispose of used batteries properly by following directions on batteries.
5. Clean the battery contacts prior to battery installation.
6. DO NOT DISPOSE OF BATTERIES IN FIRE. BATTERIES MAY EXPLODE OR LEAK.