

INSTALLATION

INSTALLATION OVERVIEW

Please read the following installation instructions first after purchasing this product or transporting it to another location.

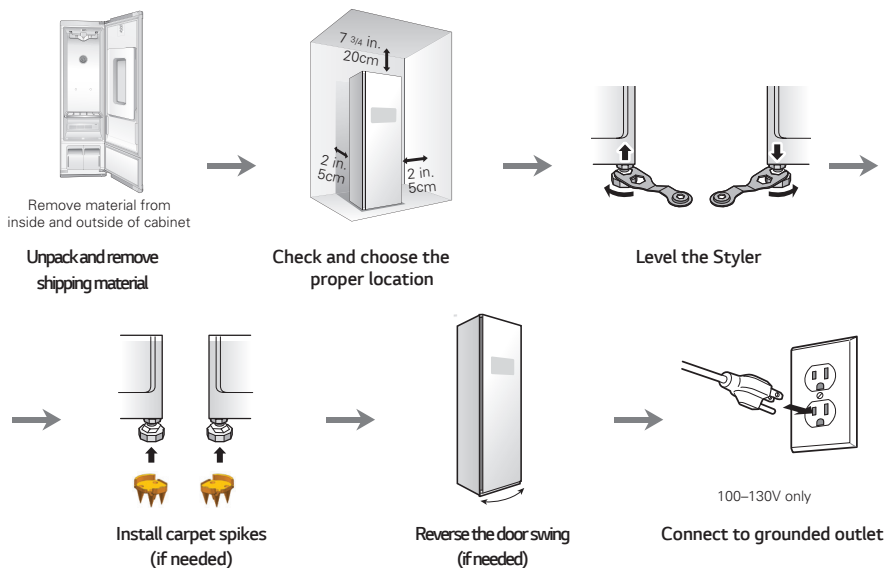

PRODUCT SPECIFICATIONS

The appearance and specifications listed in this manual may vary due to constant product improvements.

steam clothing care	S3*F**
description	electric machine for maintaining clothing
electrical requirements	please refer to the rating label regarding detailed information
dimensions	17 1/2 in. (W) X 23 in. (D) X 72 13/16 in. (H), 39 3/4 in. (D with door open) 445 mm (W) X 585 mm (D) X 1850 mm (H), 1010 mm (D with door open)
net weight	183 lb (83 kg)
maximum capacity	4 items
power consumption	1500 W
safety device	double overheating safety device, thermal fuse, programming

UNPACKING THE STYLER



WARNING

- **Use two or more people to move and install the Styler.** Failure to do so can result in back injury or other injury.
- **The Styler is heavy. Use the wheels at the bottom of the product to move it.** Push the Styler slowly from about halfway down the front side.
- **Keep the Styler upright when moving it.** If you lay the Styler on its side, refrigerant may leak and cause the appliance to malfunction.
- **Keep flammable materials and vapors, such as gasoline, away from the Styler.** Failure to do so can result in fire, explosion, or death.

- **Remove tape and any temporary labels from the Styler before using.**
Do not remove any warning labels, the model and serial number label, or the Tech Sheet that is located under the front of the Styler.
- **To remove any remaining tape or glue, rub the area briskly with your thumb.**
Tape or glue residue can also be easily removed by rubbing a small amount of liquid dish soap over the adhesive with your fingers. Wipe with warm water and dry.
- **Do not use sharp instruments, rubbing alcohol, flammable fluids, or abrasive cleaners to remove tape or glue.**
These products can damage the surface of the Styler.

CHOOSING THE PROPER LOCATION

<p>Electricity</p>	<p>Install where an outlet is easily accessible. Use an individual, grounded outlet: 120 Volts, 60 Hz, AC, 15 Amps minimum.</p> <p> WARNING: Do not plug in multiple appliances in the same outlet with the Styler. Overloading house wiring can cause a fire hazard.</p> <p>To reduce the risk of electric shock, do not install the Styler in a wet or damp area.</p>
<p>Floor</p>	<p>Floor must be level and solid enough to support 183 lb (83 kg). Adjust the leveling legs to compensate for any unevenness in the floor. Do not install on a platform or a weakly supported structure. If installing on carpeting, see <i>Installing on Carpeting</i>, page 17.</p>
<p>Ambient temperature</p>	<p>Temperature must be between 50°F (10°C) and 95°F (35°C). If the ambient temperature is too low or high, performance may be affected. Do not install in direct sunlight or where the temperature may fall below 32°F (0°C).</p>
<p>Clearances</p>	<p>Allow at least 18 in. (46 cm) in front to open the door.</p> <p>Allow at least 2 in. (5 cm) on both sides and between the back of the Styler and the wall. Allow at least 7 3/4 in. (20 cm) between the top of the Styler and any overhanging shelves or cabinets.</p> <p>If the Styler is too close to adjacent items, performance may decrease and electricity consumption may increase.</p>

INSTALLATION LOCATION REQUIREMENTS

⚠ WARNING Read all installation instructions completely before installing and operating the Styler. It is important to review this entire manual before installing and using the Styler.

The installation requires:

- A grounded electrical outlet located within 2 ft. (61 cm) of either side of the appliance.
- A sturdy floor to support the total appliance weight of 183 lbs (83 kg). The combined weight of any other laundry appliances should also be considered.

⚠ WARNING

- **Do not install or store the Styler in an area where it will be exposed to water and/or weather.** Failure to follow this warning could result in risk of electric shock, injury, or product damage or malfunction.

Clearances

⚠ CAUTION

- **The floor must be level, with a maximum slope of 1 inch (2.5 cm) under the Styler.** If the slope is greater than 1 inch (2.5 cm), the appliance cannot be leveled properly.
- **Do not install the Styler on a hollow or flexible platform.** Doing so may cause excessive noise and vibration and result in damage or injury if the product tips over.

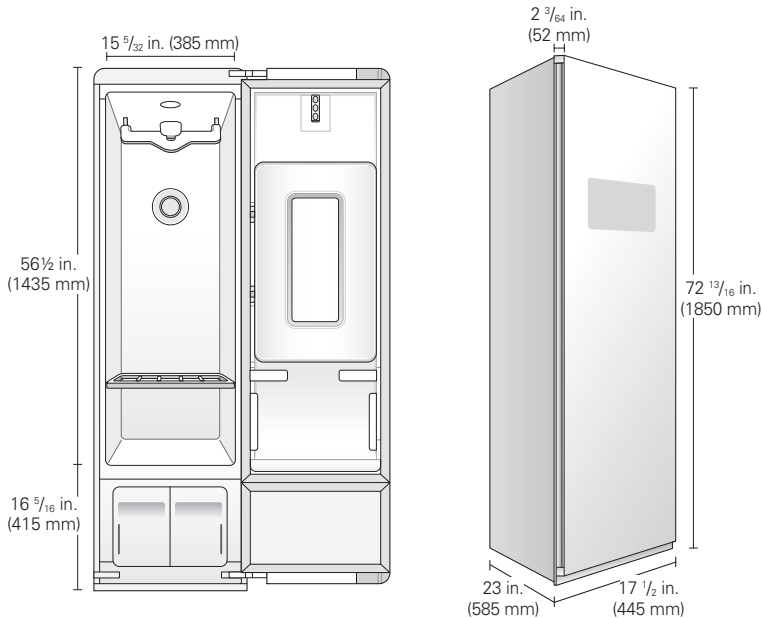

Recommended Installation Spacing

The following clearances are recommended for the Styler. Although the Styler has been tested for clearances of 1³/₁₆ inch (3 cm) on the sides and rear, recommended clearances should be considered for the following reasons:

- Additional space should be considered for ease of installation and servicing.
- Additional space might be required for wall, door and floor moldings.
- Additional space should be considered on all sides of the Styler to reduce noise transfer.
- Additional laundry appliance spacing should also be considered.

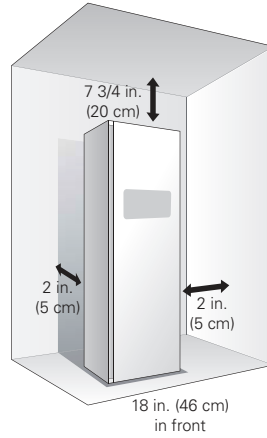

Installation Spacing for Recessed Area or Closet Installation

There should be at least a little space around the Styler (or any other appliance) to avoid contact with walls, furniture, or other appliances during operation. Allow a minimum of 1³/₁₆ inch (3 cm) on all sides of the Styler to avoid increased noise or damage.

- For closet installation, with a door, minimum ventilation openings in the top and bottom of the door are required. Louvered doors with equivalent ventilation openings are acceptable.

- Minimum vent opening for built-in installation is 31 1/2 sq. in. (200 cm²).

Closet Ventilation Requirements

Closets with doors must have both an upper and lower vent to prevent heat and moisture buildup in the closet. One upper vent opening with a minimum opening of 48 sq. in. (310 cm²) must be installed no lower than 6 feet above the floor. One lower vent opening with a minimum opening of 24 sq. in. (155 cm²) must be installed no more than one foot above the floor. One example shown uses vent grilles in the door.

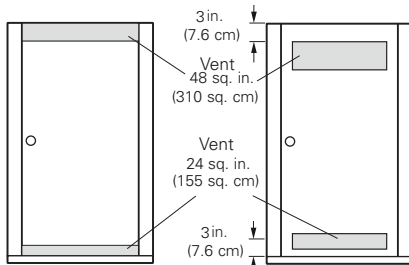

closet door vent requirements

Built-In Installation

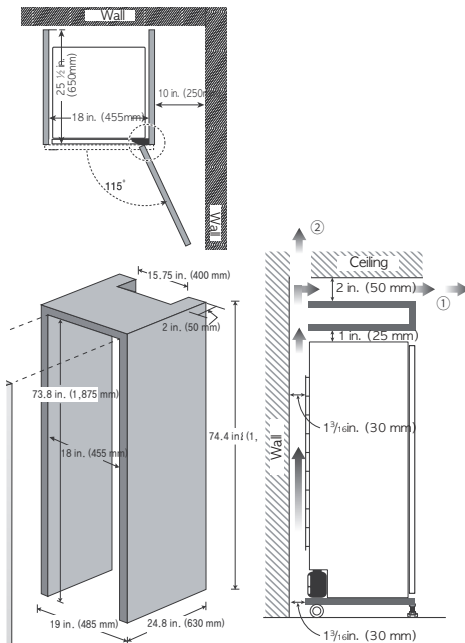

LEVELING THE STYLER



WARNING

- **To reduce the risk of injury to persons, adhere to all industry recommended safety procedures including the use of long-sleeved gloves and safety glasses.**

Failure to follow this warning can cause serious injury or death.

- The appliance is heavy. Two or more people are required when installing the Styler. Failure to follow this warning can cause serious injury or death.
- To ensure that the Styler provides optimal performance, it must be level. To minimize vibration, noise, and unwanted movement, the floor must be a perfectly level, solid surface.



NOTE

Adjust the leveling feet only as far as necessary to level the Styler. Extending the leveling feet more than necessary can cause the Styler to vibrate.

- 1 **Position the Styler in the final location. Check to make sure it is level. If installing on carpet, see *Installing on Carpeting* first.**

- All leveling feet must rest solidly on the floor. Gently push on the corners of the Styler to make sure that it does not rock from corner to corner. Make sure there are no gaps between the front leveling feet and the floor.



WARNING

- **The Styler is heavy. Use two or more people if installing the rear leveling feet.** Failure to do so can result in back injury or other injury.
- **Keep the Styler upright when moving and installing it.** If you lay the Styler on its side, refrigerant may leak and cause the appliance to malfunction.

- 2 **Use the wrench (packaged with the manual) to turn the leveling feet.**

Unscrew the front feet to raise the Styler or screw in the feet to lower it. If unable to level the unit using only the front feet, install the two rear leveling feet by tipping the unit. Do not lay the unit down to install the leveling feet.

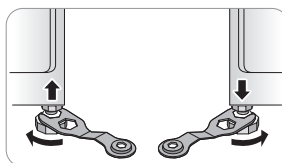

Raise or lower the unit using the leveling feet until the Styler is level from side to side and front to back.



CAUTION

Make sure that all leveling feet are in firm contact with the floor. If the Styler is used without leveling, it may fall, causing injury, damage, or product malfunction.

- 3 **When the Styler is completely stable and all leveling feet are resting solidly on the floor, tighten the locking nuts.**

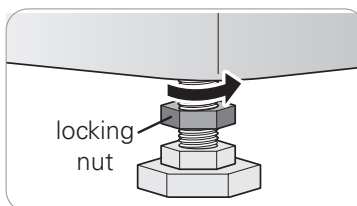

REVERSING THE DOOR

It is possible to reverse the direction of the door swing. This should be done by the installer at the time of installation, if desired.

WARNING

Do not attempt to reverse the door swing yourself. If the direction of the door swing needs to be changed after installation, contact the LG Customer Information Center at 1-800-243-0000 (USA) or 1-888-542-2623 (Canada).

INSTALLING ON CARPETING

If installing the Styler on carpeting, follow these instructions.

WARNING

- **The Styler is heavy. Use two or more people to install the rear leveling feet and carpet spikes.** Failure to do so can result in back injury or other injury.
- **Keep the Styler upright when moving and installing it.** If you lay the Styler on its side, refrigerant may leak and cause the appliance to malfunction.

- 1 **Move the unit into its final location using the back rollers.**
- 2 **Install the two rear leveling feet.**
Tip the unit, do not lay it down, to install the leveling feet.

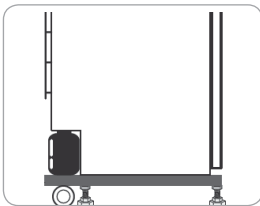

- 3 **Level the unit following the instructions in *Leveling the Styler*.**
- 4 **Install the four carpet spikes on the ends of the leveling feet, with the shorter, octagonal faces toward the front.**

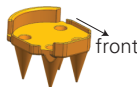

- 5 **After the spikes have been installed, the Styler may need to be leveled again.**

If the carpet has very deep pile or padding, the front feet may need to be extended slightly to install the drip tray.

WARNING

- **Take care when handling the carpet spikes.** They are designed to pierce through the carpet backing and pad and are very sharp.
- **Keep fingers and hands out from under the spikes** when setting the unit in place to avoid personal injury or product damage.

- Be sure to check and empty the drip tray often.
- Do not open the unit during operation to avoid condensation forming on carpet surface, which may result in surface mold or mildew.

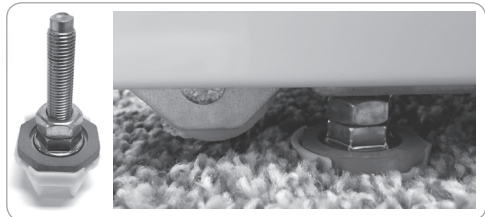

- Keep the bottom of the cabinet dry when filling or emptying water tanks. Keep the outside of the water tanks clean and dry to discourage growth of mold or mildew.

USING NON-SKID PADS (OPTIONAL)

Non-skid pads prevent the product from shaking or shifting when opening or closing the door.

- 1 **Clean the floor to attach the non-skid pads.** Use a dry rag to remove and clean foreign objects or moisture. If moisture remains, the non-skid pads may slip.
- 2 **Adjust the level after placing the Styler in the installation area.**

3 Place the adhesive side of the non-skid pad on the floor.

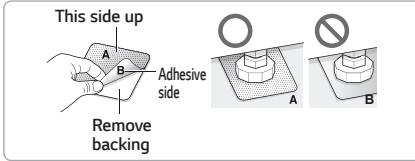

4 Recheck the Styler's levelness.

Push or rock the edges of the appliance gently to make sure that the Styler does not rock. If the Styler rocks, level the appliance again.

- The pads may leave a sticky residue when they are removed. The residue can be removed with alcohol.

INSTALLING THE ANTI-TIP DEVICE

- Appliances can tip, resulting in damage or injuries. Do not operate the unit without the anti-tip device in place and engaged.**

If an anti-tip device is not properly installed, the appliance could be unexpectedly tipped by a child or adult standing, sitting, leaning, or placing excessive weight on an open door or the interior parts.

- Install the anti-tip device packed with the Styler to reduce the risk of tipping.**
Refer to the instructions provided with the anti-tip kit for proper anti-tip device installation.
- Check that the anti-tip device is properly installed.**
With the appliance in its final location, make sure that the slide adjuster on the cord is adjusted until there is about one inch of slack in the cord.
- The use of the anti-tip device does not preclude tipping of the appliance when it is not properly installed.**

ASSEMBLING THE DRIP TRAY

Before using the Styler, insert the drip tray onto the bottom of the cabinet.

- Hold the tray so the arrow and letter on the front of the tray face up.
- Insert one side of the tray first, then the other. Push the tray until it slides completely in.
- To detach, pull one side out then the other. If the tray collects water, detach it and empty the water. After emptying it, re-assemble the tray.

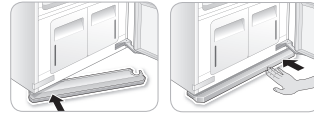

- Do not operate the Styler without installing the drip tray.** Doing so could lead to water damage caused by leaking.

INSTALLING CAP COVERS

- Line up the nubs on the cap cover with the holes in the top corner of the cabinet.
- Snap the cap cover into place. Repeat with the remaining cap cover on the other corner.



INSTALLING HINGE COVERS

- Open the Styler door.
- Snap the hinge cover onto the lower hinge assembly with the bent edge on the far side from the hinge.

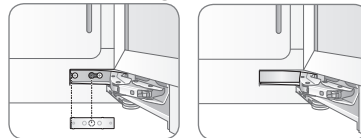

- Repeat with the remaining hinge cover on the upper hinge assembly.

