

# **HOME-FLEX<sup>®</sup>**

A close-up photograph of HOME-FLEX CSST flexible gas pipe and fittings. The pipe is silver-colored with a black stripe and the text 'HOME-FLEX' and 'VPC' visible. Several brass fittings, including elbows and tees, are shown in the foreground and background. The background is a yellowish-green color with a repeating pattern of the HOME-FLEX logo and text.

**CSST Flexible Gas Pipe**

## **System Design and Installation Manual**

## Suggested Tools for Installation of HOME-FLEX®



Tubing Cutter

Use to cut HOME-FLEX® tubing to desired length.



Utility Knife

Use to remove yellow protective jacket at tubing end where the fitting is to be installed.



Slip-joint (or similar) Pliers

Use to compress the retainer ring in place on first corrugation (or valley) of the HOME-FLEX® tubing.



Adjustable Wrenches (x2)

Use in fitting assembly to connect the CSST and NPT ends of the fitting.

(¾" fittings require 1½" or larger wrench opening)



Gloves



Eye Protection

For technical support call: **661-257-3923** or email: **info@homeflex.com**



Escanear el código QR de la derecha, o vaya a [es.homeflex.com](http://es.homeflex.com), para descargar la versión española del *Manual de Instalación y Diseño del Sistema*.

# Table of Contents

## Chapter 1: Introduction

1.1 User Warnings .....	1
1.2 Limitations of Manual .....	2
1.3 Applicable Codes and Standards .....	3

## Chapter 2: Description of System Components

2.1 Tubing .....	4
2.2 Fittings .....	5
2.3 Striker Plates .....	6
2.4 Pressure Regulators .....	6
2.5 Manifolds .....	6
2.6 Shut-off valves and Quick-Connect Devices .....	6
2.7 Bonding Clamps .....	7
2.8 Protection Devices .....	7
2.9 HOME-FLEX® Tubing Cutter .....	8
2.10 Replacement Parts .....	8
2.11 HOME-FLEX® Appliance Connectors .....	9

## Chapter 3: Sizing and Configurations

3.1 Configuration .....	10
Low Pressure Systems .....	11
Dual Pressure Systems .....	12
Hybrid Systems (Rigid pipe and CSST) .....	12
3.2 Sizing Methods and Examples .....	12
Sizing Tables .....	12
Low Pressure systems (Longest Length/Branch Method) .....	13
Elevated Pressure Systems .....	15
Hybrid CSST & Black Iron Rigid Pipe Systems .....	17

## Chapter 4: Installation Practices

4.1 General Practices .....	19
4.2 Fitting Assembly .....	20
Male, Female, Union and Tee Fitting Assembly .....	21
Termination Fitting Assembly .....	23
Troubleshooting Fitting Connections .....	24
4.3 Routing .....	24
General Routing Practices .....	24
Clearance Holes and Notching .....	25
Concealed Locations for Fittings .....	26
Outdoor Installation .....	27
4.4 Protection .....	28
Striker Plates .....	28

Through-Wall Penetration .....	29
<b>4.5 Meter connections .....</b>	<b>29</b>
Connection by Special Termination Fitting .....	29
Direct Connection .....	29
<b>4.6 Appliance connections .....</b>	<b>30</b>
Termination Fittings with Appliance Connectors .....	30
Direct Connection .....	30
Pad-Mounted Equipment .....	31
Roof Top Equipment .....	31
Outdoor Appliances: Barbecue Grills, Gaslights, and Heaters .....	31
<b>4.7 Manifold Stations .....</b>	<b>33</b>
<b>4.8 Pressure Regulators .....</b>	<b>33</b>
Installation Requirements .....	33
Vent Limiters and Vent Lines .....	34
Performance Testing .....	35
Regulator Adjustments .....	35
<b>4.9 Underground Installations .....</b>	<b>35</b>
<b>4.10 Electrical Bonding .....</b>	<b>36</b>

## **Chapter 5: Inspection, Repair, and Replacement of CSST**

<b>5.1 Minimum Inspection Requirements Checklist .....</b>	<b>38</b>
<b>5.2 Repair of Damaged Tubing .....</b>	<b>39</b>
When Pipe Needs to be Replaced .....	39
Method Of Repair: Splice or Replace? .....	39

## **Chapter 6: Pressure Test Procedures**

<b>6.1 Procedure For Low Pressure Systems .....</b>	<b>40</b>
<b>6.2 Procedure For Elevated Pressure Systems .....</b>	<b>40</b>
<b>6.3 Appliance Connection Check Procedure .....</b>	<b>41</b>

## **Chapter 7: Sizing/Capacity Tables**

<b>7.1 Natural Gas Sizing Tables .....</b>	<b>42</b>
7 in / 0.5 in WC Drop .....	43
7 in / 1 in WC Drop .....	43
8-10 in / 3 in WC Drop .....	44
12-14 in / 6 in WC Drop .....	44
2 PSI / 1 PSI Drop .....	45
5 PSI / 3.5 PSI Drop .....	45
<b>7.2 Liquid Petroleum (LP) Sizing Tables .....</b>	<b>46</b>
11 in / 0.5 in WC Drop .....	46
13-14 in / 2.5 in WC Drop .....	46
2 PSI / 1 PSI Drop .....	47
5 PSI / 3.5 PSI Drop .....	47
<b>7.3 Steel Pipe Capacity Chart .....</b>	<b>48</b>
7 in / 0.5 in WC Drop .....	48

## **Chapter 8: Technical Information Sheet .....**

## **Chapter 9: Definitions .....**

# Chapter 1: Introduction

## 1.1 User Warnings

HOME-FLEX® Corrugated Stainless Steel Tubing (CSST) flexible gas piping material must be installed by a Qualified Installer who has been certified in the use of the HOME-FLEX® gas piping system. Certification can be completed by reading this *System Design and Installation Manual* and registering with Valencia Pipe Company to obtain a Qualified Installer Card by either mailing in the registration card at the back of the manual, or filling out the online form at [register.homeflex.com](http://register.homeflex.com). In submitting either the printed or online registration, you are asserting that you understand all aspects of the installation requirements and local plumbing, mechanical, electrical and/or building codes applicable at the locale where HOME-FLEX® is to be installed. If you do not understand all aspects of the installation requirements and local codes, locate a Qualified Installer in your area who does. You must presently possess, or attain prior to installing, a HOME-FLEX® Qualified Installer Card to install HOME-FLEX® CSST.

Additional resources beyond this guide can be accessed on the HOME-FLEX® website: [www.homeflex.com](http://www.homeflex.com). Installers must meet applicable qualifications set forth by the state and/or local administrative authorities which enforce the plumbing, mechanical and/or electrical codes where the gas piping is being installed.

This HOME-FLEX® *System Design and Installation Manual* provides general instructions for the design and installation of flexible gas piping systems using HOME-FLEX® branded CSST. It is not to be used as a guide for the installation of other manufacturers' CSST products.

The HOME-FLEX® *System Design and Installation Manual* is to be used in conjunction with state and local building codes. In the event of a conflict between this guide and local codes, the local code takes precedence. In the absence of local codes, installation shall comply with the current edition of the *National Fuel Gas Code* (ANSI Z223.1/NFPA 54), the *National Standard of Canada*, the *Natural Gas and Propane Installation Code* (CSA B149.1), the *Uniform Plumbing Code*, the *Federal Manufactured Home Construction and Safety Standards* (ICC/ANSI 2.0), the *Standard on Manufactured Housing* (NFPA 501), the *National Electric Code* (NFPA 70), and/or the *Standard for the Installation of Lightning Protection System* (NFPA 78), as applicable. Due to CSST code changes for the State of Massachusetts, a separate HOME-FLEX manual has been issued for this state.

The instructions and procedures outlined in the HOME-FLEX® *System Design and Installation Manual* must be strictly adhered to for a safe and effective installation. Prior to beginning installation, competent engineering practices and principles must be employed in designing the system, taking into account local codes, requirements of the natural gas utility or propane supplier, and the requirements of the gas system being installed. All installations must be inspected by the local authority that oversees gas plumbing prior to the supplying of gas to the system.

HOME-FLEX® tubing and fittings are engineered and tested to work in combination. Using HOME-FLEX® CSST tubing or fittings with the tubing or fittings of other CSST flexible gas piping manufacturers is strictly prohibited and could lead to serious bodily injury or property damage.

Exposure to high voltage electricity may cause damage to CSST systems. Strict adherence to Section 4.10, "Electrical Bonding" (p. 34), will mitigate potential damage.

Wear gloves, eye protection, and suitable protective clothing when working with HOME-FLEX® CSST and fittings.



**Valencia Pipe Company**

28839 Industry Drive Phone: 661-257-4403

Email: [info@homeflex.com](mailto:info@homeflex.com)

Valencia CA 91355

Fax: 661-257-3928

[www.homeflex.com](http://www.homeflex.com)

Copyright © 2016, HOME-FLEX, LLC. HOME-FLEX® and the VPC logo are registered trademarks of Valencia Pipe Company, Inc. All rights reserved. 1604/A

## Introduction

**WARNING!** If installed improperly, fire, explosion or asphyxiation may result. Installation instructions and applicable local codes must be strictly followed.

**CALIFORNIA PROPOSITION 65 WARNING:** This product contains one or more chemicals known to the State of California to cause cancer, birth defects, or other reproductive harm. **Wash hands after handling.**

## 1.2 Limitations of Manual

This *System Design and Installation Manual* is intended to assist the qualified gas pipe installer in the design, installation, and testing of the HOME-FLEX® flexible gas piping system for residential, commercial, and industrial buildings. It is not possible for this guide to anticipate every variation in construction style, building configuration, appliance requirement, or local restriction. This document will not cover every application. The user should either exercise his own engineering judgment on system design and installation, or seek technical input from qualified sources. Additional information on gas piping systems is available from your local gas utility or propane supplier. General usage guidelines of HOME-FLEX® flexible gas piping are outlined as follows:

The piping system is for use with fuel gases only and is intended for operating pressures not exceeding 5 PSI (34.5 kPa). The maximum actual operating pressure, including transients, shall not in any case exceed 6.5 PSI (44.8 kPa) for 5 PSI (34.5 kPa) rating.

Precautions shall be taken by the installer to ensure any exposed tubing is not damaged or abused during building construction or reconstruction.

Only the components provided or specified by Valencia Pipe Company, Inc. are to be used in the installation.

The size and depth of installation clearance holes or notches for routing the tubing through wall studs and joists shall comply with the requirements of the local building code.

Concealed tubing shall be protected from puncture threats, using the shielding devices specified by Valencia Pipe Company, at all points of penetration through studs, joists, plates or similar structures. The extent of protection shall be defined as follows:

- At points of penetration less than 2" (50.8 mm) from any edge of a stud, joist, plate, etc., a listed striker plate is required to provide protection at the area of support and within 5 in (127 mm) of each side (if appropriate) of the support.
- At points of penetration 2" - 3" (50.8 to 76.2 mm) from any edge of a stud, joist, plate, etc., a listed striker plate is required to provide protection throughout the area of support.
- At points of penetration greater than 3" (76.2 mm) from any edge of a stud, joist, plate, etc., no protection is required.
- Tubing routed horizontally through studs shall be protected from puncture threats between the studs using the shielding devices specified.
- Tubing greater than 1" (25.4 mm) inside diameter installed within hollow cavity walls of 2 x 4 construction shall be protected along the entire concealed length in the manner and using the shielding devices specified by Valencia Pipe Company.
- The width of the installed striker plate, at the points of penetration through wall studs, floor joists, plates, sills, etc., shall be at least 1.5 times the outside diameter of the tubing.

The inspection, testing and purging of the installation shall be performed using the procedures specified in Part 4, General, of the *National Fuel Gas Code* (ANSI Z223.1/NFPA 54), and/or the *Natural Gas and Propane Installation Code* (CSA B149.1), the *International Fuel Gas Code*, the *Uniform Plumbing Code*, or in accordance with the requirements of the applicable local

codes. The installed gas piping system shall not exhibit any loss of pressure during the field pressure test.

When routing HOME-FLEX® tubing, sharp bends, stretching, and kinking or twisting of the tubing are to be avoided as these can damage the CSST tubing. The minimum permissible bend radius of HOME-FLEX® tubing is 1¼" (32 mm) for ½" tubing, 1⅝" (42 mm) for ¾" tubing, and 2" (51 mm) for 1" tubing. Under no circumstances is this minimum bend radius to be exceeded.

The piping system shall not be used as a grounding electrode for an electrical system.

### 1.3 Applicable Codes and Standards

Model codes which list CSST as an acceptable gas piping material:

ANSI/IAS LC-1 / CSA 6.26 Standard

CANADA-CSA B149.1 *Natural Gas and Propane Installation Code*

CANADA-CSA B149.2 *Propane Storage and Handling Code*

BOCA: *National Mechanical Code*

CABO: *One and Two Family Dwelling Code*

*California Mechanical and Plumbing Codes*

IAPMO: *Uniform Plumbing Code*

ICBO: *Uniform Mechanical Code*

ICC: *International Fuel Gas Code*

ICC: *International Mechanical Code*

ICC: *International Residential Code*

NFPA 54/ANSI Z 223.1 *National Fuel Gas Code*

NFPA 58: *Storage and Handling of LP Gases*

SBCCI: *Southern Building Code Congress International*

Tested to Code Requirements per ASTM E84 / UL 723

This *System Design and Installation Manual* has been written in accordance with the most current edition of ANSI LC1 CSA 6.26, *Fuel Gas Piping Systems using Corrugated Stainless Steel Tubing (CSST)*.



Items marked with the UPC logo are IAPMO certified for the United States and Canada.



Items marked with the CSA logo are CSA certified for the United States and Canada.

**NOTE:** CSST approval from the above codes does not mean that CSST is approved for use in all localities. It is the installer's responsibility to confirm that CSST is accepted by the local authority with jurisdiction over the installation site. Valencia Pipe Company assumes no responsibility for materials or labor expenses incurred as a result of the installer not verifying local approval.

# Chapter 2: Description of System Components

## 2.1 Tubing

The HOME-FLEX® fuel gas piping system employs corrugated, flexible, semi-rigid stainless steel tubing with brass attachment fittings terminating in NPT pipe fittings for integration into traditional rigid black pipe systems or direct connection to gas systems. Tubing is available in sizes of ½", ¾", and 1".

HOME-FLEX® tubing is jacketed with a yellow polyethylene cover clearly marked with gas pressure rating, and EHD\* (Equivalent Hydraulic Diameter). Tubing is available in lengths of 25 (½" and ¾" only), 75, 150 (1" only), and 250-feet (½" and ¾" only).

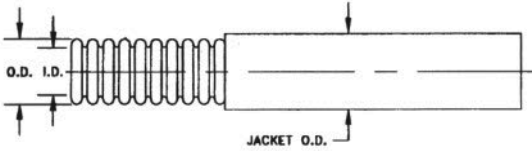

Part No.	Size (in)	EHD* (AGA Size)	Jacket OD (max)	Inside diameter (nom)	Wall Thickness
11-005	½"	18	0.76"	0.551"	0.01"
11-007	¾"	25	1.06"	0.827"	0.01"
11-010	1"	31	1.29"	1.06"	0.01"

\* EHD (Equivalent Hydraulic Diameter): a relative measure of flow capacity. A higher EHD value indicates greater flow capacity of pipe.

Part No.	Size (in)	Length	
11-00525	½"	25'	
11-00575	½"	75'	
11-005250	½"	250'	
11-005500	½"	500'	
11-00725	¾"	25'	
11-00775	¾"	75'	
11-007250	¾"	250'	
11-007500	¾"	500'	
11-01075	1"	75'	
11-010150	1"	150'	



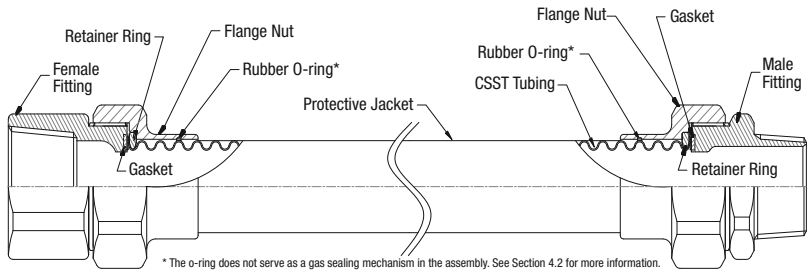























Figure 2.1 HOME-FLEX® Tubing and Fitting Assembly

## 2.2 Fittings

HOME-FLEX® fittings are available for ½", ¾", and 1" HOME-FLEX® tubing and allow for easy connection to gas systems and accessories using standard NPT threads. (See Figure 2.1)



In addition to standard NPT adapter fittings, the following are also available: Tee fittings to accommodate branch lines in tubing runs, reducer tees to integrate with different sized tubing runs, and special termination flanges for convenient gas appliance connections.

	Part No.	Description	
	11-436-005	½" Male NPT x CSST	
	11-436-007	¾" Male NPT x CSST	
	11-436-010	1" Male NPT x CSST	
	11-435-005	½" Female NPT x CSST	
	11-435-007	¾" Female NPT x CSST	
	11-435-010	1" Female NPT x CSST	
	11-401-005	½" x ½" x ½" Tee	
	11-401-007	¾" x ¾" x ½" Tee	
	11-401-010	1" x 1" x ¾" Tee	
	11-429-101	¾" CSST x ½" Male NPT Reducer	
	11-429-005	½" Union (CSST x CSST)	
	11-429-007	¾" Union (CSST x CSST)	
	11-429-010	1" Union (CSST x CSST)	
	11-464-005	½" Termination Flange	
	11-464-008	¾" Termination Flange	

**Description of System Components**

**2.3 Striker Plates**

Striker plates are used to protect CSST from puncture hazards when passed through studs, joists, and other building materials.

	Part No.	Description
	11-3070SP	4" x 9" Striker Plate 

**2.4 Pressure Regulators**





Pressure regulators are used in elevated pressure system installations (over 14 inches water column, or 1/2 PSI) to reduce pressure to standard low pressure required for appliances.

	Part No.	Description
	Maxitrol 325-3L	1/2" NPT 7-11" w.c. Gas Line Pressure Regulator (250,000 Btu/hr max)
	Maxitrol 325-5AL	3/4" NPT 7-11" w.c. Gas Line Pressure Regulator (425,000 Btu/hr max)

**Note:** The regulators listed are for reference only. They are not distributed or supported by Valencia Pipe Company.

**2.5 Manifolds**

Manifolds allow for parallel installations of HOME-FLEX® tubing with runs to each appliance. Manifolds are available with 1/2" or 3/4" inlets and have four 1/2" or 3/4" NPT outlets.

	Part No.	Description
	11-050504	1/2" x 1/2" x 1/2" Female NPT 
	11-070504	3/4" x 3/4" x 1/2" Female NPT 
	11-100704	1" x 1" x 3/4" Female NPT 

**2.6 Shut-off valves and Quick-Connect Devices**





At pressures less than 1/2 PSI (3.45 kPa), manual shut-off valves (ball valves) must comply with ANSI Z21.15 / CGA 9.1 *Manually Operated Gas Valves for Appliances, Appliance Connector Valves and Hose End Valves*, or with ANSI/ASME B16.44 *Manually Operated Metallic Gas Valves for Use in Above Ground Piping Systems up to 5 PSI*.

When operating at pressures at or exceeding 1/2 PSI, manual gas valves are to have a pressure rating of at least 5 PSI (34.5 kPa) and must comply with ANSI/ASME B16.33 *Manually Operated Metallic Gas Valves for Use in Gas piping Systems Up to 125 Psig*, or with IAS U.S. Requirement No. 3-88 *Manually Operated Gas Valve for Use in House Piping Systems*, or with CGA 3.16 *Lever Operated Non-Lubricated Gas Shut-Off Valves*, or with CGA 3.11 *Lever Operated Pressure Lubricated Plug Type Gas Shut-Off Valves*, or with CGA CR91-002 *Manually Operated Gas Valves for*

*Use on Gas Piping.* Valves listed as complying with IAS U.S. Requirement 3-88 or CGA CR91-002 but not ASME B16.33 or CGA 3.11 are not to be installed outdoors.

Valves must be used in the following conditions:

- a) Gas appliances must have an accessible ½ PSIG manual shut-off valve upstream of connectors with a union to allow removal of appliance
- b) An accessible manual gas shut-off valve is required upstream of each pressure regulator on elevated pressure systems.

	Part No.	Description
	HFSB-1515	⅜" Female NPT Ball Valve 
	HFSB-2424	½" Female NPT Ball Valve 
	HFSB-3434	¾" Female NPT Ball Valve 
	HFSB-4444	1" Female NPT Ball Valve 

Quick-connect devices provide a safe and easy way to make connections to moveable outdoor gas appliances like barbecues and space heaters. Quick-connect devices used with HOME-FLEX® gas piping systems must conform to ANSI Z21.15, CGA 9.1, 9.2, 6.9 and AGA/CGA 7-90/CR94-001. A shut-off valve should be installed upstream of the quick-connect device and remain in the off position when the quick-connect device is not in use. All installations and devices must conform with local codes. Quick-connect devices that can be used with HOME-FLEX® gas piping systems include, but are not limited to, models in the M. B. Sturgis 3/375 family of products.

## 2.7 Bonding Clamps

Bonding clamps are used to connect the CSST gas piping system to the structure's existing grounding system. Connection is to be made to a HOME-FLEX® fitting or black-iron component nearest the gas service entrance of the building (see Section 4.10 on page 34). Connection is never to be made directly to the HOME-FLEX® tubing.

	Part No.	Description
	11-05BC	Bronze UL 467 listed bonding clamp for use with ½" and ¾" systems

## 2.8 Protection Devices

Like striker plates, HOME-FLEX® Flexible Protective Conduit is used to protect HOME-FLEX® tubing from puncture hazards.

	Part No.	Description
	11-12512	1¼" x 12" Flexible Protective Conduit (For use with ½" & ¾" CSST)

**Description of System Components**





## 2.9 HOME-FLEX® Tubing Cutter

The HOME-FLEX® Tubing Cutter is specially designed to cut HOME-FLEX® and other brands of CSST, as well as aluminum, brass, copper, and stainless steel tubing. It can accommodate tubing with an outer diameter (O.D.) from 0.2" to 1.25".

	Part No.	Description
	11-TC-02125	Tubing Cutter designed for ½", ¾" and 1" HOME-FLEX® CSST
	11-TCB-02	Pack of 2 replacement blades

## 2.10 Replacement Parts

HOME-FLEX® fittings require a retainer ring, a non-metallic gasket, and an o-ring for proper assembly (see Figure 2.1 on page 5). Should any of these components be damaged or misplaced, packs of replacement rings are available.

	Part No.	Description
	11-05C	Two each of replacement rings, gaskets, and o-rings for ½" fittings 
	11-07C	Two each of replacement rings, gaskets, and o-rings for ¾" fittings 
	11-10C	Two each of replacement rings, gaskets, and o-rings for 1" fittings 

## 2.11 HOME-FLEX® Appliance Connectors

HOME-FLEX® CSST cannot be used to make direct connections to moveable appliances like gas ranges or clothes dryers (see Section 4.6 on page 29). Connection to these appliances should be made from a HOME-FLEX® Termination Flange fitting to a HOME-FLEX® Appliance Connector, or comparable device. Appliance connectors are available coated and uncoated in lengths of 12, 18, 24, 30, 36, 48, 60 and 72 inches with a variety of end fittings. Browse the full product line at [homeflex.com](http://homeflex.com). Determine the correct appliance connector for your application by identifying the required length to connect the gas outlet to the appliance inlet and select the series that offers a maximum flow rate greater than the maximum demand of the appliance.

	Length	Maximum Flow Rate (CFH) by Series				
		HFHC	HFDC	HFRC	HFSA	
		3/8" OD 1/4" ID	1/2" OD 3/8" ID	5/8" OD 1/2" ID	1" OD 3/4" ID	
	12"	52,400	117,750	192,000	481,250	CS
	18"	49,900	110,975	181,400	458,925	CS
	24"	47,400	104,200	170,800	436,600	CS
	30"	44,900	97,425	160,200	414,275	CS
	36"	42,400	90,650	149,600	391,950	CS
	48"	37,400	77,100	128,400	347,300	CS
	60"	34,250	70,950	116,650	323,850	CS
	72"	31,100	64,800	104,900	300,400	CS

# Chapter 3: Sizing and Configurations

## 3.1 Configuration

Before routing HOME-FLEX® tubing, it is advisable to prepare a sketch from the building plans showing the locations of appliances to be serviced by the gas line, the load demands of each appliance, the point of delivery (location of gas meter or second stage liquid petroleum (LP) regulator), system pressure, and possible piping routes and lengths. Appliance load requirements can be obtained from the manufacturer's nameplate located on the appliance, or provided to you by the builder or contractor. Performing this sketch will ensure that you select the proper HOME-FLEX® tubing and accessories and avoid potentially costly corrections to the installation.



- a) Determine local piping restrictions prior to purchasing and installing HOME-FLEX® flexible gas tubing. In particular, confirm that the local administrative authority governing the installation location has accepted the use of Corrugated Stainless Steel Tubing (CSST) flexible gas piping. While CSST is accepted by the major national and international code bodies, adoption of local codes can lag behind these bodies, and/or have special requirements in addition to the national codes.
- b) Determine the metered (supply) pressure of the gas source at the installation location.
  - i) Natural Gas
    - Standard low-pressure supply in North America is usually 6-7 inches water column (w.c.), alternatively designated as ¼ PSI.
    - Medium pressure supply, such as 14 inches w.c. (½ PSI) provides significant CSST size reduction. Check with the local gas utility for the availability of medium pressure. Most appliances distributed in the US and Canada are designed to operate up to 14 inches w.c.
    - Elevated pressure supply of 2 PSI is typically the highest pressure supplied within residential buildings in the US and Canada. Installations for systems of this pressure always require installation of a pounds-to-inches pressure regulator between the utility meter and the appliances.
  - ii) Propane (Liquefied Petroleum or LP) Gas
    - The pressure of LP systems are traditionally set to 11 inches w.c. at the second stage regulator of the system.
    - Like natural gas, elevated pressure settings from 14 inches w.c. to 2 and 5 PSI provide CSST size reductions. Check with the gas supplier for availability. For 2 PSI and greater, use a gas line pressure regulator set to 11 inches w.c. outlet pressure at the appliance side of the LP system.
- c) Determine the load demand of each appliance to be used at the installation location and the total load for all appliances to determine the total capacity needed for the installation. CFH/BTUH equivalents for natural gas or propane flow can be obtained from the local gas utility or propane supplier. The capacity tables within this guide should be used to determine the tubing size required to meet BTUH input load requirements.

- For natural gas with a specific gravity of 0.60, one cubic foot per hour (1 CFH) is approximately 1,000 BTUH.
- For LP gas with a specific gravity of 1.52, one cubic foot per hour (1 CFH) is approximately 2,500 BTUH.

For any given system and its load requirements, there are several piping system designs available to the installer using HOME-FLEX® tubing. The sections below will outline several demand scenarios and the different system options open to the installer. It would be impossible to outline all the possible installation methods. It is the installer's responsibility to use the information supplied here to determine the best routing solution, using these examples as a guide.

### Low Pressure Systems

In low pressure systems, there are two installation options: series layouts where a main run from the gas source splits to each appliance, and parallel layouts where the main run from the gas source leads to a central distribution manifold from which individual runs service the appliances.

#### Low Pressure Series Systems

Series systems are the most commonly used layout for black steel pipe installations with low pressure supplies. In series layouts, a main run from the gas source is branched with tees to each appliance. The service pressure downstream of the meter is typically less than ½ PSI.

It is important to consider the minimum pressure supplied to any given appliance in a series layout. Most natural gas appliances require a minimum of 4" w.c. pressure, while LP appliances require a minimum of 10" w.c. pressure. Local code restrictions may dictate allowable pressure drop along any particular run.

#### Low Pressure Parallel Systems

Parallel systems have a central distribution manifold with branch runs to the appliances. Typically, a main supply line is run from the gas supply to a manifold and "home runs" are routed to each appliance location. Manifold stations are located as close as possible to the appliance(s) with the greatest load. Parallel layouts are most commonly used in ¼ to ½ PSI systems.

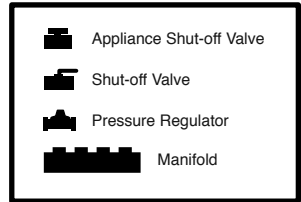

Figure 3.1 Routing Diagram Key

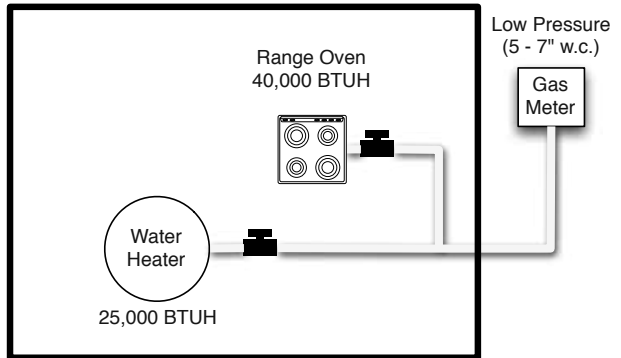

Figure 3.2 A low pressure series layout

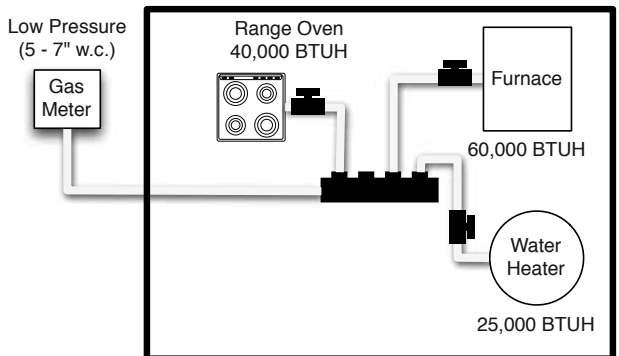

Figure 3.3 A low pressure parallel layout

## Sizing and Configurations

### Dual Pressure Systems

Elevated pressure systems generally have a main line from the gas supply to one or more gas pressure regulators and then a manifold with "home runs" to appliances. These runs may branch off through use of a tee, if gas loads permit.

#### Elevated Pressure System

It is also possible to have a complete elevated pressure system where the pressure regulators are positioned at each appliance. This method is typically employed in systems with high loads or long runs.

#### Multiple Manifold System

Another variant used with elevated pressure is to have multiple manifolds, each with a regulator before the manifold. This approach allows for large BTU load demands while using smaller diameter tubing.

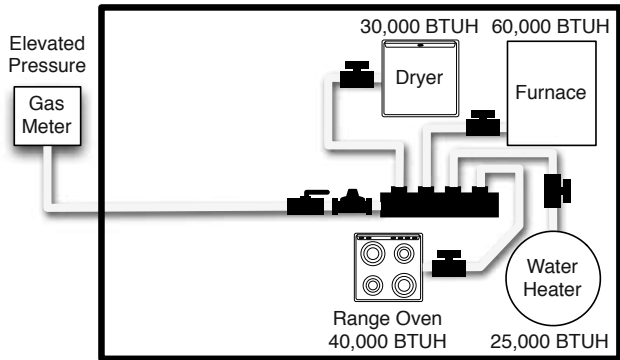

Figure 3.4 A dual pressure system layout

### Hybrid Systems (Rigid pipe and CSST)

The use of both CSST and rigid black pipe can be advantageous to minimize the pressure drops typically encountered on systems with high loads or long runs. For example, a parallel system could require a larger diameter main branch to provide the total appliance load. HOME-FLEX® is certified for use with black steel pipe and copper tubing gas piping systems.

## 3.2 Sizing Methods and Examples

This section will outline sizing procedures under several different circumstances to demonstrate how to select the proper size and configuration of HOME-FLEX® flexible gas tubing. These examples are presented to demonstrate the process of using sizing tables to determine necessary pipe size and configuration. Every installation is different and this requires that the installer go through the processes outlined below for the proper sizing and configuration of the gas piping system given the circumstances and requirements at the installation location.

### Sizing Tables

All piping systems introduce pressure loss, the amount of which depends on the piping size and the gas flow (in cubic feet per hour). When "sizing" a system, the installer determines the smallest size piping that will deliver the flow required given the allowable amount of pressure drop. Sizing tables provide the maximum load for a run given the gas pressure, allowable pressure drop, size of pipe and the length of the run. Different sizing tables are used for each combination of system pressure and pressure drop.

Allowable pressure drop is the maximum pressure loss that can occur and maintain supply pressure for proper equipment or appliance operation. Natural gas appliances are generally designed to function with a minimum pressure of 4 inches w.c. LP appliances are generally designed for a minimum pressure of 10 inches w.c. The sizing tables in this guide should be used to provide no less than 5 inches w.c. to natural gas appliances and 10.5 inches w.c. to LP appliances.

Allowable pressure drop can be calculated by subtracting the desired appliance inlet pressure (recommended 5 inches w.c. for natural gas and 10.5 inches w.c. for propane) from the gas source pressure (gas meter for natural gas or the secondary regulator for LP).



Low pressure series systems are sized using the "longest length method" (also known as the "branch length method") in the same manner as low pressure black steel pipe systems. Tables from the *National Fuel Gas Code* (NFPA 54) are used to calculate the sizing. Pressure drop in a low pressure system is usually limited to ½ inch w.c.

For elevated pressure systems, there are two operating pressures downstream of the gas source: the pressure set by the service regulator at the meter (usually 2 PSI) which leads to the pounds-to-inches regulator. The proper drop between the meter and the regulator is usually 1 PSI, allowing a ¾ PSI regulator drop downstream while providing the ¼ PSI (6-7 inches w.c.) required for appliances. Between the regulator and the appliances, sizing is calculated like low pressure systems with the exception that the allowable pressure drop is 3 inches w.c., typically sized for one appliance installed as a "home run" from the manifold.

### Low Pressure systems (Longest Length/Branch Method)

Sizing of the following systems is done by section. Each section is sized by determining the total gas load for all appliances and the maximum distance (longest length) over which a section delivers gas.

#### Example 1: Low Pressure System in a Series Arrangement (Figure 3.5)

In this installation, a small number of appliances are located near the natural gas source in one general area. The short runs and low appliance load make it ideal for a series arrangement.

#### Length of Runs:

A = 12' B = 8' C = 15'

Supply Pressure: 6" w.c.

Pressure Drop: 0.5" w.c.

**Step 1** Size Section A: Determine the longest run from the source that includes section A and the total gas load it must deliver.

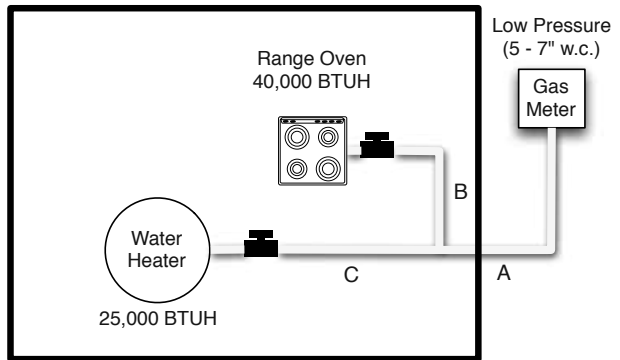

Figure 3.5 Low Pressure System—Series Arrangement

- Meter to range oven is 20 feet (A + B).
- Meter to water heater is 27 feet (A + C).
- Maximum load carried by section A is 65,000 BTUH (range + water heater). Convert to CFH by dividing by 1000 (for natural gas with a specific gravity of 0.60, 1 CFH = 1,000 BTUH). Maximum load is 65 CFH.
- Find the maximum capacity table that matches the system characteristics, in this case, natural gas with a minimum gas pressure of 6-7 inches w.c. and a pressure drop of 0.5 inches w.c. Table 7.1 is the correct table.
- Find the column in the length row that is greater than or equal to the longest run in the system. The longest run in this system is 27 feet and the table has columns for 25 and 30 feet. **Never round down when sizing.** The correct column is 30 feet.
- We then scan down the 30 feet column searching for a CFH value that is greater than or equal to the total load of the system. At 30 feet, ½" tubing has a maximum load of 42 CFH so it is not suitable for this system. The next size is ¾" with a maximum load of 116 CFH. ¾" tubing is the correct size for section A.

## Sizing and Configurations

**Step 2** Size Section B: Determine the length of the run from the meter to the range oven and the load delivered.

- The length from the meter to the range oven is 20 feet (A + B), and the load is 40 CFH (40,000 BTUH divided by 1000 CF per BTU).
- Consulting Table 7.1, we see that for a 20-foot run, ½" tubing will supply up to 51 CFH. The correct size tubing for section B is ½".

**Step 3** Size Section C: Determine the length of the run from the meter to the water heater and the load delivered.

- The length is 27 feet (A + C) and the load is 25 CFH (25,000 BTU).
- Consulting Table 7.1, we see that for a 30-foot run, ½" tubing will supply up to 42 CFH. The correct size for section C is ½".

### Example 2: Medium Pressure in a Parallel Arrangement

This system is typical of a single family residential installation with several appliances. As it is a medium-pressure system, the allowable pressure drop of 6 inches w.c. is greater than what would have been permissible in a low pressure system.

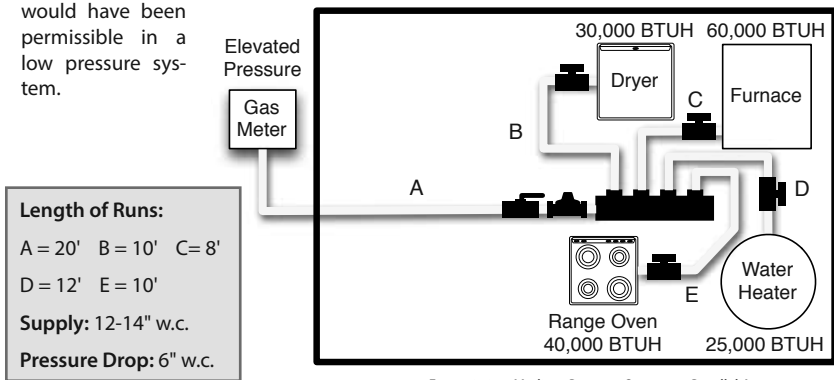

Figure 3.6 Medium Pressure System—Parallel Arrangement

**Step 1** Size Section A: Determine the longest run from the meter to any appliance:

- Meter (A) to water heater (D) is the longest run at 32 feet.
- The maximum load transported by section A is the total load of all appliances: dryer + furnace + water heater + range oven = 155,000 BTU = 155 CFH.
- Consulting Table 7.4, the columns nearest 32' are 30' and a 40'. Because we must use the length value that is greater than or equal to the measured run, the 40' column is correct. Our total load is 155 CFH, and ½" tubing has a total maximum capacity of 116 CFH at 40 feet, which is not enough for this system. ¾" Tubing has a maximum capacity of 398 CFH. ¾" Tubing is the correct size.

**Step 2** Size Section B: Determine the length from the meter to the dryer:

- A + B = 30 feet and the total load is the load of the dryer is 30,000 BTUH = 30 CFH.
- Table 7.4 shows that ½" tubing has a total load capacity of 133 CFH at 30 feet, exceeding the load of the dryer, so ½" tubing is the correct size.

**Step 3** Size Section C: Determine the length from the meter to the Furnace.

- A + C = 28 feet, and the total load is 60,000 BTUH = 60 CFH.
- Table 7.4 shows that ½" tubing has a total load of 133 CFH at 30 feet, so ½" tubing is the correct size.

**Step 4** Size Section D: Determine the length from the meter to the water heater.

- $A + D = 32$  feet, and the load of the water heater is 25,000 BTUH = 25 CFH.
- Table 7.4 shows that  $\frac{1}{2}$ " tubing has a total load capacity of 116 CFH at 40 feet, so  $\frac{1}{2}$ " tubing is the correct size.

**Step 5** Size Section E: Determine the length from the Range oven to the Furnace.

- $A + E = 30$  feet and the load of the furnace is 40,000 BTUH = 40 CFH.
- Table 7.4 shows that  $\frac{1}{2}$ " tubing, with a maximum capacity of 133 CFH, is correct.

## Elevated Pressure Systems

### Example 3: Elevated Pressure System in a Parallel Arrangement

In this example, an extended tubing run is required from the gas meter to the desired appliance locations. This scenario is common in single and multifamily locations. 2 PSI elevated systems are ideal for the long runs required in multifamily buildings that have a central gas meter bank.

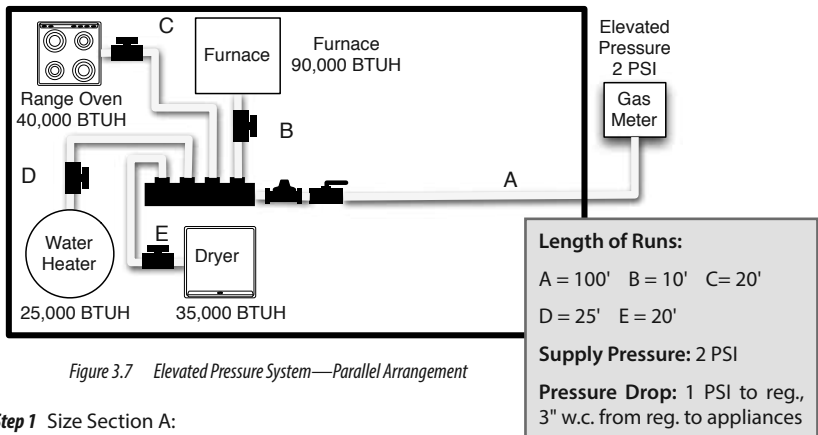

Figure 3.7 Elevated Pressure System—Parallel Arrangement

**Step 1** Size Section A:

- Maximum load = furnace + range oven + water heater + dryer = 190,000 BTU = 190 CFH and the distance to the regulator is 100 feet.
- Supply pressure is 2 PSI and allowable drop is 1 PSI. Table 7.5 is the correct table.
- Scanning the 100' column,  $\frac{1}{2}$ " tubing has a maximum capacity of 129 CFH which is not adequate.  $\frac{3}{4}$ " Tubing has a maximum capacity of 471 CFH. As this meets or exceeds our required capacity of 190 CFH,  $\frac{3}{4}$ " tubing is the correct size.

**Step 2** Size Sections B-E: From the regulator outlet, the system is supplying 8 inches w.c. with an allowable drop of 3 inches w.c. Table 7.3 is the correct table for this section of the system.

- Section B is 10 feet with an appliance load of 90 CFH for the furnace.  $\frac{1}{2}$ " Tubing has a maximum capacity of 160 CFH at 10 feet, so  $\frac{1}{2}$ " is the correct size.
- Section C is 20 feet with an appliance load of 40 CFH for the range oven.  $\frac{1}{2}$ " Tubing has a maximum capacity of 116 CFH at 20 feet, so  $\frac{1}{2}$ " is the correct size.
- Section D has a length of 25 feet with an appliance load of 25 CFH.  $\frac{1}{2}$ " Tubing has a maximum capacity of 104 CFH at 25 feet, so  $\frac{1}{2}$ " is the correct size.
- Section E has a length of 20 feet with an appliance load of 35 CFH.  $\frac{1}{2}$ " Tubing has a maximum capacity of 116 CFH at 20 feet, so  $\frac{1}{2}$ " is the correct size.

## Sizing and Configurations

### Example 4: Medium Pressure Parallel Arrangement with a Series Branch

This installation has a barbecue installed near the water heater. Given the number of appliances, a parallel arrangement was selected for the system, with a single run supplying the barbecue and the water heater in series.

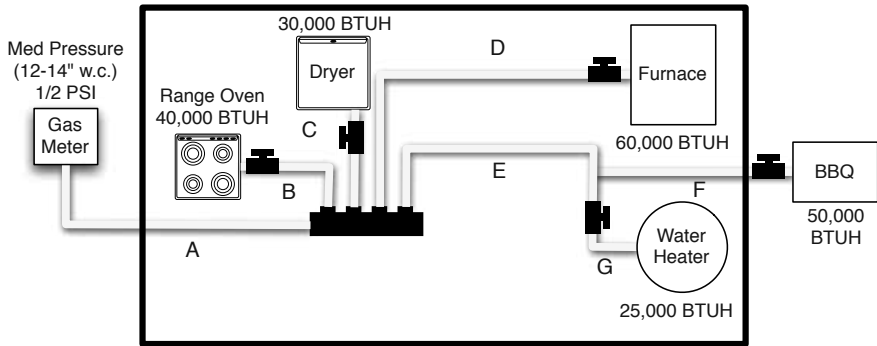

Figure 3.8 Medium Pressure System—Parallel Arrangement with Series Branch

**Step 1** Size Section A: Determine the length of the longest run (from gas meter to appliance) and total load required by the system.

- Total system load = range + dryer + furnace + water heater + BBQ = 205,000 BTUH = 205 CFH.
- Longest run is from meter to the BBQ:  $A + E + F = 60$  feet.
- Supply pressure is 12-14 inches w.c. ( $\frac{1}{2}$  PSI), and allowable pressure drop is 6 inches w.c., so Table 7.4 is the correct table.
- At a length of 60 feet,  $\frac{1}{2}$ " tubing can supply a maximum of 96 CFH. The system requires at least 205 CFH, so  $\frac{1}{2}$ " is too small.  $\frac{3}{4}$ " Tubing can supply a maximum of 329 CFH.  $\frac{3}{4}$ " Tubing is the correct size.

#### Length of Runs:

A = 25' B = 10' C = 10' D = 20'

E = 20' F = 15' G = 5'

Supply Pressure: 12-14" w.c.

Pressure Drop: 6" w.c.

**Step 2** Size Section B: Measure the length from the meter to the range to determine appropriate size.

- Total length is 35 feet (A + B), and appliance load is 40 CFH.
- 35 feet is not an option on the table, so we round up to 40 feet.  $\frac{1}{2}$ " Tubing has a maximum capacity of 116 CFH at 40 feet, so  $\frac{1}{2}$ " is the correct size for this run.

**Step 3** Size Section C: Determine the length from meter to the dryer:

- Total length is 35 feet (A + C) and appliance load is 30 CFH for the dryer.
- $\frac{1}{2}$ " Tubing has a maximum capacity of 116 CFH at 40 feet so  $\frac{1}{2}$ " is the correct size.

**Step 4** Size Section D: Determine the length from the meter to the furnace.

- Total Length is 45 feet (A + D) and appliance load is 60 CFH.
- $\frac{1}{2}$ " Tubing has a maximum capacity of 104 CFH at 50 feet so  $\frac{1}{2}$ " is the correct size.

**Step 5** Size Section E: Determine the longest length and total load for the section. As there are two appliances serviced by this run, it is calculated as a series layout like Example 1.

- Section E serves both the water heater and BBQ, so total load is 75 CFH.
- The longest length is from the meter to the BBQ ( $A + E + F$ ) = 60 feet.
- $\frac{1}{2}$ " Tubing has a maximum capacity of 96 CFH at 60 feet so  $\frac{1}{2}$ " is the correct size.

**Step 6** Size Section F: Determine the total length and load.

- The BBQ load is 50 CFH and the length is 60 feet (A + E + F).
- ½" Tubing has a maximum capacity of 96 CFH at 60 feet so ½" is the correct size.

**Step 7** Size Section G: Determine the total length and load.

- The water heater load is 25 CFH and the length is 50 feet (A + E + G).
- ½" Tubing has a maximum capacity of 104 CFH at 50 feet, so ½" is the correct size.

### Hybrid CSST & Black Iron Rigid Pipe Systems

In low and medium pressure systems with high loads and/or long runs, it can be advantageous to use both black steel pipe and HOME-FLEX® tubing to minimize pressure drops.

#### Sizing Hybrid HOME-FLEX® and Black Iron Systems

Proper sizing of hybrid HOME-FLEX® and rigid black steel pipe requires the use of the standard gas piping capacity tables used for black steel pipe (these can be found in many plumbing and mechanical codes as well as the *National Fuel Gas Code*) as well as the HOME-FLEX® capacity tables in this manual. For your convenience, a black steel capacity table for sizing is printed in Table 7.11 (p. 46) of this book.

#### Example 5: Low Pressure Hybrid System in a Series Arrangement

The system in Figure 3.9 is a commercial building with three unit heaters and a water heater. The source is standard low pressure with a 6 inch w.c. supply and 0.5 inch w.c. maximum allowable pressure drop. Sizing this system requires sizing the rigid black pipe section as well as the HOME-FLEX® CSST runs to the appliances.

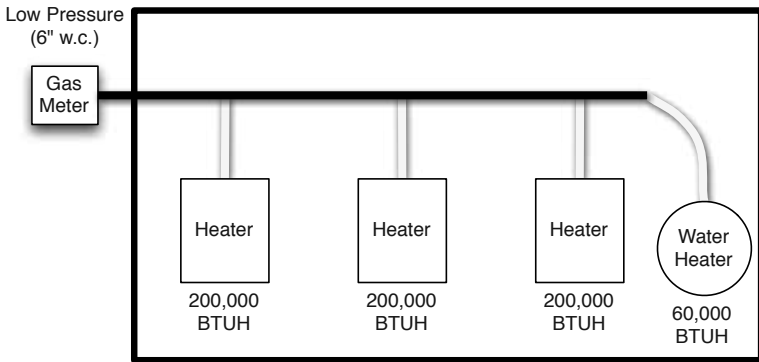

Figure 3.9 Low Pressure Hybrid System—Series Arrangement

**Step 1** Size the rigid black steel pipe: Determine length of longest run and total load.

- The longest run from the meter is A1 + A2 + A3 + A4 + E = 70 feet.
- Total load is 600,000 BTUH = 600 CFH. Consulting Table 7.11, at a 70 foot length, the diameter of black steel pipe that can supply 600 CFH or greater is 1½" with a maximum capacity of 750 CFH. The correct size for section A1 is 1½".
- To size section A2, we can reduce the load already carried by A1, in this case 200 CFH from the first heater. The length, however, remains 70 feet. Total load then is

#### Length of Runs:

A1 = 10' A2 = 20' A3 = 20' A4 = 5'  
B = 10' C = 10' D = 10' E = 15'

**Supply Pressure:** 6" w.c.

**Pressure Drop:** 0.5" w.c.

## Sizing and Configurations

400 CFH, which at 70 feet can be supplied by 1¼" pipe with a maximum capacity of 490 CFH. 1¼" pipe is the correct size for section A2.

- To size section A3, we can reduce the load by another 190 CFH to 210 CFH for the remaining heater and the water heater. At 70-feet, 1" pipe can supply a maximum of 240 CFH, which is sufficient for the run. 1" pipe is the correct size.
- To size section A4, the load is reduced to just the 60 CFH of the water heater. At 70-feet, ½" pipe can provide a maximum capacity of 61 CFH. ½" pipe is the correct size for section A4.

**Step 2** Size Section E: The length is the length of the black pipe plus the length of the HOME-FLEX® run = 70 feet, and total load is 60 CFH. Referencing Table 7.1, ¾" tubing provides a maximum capacity of 76 CFH at 70 feet. ¾" Tubing is the correct size for section E.

**Step 3** Size Section D: The length is the length of the black pipe up to the branch and the length of the HOME-FLEX® run =  $A1 + A2 + A3 + D = 60$  feet. Load is the load of the heater, 150 CFH. At 60 feet, 1" inch CSST can provide a maximum capacity of 156 CFH. 1" is the correct size.

**Step 4** Size Section C: The length is 40 feet and total load is 190 CFH. At 40 feet, 1" tubing provides a maximum of 195 CFH. 1" Tubing is the correct size.

**Step 5** Size Section B: The length is 20 feet and total load is 200 CFH. At 20 feet, 1" tubing is required to provide at least 200 CFH, with a maximum capacity of 288 CFH.

# Chapter 4: Installation Practices

## 4.1 General Practices

HOME-FLEX® CSST flexible gas piping material must be installed by a Qualified Installer who has been certified in the use of the HOME-FLEX® gas piping system. Installers must meet applicable qualifications set forth by the state and/or local administrative authorities which enforce the plumbing, mechanical, electrical and/or building codes at the locale where the gas piping is to be installed. A HOME-FLEX® Qualified Installer Card is required to install HOME-FLEX® CSST. For more information on certification please see Section 1.1 on page 1.

All HOME-FLEX® tubing and components should be stored such that they are not damaged or exposed to water, debris, or chemicals. During the installation and construction process, care must be taken to ensure that exposed tubing is not damaged.

Only components provided or specified by Valencia Pipe Company are to be used as part of the HOME-FLEX® gas piping system. Do not use HOME-FLEX® tubing or HOME-FLEX® fittings with the tubing or fittings of another CSST brand or manufacturer. Connections between different brands of CSST may be made through the use of standard malleable iron fittings.

During installation, any open ends of HOME-FLEX® tubing are to be temporarily plugged, taped, or otherwise sealed to prevent the entrance of dirt, dust, or other debris into the gas system.

Contact with sharp objects or substances harmful to the CSST or yellow protective jacket must be avoided. The protective jacket should be kept in place as much as possible to protect the tubing from corrosive threats. Contact with chemicals containing chlorides or ammonia (such as fluxes or acid based cleaners) must be followed by a thorough rinse and dry. Only non-corrosive leak detection fluids should be used when testing for leaks.

Take care to avoid unnecessary stress or strain on HOME-FLEX® tubing and fittings. While the ability to bend HOME-FLEX® tubing is a main feature in its installation convenience, there is a minimum bend radius that should never be exceeded as it could damage the tubing. Multiple tight bends can restrict gas flow, leading to the increased pressure drop. HOME-FLEX® tubing should never be stretched, kinked, or twisted. Bends should be of as large a radius as possible to maximize gas flow and reduce risk of damage to CSST. Figure 4.1 demonstrates how the radius of a bend is calculated. Table 4.1 lists the absolute and recommended minimum bend radii for HOME-FLEX® tubing.

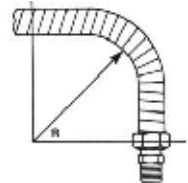

Figure 4.1 Bend Radius (R)

Tubing Size	Absolute Minimum Bend Radius (R)	Recommended Min. Bend Radius (R)
½" (13 mm)	1¼" (32 mm)	3" (75 mm)
¾" (19 mm)	1⅝" (42 mm)	
1" (25 mm)	2" (51 mm)	5" (125 mm)

HOME-FLEX® tubing must be supported with nonmetallic pipe straps, bands or hangers suitable for the size and weight of the tubing, at intervals not to exceed those shown in Table 4.2. Tubing should not be supported by, or run near, conductive metallic systems such as metallic appliance vents, ducting, or piping. Electrical cables must be avoided and cannot be used as supports. Tubing is considered supported if it passes through or over a structural component of the building.

## Installation Practices

Tubing Size	Horizontal Support Spacing	Vertical Support Spacing
½" (13 mm)	6 ft.	10 ft.
¾" (19 mm)	8 ft. (USA) 6 ft. (CAN)	
1" (25 mm)		

### 4.2 Fitting Assembly

HOME-FLEX® fittings achieve seal by compressing the tubing into the gasket (Figure 4.2). It is critical that the cut end of the tubing is clean of any burrs or jagged edges, and that there is no debris on the tubing or gasket. A seal is achieved with a good deal of force (Table 4.3). In the absence of a torque wrench, the general guideline is to tighten with two wrenches (one holding the fitting in place, the other turning the flange nut counter-clockwise) until the nut will no longer turn and only 2-3 threads are showing.

Tubing Size	Torque Value
½" (13 mm)	62 lb-ft
¾" (19 mm)	62 lb-ft
1" (25 mm)	74 lb-ft

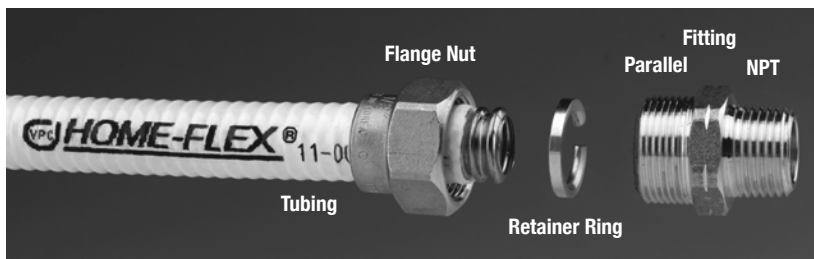

Figure 4.2 (1) Gasket in Fitting Before Assembly, (2) After Assembly (note groove in gasket), and (3) Compressed Tubing

**Note: The gasket can only be used once.** Once it has been compressed (Figure 4.2) during the assembly process, it cannot be reused. A new gasket must be installed in the fitting.

**Note: The o-ring does not function as a gas sealing mechanism in the fitting assembly.** The o-ring keeps moisture and corrosives out of the area between the tubing and fitting flange. If the o-ring is misplaced and there is risk of outside moisture or contaminants entering the assembly, wrap with the assembly with self-bonding silicone tape from the tubing jacket to the end of the nut flange.

### Male, Female, Union and Tee Fitting Assembly Overview





## Male, Female, Union and Tee Fitting Assembly

### Step 1 Cut HOME-FLEX® tubing to length

Using a stainless steel rated tube cutter, cut the HOME-FLEX® tubing to the desired length, leaving at least 1 extra inch for placement of the fitting. Cut in the valley of the tubing and clean any burrs or jagged edges. Cut in full circular strokes in one direction, tightening gradually after each rotation. Be careful to not overtighten the roller as it could flatten the HOME-FLEX® tubing.



### Step 2 Remove tubing jacket to prepare for fitting assembly

Using a utility knife, strip the yellow pipe jacket back 2 valleys from the end of the tubing.

**DO NOT USE A TUBE CUTTER FOR THIS TASK AS IT COULD DAMAGE THE TUBING.**

### Step 3 Place flange nut over HOME-FLEX® tubing

Slide the HOME-FLEX® flange nut over the tubing with the threaded end pointing toward the end of the tubing. The flange should cover the yellow tubing jacket.



### Step 4 Place retainer ring on HOME-FLEX® tubing

Place the retainer ring in the first valley of the tubing. Being careful to not dent the tubing, clamp the ring in place by applying gentle pressure 360° around the ring. It should fit tightly and not easily spin around the tubing.

## Installation Practices

### Male, Female, Union and Tee Fitting Assembly

#### **Step 5** Install HOME-FLEX® fitting in destination (manifold, pipe system, fixed appliance, etc.)

Make sure that the gasket inside the HOME-FLEX® fitting is secure on the socket. Apply a pipe sealant to the tapered (NPT) thread of the fitting and install it in the gas system.



#### **Step 6** Attach flange nut to the installed HOME-FLEX® fitting

Place the HOME-FLEX® flange nut onto the installed fitting. Hand tighten the fitting assembly from the nut-end being sure that only the nut turns (the fitting and tubing should not turn). Then tighten to the recommended torque value in Table 4.3 (p. 20) using a second wrench to hold the fitting in place (generally, tighten with force until the nut will no longer turn).

DO NOT use sealant on the parallel thread (gasket side) of the socket.



### Termination Fitting Assembly Overview (Parts 11-464-XXX)

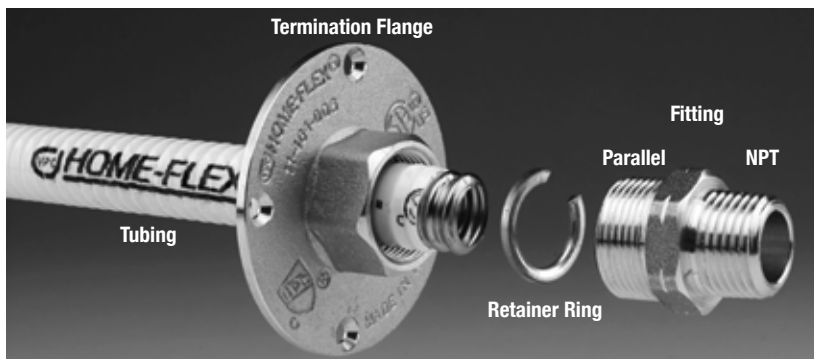

## Termination Fitting Assembly (Parts 11-464-XXX)

### Step 1 Cut HOME-FLEX® tubing to length

Route CSST through structure to the desired location of the termination flange. Bend tubing as required so it exits the structure in desired direction of the termination plate. Cut the excess CSST so about 2" of tubing extends beyond the wall.



### Step 2 Remove tubing jacket to prepare for fitting assembly

Using a utility knife, strip the yellow tubing jacket back 2 valleys from the end of the tubing. Also remove the yellow warning label from the fitting assembly.

DO NOT use a tube cutter.

### Step 3 Place flange nut over HOME-FLEX® tubing

Slide the termination flange over the tubing with the threaded end pointing toward the end of the tubing.

DO NOT SECURE THE FLANGE.



### Step 4 Place retainer ring on HOME-FLEX® tubing

Place the retainer ring in the first valley of the tubing. Being careful to not dent the tubing, clamp the retainer ring in place by applying gentle pressure 360° around the ring. It should fit tightly and not easily spin around the tubing.

## Termination Fitting Assembly (Parts 11-464-XXX)

### Step 5 Place fitting and assemble flange

Pull termination flange toward end of tubing so it catches on the retainer ring, ensuring that the retainer ring and flange are flush. The base of the flange should be parallel with tubing corrugation. **DO NOT** use sealant tape or pipe dope on parallel threads between flange and fitting.

Hold the fitting on the NPT thread and attach to termination flange by turning the flange counter-clockwise onto the fitting, being sure the tubing and flange do not move. Hand tighten.



### Step 6 Tighten the flange assembly

Complete tightening with two wrenches to suggested torque values in Table 4.3 (p. 20), holding the fitting fixed with one wrench while turning the flange counter-clockwise with the other, being sure that the tubing does not rotate. Push the assembly back flush to the wall and secure with screws.

## Troubleshooting Fitting Connections

**Step 1** Gradually tighten fitting until leak stops.

**Step 2** If leak does not stop after reaching maximum torque, stop, open the assembly and check for:

- Proper fitting assembly. Make sure the gasket is installed in the base of the parallel thread of the fitting. If it was not, install the gasket, repeat assembly steps, and test for leaks again. **Gaskets cannot be reused: if it was installed, replace it with a new gasket and continue to step 2b.**
- Check for any obstructing material (dirt, shavings, jacket, etc.) in assembly. Remove material and reassemble, checking for leaks again.
- Integrity of assembly pieces. If the retainer ring or the gasket are cracked, misshapen or otherwise damaged, replace them and repeat assembly.

**Note:** **DO NOT** use sealing solution on parallel thread (gasket end) of fitting assembly. **Gaskets cannot be reused, and must be replaced if fitting assembly is disassembled.**

## 4.3 Routing

### General Routing Practices

Routing requirements for CSST flexible gas pipe can vary by locality. Be sure to confirm the requirements of the administrative authority for the location where HOME-FLEX® is to be installed before installing HOME-FLEX®. In general, HOME-FLEX® can be routed:

- Beneath, through, and along side floor and ceiling joists. This is typical for residential and commercial installations with basements or multi-floor routing.

- Inside hollow interior wall cavities. Routing inside wall cavities is preferred for vertical sections of tubing. Horizontal runs through wall cavities should be avoided to minimize the need for striker protection from puncture hazards.
- Through approved conduit underground or under building slabs. Under no circumstances is HOME-FLEX® to be routed underground or under slab unless it is routed within a nonmetallic water-tight conduit that is at least ½" larger than the outer diameter (OD) of the CSST tubing. Fittings and joints are not permissible in such runs—the run must be one unbroken line of tubing. Runs underneath slabs must be sleeved and vented per local codes.
- Outdoors. When installed outdoors, the yellow jacketing of HOME-FLEX® must be intact along the entire run. Any areas of exposed tubing are to be wrapped with self-bonding silicone tape or sleeved to prevent threats from acids or chlorides.
- Along the perimeter of a building. Care must be taken to protect HOME-FLEX® from mechanical damage when installed along the exterior of a building. If installed within 6 feet of the ground, HOME-FLEX® tubing must be routed within a conduit or chase. If installed in a location where the tubing will not be subject to possible mechanical damage, a conduit is not required, but is recommended.

Tubing should not be supported by, or run near, conductive metallic systems such as metallic appliance vents, ducting, or piping.

Careful consideration should be given to route HOME-FLEX® tubing in areas where mechanical damage is least likely.

**Clearance Holes and Notching**

Clearance holes for routing tubing through studs, joists, plates, etc. must have a diameter at least ½" larger than the outside diameter of the tubing (Table 4.3). Local codes pertaining to structural members must be followed when drilling clearance holes—no structural members should be compromised, weakened or impaired by cutting, notching, drilling, or otherwise alternating the member.

Tubing Size	Drill Hole Size
½" (13 mm)	1¾" (35 mm)
¾" (19 mm)	1½" (38 mm)
1" (25 mm)	1¾" (45 mm)

**Routing through holes in joists, rafters or similar wood structures**

When HOME-FLEX® tubing is installed through bored holes in joists, rafters, or other wood structures, the holes should be bored such that the edge of the hole is at least 2 inches from the nearest edge of the wood structure (Figure 4.3). If this criterion can't be met, the tubing must be protected by a striker plate of suitable size installed in accordance with Section 4.4 (p. 28). The diameter of the hole should be no more than 1/3 the depth of the wood structure.

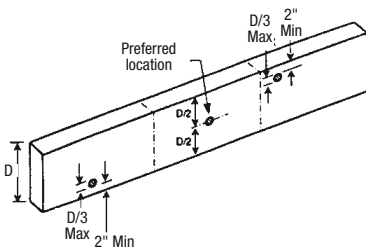

Figure 4.3 Holes in Wood Structures

**Holes and Cuts in Top and Sole Plates**

Holes bored through top plates, top frame members and sole plates should not exceed 50% of the width of the structure, and should be in the center of the structure. If a sole or plate is to be cut for the routing of HOME-FLEX® tubing, the width of the cut should be ½" greater than the outside diameter of the tubing and no greater than 2 inches (Figure 4.4). Tubing must be protected with striker plates in accordance with Section 4.4.

## Installation Practices

### Routing through vertical wall framing

Requirements for boring through vertical members of wall framing differ depending on whether the member is bearing or not. For non-bearing members (Figure 4.5), the size of the hole should be no larger than 60% of the width of the member. For bearing members, the size of such hole should be no more than 40% of the member. (Figure 4.6)

### Routing through metallic surfaces

When installing HOME-FLEX® through galvanized steel studs, plastic grommets (often supplied by the stud manufacturer) should be used to reduce potential damage to the yellow jacket of the HOME-FLEX® tubing. When installing through

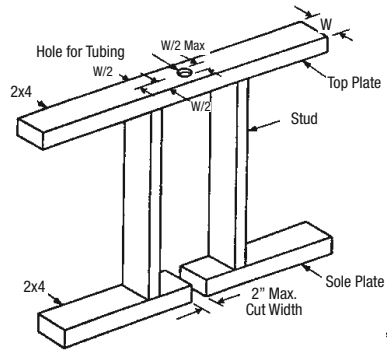

Figure 4.4 Holes and Cuts in Top and Sole Plates

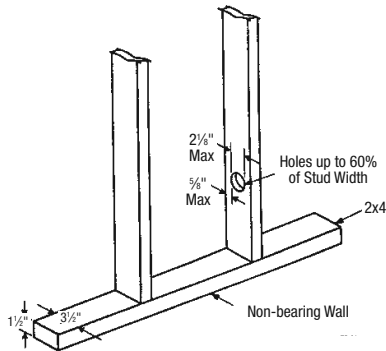

Figure 4.5 Holes in Non-Bearing Walls

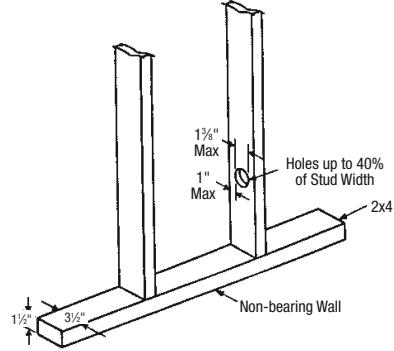

Figure 4.6 Holes in Bearing Walls

holes in other metallic members, the tubing must be similarly protected from contact with the member to prevent mechanical wear on the yellow jacket and tubing. Acceptable means of protection include: rubber grommets, bushings, HOME-FLEX® Flexible Protective Conduit, PVC tape, thermal contraction sleeve material, or a minimum of four wraps of 10 mil duct tape.

### Concealed Locations for Fittings

The HOME-FLEX® mechanical attachment fittings have been tested and are listed per the requirements of ANSI LC1 and CSA 6.26 Standard (USA and Canada). This specification provides test requirements which certify fittings for concealed installations and connections to appliances where concealing the fittings is the only practical alternative

These guidelines address some of the known situations which may require the use of a concealed fitting. While accessibility of fittings is always preferred, there are some situations where concealing the fittings is the only practical option. This guide cannot address all applications of concealed fittings, but instead provides general instructions to demonstrate the principles which apply to fittings listed for installation in concealed locations (*National Fuel Gas Code*, NFPA 54 Chapter 7).

NOTE: Manifold stations which are composed of multiport manifold(s), shut off valve, and pressure regulator **shall not be** installed in concealed locations regardless of the qualifications of tubing fittings.

### New Installations

HOME-FLEX® can be connected to steel piping systems through threaded pipe connections. This can be a sub-out run to an appliance connection, be outdoors to a meter, etc.

HOME-FLEX® connections to fireplace key valves can be located in a concealed location, provided that accessibility is not readily provided.

When multiple outlets are supplied from a single tubing run (like in a series arrangement), each downstream outlet branch can be connected to the main run using a tee fitting which can be located in a concealed location. (Figure 4.7)

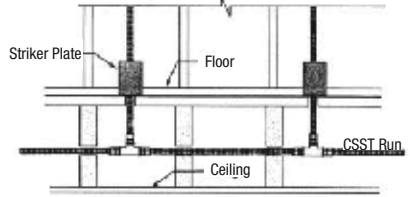

Figure 4.7 Multiple Outlets Along Main CSST Run

#### Modifications to Existing Systems

**New Ceilings:** HOME-FLEX® fittings originally installed in an unfinished ceiling location can be concealed in the event that a ceiling is installed at a later date.

**Extensions to existing tubing runs:** A concealed run of tubing can be extended with a new pipe run to feed another appliance location, so long as there is sufficient capacity to supply both appliances simultaneously. If an accessible location for the modification is not available, the existing run can be modified with a tee fitting, resulting in a concealed fitting (Figure 4.8)

**Repairs to existing tubing runs:** Damaged tubing runs should be repaired in accordance with Section 5.2 of this guide. The repair can result in a line splice that may be located in a concealed location.

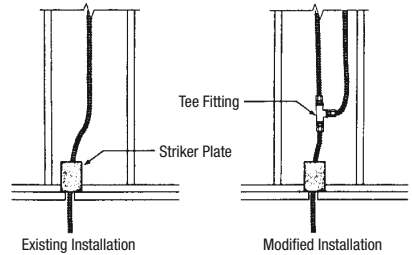

Figure 4.8 Extension of Existing Tubing Run

#### Outdoor Installation

ANSI LC1-CSA 6-26 contains test requirements determining suitability for exposure of CSST to outdoor environments. HOME-FLEX® is certified to this standard and is suitable for outdoor installations. The HOME-FLEX® jacket is UV resistant and able to withstand exposure to sunlight for a limited time. Avoid prolonged exposure to direct sunlight to attain longevity of the jacket. When this is not possible, tubing should be routed in a non-metallic sleeve or wrapped in self-bonding silicone tape.

When installed outdoors, the yellow jacketing of HOME-FLEX® must be intact along the entire run. Any areas of tubing not covered by the jacket are to be wrapped with self-bonding silicone tape or sleeved to prevent damage from acids and chlorides.

If HOME-FLEX® is installed in the equipment room of a swimming pool or hot tub, or otherwise exposed to a corrosive environment which could be harmful to the tubing, the tubing shall be installed in a protective device, and any exposed portions of the stainless steel tubing should be wrapped with self-bonding silicone tape, beginning on the jacket and ending on the nut of the HOME-FLEX® fitting.

Care must be taken to protect HOME-FLEX® from mechanical damage when installed along the exterior of a building. If installed within 6 feet of the ground, HOME-FLEX® tubing must be routed within a conduit or chase. If installed in a location where the tubing will not be subject to possible mechanical damage, a conduit is not required, but is recommended.

HOME-FLEX® should never be buried directly underground. To route HOME-FLEX® tubing underground, it must be protected within a nonmetallic water-tight conduit that is at least ½" larger than the outer diameter (OD) of the CSST tubing. Fittings and joints are not permissible in such runs—the run must be one unbroken line of tubing. Runs underneath slabs must be sleeved and vented per local codes. (See Section 4.9, "Underground Installations" on page 35)

**Note:** If installed underneath mobile homes or in crawl spaces, HOME-FLEX® should be installed in accordance with the above *Outdoor Installation Issues* section.

## 4.4 Protection

Protection is required when HOME-FLEX® tubing is concealed, constrained, and within 3 inches of a potential threat.

HOME-FLEX® flexible gas tubing must be adequately protected wherever it is at risk of damage from puncture, shearing, crushing, or other physical threats. Tubing is to be protected at support points, and when passing through structural members of the building such as studs, joists, and plates as outlined in this section. If the tubing requires protection, the measures in this section should be followed.

### Striker Plates

Shielding devices (striker plates) are used to protect the HOME-FLEX® tubing from puncture threats such as drill bits, nails, screws, etc. Such devices are required when the tubing is concealed and is constrained such that the tubing would not be able to move if struck by a puncture threat.

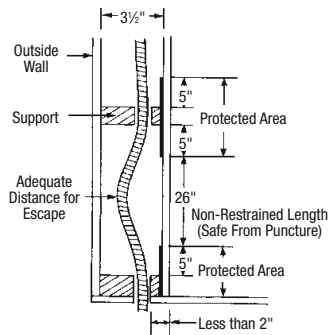

Figure 4.9 Elevated View of Unsupported Horizontal Tubing Run

- At support points and areas of possible penetration less than 2 inches away from any edge of a stud, joist, plate, etc., shielding is required both at the area of support and within 5 inches of each side. (Figure 4.9)
- At support points and points of possible penetration 2-3 inches from any edge of stud, joist plate, or other member, shielding is required throughout the area of support. (Figure 4.10)

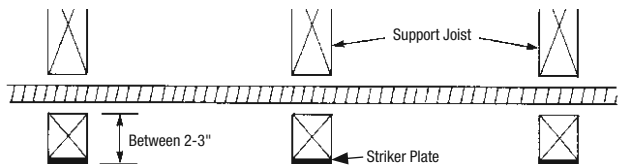

Figure 4.10 Shielding at Support Area When Penetration is 2-3 inches from Edge

- At termination points using the HOME-FLEX® termination flange, HOME-FLEX® Flexible Protective Conduit should be installed to protect the CSST in the area between the striker plates and the outlet. (Figure 4.11)
- For tubing routed horizontally between studs, striker plates should be installed at each stud, and Flexible Protective Conduit, or other approved conduit, should be installed across the entire length of the run.
- If striker plates can't reasonably be installed (like between floors with enclosed joist areas or installations when walls are already in place), schedule 40 steel pipe has been found acceptable by CSA International for puncture protection. Steel pipe must have an inner diameter at least 1/2 inch larger than the outer diameter of the HOME-FLEX® tubing (Table 4.4). Protection must extend 5 inches beyond the penetration of the structural members. A 12 inch pipe length is acceptable for penetration of a single stud. Despite this approval, the use of striker plates is recommended whenever possible.

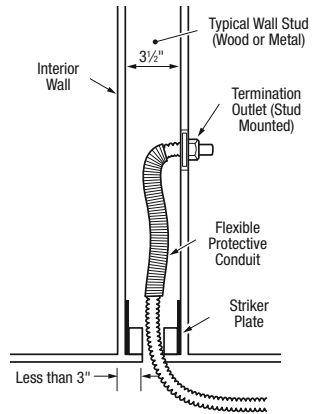

Figure 4.11 Use of Flexible Protective Conduit

HOME-FLEX® Size	Sch 40 Steel Pipe Size
1/2"	1 1/4"
3/4"	1 1/2"
1"	1 3/4"



### Avoiding Puncture Threats

The best way to protect from puncture threats (and potentially speed your installation) is to route tubing in areas of the structures where no added protection is necessary. The guidelines below will help the installer route HOME-FLEX® tubing in areas where secondary puncture protection isn't required:

1. Support tubing such that it is more than 3 inches away from any outside edge of a stud, joist, plate, etc., or wall surface. (See Figure 4.12 compared to Figure 4.10)
2. In non-restrained installations, make sure that the tubing can move at least 3 inches from the direction of potential penetration.
3. Tubing supported under joists in basements or crawl spaces does not require added protection so long as it is not concealed by wallboard or ceilings and is at least 3" away from puncture threats through floors or ceilings.
4. Added protection is not necessary in unfinished garage walls where the tubing is clearly exposed so long as puncture threats do not exist from the outside wall.

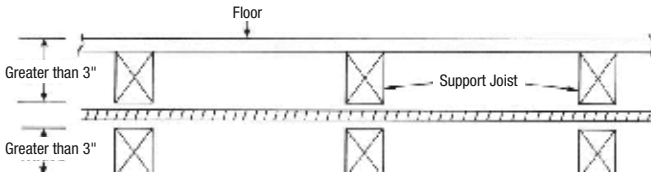

Figure 4.12 Penetration Point Greater than 3" from Edge of Stud, Joist, Plate, etc.

### Through-Wall Penetration

HOME-FLEX® tubing and its polyethylene jacket have been tested to the flame spread and smoke density requirements of ASTM E84 and meets AGA and ANSI LC-1 limits imposed for this criteria. HOME-FLEX® is classified as NFPA Class A/IBC Class A with a flame spread value of 0 and a smoke density value of 80. Other requirements for fire rated resistive constructions may be imposed by local codes. The Qualified Installer must meet local building codes pertaining to flame and smoke density regulations for nonmetallic materials at all times.

## 4.5 Meter connections

Natural gas meters are generally structurally supported independent of the building structure and piping system. When the gas meter is independently supported, HOME-FLEX® can, in some localities, be used to connect the meter to the building gas system. If the gas meter is not supported independent of the building structure or gas piping system, HOME-FLEX® tubing cannot be used to connect directly to the meter.

### Connection by Special Termination Fitting

Do not use HOME-FLEX® CSST as a direct connection if the meter must be supported by the piping system. If the meter is supported by the building structure, common practice is to route the CSST system to a termination flange mounted to the exterior of the building, and to connect the meter to the termination flange with rigid pipe. Alternatively, rigid pipe can be used to penetrate the building, with an attachment to HOME-FLEX® inside the structure. (Figure 4.13)

### Direct Connection

If a direct connection from HOME-FLEX® to an independently supported gas meter is permitted by the local utility, the connection should include an extra 3-6" of length to allow for building settling and meter movement. Exposed sections of CSST are to be wrapped with self-bonding silicone tape, especially if the building is of masonry construction. For direct connections through masonry construction, a PVC sleeve is required, and also recommended for wood frame construction. (Figure 4.14)

## Installation Practices

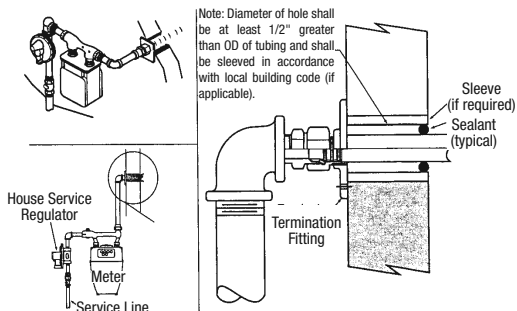

Figure 4.13 Connection to Building supported Meter

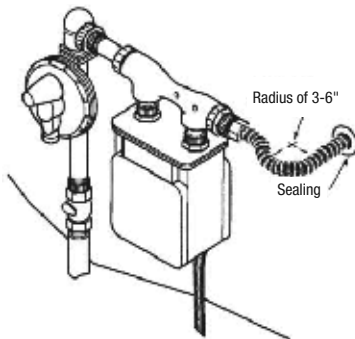

Figure 4.14 Independently Supported Meter

Note: Check with the local servicing utility prior to directly connecting HOME-FLEX® to the gas meter as utilities regulate connections to meter attachments.

## 4.6 Appliance connections

### Termination Fittings with Appliance Connectors

The HOME-FLEX® termination flange fitting is designed to service moveable appliances and quick-connect devices at floor and hallow wall piping outlets (Figure 4.16) in combination with a HOME-FLEX® Flexible Appliance Connector or similar approved device. The termination outlet minimizes the need for concealed fittings and makes the installation of gas connections for moveable appliances easy. The flange plate should be securely fastened in place during rough-in of the structure. It may be attached to a brace spanning between wall studs or directly to the floor.

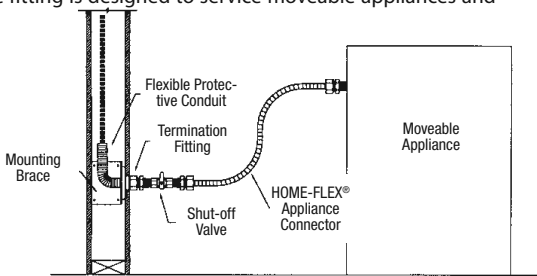

Figure 4.16 HOME-FLEX® Connection to Moveable Gas Appliance

As an alternative to the special termination flange, a termination can be made with rigid pipe connected to the main HOME-FLEX® system. The rigid stub-out must be fastened to the wall or floor using a pipe flange or other rigid mounting object.

Connections made between HOME-FLEX® and moveable appliances must be made with a HOME-FLEX® Flexible Appliance Connector, or similar approved device.

**Direct connections between HOME-FLEX® CSST and moveable appliances are not allowed.**

### Direct Connection

In most localities, fixed appliances may be directly connected to HOME-FLEX® flexible gas piping systems. When located in a secure dedicated place,

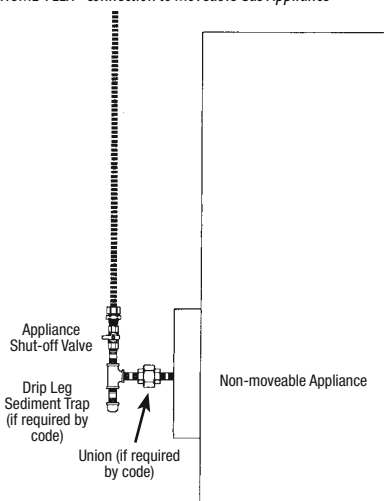

Figure 4.15 Direct Connection to Fixed Appliance

like an attic or garage, the gas piping can be connected directly to the appliance shut-off valve without installing a special termination flange or flexible appliance connector. (Figure 4.15)

### Pad-Mounted Equipment

Gas equipment like pool heaters, generators, heat pumps, and gas air conditioners that are mounted on concrete pads should connect to the HOME-FLEX® system at a termination fitting with either black steel pipe or an approved outdoor appliance connector. Direct connection of HOME-FLEX® to pad-mounted equipment is allowed when the CSST is securely supported and protected from physical damage, so long as such practice is permissible by local and state codes. Any exposed tubing should be wrapped with self-bonding silicone tape, sealing the fitting connection.

### Roof Top Equipment

Special mechanical protection of HOME-FLEX® tubing is not required for roof-mounted equipment unless the tubing may be subject to physical or environmental damage in the location. It is recommended that the tubing be covered to protect it from the elements.

HOME-FLEX® tubing should penetrate the roof within 6 feet of the equipment location, whenever possible. Long runs of tubing on the roof should be supported with nonmetallic blocks at the intervals specific in Table 4.2, and raised above the roof at the height dictated by local code. (Figure 4.17)

In addition to nonmetallic blocks, HOME-FLEX® can be supported with a strut or channel running from block to block. This provides a secure, damage resistant track for the CSST and allows for the block spacing to be set at every 8 feet. The channel run should be a 1 $\frac{3}{16}$ " galvanized shallow channel with splice plates at joints and bends. HOME-FLEX® tubing should be firmly attached to each block with metallic clamps designed for the strut, or other appropriate fastener. Black UV resistant cable ties can be used at intermediate points to ease the rolling out of HOME-FLEX®. Blocks should be attached to the roof surface in compliance with the roofing manufacturer's instructions. (Figure 4.18)

Any HOME-FLEX® tubing run vertically up the side of a building or on a rooftop must be protected in accordance with "Outdoor Installation Issues" in Section 4.3.

### Outdoor Appliances: Barbecue Grills, Gaslights, and Heaters

As with movable indoor appliances, movable barbecue grills, heaters, and other appliances should not be directly attached to HOME-FLEX® CSST. An approved outdoor appliance connector should be used to make the connection from the appliance to the piping system at a special termination flange, a steel nipple, or a quick-connect device as described in Section 2.6 (p. 6). Always follow manufacturer's installation instructions. (Figure 4.19)

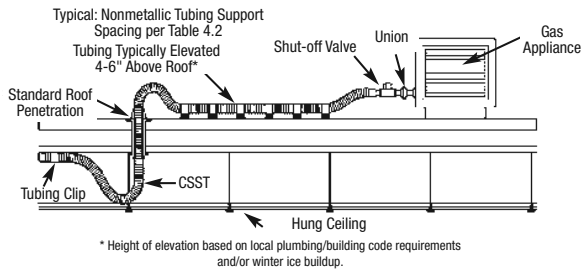

Figure 4.17 Roof Top Equipment Installation

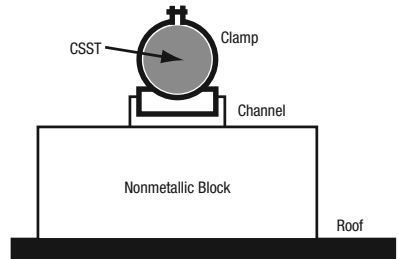

Figure 4.18 Rooftop Support with Strut

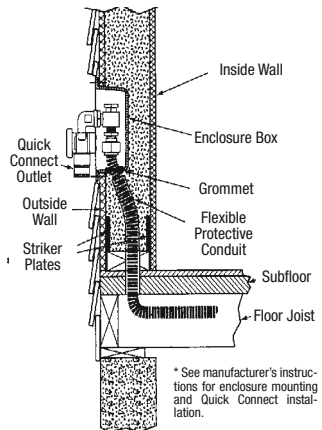

Figure 4.19 Quick Connect Outlet

## Installation Practices

Diameter of hole shall be at least 1/2 in. greater than OD of tubing and shall be sleeved and sealed in accordance with local building code (if applicable)

Connection of CSST to grill controls/shut-off valve shall be in accordance with the manufacturer's instructions

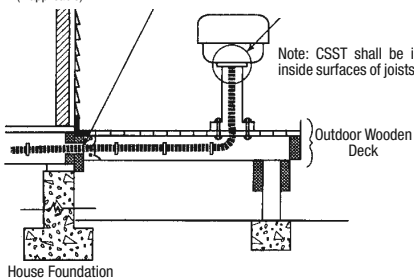

Figure 4.21 Fixed Outdoor Appliance (Deck Mounted)

Non-movable outdoor appliances, such as fixed barbecues, gas lights, or heaters can be directly connected with HOME-FLEX® so long as such connections are permissible by local code. On a deck, the outdoor portion of the tubing run must be supported against the sides of joists. If the deck elevation is below the building foundation, exposed tubing must be routed through a protective water-tight nonmetallic conduit. Underground tubing runs must follow the guidelines in Section 4.9 (p. 35). The exposed end of conduit must be sealed to prevent foreign objects (dirt, water, pests, etc.) from entering. (Figure 4.21 and Figure 4.20)

Note: Connection of CSST to equipment gas controls shall be in accordance with the manufacturer's instructions

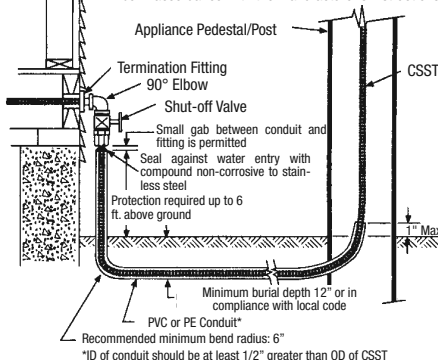

Figure 4.20 Fixed Outdoor Appliance (Underground Routing)

## Fireplace Installations

Most gas fireplaces and gas logs are considered fixed appliances which can be directly connected with HOME-FLEX® without a special termination flange (ANSI Z24.50). Direct delivery of gas is approved to the key valve for decorative and heat generating fireplaces and for gas logs used in masonry and pre-fabricated fireplaces. (Figure 4.22)

DO NOT use HOME-FLEX® CSST to connect gas log lighter or gas wands for use in all-fuel (wood burning) fireplaces. For gas log lighter installations in all-fuel fireplaces, HOME-FLEX® must be terminated at the key valve or another location outside the fireplace. The final attachment to the lighter should be made using black steel pipe.

Should HOME-FLEX® need to be installed through masonry materials in the fireplace construction, the yellow jacket should remain intact and the HOME-FLEX® tubing should be routed through a nonmetallic sleeve appropriate for the application. Sleeves are not required for routing through ceramic liner in heat generating fireplaces. Spaces between the jacket and penetration at interior and/or exterior locations can be caulked. The jacket can be removed inside the firebox.

Attachment to the HOME-FLEX® system is usually made at the fireplace shut-off valve, often located in the control area beneath the burner unit or at the side of the log set. HOME-FLEX®

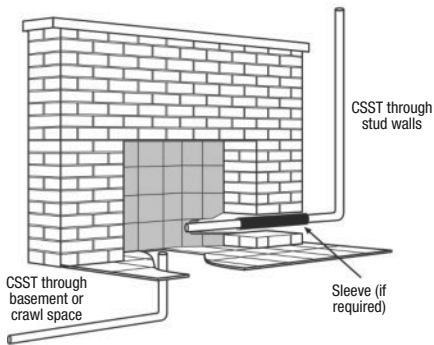

Figure 4.22 Routing to Masonry Fireplace

can be run into the lower control area without removal of the polyethylene jacket. If the fire-place is vented, it is suggested to remove the yellow jacketing inside the fire box to prevent direct flame contact with the jacket.

If installing HOME-FLEX® through sheet metal enclosures (as commonly used for decorative fireplaces), it is recommended to leave the protective yellow jacketing in place through the penetration. HOME-FLEX® should be secured to the building structure outside the fireplace to limit motion after installation. Installations that may lead to abrasion of HOME-FLEX®, such as vibration from a fan in the fireplace assembly, require a short piece of Flexible Protective Conduit or PVC pipe to insulate the HOME-FLEX® from the enclosure.

## 4.7 Manifold Stations

In elevated pressure systems (typically installed in a parallel arrangement), it is recommended to use a central manifold and regulator station to take best advantage of regulator capacity (Figure 4.24). Stainless steel manifolds are available from Valencia Pipe Company or can be assembled through the use of rigid black steel pipe and fabricated tee manifolds. It is recommended that the station be located near the appliance(s) with the highest load in the system to allow for shorter runs to those appliances.

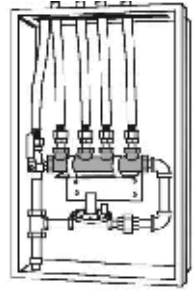

Figure 4.23 Gas Load Center

The manifold and regulator station **MUST** be located in an accessible location to maintain access to the shut-off valves and regulator. The station may be housed in a gas load center enclosure (Figure 4.23). Optional shut-off valves can be mounted on the manifold to control each appliance run in addition to the main line shut-off valve.

Subject to local code approval, manifolds may be concealed when used in low pressure systems, or when the manifold is installed in a location removed from the regulator. However, accessible locations are strongly recommended.

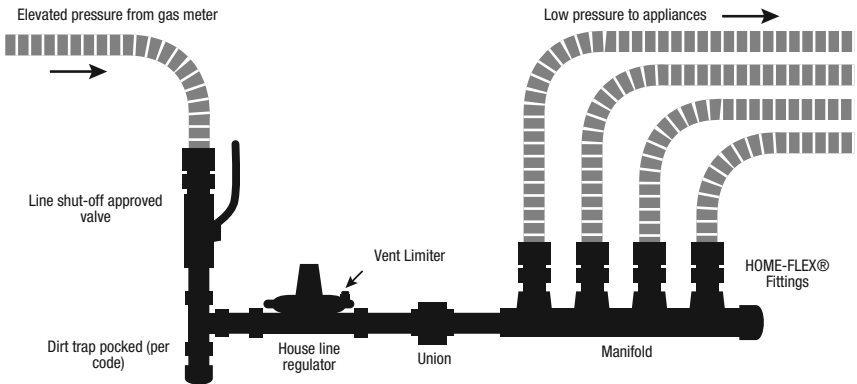

Figure 4.24 Example of Manifold Station Layout

## 4.8 Pressure Regulators

### Installation Requirements

A HOME-FLEX® gas piping system used with inlet gas pressures in excess of  $\frac{1}{2}$  PSI, but servicing appliances rated for a maximum of  $\frac{1}{2}$  PSI, must contain a pounds-to-inches regulator to limit the downstream pressure to no more than  $\frac{1}{2}$  PSI. Gas pressure regulators must comply with a nationally recognized standard for pressure regulators such as ANSI Z21.80/CSA 6.22. Regulators must also conform to the following:

## Installation Practices

- Regulators must be sized in accordance with the total appliance load (maximum flow rate), largest single appliance flow rate, inlet pressure range at the regulator inlet, and the desired outlet pressure. (Table 4.5 and Table 4.6)
- Regulators must be installed in accordance with the manufacturer's instructions. Ensure the flow of gas is correct, as indicated by the flow markings on the regulator casing.
- The regulator must be installed in a fully accessible area with an approved shut-off valve upstream. A union can be used to allow for removal of the regulator if the location doesn't allow proper room for regulator servicing.
- Where a gas line pressure regulator is used in a system with a source pressure in excess of 2 PSI to serve appliances rated for 1/2 PSI or less, a regulator with an integrated over-pressure protection device (OPD) must be used. The regulator with OPD must be assembled and listed by the regulator manufacturer in accordance with ANSI Z21.80, *Standard for Line Pressure Regulators*.

Model	7" w.c. (17 mbar)	½ PSI (34 mbar)	¾ PSI (52 mbar)	1 PSI (69 mbar)
325-3	145 (4.0)	204 (5.8)	250 (7.0)	289 (8.2)
325-5A	339 (9.6)	476 (13.5)	583 (16.5)	673 (19.1)

Part No.	Gas Type	Max. Single Appliance Load	Max. Total Load	Outlet Pressure Set Point	Operating Inlet Pressure			
					½ PSI	¾ PSI	1 PSI	1½ PSI
325-3	Natural (0.64 sp. gr.)	140 CFH	250 CFH	8" w.c.	145 (4.1)	200 (5.7)	250 (7.1)	250 (7.1)
				11" w.c.	93 (2.6)	172 (4.9)	225 (6.4)	250 (7.1)
	LP (1.53 sp. gr.)	91 CFH (229 MBTU/hr)	163 CFH (410 MBTU/hr)	11" w.c.	60 (1.7) (152 MBTU/hr)	112 (3.2) (281 MBTU/hr)	146 (4.1) (368 MBTU/hr)	162 (4.6) (409 MBTU/hr)
325-5A	Natural (0.64 sp. gr.)	300 CFH	550 CFH	8" w.c.	335 (9.5)	475 (13.5)	550 (15.6)	550 (15.6)
				11" w.c.	211 (6.0)	391 (11.1)	511 (14.5)	550 (15.6)
	LP (1.53 sp. gr.)	195 CFH (483 MBTU/hr)	358 CFH (901 MBTU/hr)	11" w.c.	286 (8.1) (345 MBTU/hr)	254 (7.2) (639 MBTU/hr)	332 (9.4) (836 MBTU/hr)	357 (10.1) (899 MBTU/hr)

**Note:** The regulator models specified above are provided for reference only. They are not distributed, warranted, or supported by Valencia Pipe Company.

### Vent Limiters and Vent Lines

Regulators must be equipped with a manufacturer-supplied vent limiting device, or be capable of being vented outdoors. When installed indoors, the vent-limiting device is to be used. When a vent-limiter is used, the regulator must be mounted in an upright position for proper function. For outdoor venting, the vent line must be at least the same size as the regulator vent connection and not exceed a length of 30 feet. The vent must be designed to prevent entry of water or other foreign materials that could clog the line. DO NOT vent to an appliance flue, building exhaust system, or pilot light.

If installing the regulator outdoors, remove the vent limiter and mount the regulator with the vent outlet pointing toward the ground to prevent water from entering. If the manufacturer provides a cap for outdoor installations, this can be used and the regulator can be mounted right side up.

**Gas line regulators do not vent gas under normal operating conditions. A regulator that is venting gas should be replaced immediately.**

## Performance Testing

A performance test of the regulator should be conducted to confirm that adequate pressure reaches all appliances. During the test, all appliances should be running at full load to make sure that adequate pressure is maintained under full-load conditions for the gas piping system. The inlet pressure for gas appliances should be equal to, but not greater than, the appliance's recommended inlet pressure range. If the pressure is not within this range, adjustments to the service regulator or the pounds-to-inches gas line regulator may be required to adjust line pressure.

## Regulator Adjustments

Regulators can be adjusted to deliver different outlet pressures downstream of the regulator. To adjust a regulator, remove the seal cap to expose the adjusting screw. Turn the screw clockwise to increase outlet pressure, or counter-clockwise to decrease pressure. (Figure 4.25)

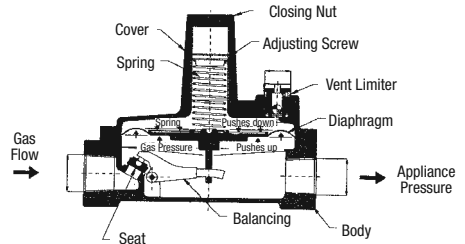

Figure 4.25 Pressure Regulator Diagram

If the spring adjustment doesn't result in the desired pressure, make sure the supply pressure is at least equal to the desired outlet pressure plus the pressure drop of the regulator. If this pressure is adequate, contact to the manufacturer. DO NOT continue to turn the screw clockwise if the outlet pressure reading doesn't increase as this may result in over-firing should there be an increase in inlet pressure.

## 4.9 Underground Installations

Building codes require that gas piping runs that come in contact with earth or other material that could corrode the piping be protected from corrosion. Piping installed beneath (underground) or within the slab of a building must be encased in a nonmetallic water-tight conduit that is vented. Fittings and couplings are not permitted when HOME-FLEX® is installed underground.

**HOME-FLEX® should never be buried directly underground without a conduit.** To route HOME-FLEX® tubing underground, it must be protected within a nonmetallic water-tight conduit that is at least 1/2" larger than the outer diameter of the CSST tubing. Fittings and joints are not permissible in such runs; the run must be one unbroken line of tubing.

For outdoor underground installations, the annular space between the CSST and the nonmetallic conduit must be sealed to prevent entrance of moisture, dirt, debris, and insects.

For indoor buried installations, the annular space between the CSST and the nonmetallic conduit does not have to be sealed. In the event that local code requires the conduit to be vented, the use of a tee designed for use with nonmetallic conduit may be placed at the termination end of the conduit. One end of the tee should be sealed while the other outlet can be used to connect a vent line that is routed outside (See Figure 4.26, Figure 4.27, and "" on page 36). Vent lines routed to the outside of a structure must be installed in such a manner to prevent entrance of moisture, dirt, debris, and insects.

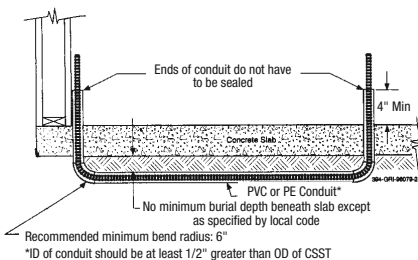

Figure 4.26 Installation in Nonmetallic Conduit Under Slab

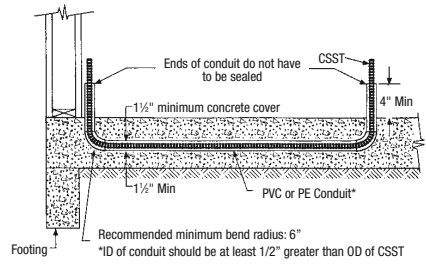

Figure 4.27 Installation in Nonmetallic Conduit In Slab

## Installation Practices

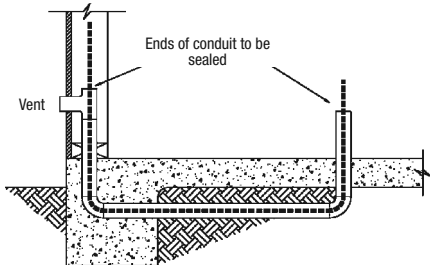

Figure 4.28 Installation in Nonmetallic Conduit with Venting

**Table 4.7 Burial Depths for Underground Routing**

Outdoors	Minimum of 12"
In slab	1-½" minimum concrete coverage
Under slab	No minimum burial depth below slab, or in compliance with local codes

**Table 4.8 Conduit Termination Height for Underground Routing**

Indoors	Conduit to extend a minimum of 1" above finished floor height
Outdoors	Conduit to extend a minimum of 4" above finished grade

Note: If installed underneath mobile homes or in crawl spaces, HOME-FLEX® should be installed in accordance with Section 4.3, *Outdoor Installation Issues*.

## 4.10 Electrical Bonding

Proper bonding and grounding may reduce the risk of damage and fire from electrical arcing to CSST as a result of a lightning strike. Lightning does not have to strike a structure directly to cause damage. Conductive systems, like piping or wiring, can become energized indirectly by a lightning strike. When systems are not properly bonded, the current from the energized line can cause electricity to arc (or jump) from one system to another and damage the CSST. Proper adherence to the bonding instructions should lower the risk of electrical arcing and related damages.

### Bonding Guidelines

In accordance NFPA 54 Section 7.13, Valencia Pipe Company requires proper bonding of HOME-FLEX® gas piping to the electrical grounding system of any structure in which HOME-FLEX® is installed. Electrical work must be performed by a qualified person recognized by the local jurisdictional authority as being capable of performing such work. All installations of CSST for use in natural and propane (LP) gas piping systems in single and multi-family structures, whether or not the connected gas equipment is electrically powered, require direct bonding. Bonding of all systems are to be designed by qualified persons according to the local electrical code.

HOME-FLEX® CSST installations inside or attached to building exteriors are to be electrically continuous and direct bonded to an effective ground-fault current path. Direct bonding of gas piping systems is achieved when the following guidelines are met:

- Direct and permanent connection of a bonding jumper to the electrical service grounding system by connecting to the: electrical service equipment enclosure, the grounding electrode conductor (if of sufficient size), the grounded conductor at the electrical service, or to one or more grounding electrodes. The piping system shall not be used as a grounding electrode for an electrical system.
- A single bond connection near the gas service entrance of the building (or downstream of the gas meter of each housing unit in a multi-family structure) to the structure's gas piping downstream of the utility meter, or the second stage regulator for LP systems. Bonding connections are not to be made to underground natural gas utility service lines or supply lines from LP tanks.



- Bonding/grounding clamp specifications: conductors are to be no smaller than 6 AWG. Bonding clamps are to be listed to UL 467, and be attached in accordance with the *National Electric Code* (NEC) and the listing of the clamp. The attachment point for the bonding conductor is to be accessible. This bond is in addition to any bonding requirements as specified by local codes. Note that the *National Fuel Gas Code* (NFGC) limits the length of the bonding conductor to 75-feet. The bonding connector must be installed and protected in accordance with NEC and NFPA 70.
- Attachment between the CSST gas piping system and the bonding clamp must be made by connecting to a HOME-FLEX® brass fitting (Figure 4.29), or any rigid pipe between the first CSST fitting in the system and the meter (Figure 4.30). Under no circumstance is HOME-FLEX® CSST tubing to be used as the attachment point for the bonding conductor.

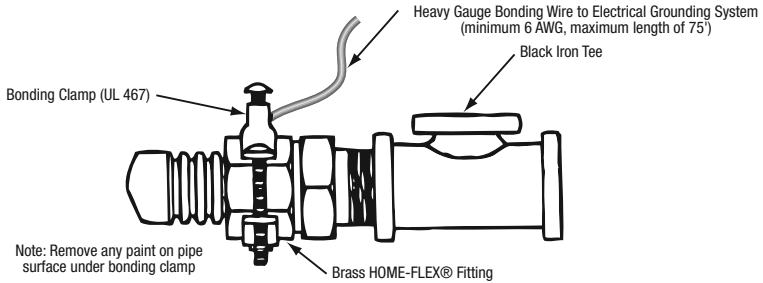

Figure 4.29 Bonding Connection to Brass Fitting

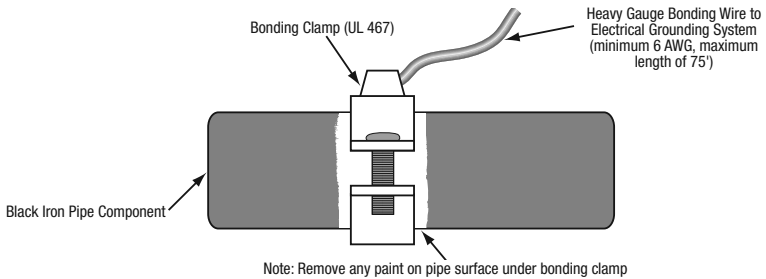

Figure 4.30 Bonding Connection to Rigid Black Iron Pipe

# Chapter 5: Inspection, Repair, and Replacement of CSST

## 5.1 Minimum Inspection Requirements Checklist

All installations shall be inspected by the authority having jurisdiction in accordance with state and local mechanical, electric, and/or plumbing codes, or in the absence of such codes, the *National Fuel Gas Code* (NFPA 54/ANSI Z 223.1), the *International Fuel Gas Code* (IFGC), the *National Electric Code* (NFPA 70), and/or the *Uniform Plumbing Code* (UPC), as applicable.

- Installer has HOME-FLEX® Qualified Installer Card
- Inspection and pressure test completed at rough-in (Chapter 6)
- Only fixed appliances are directly connected to the HOME-FLEX® system (Section 4.6)
- Connections to moveable appliances are made with HOME-FLEX® Flexible Appliance Connectors, or similar approved devices (Section 4.6)
- System properly sized to deliver pressure required for all appliances (Section 3.2 and Chapter 7)
- Regulator, if required, is installed in an accessible location with a shut-off valve mounted ahead of it (Section 4.8)
- If routed underground or through masonry, HOME-FLEX® tubing is properly sleeved (Section 4.3)
- Striker plate protection in place where required (Section 4.4)
- HOME-FLEX® tubing is supported at proper interval (Section 4.1 and Table 4.2)
- No damaged tubing dents or defects (Section 5.2)
- Direct bond to the electrical service grounding electrode system (Section 4.10)

## 5.2 Repair of Damaged Tubing

If tubing is damaged before, during, or after installation, refer to these guidelines to determine the proper course of repair.

### When Pipe Needs to be Replaced

If the tubing is only slightly dented due to impact, it may not need to be replaced. A slight dent is defined as a dent less than  $\frac{1}{3}$  the diameter of the pipe and does not require replacement. (Figure 5.1)

The HOME-FLEX® tubing must be replaced under the following circumstances:

- The tubing has been significantly crushed or dented (a dent greater than  $\frac{1}{3}$  the diameter of the pipe). (Figure 5.2)
- The tubing has been damaged by puncture of ANY kind (nails, screws, drill bits, etc.).
- The tubing has been bent beyond its minimum bend radius such that a crease or kink remains. (Figure 5.3)

### Method Of Repair: Splice or Replace?

HOME-FLEX® can be repaired by splicing through the use of HOME-FLEX® fittings (Figure 5.4), but if the tubing run is short and easily accessible, the preferred repair method is to replace the entire length of tubing. This is often a speedier repair than a splice, and does not add additional fitting joints to the system, avoiding increased pressure loss and simplifying the piping system. The existing HOME-FLEX® fittings can be reused on the new run, so long as they are undamaged. When reusing fittings, the nonmetallic gasket must be replaced to ensure a proper seal.

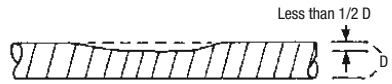

Figure 5.1 Repair Unnecessary

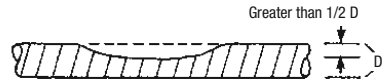

Figure 5.2 Repair Necessary

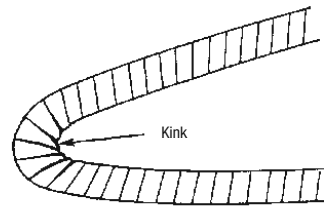

Figure 5.3 Repair Necessary Due to Exceeding Minimum Bend Radius

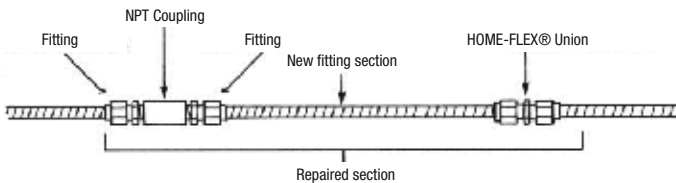

Figure 5.4 Repair of Damaged Tubing with a Spliced New Section

# Chapter 6: Pressure Test Procedures

The final installation must be inspected and tested for leaks in accordance with local and/or state codes. In the absence of local guidelines, test the system at 1½ times the maximum working pressure, but not less than 3 PSI, using the procedures specified in Chapter 8 "Inspection, Testing and Purging" of the *National Fuel Gas Code* (NFPA 54/ANSI Z223). When local codes are more stringent, local codes must be followed. If no local codes apply, test according to the National Fuel Gas Code, IFGC, or UPC. The installer should never pressure test with the pounds-to-inches regulator installed as this may damage the regulator.

## 6.1 Procedure For Low Pressure Systems

- Pressure testing should be performed during rough construction of the facility, before interior walls are finished. This will permit a more complete inspection of the piping system during the pressure testing, and save costly rework in the event of leaks or other problems. **Valencia Pipe Company is not responsible for repairs necessary to correct defects discovered after interior walls are finished.**
- Do not connect appliances or pressurize the system with fuel gas until after the pressure test is completed.
- All gas outlets for appliance connections should be capped during pressure testing.
- **Use only non-corrosive leak check solutions.** Rinse with water and dry the tubing thoroughly after leak detection. Valencia Pipe Company recommends commercially available fluid leak detection solutions.
- Most utilities perform a leak test after setting the gas meter and prior to turning on the gas. This test is performed after the final construction is complete and finished interior walls are in place. This test is performed to assure no damage was done to the tubing during the closing-in construction process.

## 6.2 Procedure For Elevated Pressure Systems

Systems above ½ PSI require a two-part pressure test. The first part is performed on the elevated pressure section, between the meter connection and the pounds-to-inches line gas pressure regulator (Figure 6.1). The second part is performed on the low pressure section, between the pounds-to-inches line gas pressure regulator and the gas appliance outlet. If a steel pipe "jumper" is inserted in place of the line gas pressure regulator the entire system can be pressure tested in one step.

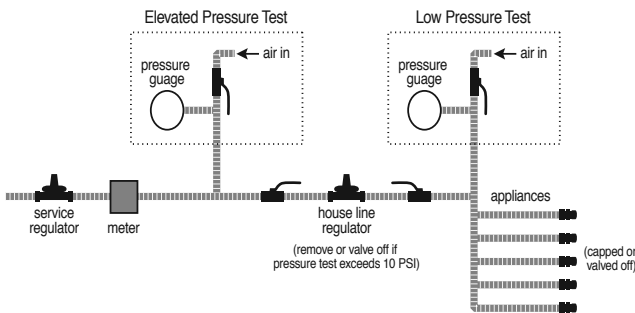

Figure 6.1 Pressure Test Requirements for a 2 PSI System

### 6.3 Appliance Connection Check Procedure

After the final pressure test, inspection, and final construction are complete, appliances may be connected to the HOME-FLEX® gas piping system.

This final connection can be accomplished by a HOME-FLEX® Appliance Connector (or similar device), direct connection with CSST tubing, or with rigid black pipe, depending on the appliance (see Section 4.6 for installation details and guidelines).

Turn the gas on at the meter and inspect for leakage before operating the appliances.

Connections made at the appliances should be leak checked with a commercially available fluid leak detection solution. The tubing system should be purged before placing the appliances in operation to displace the air in the system with fuel gas. Be sure to bleed tubing system into a well ventilated area.

NOTE: Leak test solutions may cause corrosion to some types of material in the gas tubing system. Be sure to water rinse after the test and thoroughly dry all contacted material. Also, the vent limiter should not be leak tested with a liquid test solution. This could contaminate the internal ball check mechanism, or plug the breathing hole, resulting in erratic regulator operation.

# Chapter 7: Sizing/Capacity Tables

## Natural Gas Sizing Tables

Table 7.1 Low Pressure (6 - 7 in w.c. with 0.5 in drop) .....	43
Table 7.2 Low Pressure (6 - 7 in w.c. with 1 in drop) .....	43
Table 7.3 Regulator Outlet (8 - 10 in w.c. with 3 in drop) .....	44
Table 7.4 Medium Pressure (12 - 14 in w.c. with 6 in drop) .....	44
Table 7.5 Elevated Pressure (2 PSI with 1 PSI drop) .....	45
Table 7.6 Elevated Pressure (5 PSI with 3.5 PSI drop) .....	45

## Liquid Petroleum (LP) Sizing Tables

Table 7.7 Propane Low Pressure (11 in w.c. with 0.5 in drop) .....	46
Table 7.8 Propane Medium Pressure (13 - 14 in w.c. with 2.5 in drop) .....	46
Table 7.9 Propane Elevated Pressure (2 PSI with 1 PSI drop) .....	47
Table 7.10 Propane Elevated Pressure (5 PSI with 3.5 PSI drop) .....	47

## Steel Pipe Capacity Charts

Table 7.11 Gas with a Pressure of ½ PSI or less and a pressure drop of 0.5 in w.c. . . .	48
--	----

**Table 7.1 Low Pressure (6 - 7 in w.c. with 0.5 in drop)**

**Maximum Capacity of HOME-FLEX® CSST in Cubic Feet per Hour (CFH) of Natural Gas (Approximate 1000 BTU per cubic foot)**

(Based on a 0.6 specific gravity of gas)

Pressure Drop: **0.5 in w.c.**

Minimum Gas Pressure: **6-7 in w.c. (¼ PSI)**

Tube Size	EHD	Tubing Length (ft)																			
		5	10	15	20	25	30	40	50	60	70	75	80	90	100	125	150	200	300	400	500
½"	18	100	71	59	51	46	42	37	33	30	28	27	26	25	24	21	19	17	14	12	11
¾"	25	283	200	163	141	127	116	100	89	82	76	73	71	67	63	57	52	45	37	32	28
1"	31	626	425	338	288	254	230	195	172	156	143	137	133	124	117	103	93	79	63	54	47

**Table 7.2 Low Pressure (6 - 7 in w.c. with 1 in drop)**

**Maximum Capacity of HOME-FLEX® CSST in Cubic Feet per Hour (CFH) of Natural Gas (Approximate 1000 BTU per cubic foot)**

(Based on a 0.6 specific gravity of gas)

Pressure Drop: **1 in w.c.**

Minimum Gas Pressure: **6-7 in w.c. (¼ PSI)**

Tube Size	EHD	Tubing Length (ft)																			
		5	10	15	20	25	30	40	50	60	70	75	80	90	100	125	150	200	300	400	500
½"	18	132	95	79	69	62	57	50	45	41	38	37	36	34	32	29	27	23	19	17	15
¾"	25	406	287	234	203	182	166	143	128	117	108	105	101	96	91	81	74	64	52	45	41
1"	31	925	627	500	426	376	339	289	255	230	211	203	196	183	173	153	138	117	93	80	70

Equivalent Hydraulic Diameter (EHD): A theoretical sizing which is used to compare the hydraulic performance between manufacturers. A higher EHD number indicates greater flow capacity of piping.

Tables include losses for four 90 degree bends and two (2) end fittings. Tubing runs with larger numbers of bends and/or fitting shall be increased by an equivalent length of tubing according to the following formula:  $L = 1.3 \times (n)$  where  $L$  is the additional length of tubing necessary and  $n$  is the number of additional fittings and/or bends.

Sizing/Capacity Tables

**Table 7.3 Regulator Outlet (8 - 10 in w.c. with 3 in drop)**

**Maximum Capacity of HOME-FLEX® CSST in Cubic Feet per Hour (CFH) of Natural Gas (Approximate 1000 BTU per cubic foot)**

(Based on a 0.6 specific gravity of gas)

Pressure Drop: **3 in w.c.**

Minimum Gas Pressure: **8 - 10 in w.c.**

Tube Size	EHD	Tubing Length (ft)																			
		5	10	15	20	25	30	40	50	60	70	75	80	90	100	125	150	200	300	400	500
½"	18	222	160	132	116	104	96	84	75	69	64	62	60	57	54	49	45	39	32	28	25
¾"	25	692	493	404	351	314	288	250	224	205	190	184	178	168	159	143	131	114	93	81	72
1"	31	1717	1165	928	790	697	630	536	473	427	392	377	363	340	321	283	256	218	173	148	130

**Table 7.4 Medium Pressure (12 - 14 in w.c. with 6 in drop)**

**Maximum Capacity of HOME-FLEX® CSST in Cubic Feet per Hour (CFH) of Natural Gas (Approximate 1000 BTU per cubic foot)**

(Based on a 0.6 specific gravity of gas)

Pressure Drop: **6 in w.c.**

Minimum Gas Pressure: **12 - 14 in w.c. (½ PSI)**

Tube Size	EHD	Tubing Length (ft)																			
		5	10	15	20	25	30	40	50	60	70	75	80	90	100	125	150	200	300	400	500
½"	18	308	222	184	161	145	133	116	104	96	89	86	84	79	75	68	62	54	45	39	35
¾"	25	1058	764	631	552	497	456	398	359	329	306	296	287	272	259	233	214	187	154	135	121
1"	31	2536	1720	1371	1167	1030	930	791	698	631	579	557	537	503	474	418	378	321	256	218	192

Equivalent Hydraulic Diameter (EHD): A theoretical sizing which is used to compare the hydraulic performance between manufacturers. A higher EHD number indicates greater flow capacity of piping.

Tables include losses for four 90 degree bends and two (2) end fittings. Tubing runs with larger numbers of bends and/or fitting shall be increased by an equivalent length of tubing according to the following formula:  $L = 1.3 \times (n)$  where  $L$  is the additional length of tubing necessary and  $n$  is the number of additional fittings and/or bends.



**Table 7.5 Elevated Pressure (2 PSI with 1 PSI drop)**  
**Maximum Capacity of HOME-FLEX® CSST in Cubic Feet per Hour (CFH) of Natural Gas (Approximate 1000 BTU per cubic foot)**  
 (Based on a 0.6 specific gravity of gas)  
 Minimum Gas Pressure: 2 PSI  
 Pressure Drop: 1 PSI

Tube Size	EHD	Tubing Length (ft)																			
		5	10	15	20	25	30	40	50	60	70	75	80	90	100	125	150	200	300	400	500
½"	18	577	408	333	289	258	236	204	183	167	154	149	144	136	129	115	105	91	75	65	58
¾"	25	1982	1421	1170	1019	915	839	730	656	601	558	540	524	495	471	423	387	337	278	242	217
1"	31	5870	4065	3279	2815	2501	2271	1950	1732	1573	1449	1397	1350	1269	1200	1066	968	831	670	575	511

**Table 7.6 Elevated Pressure (5 PSI with 3.5 PSI drop)**  
**Maximum Capacity of HOME-FLEX® CSST in Cubic Feet per Hour (CFH) of Natural Gas (Approximate 1000 BTU per cubic foot)**  
 (Based on a 0.6 specific gravity of gas)  
 Minimum Gas Pressure: 5 PSI  
 Pressure Drop: 3.5 PSI

Tube Size	EHD	Tubing Length (ft)																			
		5	10	15	20	25	30	40	50	60	70	75	80	90	100	125	150	200	300	400	500
½"	18	1131	828	690	606	548	505	444	401	370	345	334	325	308	294	266	245	215	179	157	142
¾"	25	3855	2783	2300	2009	1809	1661	1451	1306	1199	1115	1080	1047	991	943	849	779	681	563	492	443
1"	31	11881	8228	6637	5698	5063	4596	3946	3506	3183	2934	2828	2733	2568	2428	2157	1959	1682	1357	1165	1035

Equivalent Hydraulic Diameter (EHD): A theoretical sizing which is used to compare the hydraulic performance between manufacturers. A higher EHD number indicates greater flow capacity of piping.

Tables include losses for four 90 degree bends and two (2) end fittings. Tubing runs with larger numbers of bends and/or fitting shall be increased by an equivalent length of tubing according to the following formula:  $L = 1.3 \times (n)$  where  $L$  is the additional length of tubing necessary and  $n$  is the number of additional fittings and/or bends.

**Sizing/Capacity Tables**

**Table 7.7 Propane Low Pressure (11 in w.c. with 0.5 in drop)**

**Maximum Capacity of HOME-FLEX® CSST in Cubic Feet per Hour (CFH) of House Propane Gas (Approximate 2520 BTU per cubic foot)**

Minimum Gas Pressure: **11 in w.c.** Pressure Drop: **0.5 in w.c.** (Based on a 1.52 specific gravity of gas)

Tube Size	EHD	Tubing Length (ft)																			
		5	10	15	20	25	30	40	50	60	70	75	80	90	100	125	150	200	300	400	500
½"	18	150	108	90	78	70	65	56	51	47	43	42	41	39	37	33	30	26	22	19	17
¾"	25	447	316	258	223	200	182	158	141	129	119	115	112	105	100	89	82	71	58	50	45
1"	31	990	672	535	455	402	363	309	273	246	226	217	210	196	185	163	147	125	100	85	75

**Table 7.8 Propane Medium Pressure (13 - 14 in w.c. with 2.5 in drop)**

**Maximum Capacity of HOME-FLEX® CSST in Cubic Feet per Hour (CFH) of House Propane Gas (Approximate 2520 BTU per cubic foot)**

Minimum Gas Pressure: **13 - 14 in w.c.** Pressure Drop: **2.5 in w.c.** (Based on a 1.52 specific gravity of gas)

Tube Size	EHD	Tubing Length (ft)																			
		5	10	15	20	25	30	40	50	60	70	75	80	90	100	125	150	200	300	400	500
½"	18	322	232	192	168	151	139	121	109	100	93	90	87	83	79	71	65	57	47	41	37
¾"	25	1000	712	584	507	454	416	361	324	296	274	265	257	243	230	207	189	164	134	117	105
1"	31	2449	1661	1324	1127	994	898	764	675	609	559	537	518	485	458	404	365	310	247	211	186

Equivalent Hydraulic Diameter (EHD): A theoretical sizing which is used to compare the hydraulic performance between manufacturers. A higher EHD number indicates greater flow capacity of piping.

Tables include losses for four 90 degree bends and two (2) end fittings. Tubing runs with larger numbers of bends and/or fitting shall be increased by an equivalent length of tubing according to the following formula:  $L = 1.3 \times (n)$  where  $L$  is the additional length of tubing necessary and  $n$  is the number of additional fittings and/or bends.

**Table 7.9 Propane Elevated Pressure (2 PSI with 1 PSI drop)****Maximum Capacity of HOME-FLEX® CSST in Cubic Feet per Hour (CFH) of House Propane Gas (Approximate 2520 BTU per cubic foot)**Minimum Gas Pressure: **2 PSI**Pressure Drop: **1 PSI**

(Based on a 1.52 specific gravity of gas)

Tube Size	EHD	Tubing Length (ft)																			
		5	10	15	20	25	30	40	50	60	70	75	80	90	100	125	150	200	300	400	500
½"	18	908	637	518	448	399	364	314	280	256	236	228	221	208	197	176	160	138	112	97	87
¾"	25	3259	2353	1945	1699	1530	1404	1226	1104	1014	943	913	885	838	797	718	659	576	476	416	374
1"	31	9279	6426	5183	4450	3954	3590	3082	2738	2486	2291	2209	2135	2005	1896	1685	1530	1313	1059	910	808

**Table 7.10 Propane Elevated Pressure (5 PSI with 3.5 PSI drop)****Maximum Capacity of HOME-FLEX® CSST in Cubic Feet per Hour (CFH) of House Propane Gas (Approximate 2520 BTU per cubic foot)**Minimum Gas Pressure: **5 PSI**Pressure Drop: **3.5 PSI**

(Based on a 1.52 specific gravity of gas)

Tube Size	EHD	Tubing Length (ft)																			
		5	10	15	20	25	30	40	50	60	70	75	80	90	100	125	150	200	300	400	500
½"	18	2108	1491	1217	1054	943	861	745	667	609	563	544	527	497	471	422	385	333	272	236	211
¾"	25	7734	5469	4465	3867	3459	3157	2734	2446	2233	2067	1997	1934	1823	1729	1547	1412	1223	998	865	773
1"	31	20369	13912	11131	9502	8405	7603	6490	5741	5193	4771	4593	4433	4155	3921	3468	3137	2678	2143	1829	1618

Equivalent Hydraulic Diameter (EHD): A theoretical sizing which is used to compare the hydraulic performance between manufacturers. A higher EHD number indicates greater flow capacity of piping.

Tables include losses for four 90 degree bends and two (2) end fittings. Tubing runs with larger numbers of bends and/or fitting shall be increased by an equivalent length of tubing according to the following formula:  $L = 1.3 \times (n)$  where  $L$  is the additional length of tubing necessary and  $n$  is the number of additional fittings and/or bends.

**Table 7.11 Gas with a Pressure of ½ PSI or less and a pressure drop of 0.5 in w.c.**  
**Maximum Capacity of Schedule 40 Metallic Pipe in Cubic Feet per Hour (CFH) of Natural Gas (Approximate 1000 BTU per cubic foot)**  
 (Based on a 0.6 specific gravity of gas)  
 Maximum Gas Pressure: **0.5 PSI**  
 Pressure Drop: **0.5 in w.c.**

Tube Size	Tubing Length (ft)													
	10	20	30	40	50	60	70	80	90	100	125	150	175	200
¼"	43	29	24	20	18	16	15	14	13	12	11	10	9	8
⅜"	95	65	52	45	40	36	33	31	29	27	24	22	20	19
½"	175	120	97	82	73	66	61	57	53	50	44	40	37	35
¾"	360	250	200	170	151	138	125	118	110	103	93	84	77	72
1"	680	465	375	320	285	260	240	220	205	195	175	160	145	135
1¼"	1400	950	770	660	580	530	490	460	430	400	360	325	300	280
1½"	2100	1460	1180	990	900	810	750	690	650	620	550	500	460	430
2"	3950	2750	2200	1900	1680	1520	1400	1300	1220	1150	1020	950	850	800
2½"	6300	4350	3520	3000	2650	2400	2250	2050	1950	1850	1650	1500	1370	1280
3"	11000	7700	6250	5300	4750	4300	3900	3700	3450	3250	2950	2650	2450	2280
4"	23000	15800	12800	10900	9700	8800	8100	7500	7200	6700	6000	5500	5000	4600

# Chapter 8: Technical Information Sheet

## 8.1 HOME-FLEX® Corrugated Stainless Steel Tubing (CSST)

**Tubing Materials:** Type 304 Stainless Steel

**Jacket Materials:** UV/Ozone resistant polyethylene with flame retardant

**Specification Operating Pressure:** 25 PSIG

**Listings:** CSA 256532, IAPMO 7660

**Operating Temperature Range:** -40°F - 200°F

## 8.2 HOME-FLEX® Fittings

**Fitting Materials:** C360 Brass

**Retainer Ring Materials:** C360 Brass

**O-ring Materials:** Silicone

**High Temperature Gasket Materials:** Non-asbestos material

**Specification Operating Pressure:** 25 PSIG

**Listings:** CSA 256532, IAPMO 7660

**Operating Temperature Range:** -40°F - 200°F

## 8.3 HOME-FLEX® Manifolds

**Materials:** Type 304 Stainless Steel

**Specification Operating Pressure:** 25 PSIG

**Listings:** CSA 256532, IAPMO 7660

**Operating Temperature Range:** -40°F - 200°F

## 8.4 HOME-FLEX® Protection Devices

**HOME-FLEX® Striker Plate Materials:** 16-gauge hardened steel

**HOME-FLEX® Bonding Clamp Materials:** Bronze UL 467 Listed

**Listings:** CSA 256532, IAPMO 7660

**Operating Temperature Range:** -40°F - 200°F

## Chapter 9: Definitions

**A.G.A.** American Gas Association

**ANSI Z223.1 1988** The 1988 edition of the National Fuel Gas Code published by American National Standard Institute. Also known as NFPA 54 (National Fire Protection Association).

**Appliance (Equipment)** Any device which utilizes natural gas or propane as a fuel or raw material to produce light, heat, power, refrigeration or air conditioning.

**Approved** Acceptable to the authorities having jurisdiction.

**ASME** American Society of Mechanical Engineers

**ASTM** American Society for Testing and Materials

**Authority Having Jurisdiction** The organization, office or individual responsible for "approving" equipment, an installation or a procedure.

**BTU** Abbreviation for British Thermal Unit, which is the quantity of heat required to raise the temperature of one pound of water one degree Fahrenheit .

**CAN-CGA-B149.1** Natural gas installation book used in Canada.

**CAN-CGA-B149.2** Propane gas installation book used in Canada.

**CFH** Gas flow rate stated in cubic feet per hour.

**CSST** Corrugated stainless steel tubing

**Concealed Gas Piping** Gas piping, which, when in place in a finished building, would require removal of permanent construction to gain access to the piping.

**Connector, Gas Appliance** A factory-fabricated assembly of gas conduit and relating fittings designed to convey gaseous fuel, and used for making connections between a gas supply piping outlet and the gas to an appliance. It is equipped at each end for attachment to standard taper pipe threads.

**Delivery Pressure** Gas pressure available after the gas meter.

**Design Pressure** The maximum operating pressure permitted by this document, as determined by the design procedures applicable to the materials involved.

**Drip Leg** The container (dirt trap pocket) placed at a low point in a system of piping to collect and remove foreign material or condensation.

**EHD (Effective Hydraulic Diameter)** A relative measure of flow capacity used to compare individual sizes between different manufacturers. The higher the EHD number the greater flow capacity of the piping.

**Elevated Pressure System** Refers to any system with a pressure above 1/2 PSIG, but less than 5 PSIG.

**Exposed Gas Piping** Gas piping which will be in view in the finished structure.

**Fuel Gas** A commonly distributed gas used for fuel such as natural gas, manufactured gas, undiluted liquefied petroleum gas (vapor phase only), and liquefied petroleum gas-air mixtures of these gases (including propane and butane).

**Full Lockup** The capability of totally stopping the flow of gas if the load goes to zero, thus preventing the downstream pressure from increasing more than a certain upper limit pressure above the set point.

**Gas Utilization Equipment** Any device which utilizes gas as a fuel or raw material or both.

**ID** Inside diameter of pipe or tubing.

**Inches (" Water Column (w.c.)** Method of stating pressure measured in inches of water column by a manometer or pressure gauge. Commonly used in the gas industry when the pressure is less than one (1) PSI.

$\frac{1}{4}$  PSI = 7 in. w.c.       $\frac{1}{2}$  PSI = 14 in. w.c.      1 PSI = 28 in. w.c.

2 PSI = 56 in. w.c.      5 PSI = 139 in. w.c.

**Joint** A connection between two lengths of tubing or a length of tubing and fitting.

**Listed** Equipment or materials including a list published by an organization acceptable to the authority having jurisdiction and concerned with product evaluation that maintains periodic inspection of production of listed equipment or materials and whose listing states either that the equipment or material meets appropriate standards or has been tested and found suitable for use in a specified manner.

**Load** The amount of gas in CFH required by an appliance, or group of appliances, per their rating plate.

**Lockup Pressure, Regulator** The system pressure, immediately downstream of the regulator, at which the regulator valve will completely close (leak tight) under no-flow conditions to prevent the downstream pressure from exceeding a predetermined level.

**LP Gas** Liquefied petroleum. Fuel gas that is stored and transported in a liquid state, i.e., propane, butane, and mixtures of these and other heavier hydrocarbons.

**MBTU** 1,000 BTUs. See BTU above.

**Manifold (Header)** A pipe or fitting to which a number of branch lines are connected.

**Meter** An instrument installed to measure the volume of gas delivered through a piping system.

**NFPA** National Fire Protection Agency

**OD** Outside Diameter of pipe or tubing.

**Piping** As used in this document, either pipe or tubing, or both. Pipe is a rigid conduit of iron, steel, copper, brass or aluminum, while tubing is a semi-rigid conduit of corrugated stainless steel.

**Piping System** As used in this manual, an assembly of corrugated stainless steel tubing and tubing fittings, intended for field assembly, and installed in residential or commercial building to distribute fuel gas to gas utilization equipment within the building. The piping system may also include a gas pressure regulators, shutoff valves, tube shielding devices, distribution manifolds and other approved devices or components.

**Pressure** Unless otherwise stated, is expressed in pounds per square inch (PSI) above atmospheric pressure (i.e. gauge pressure).

**Pressure Drop** The loss in static pressure of gas due to friction or obstruction in tubing, valves, fittings, regulators and burners.

**PSIG** Pounds per square inch gauge. The pressure, as read from a measurement gage or device. Gauge pressure is pressure above atmospheric pressure and is sometimes referred to as PSI.

**Purge** To displace the original air, or gas, or a mixture of gas and air in a gas conduit with a new air/gas mixture.

**Qualified Installer** A qualified installer must meet applicable qualifications set forth by the state and/or local administrative authorities which enforce the plumbing, mechanical, electrical and/or building codes at the locale where the gas piping is to be installed. The installer must also be certified in the use of the HOME-FLEX® gas piping system.

**Regulator** A device that reduces and controls pressure. It automatically opens and closes in response to changing pressure conditions in the downstream piping.

**Regulator, Gas Appliance Pressure** A device for controlling and maintaining a uniform pressure to the manifold of gas burning equipment. This valve is typically part of the appliance. It reduces the pressure from 5.5" w.c. to the manifold pressure in the appliance.

**Regulator, Line Gas Pressure (PSI to inches w.c.)** A device placed in a gas line between the service regulator and the appliance regulator for controlling, maintaining or reducing the pressure in that portion of the piping system downstream of the device. This valve reduces the house line pressure (typically 2 PSI) to the regulator manifold pressure (typically 8-10" w.c.).

**Regulator, Service Pressure (PSI or inches w.c.)** A device installed by the serving gas supplier to reduce and limit the service line gas pressure. This valve reduces the service pressure to the metering pressure. It is located upstream of the gas meter.

**Regulator Vent** The opening in the atmospheric side of the regulator housing permitting the in and out movement of air to compensate for the movement of the regulator diaphragm.

**Specific Gravity** As applied to gas, the ratio of the weight of a given volume to that of the same volume of air, both measured under the same conditions.

**Striker Plates** A special type of shielding device used when concealed tubing is run through wall studs, floor and ceiling joists or other structural members where tubing movement is restricted.

**Valve, Manual Shut-off** A valve (located in the piping system and readily accessible and operable by the consumer) used to shut off individual equipment.

**Vent Limiter Device** Restriction/orifice type device in the vent outlet of a pressure regulator that controls or limits leakage, in the event of a diaphragm leak. It also allows the diaphragm to move freely to control pressure.



# **HOME-FLEX®**

## **LIMITED WARRANTY**

Valencia Pipe Company, Inc. ("VPC") hereby provides a limited warranty that its HOME-FLEX® Products will be free from any defect of workmanship and material for a period of one year from the date of proof of purchase. If any of the HOME-FLEX® Products are determined to be defective by VPC, the measure of the damage is the price of the defective goods only. No charge for labor or expense required to repair defective goods, or occasioned by them, will be allowed. VPC shall have no liability whatsoever for any amount in excess of the price paid for the HOME-FLEX® Product.

Should any defect of the HOME-FLEX® Product be claimed, the proposed defective HOME-FLEX® Product must be returned to VPC within the limited warranty period of one year from the date of purchase. The obligation of VPC under this limited warranty is, VPC at its discretion, may replace the defective HOME-FLEX® Product, repair the defective HOME-FLEX® Product or refund the purchase price paid for the HOME-FLEX® Product following receipt by VPC of proof of purchase of its HOME-FLEX® Product.

This limited warranty shall not apply to any part or parts of the HOME-FLEX® Products if it has been installed, altered, repaired or misused, through negligence or otherwise, in a way that in the opinion of VPC affects the reliability of, or detracts from, the performance of the product. Nor does this limited warranty cover replacements or repairs necessitated by loss or damage resulting from any cause beyond the control of VPC, including but not limited to acts of God, acts of government, floods or fires.

In order for the VPC limited warrant to apply; the HOME-FLEX® Product installation must have been performed strictly in accordance with local plumbing and/or building codes, and in accordance with the HOME-FLEX® CSST Flexible Gas Pipe System Design and Installation Manual. The VPC limited warranty will only apply if the HOME-FLEX® product was installed by a Qualified Installer who has been certified in a manner recognized by VPC and has been issued an HOME-FLEX® Qualified Installer Card from VPC.

The foregoing is in lieu of any other warranties, expressed, implied or statutory and VPC neither assumes nor authorizes any person to assume for VPC any other obligation or liability in connection with the sales of its products. The VPC limited warranty implies no warranty of merchantability or fitness for a particular purpose and is hereby disclaimed and excluded from the VPC limited warranty. VPC also reserves the right to repair or replace that part of the HOME-FLEX® Product that is determined by VPC to have been determined to have a defect during the limited warranty period.



## Registering for your Qualified Installer Card is Easy:

Scan the QR code below, or point your web browser to *register.homeflex.com* and submit the web form. Then either write your Installer Number on the card below, or print the Qualified Installer Card from the confirmation page.



### HOME-FLEX® QUALIFIED INSTALLER CARD

Date:      /      /           Nº: \_\_\_\_\_  
          MM      DD      YY



I, \_\_\_\_\_  
Please PRINT Your Name Here

have read the HOME-FLEX® *System Design and Installation Manual* and understand the installation requirements of the HOME-FLEX® CSST system. I am a Qualified Installer of gas plumbing per the governing local authority at the location where HOME-FLEX® is to be installed, and am aware of all local plumbing and/or building codes applicable to this location.



For technical support, call:

**661-257-3923**

or email:

**info@homeflex.com**

HOME-FLEX® Qualified Installer  
registration can be completed online:

**homeflex.com**



**HOME-FLEX®**

**Qualified Installer Card**