

Atomic Digital Office Clock

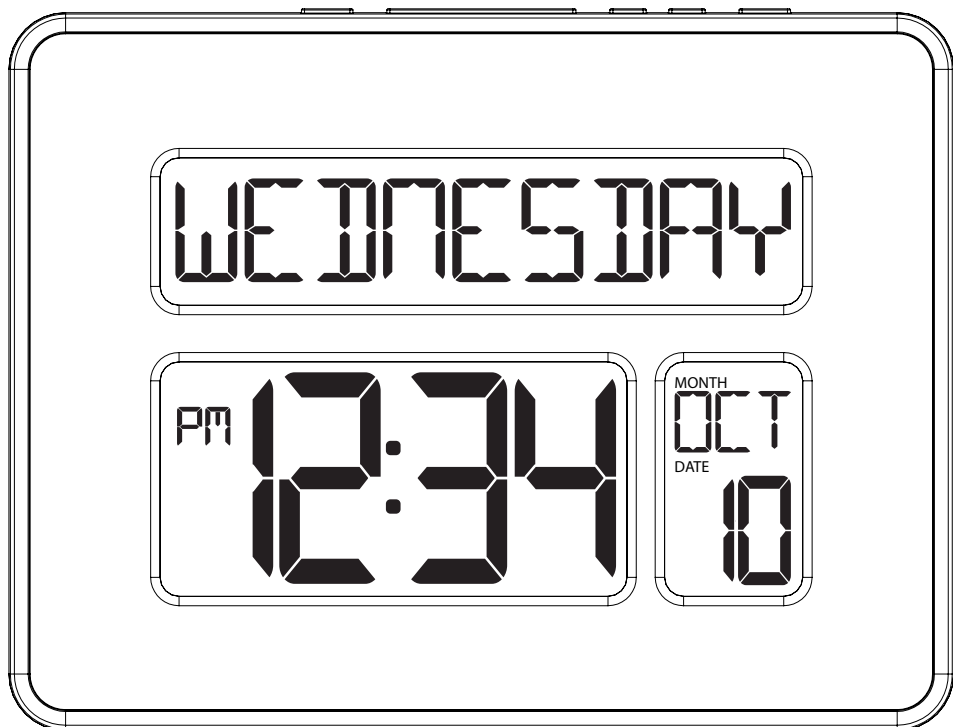
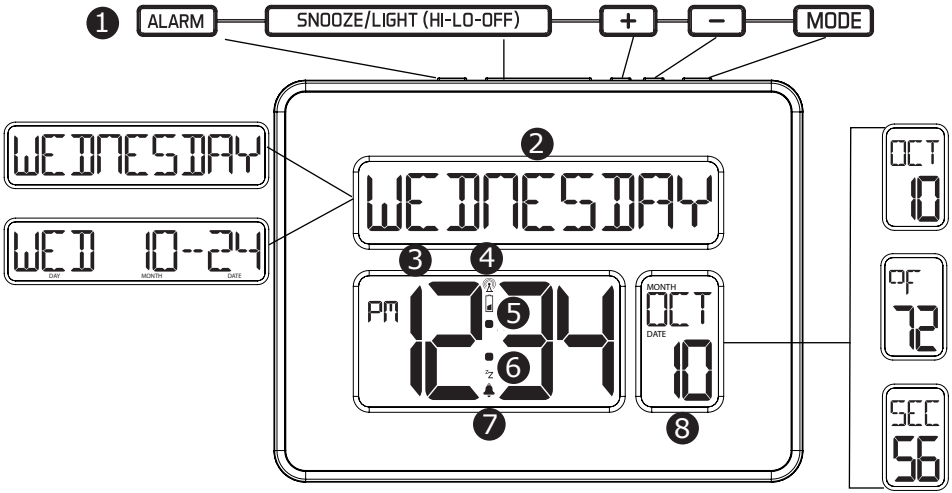

Table of Contents

LCD Features	1
Custom Display Modes	1
Setup	2
Atomic Time Signal	2
Settings: Language, Time, Date, etc.	2
Set Alarm Time	5
Activate/Deactivate Alarm	5
Snooze	5
Care and Maintenance	6
Warranty and Support	6
Specifications	6
Low Battery Icon	6
FCC Statement	7
Canada Statement	7

LCD Features



- ① Buttons (on top)
- ② Displays Weekday or Weekday/Month/Date
- ③ Atomic Time
- ④ Atomic Time Reception Icon
- ⑤ Low Battery Icon
- ⑥ Snooze Icon **Zz**
- ⑦ Alarm Active Icon (bell)
- ⑧ Displays Date, Seconds or Indoor Temperature

Custom Display Modes

- Press and release the MODE button to customize how the top and right sections of the clock are displayed.
- The clock will stay in the mode selected.

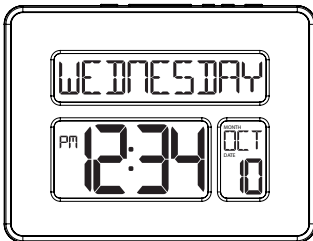

MODE 1:
Weekday &
Month/Date

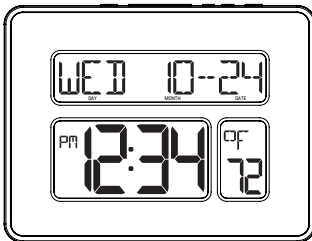

MODE 2:
Day/Month/Date
& Temperature

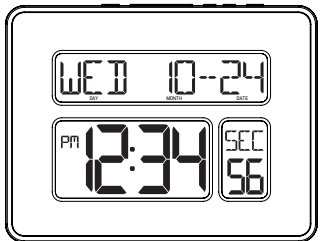

MODE 3:
Day/Month/Date
& Seconds

Setup

1. Insert the 5.0 volt AC adapter into the outlet then into the clock.
2. (Optional) Insert 2 "AA" batteries into the clock according to polarity markings.
3. Set Time/Date

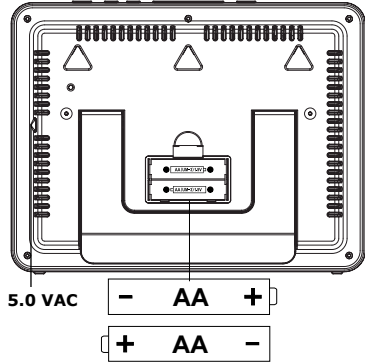

Note: The clock will search for atomic time 2 hours after batteries are installed. The backlight will be out briefly during the search.

Atomic Time Signal

- The clock will automatically search at UTC 7:00, 8:00, 9:00, 10:00, and 11:00.
- If there is no WWVB reception, the clock will search for the atomic time signal every 2 hours until the WWVB time is received.
- From normal time display hold the MINUS button for 3 seconds, to search for the WWVB time signal.
- Press the MODE button to select daylight saving time OFF.
- For information about WWVB visit: <http://bit.ly/AtomicTime>

Note: If your clock advances one hour in December it is due to a leap second adjustment that was programmed incorrectly. If this happens your clock will automatically correct itself Jan 1st.

There are two easy ways to immediately correct the hour.

1. Use the setting menu to select DST OFF then set the hour back one hour – or the clock will correct the hour overnight with the next WWVB reception. Then in January use the setting menu to turn DST ON and resume normal use.
2. Use the setting menu to turn WWVB OFF and set the correct hour

Either way your clock will resume normal WWVB functions Jan 1st with the DST ON setting.

We apologize for the inconvenience caused by our programming error

Settings: Language, Time, Date, etc.

- Hold the MODE button to enter time set mode.
- Press the + or - buttons to adjust the values.
- Press the MODE button to confirm adjustments and move to the next item.
- Press the SNOOZE button at any time to exit.

Time set order:

- 1. Language (English or Spanish)
- 2. Beep ON/OFF
- 3. Atomic ON/OFF
- 4. Time Zone
- 5. DST ON/OFF
- 6. 12/24 Hour
- 7. Hour
- 8. Minutes
- 9. Year
- 10. Month
- 11. Date
- 12. Fahrenheit/Celsius

1. Hold the MODE button for 3 seconds to enter settings mode. ENGLISH will show. Use the +/- button if you wish to select ESPAÑOL (Spanish).

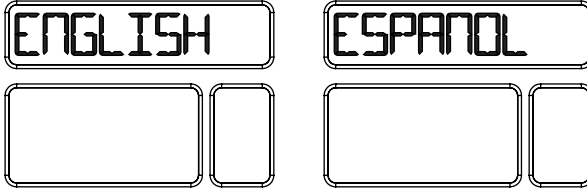

2. Press the MODE button to move to BEEP ON/OFF. Use the +/- button to turn off the beep sound.

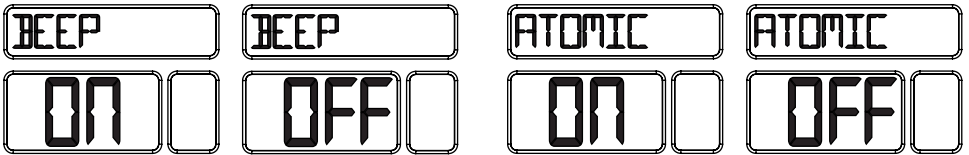

3. Press the MODE button to select atomic time signal ON/OFF. Use the +/- button if you do not want atomic time reception.

Note: If you choose OFF for atomic time, the clock will skip time zone and DST setting and jump to 12/24 hour time.

4. Press the MODE button to select your time zone. Use the +/- button to adjust.

AST = Atlantic
EST = Eastern
CST = Central
MST = Mountain
PST = Pacific
AKT = Alaska
HAT = Hawaii

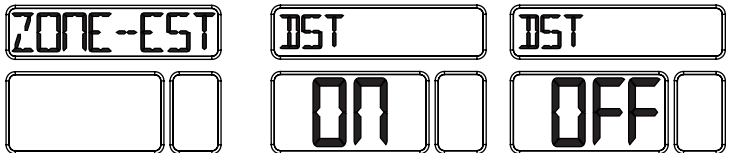

All States except Arizona must set the DST mode to OFF.

5. Press the MODE button to select daylight saving time OFF. If you do not observe DST, use the +/- button to turn off the Daylight Saving Time Indicator.

6. Press the MODE button to select 12 hour or 24 hour time format.
Use the +/- button to adjust.

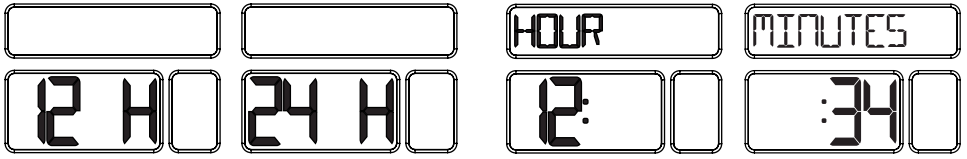

7. Press the MODE button to set the Hour.
Press the +/- button to adjust.
8. Press the MODE button to set the Minutes.
Press the +/- button to adjust. Hold to adjust quickly.

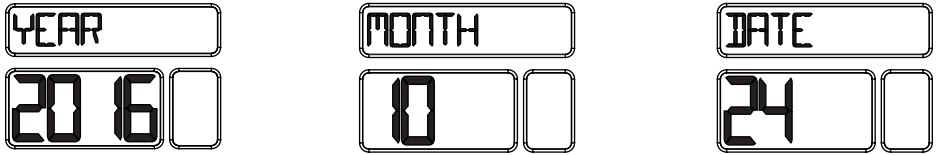

9. Press the MODE button to set the Year.
Press the +/- button to adjust.
10. Press the MODE button to set then set the Month.
Press the +/- button to adjust. Hold to adjust quickly.
11. Press the MODE button to set the Date.
Press the +/- button to adjust. Hold to adjust quickly.
12. Press the MODE button to select Fahrenheit or Celsius temperature display. Press the +/- button to adjust.

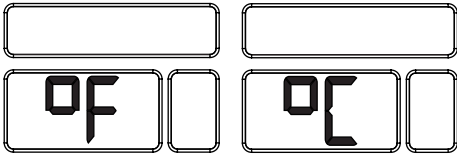

13. Press the MODE button to confirm and exit.

Note: Press the SNOOZE button at any time to exit settings.

Backlight: HI-LOW-OFF

- When operating with the AC adapter, the backlight is adjustable: (HI-LOW-OFF).
- Press and release the SNOOZE/LIGHT HI-LOW-OFF button to adjust backlight.
- When operating on batteries only, the backlight will come on briefly when the SNOOZE button is pressed.

Set Time Alarm

1. Hold the ALARM button to enter alarm settings. "AL" will show.
2. The Alarm Hour will flash. Press the +/- button to adjust.

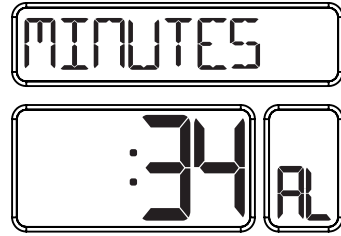
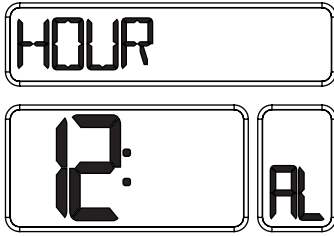

3. Press the ALARM button to set the Minutes.
4. The Alarm Minutes will flash. Press the +/- button to adjust. Hold to adjust quickly.
5. Press the ALARM button to confirm and exit.

Activate/Deactivate Alarm

1. Hold the ALARM button to enter alarm settings. "AL" will show.
2. Press and release ALARM to activate/deactivate the alarm.
3. The bell icon will show when active.

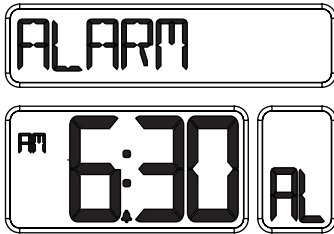

Alarm ON

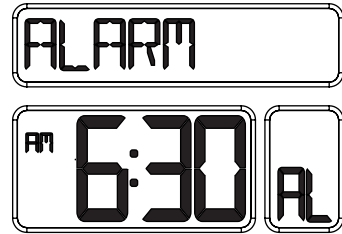

Alarm OFF

Snooze

1. When alarm sounds press the SNOOZE button to silence the alarm for 10 minutes.
2. The alarm bell icon will show and **Zz** will flash.
3. Press any button except SNOOZE to stop the alarm for 1 day.

Note: Alarm is crescendo sound. When the alarm sounds, it continues for 2 minutes and then shuts off completely.

Care and Maintenance

- Do not mix old and new batteries.
- Do not mix Alkaline, Standard, Lithium or Rechargeable Batteries
- Always purchase the correct size and grade of battery suitable for intended use.
- Replace all batteries of a set at the same time.
- Clean the battery contacts and also those of the device prior to battery installation.
- Ensure the batteries are installed with correct polarity (+ and -).
- Remove batteries from equipment which is not to be used for an extended period
- Promptly remove expired batteries.

Warranty and Support

La Crosse Technology, Ltd. provides a 1-year limited time warranty (from date of purchase) on this product relating to manufacturing defects in materials & workmanship.

Before returning a product, please contact our friendly customer support with questions or visit our online help:

Phone: 1-608-782-1610

Online Product Support:

www.lacrossetechnology.com/support

Product Registration:

www.lacrossetechnology.com/support/register

View full warranty details online at:

www.lacrossetechnology.com/warranty_info.pdf

Warranty Address:

La Crosse Technology, Ltd
2830 S. 26th St.
La Crosse, WI 54601

Protected under U.S. Patents:
5,978,738 | 6,076,044 | RE43903



Specifications

Temperature Range: +32 °F to +99°F (0°C to 37°C)

Power: 5.0VAC # GPU280500150WA00

Optional-2-AA, IEC, LR6 batteries (included)

Battery Life: Battery life is over 24 months when using reputable brands

Dimensions: 9.84" W x 7.48" H x 1.14" D (250 x 190 x 29 mm)

Low Battery Icon

- The low battery icon will appear between the hour and minutes.
- This icon indicates it is time to replace the batteries.

FCC Statement

This equipment has been tested and found to comply with the limits for a Class B digital device, pursuant to part 15 of the FCC Rules. These limits are designed to provide reasonable protection against harmful interference in a residential installation. This equipment generates, uses and can radiate radio frequency energy and, if not installed and used in accordance with the instructions, may cause harmful interference to radio communications. However, there is no guarantee that interference will not occur in a particular installation.

If this equipment does cause harmful interference to radio or television reception, which can be determined by turning the equipment off and on, the user is encouraged to try to correct the interference by one or more of the following measures:

- Reorient or relocate the receiving antenna.
- Increase the separation between the equipment and receiver.
- Connect the equipment into an outlet on a circuit different from that to which the receiver is connected.
- Consult the dealer or an experienced radio/TV technician for help.

This device must not be co-located or operating in conjunction with any other antenna or transmitter.

Operation is subject to the following two conditions:

- (1) This device may not cause harmful interference, and
- (2) This device must accept any interference received, including interference that may cause undesired operation.

Caution!

The manufacturer is not responsible for any radio or TV interference caused by unauthorized changes or modifications to this equipment. Such changes or modifications could void the user authority to operate the equipment.

All rights reserved. This manual may not be reproduced in any form, even in part, or duplicated or processed using electronic, mechanical or chemical process without the written permission of the publisher.

This booklet may contain errors or misprints. The information it contains is regularly checked and corrections are included in subsequent editions. We disclaim any responsibility for any technical error or printing error, or their consequences.

All trademarks and patents are recognized.

Canada Statement

This device complies with Industry Canada's license-exempt RSSs.

Operation is subject to the following two conditions:

- (1) This device may not cause interference; and
- (2) This device must accept any interference, including interference that may cause undesired operation of the device.