

## CARE AND MAINTENANCE

To clean the outside of the fixture, use a dry or slightly dampened clean cloth (use clean water, never a solvent) to wipe the surface of the fixture.

To clean the inside of the fixture, first disconnect power to the fixture by turning off the circuit breaker or by removing the fuse at the fuse box. Next, use a dry or slightly dampened clean cloth (use clean water, never a solvent) to wipe the interior surface of the fixture.

Do not use any cleaners with chemical, solvents or harsh abrasives. Use only a dry soft cloth to dust or wipe carefully.

## NOTICE & IMPORTANT SAFETY INSTRUCTIONS

\* Please make sure that you have all parts indicated before you begin assembly of this item

\* This item should be assembled on a soft surface to prevent scratching the finish during assembly

\* To reduce the risk of fire, electrical shock or injury to persons or property, please follow the guideline below for safe use and installation

\*The external flexible cable or cord of this luminaire cannot be replaced











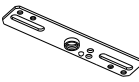

If the cord is damaged, the luminaire shall be destroyed



Model#: LIT4192A

Product Dimensions: 16"D X 11.25"H

## Part List and Hardware List

| PIECE | DESCRIPTION      | PICTURE   | QUANTITY | PIECE | DESCRIPTION     | PICTURE   | QUANTITY |
|-------|------------------|---|----------|-------|-----------------|---|----------|
| A     | mounting screw   |    | 2X       | H     | hex nut         |    | 1X       |
| B     | mounting bracket |   | 1X       | I     | threaded rod    |   | 1X       |
| C     | machine screw    |  | 2X       | J     | glass diffuser  |  | 1X       |
| D     | wire connector   |  | 3X       | K     | decorative disc |  | 1X       |
| E     | screwed ball     |  | 2X       | L     | finial          |  | 1X       |
| F     | ground screw     |  | 1X       | M     | bulb            |  | 3X       |
| G     | canopy           |  | 1X       |       |                 |   |          |

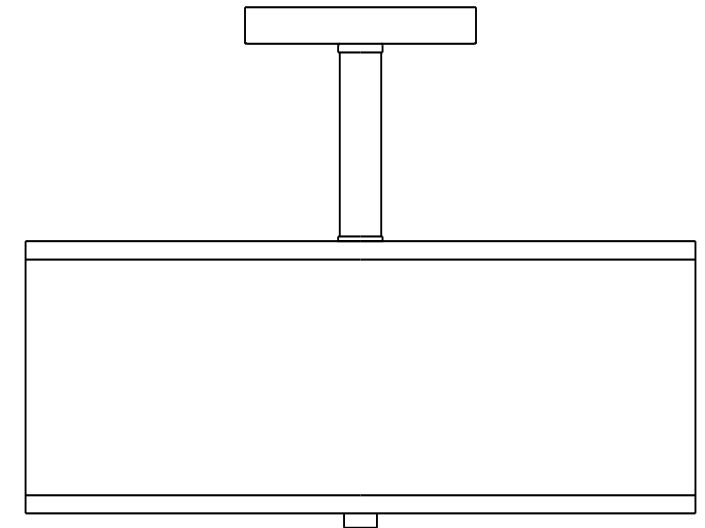

## PREPARATION

Before beginning assembly of product, make sure all parts are present. Compare parts with package contents list and hardware contents list. If any part is missing or damaged, do not attempt to assemble the product.

Estimated Assembly Time: 20 minutes.

1. Fix the mounting bracket (B) to the outlet box with machine screw (C).
2. Make wire connections, with wire connectors (D), following the reference chart listed below.

| Connect, Hot, Black or Red Outlet Supply Wire to:            | Connect, Neutral, White Outlet Supply Wire to:            |
|--|---|
| Black  | White   |
| * Parallel Cord (round & smooth)                             | * Parallel Cord (square & ridged)                         |
| Clear, Brown, Gold or Black without Tracer (colored stripes) | Clear, Brown, Gold or Black with Tracer (colored stripes) |
| Insulated Wire (not green) with copper metal conductor       | Insulated Wire (not green) with Silver metal conductor.   |

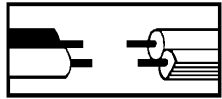

\*Note: When parallel wire (SPT I & SPT II) is used. The neutral wire is square shaped and ridged and the hot wire will be round in shape and smooth. (See Illustration on left.)

### Grounding Instructions:

- a) For installation in the United States: Wrap ground wire from outlet box around green ground screw (F) on mounting bracket, no less than 2" from wire end. Tighten ground screw. If fixture is supplied with a ground wire, connect to outlet ground wire with a wire connector.
  - b) For installation in Canada: If fixture is supplied with ground wire, wrap ground wire around green grounding screw on mounting bracket. Tighten ground screw.
3. Orient the ceiling canopy (G) so that the mounting screws (A) protruding from the mounting bracket go into the holes in the canopy, then secure it with the provided screwed balls (E).
  4. Install bulbs (M). Be sure to use light bulb (M) with wattage no greater than specified on this fixture. Always make sure that electrical current is turned off before changing bulbs.
  5. Fix the threaded rod protruding from canopy into the hex nut (H) on top of the shade, and then put on glass diffuser (J) onto the bottom of the shade, secure it with decorative disc (K) and finial (L).

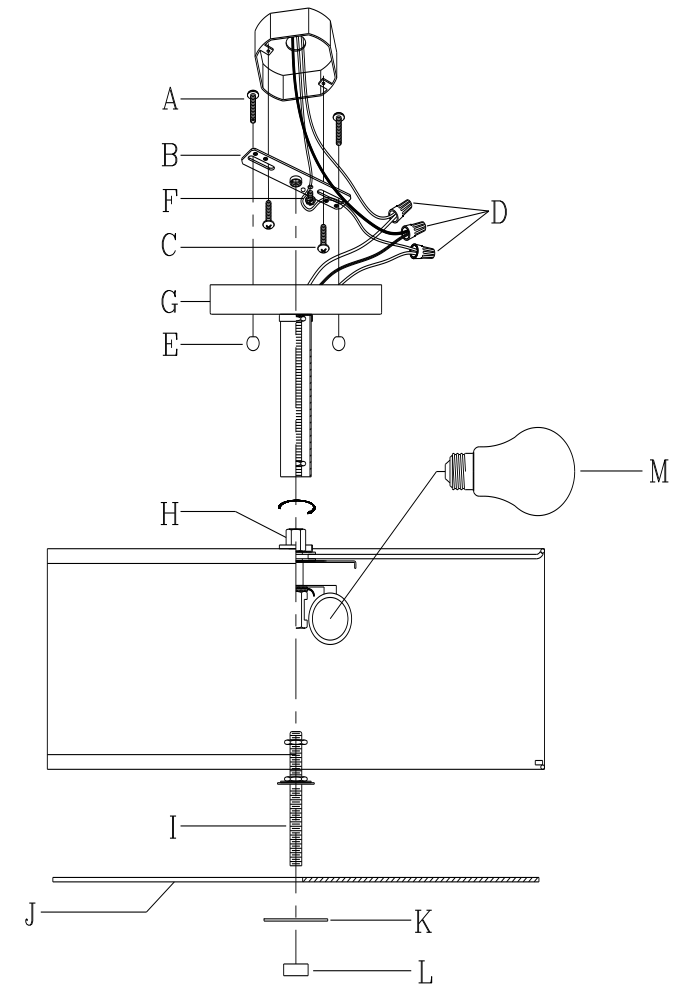

ENJOY YOUR LAMP