

INSTALLATION INSTRUCTIONS

Item#4594-575 (New. 11/14/2017)

READ AND SAVE THESE INSTRUCTIONS

WARNING! SHUT POWER OFF AT FUSE OR CIRCUIT BREAKER.

AVERTISSEMENT! COUPER LE COURANT AU NIVEAU DES FUSIBLES OU DU DISJONCTEUR.

MOUNTING THE FIXTURE (Fig.1)

1. Shut off the power at the circuit breaker and remove the old fixture, including the mounting hardware.
2. Carefully remove the fixture from the carton and check that all parts are included as shown in the illustration.
3. Position mounting plate (B) on the wall, and mark the location of two dry wall anchors (A). Pre-drill the holes for the dry wall anchors. Insert the dry wall anchors (A) into the wall.
4. Attach the mounting plate (B) to the junction box using the Mounting screws (C). The side of the mounting plate marked "GND" must face out.
5. Place the wood screw (D) through the keyhole into the dry wall anchor (A) to secure the Mounting plate (B) as shown in Fig.1.

CONNECTING THE WIRES (Fig. 2)

6. At this point, connect the electrical wires as shown in Fig. 2, making sure that all wire connectors are secured. If your outlet box has a ground wire (green or bare copper), connect the fixture's ground wire to it. Otherwise, connect the fixture's ground wire directly to the mounting plate using the green screw provided. After the wires are connected, tuck them carefully inside the junction box.

FINISHING THE INSTALLATION (Fig.1)

7. Place fixture body (E) over mounting plate (B) and fasten with Screws (F).
8. Place the candle cover (I) over the socket.
9. Install light bulb(s) (H) in accordance with the fixture's specification. **(DO NOT EXCEED THE MAXIMUM WATTAGE RATING!) (NE PAS DEPASSER LA PUISSANCE NOMINALE MAXIMALE!).**
10. Place the glass shade (G) twist to the holder (J). (In clockwise direction)

Your installation is now complete. Return power and test the fixture.

Note: Illustration (Fig.1) on this manual is for installation purposes only. It may or may not be identical to the fixture purchased.

Fig. 1

Set#A-021-620108
-Mounting Plate
-Ground Screw
-Mounting Screw*2

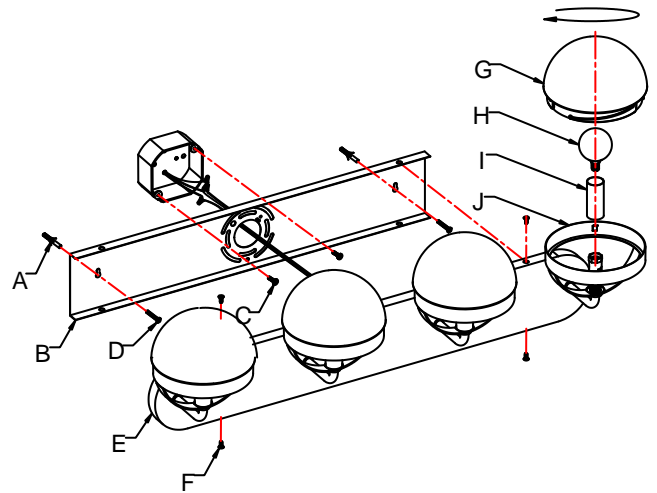

Candle Cover#CCV24060P-575

Fig. 2

