

Trade Mark:
CRYSTAL WORLD INC

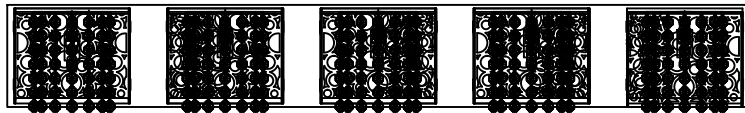

Product Name: Wall lamp
Model :5536W43ST-R-5
120Vac, 60Hz,AC ONLY
Lamp Size:W43"*H6"*E4"



WALL LAMP ASSEMBLY INSTRUCTIONS

1. Place fixture(A) onto Butterfly (EE).
Secure(DD) with cap nuts (AA).

Hardware Used

AA Cap nut		X 5
DD Mounting screw		X 5

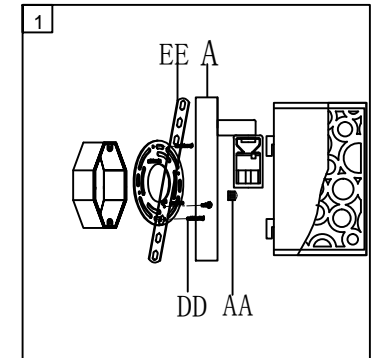

2. Please wear gloves
when you hanging the crystal.

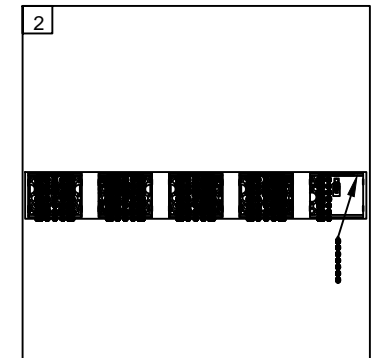
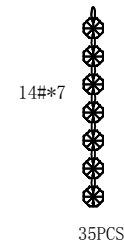

3. Install light bulbs (not included).
Use bulb
120V G9  5*40W Max.

