

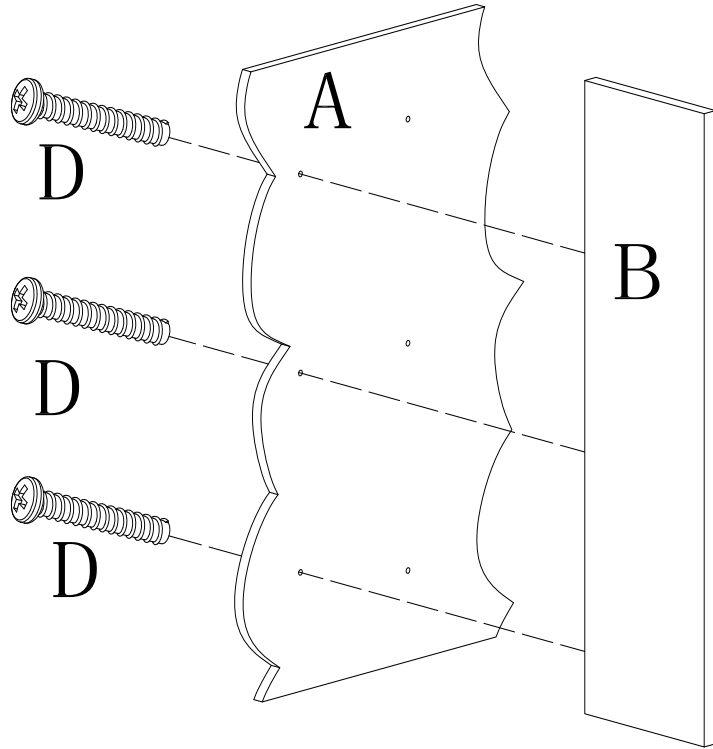

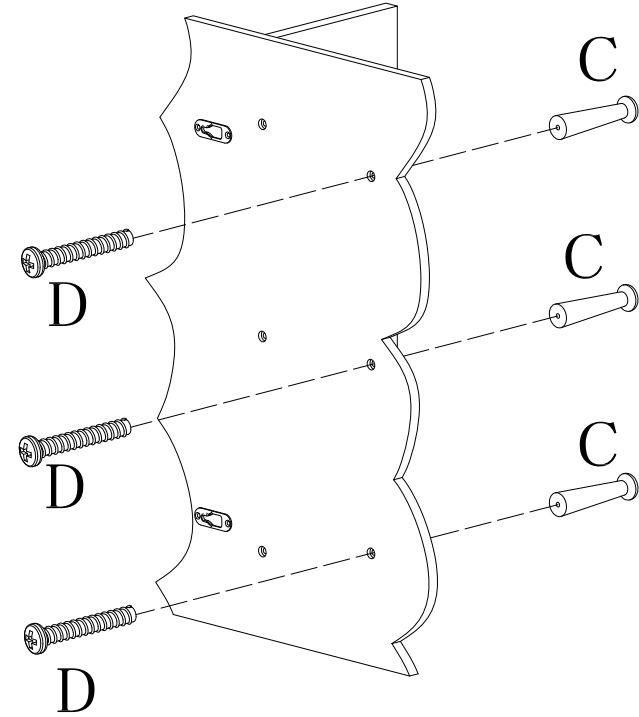

Step 1



Step 2

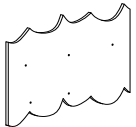

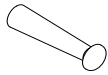
30508 New Fish Shelf

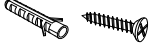
A	B	C	D	E
			 Ø4×22mm	 WALL MOUNTING SET
1PC	1PC	3PCS	6PCS	2SETS

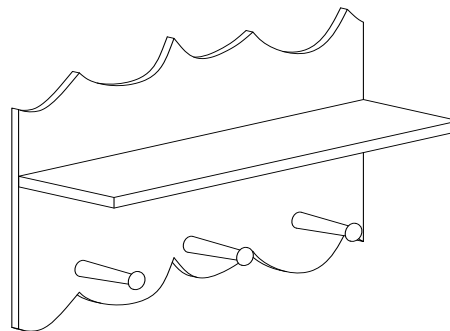

This product contains composite wood that complies with Phase 2 of CA ATCM 93120 for formaldehyde.

Cet article contient du bois composite conforme à la Phase 2 de CA ATCM 93120 relative au formaldéhyde.

Este producto contiene madera compuesta que cumple con la Fase 2 de CA ATCM 93120 para el formaldehído.

WARNING:
 DO NOT MOUNT ABOVE A CRIB OR WITHIN REACH OF AN INFANT OR CHILD.

AVERTISSEMENT:
 NE PAS MONTER AU-DESSUS D'UN BERCEAU NI À PORTÉE D'UN NOURRISSON OU D'UN ENFANT.

ADVERTENCIA:
 NO MONTAR ARRIBA DE UNA CUNA AL ALCANCE DE UN INFANTE O NIÑO.