

ITEM NO.	P/N	Description	QTY.
1	FRBP	BACKPLATE	2
2	FR-PST	POST	4
3	TU1-8	TUBE	2
4	CARD-1	CAP	4
5	RGTWT	HUB	4

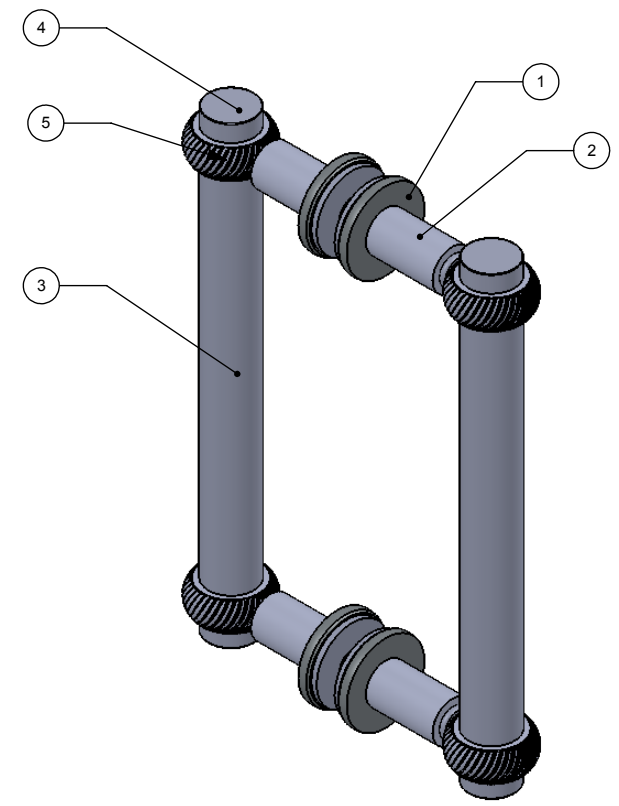
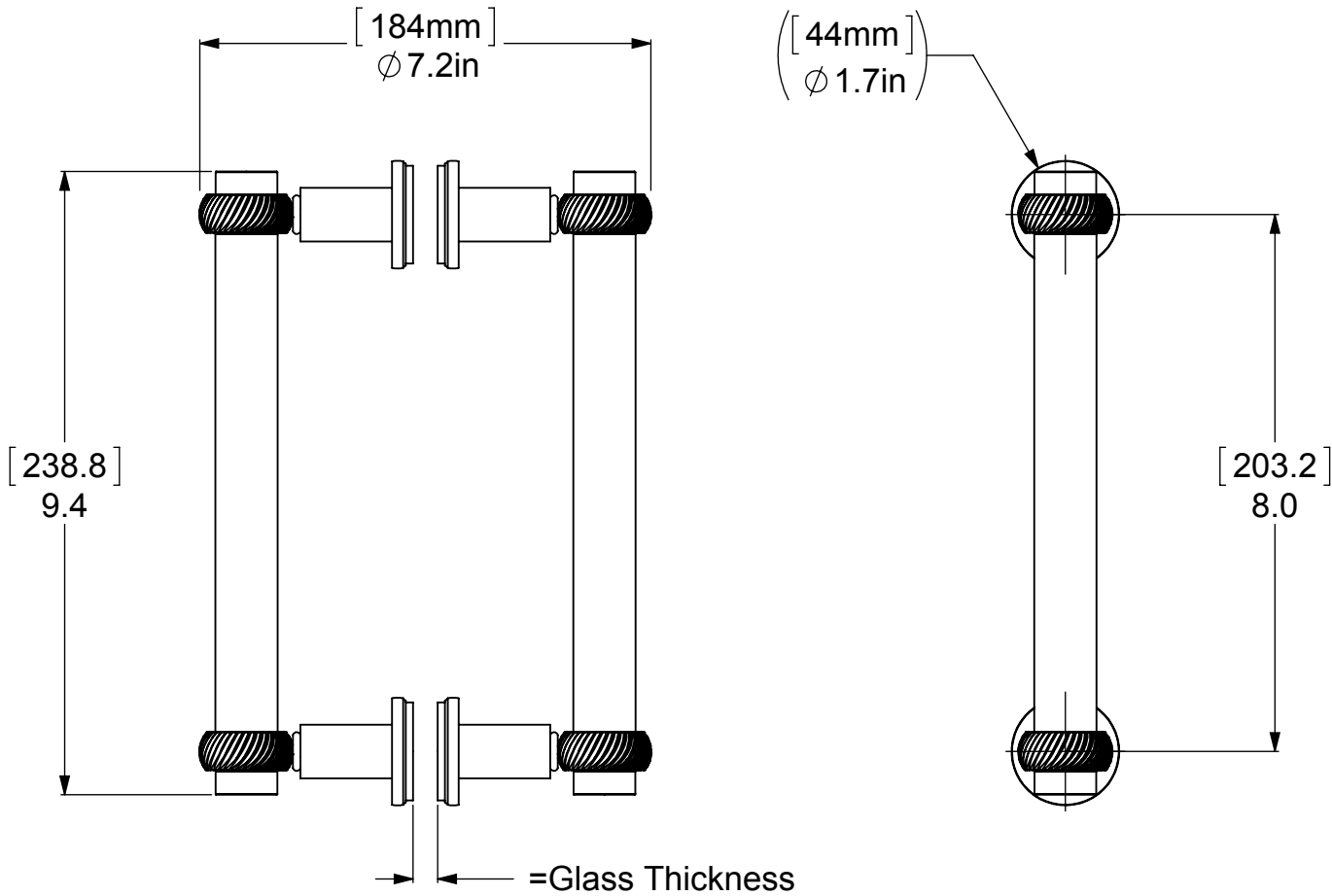

UNLESS OTHERWISE STATED

.X	±.3mm
.XX	±.15mm
.XXX	±.008mm

COPYRIGHT © Allied Brass 2016

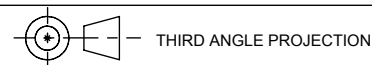

DRAWN	8/13/2016	I.M
CHECKED	8/13/2016	P.D
APPROVED	8/13/2016	R.A

MATERIAL:	BRASS
DESCRIPTION:	SHOWER DOOR PULL

FINISH	TBD
QUANTITY	TBD
DRAWING No.	404T-8BB
REV	0
SCALE	1:3
SHEET: 01	A4