

**DOREL ASIA**

---

**5-PC PEDESTAL  
DINING SET**

**Model No:**  
DA7104B

**UPC CODE:**  
0-65857-16532-6



**NOTE:**

THIS INSTRUCTION BOOKLET  
CONTAINS **IMPORTANT** SAFETY  
INFORMATION. PLEASE READ AND  
KEEP FOR FUTURE REFERENCE.

Lot number:  
(TAKEN FROM CARTON)

---

Date of purchase:

\_\_\_\_\_ / \_\_\_\_\_ / \_\_\_\_\_.

**DO NOT RETURN PRODUCT TO THE STORE.**

If a part is missing or damaged, contact our customer service  
department. We will replace the part **FREE** of charge.

Tel #: 1-800-295-1980  
E-Mail: das@dorel.com



## CUSTOMER SERVICE

If you are missing parts or have any questions about this product, contact our customer service representative first!

 **CALL 1-800-295-1980**

You can also order parts by writing to the address listed below. Please include the product model number, color and a detailed description of the part.

**Customer Service Department No. 413**

**12345 Albert-Hudon Boulevard, Suite 100**

**Montreal, Quebec**

**Canada H1G 3L1**

**E-MAIL: [das@dorel.com](mailto:das@dorel.com)**

## NOTES:

- \* Ensure all parts and components are present before beginning assembly.
- \* Assemble on a soft, smooth surface to prevent damage to product finish.
- \* Phillips head screw driver is not included.
- \* **DO NOT** use power tools.
- \* **CAUTION:** Adult assembly required.
- \* Assembly will require two people.
- \* Estimated assembly time: 45 minutes.

## CARE AND CLEANING

Dust table regularly with a soft, dry cloth to prevent soil build up. A dampened cloth may be used occasionally to clean the surface. Dry immediately and buff lightly, following the grain. Avoid using harsh cleaners and abrasive products.

Use coasters to prevent the formation of moisture rings and trivets to protect from hot items. Cover extension leaves (if applicable) with a soft protective fabric before storing. Do not slide objects across the surface - always lift them.

## MAINTENANCE

Check bolts/screws periodically and tighten them if necessary.

## LIMITED WARRANTY

Dorel Asia warrants its product to be free from defects in material and workmanship and agrees to remedy any such defect. This warranty covers 1 year from the date of original purchase. This warranty is valid only upon presentation of proof of purchase. This is solely limited to the repair or replacement of defective furniture components and no assembly labor is included. This warranty does not apply to any product which has been improperly assembled, subjected to misuse or abuse or which has been altered or repaired in any way. This warranty gives you specific legal rights and you may also have other rights which vary from State to State.







**WARNING: Should this product become damaged, and/or components are broken or missing, DO NOT USE.**

# DA7104B

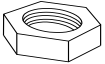
## 5-PC PEDESTAL DINING SET

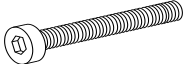
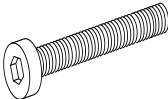
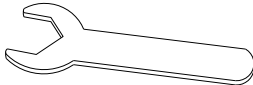

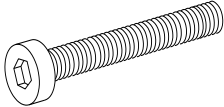
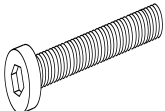
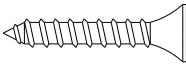



### HARDWARE LIST

1	 Ø5/16" x 12MM <b>NUT</b> 8 PCS	2	 Ø5/16" x 12MM <b>SPRING WASHER</b> 60 PCS
3	 Ø5/16" x 19MM <b>FLAT WASHER</b> 60 PCS	4	 Ø5/16" x 1-1/4" <b>BOLT</b> 4 PCS
5	 Ø1/4" x 2-1/4" <b>BOLT</b> 16 PCS	6	 <b>ALLEN WRENCH</b> 1 PC
7	 <b>ALLEN KEY</b> 1 PC	8	 Ø1/4" x 3" <b>BOLT</b> 16 PCS
9	 Ø1/4" x 1-1/2" <b>BOLT</b> 16 PCS	10	 8MM x 1-1/2" <b>WOOD SCREW</b> 12 PCS

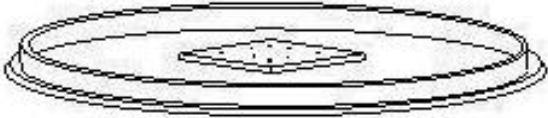
# DA7104B

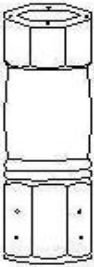
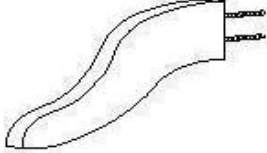
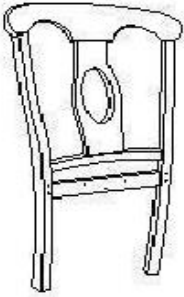
## 5-PC PEDESTAL DINING SET

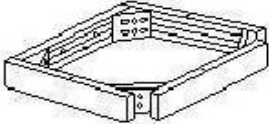
### PARTS LIST

A		B	
<p style="text-align: center;">TABLE TOP 1 PC</p>		<p style="text-align: center;">TABLE BASE PANEL 1 PC</p>	
C		D	
<p style="text-align: center;">CENTER POST 1 PC</p>		<p style="text-align: center;">LEG 4 PCS</p>	
E		F	
<p style="text-align: center;">CHAIR BACK FRAME 4 PCS</p>		<p style="text-align: center;">FRONT LEG 8 PCS</p>	
G		H	
<p style="text-align: center;">SEAT FRAME 4 PCS</p>		<p style="text-align: center;">SEAT BOARD 4 PCS</p>	

# DA7104B

## 5-PC PEDESTAL DINING SET

### STEP 1

Place center post (C) upside down on a clean smooth surface.

Remove the plastic plugs from the legs (D).

Attach legs (D) to the center post (C) using nuts (1), spring washers (2) and flat washers (3).

Fully tighten the nuts (1) with Allen wrench (6).

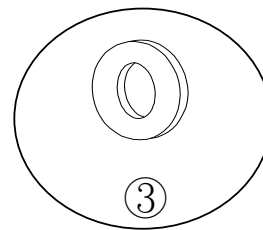
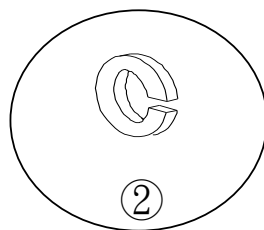
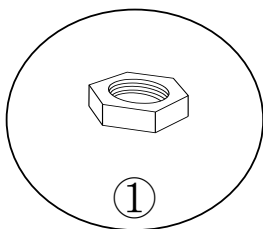
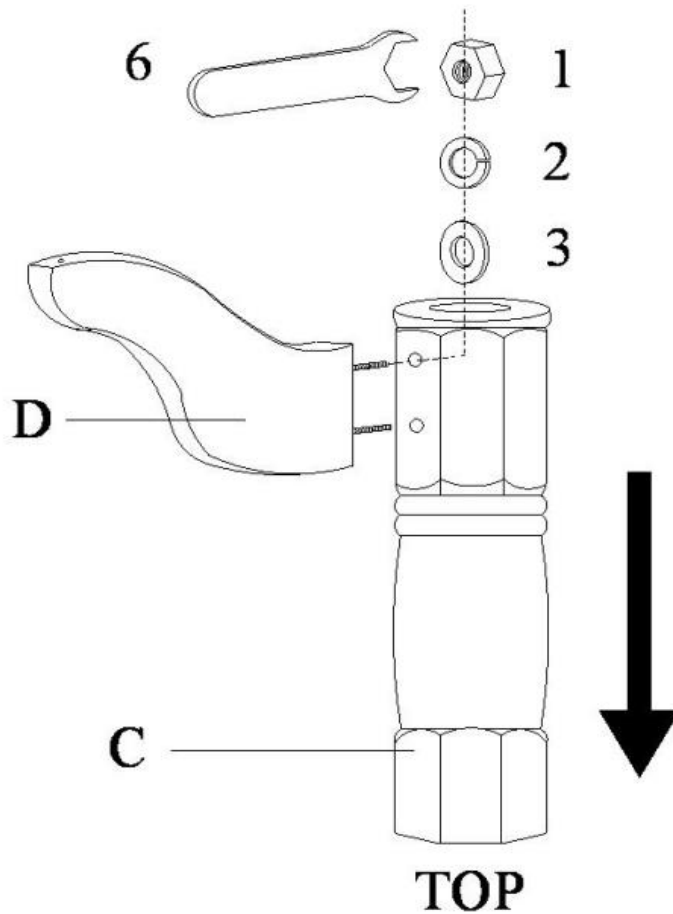
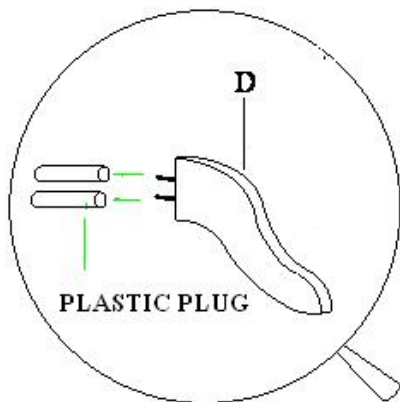

# DA7104B

## 5-PC PEDESTAL DINING SET

### STEP 2

Turn the assembled pedestal upright.

Attach the table base panel (B) to the center post (C) with spring washers (2), flat washers (3) and bolts (4) as shown.

Fully tighten the bolts (4) using Allen key (7).

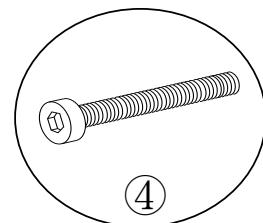
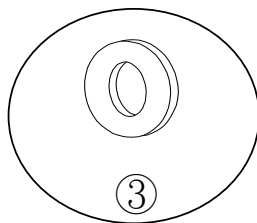
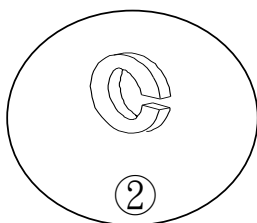
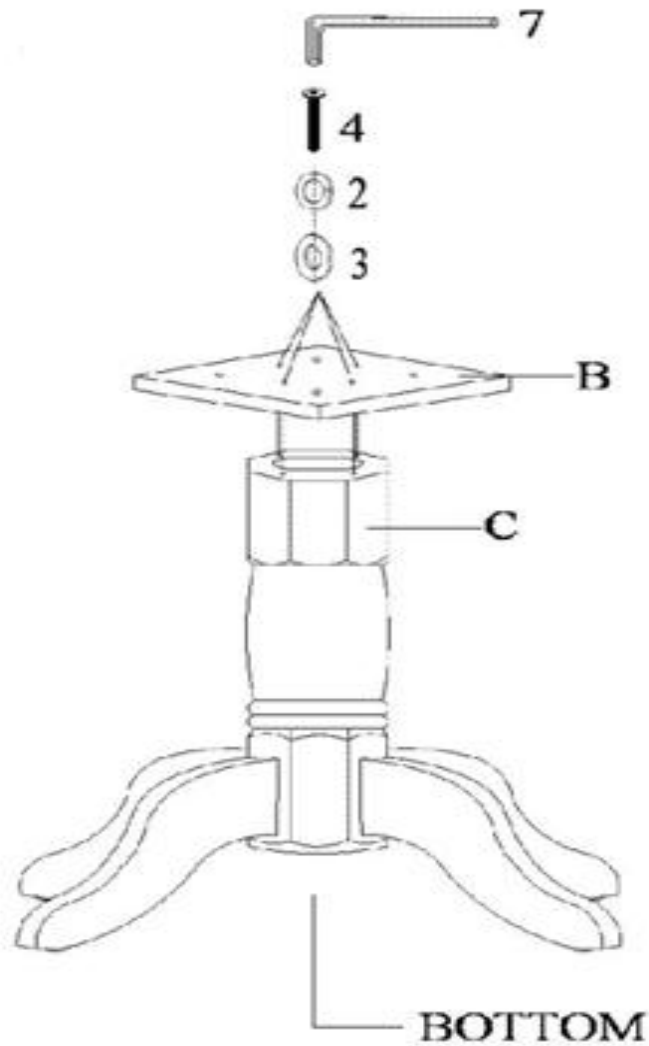

# DA7104B

## 5-PC PEDESTAL DINING SET

### STEP 3

Place the table top (A) upside down on a clean, smooth surface.

Attach the table pedestal (assembled in the previous step) to the table top (A) using spring washers (2), flat washers (3) and bolts (9) as shown.

Fully tighten the bolts (9) using Allen key (7).

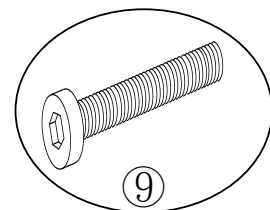
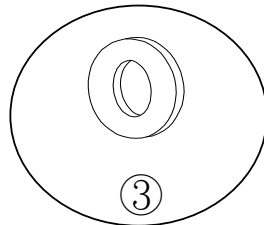
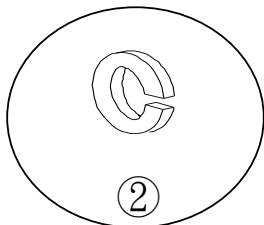
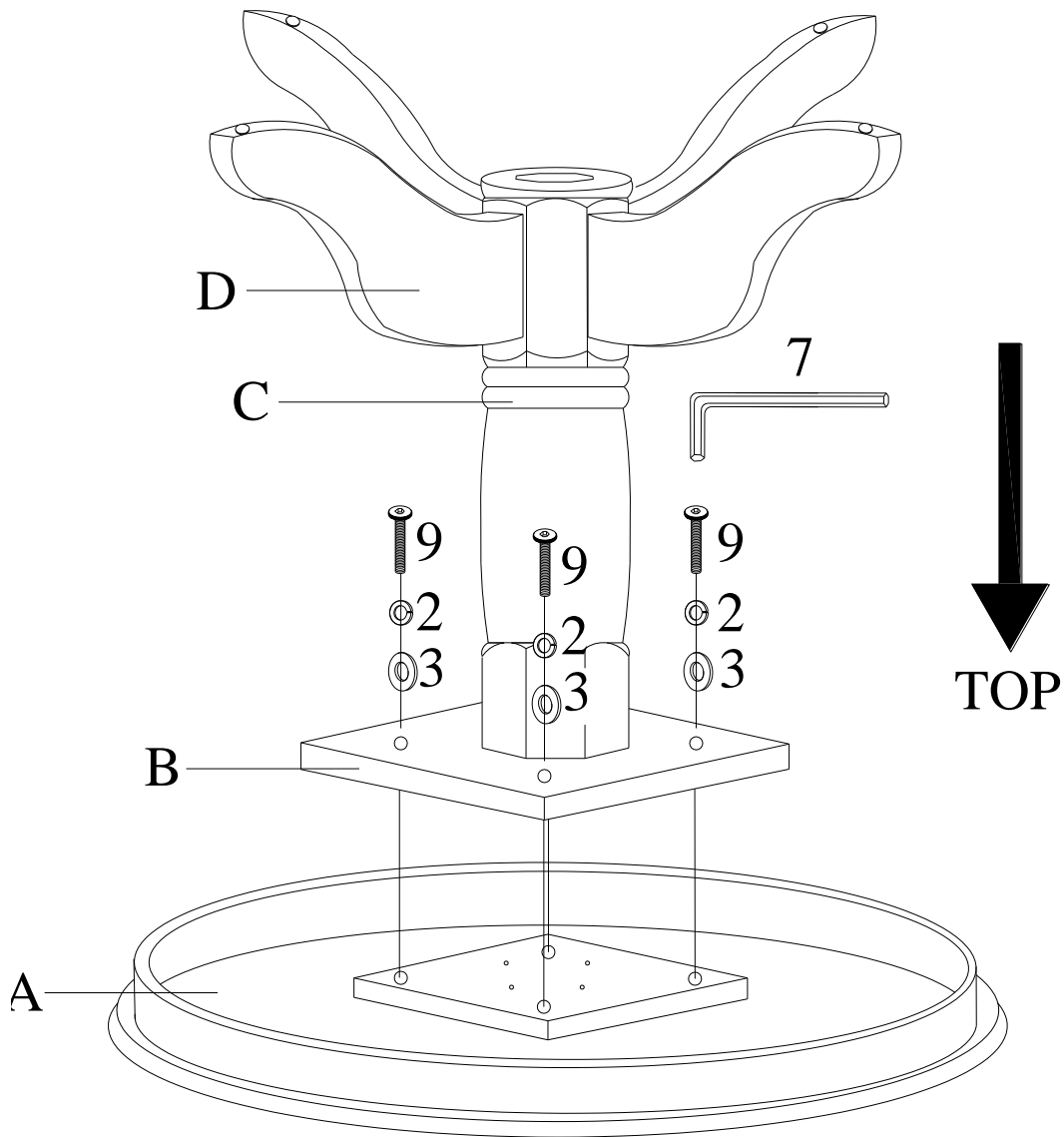

# DA7104B

## 5-PC PEDESTAL DINING SET

### STEP 4

Turn the table upright.

Adjust the levelers underneath each leg to ensure that the table level with the floor both vertically and horizontally.

You've finished assembling the dining table.

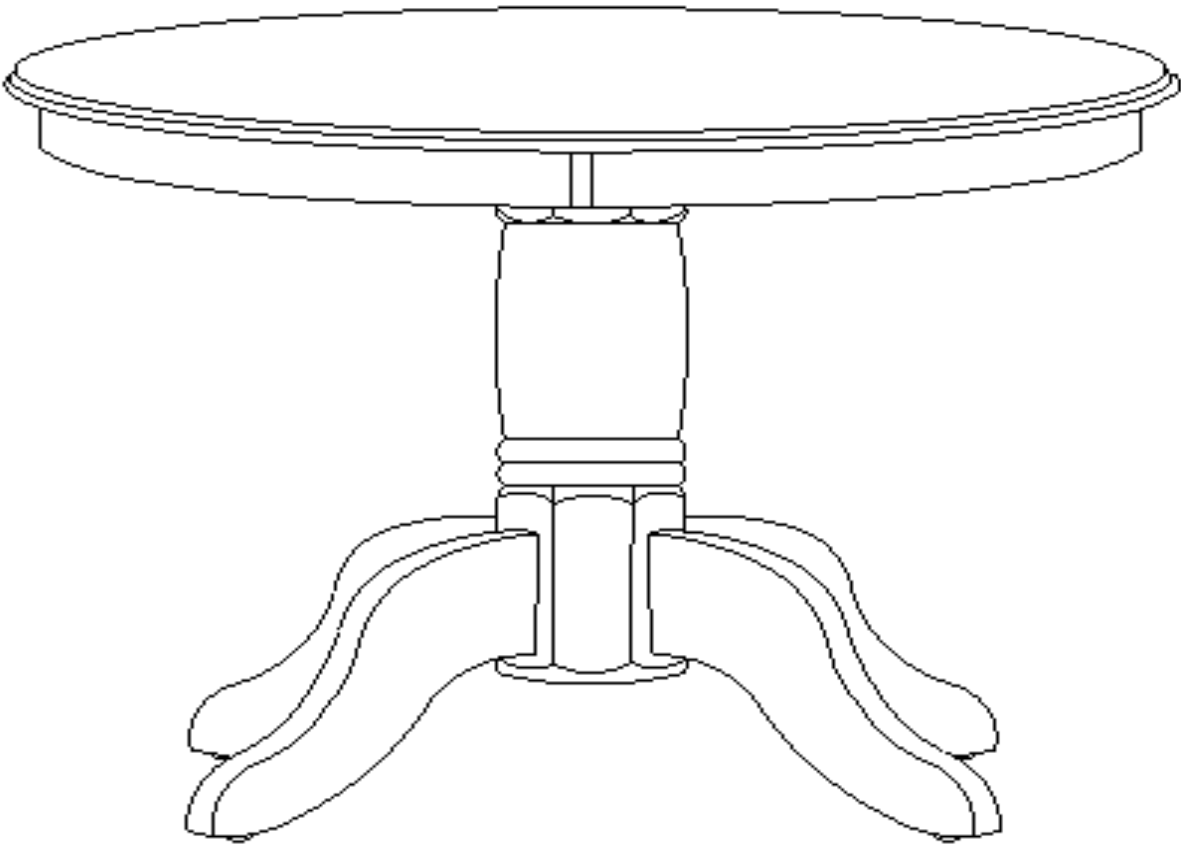



# DA7104B

## 5-PC PEDESTAL DINING SET

### STEP 5

Attach the front legs (F) to seat frame (G) with spring washers (2), flat washers (3) and bolts (5) using Allen Key (7).

NOTE: Do not fully tighten the bolts in this step.

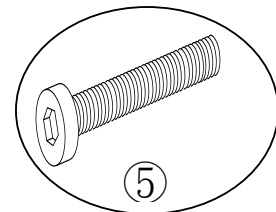
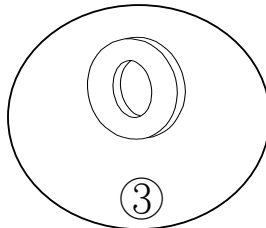
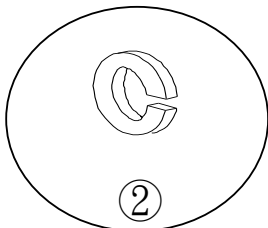
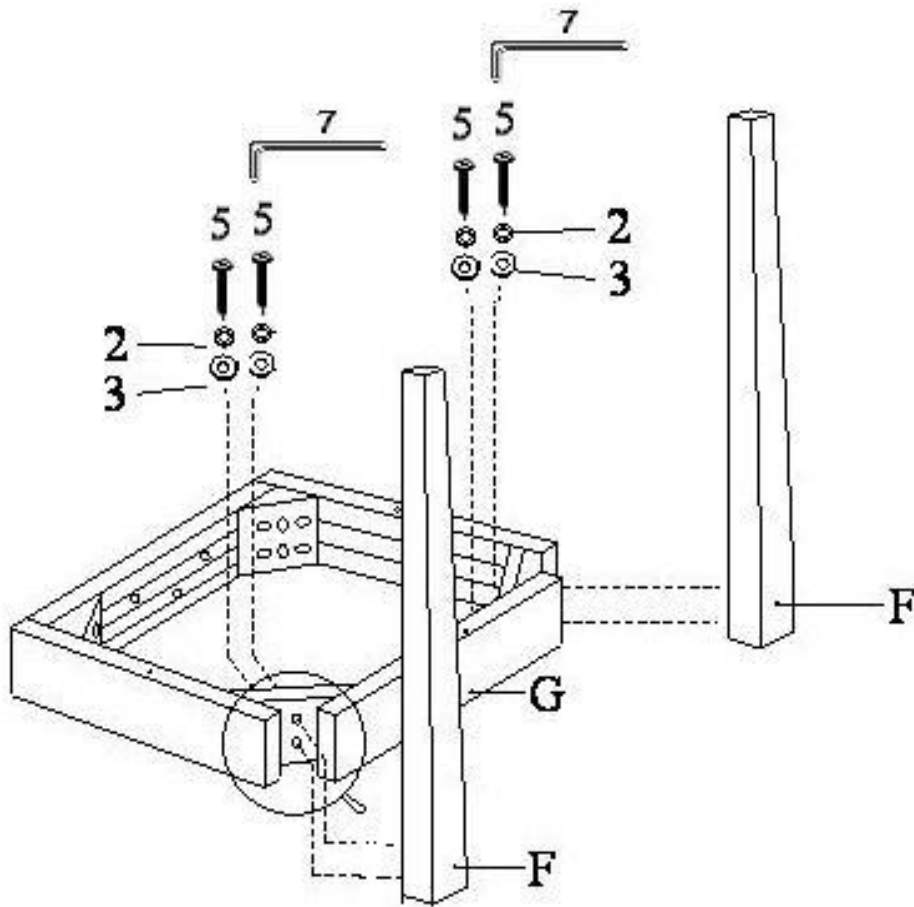

# DA7104B

## 5-PC PEDESTAL DINING SET

### STEP 6

Attach the assembled seat frame (G) to the chair back frame (E) using bolts (8), spring washers (2) and flat washers (3) at the corners of the seat frame (G).  
Use bolts (9), spring washers (2) and flat washers (3) at the center of seat frame (G) to secure it to chair back frame (E) as shown.  
Use Allen Key (7) to tighten the bolts (8 & 9).  
NOTE: Do not fully tighten the bolts in this step.

Turn the chair frame upright.

Fully tighten all bolts previously installed.

NOTE: Make sure that the chair levels with the floor both vertically and horizontally before tightening all bolts.

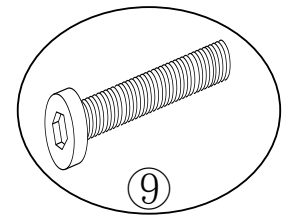
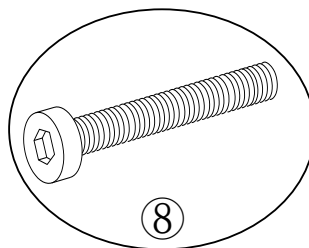
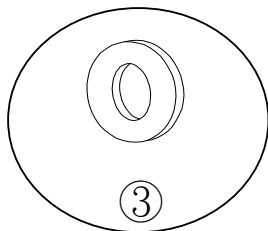
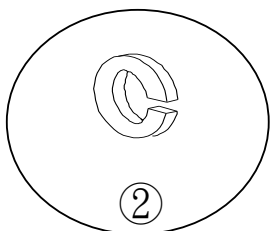
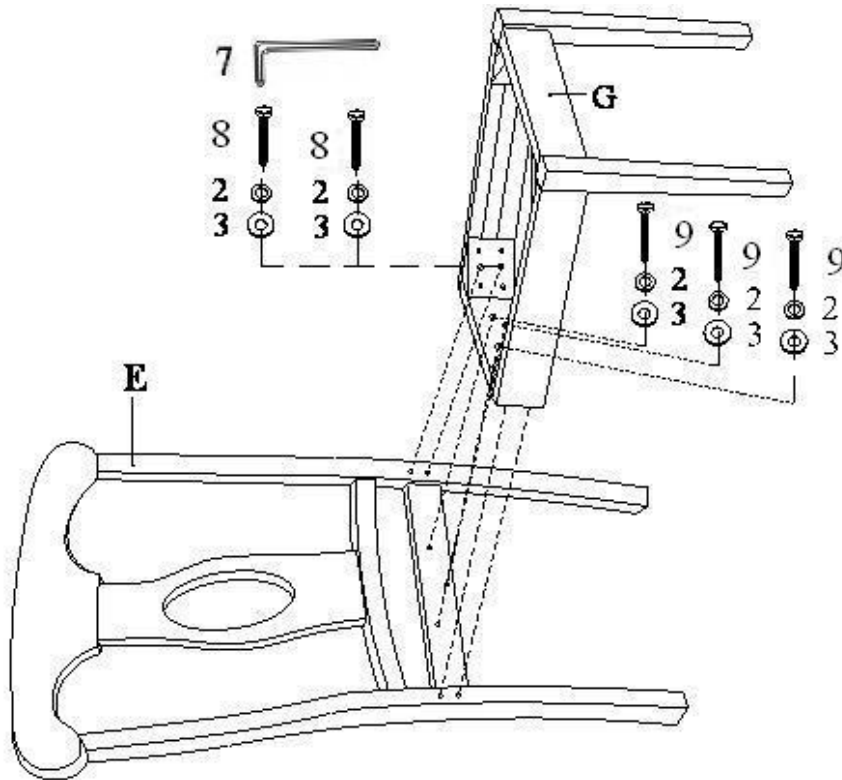

# DA7104B

## 5-PC PEDESTAL DINING SET

### STEP 7

To facilitate the attachment of the seat board (H) to the assembled seat frame, place seat board (H) on the table surface as shown.

(Protect the smooth table surface and seat board (H) by laying a towel between the seat board (H) and the table.)

Attach the seat board (H) to the chair frame with wood screws (10) using a Phillips head screw driver (not included).

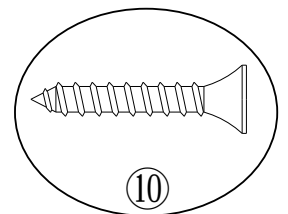
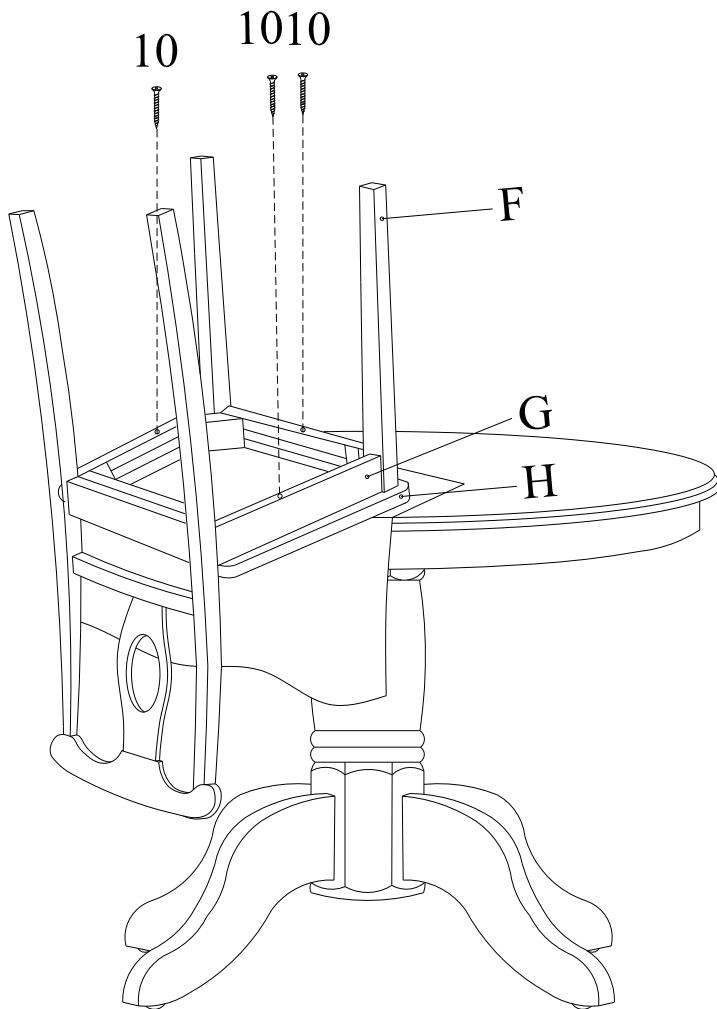

# DA7104B

## 5-PC PEDESTAL DINING SET

### STEP 8

Turn the chair upright.

Repeat Steps 5-7 to assemble the other 3 chairs.

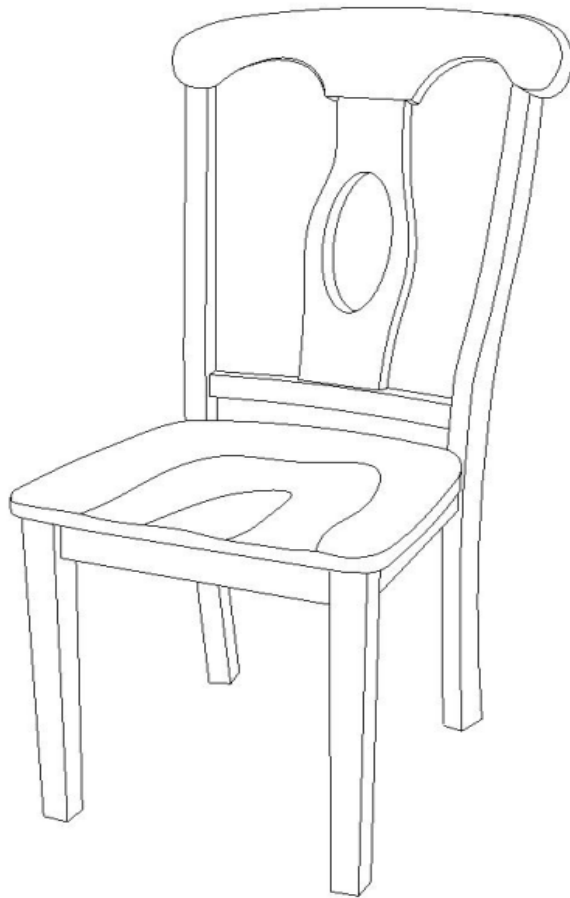

# DA7104B

## 5-PC PEDESTAL DINING SET

 **CAUTION:** This unit is intended for use only with the products and/or maximum weights indicated. Use with other products and/or products heavier than the maximum weights indicated may result in instability or cause possible injury.

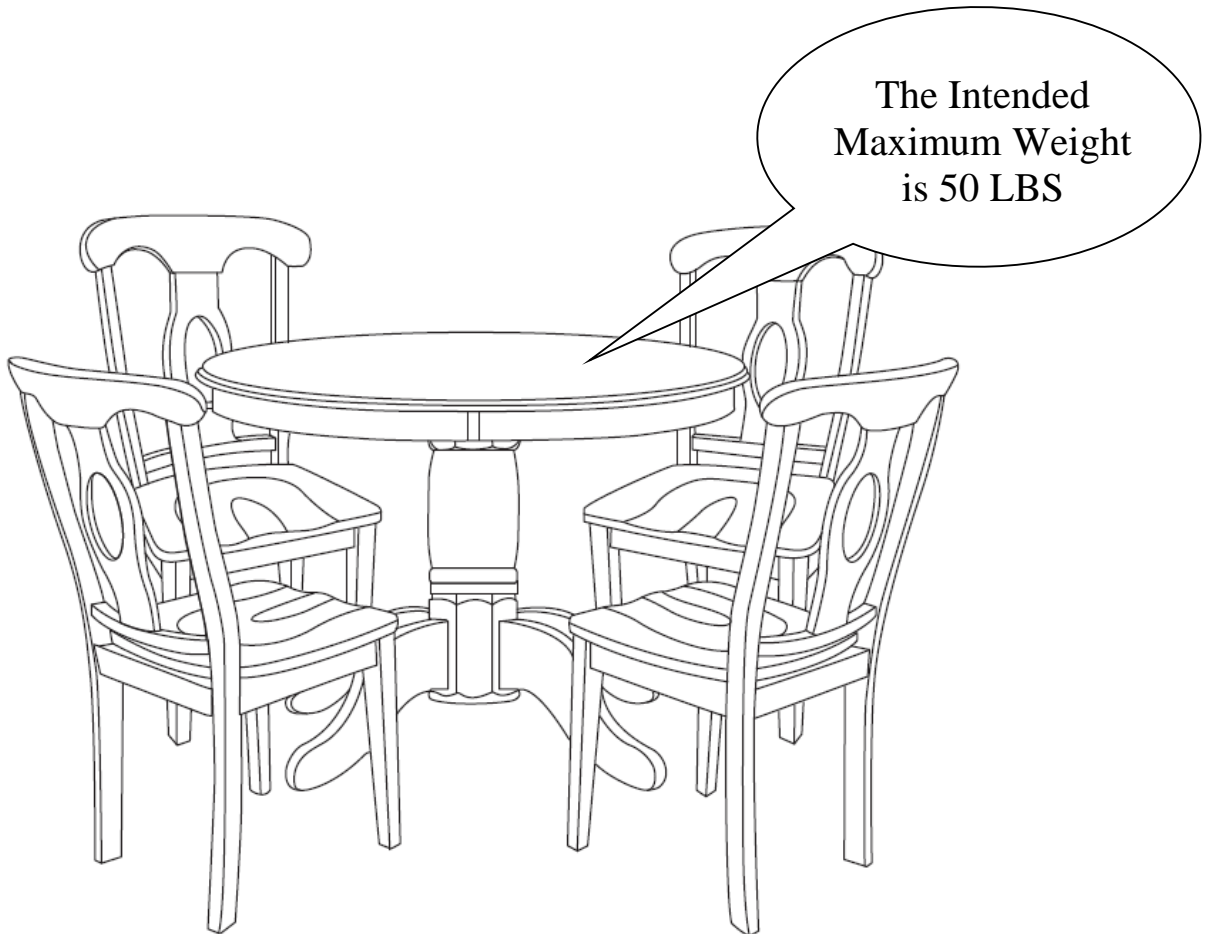

That's it ! You've finished assembling your dining set.

**DO NOT RETURN PRODUCT TO THE STORE.**

If a part is missing or damaged, contact our customer service department. We will replace the part **FREE** of charge.



Tel #: 1-800-295-1980  
E-Mail: [das@dorel.com](mailto:das@dorel.com)  
Fax #: 514-353-7819

# Customer Service

**PLEASE DO NOT RETURN THIS PRODUCT TO THE STORE**

**PLEASE CONTACT CUSTOMER SERVICE REPRESENTATIVES AT THE FOLLOWING NUMBERS SHOULD THERE BE ANY MISSING OR DEFECTIVE PART(S).**

Customer Service Phone Number 1-800-295-1980	Email: <a href="mailto:das@dorel.com">das@dorel.com</a>
Customer Service Fax Number 514-353-7819	

Request Date:

Name:

Shipping Address:

Street & Number:

City & State:

Zip Code:

Day Time Phone Number:

(including area code)

Date & Place of Purchase:

Part(s) description and quantity (Please be sure to list model number or SKN number):

Customer Service Representative Mailing Address:

Customer Service Department No. 413, 12345 Albert-Hudon Boulevard, Suite 100, Montreal, QC, Canada, H1G 3L1