

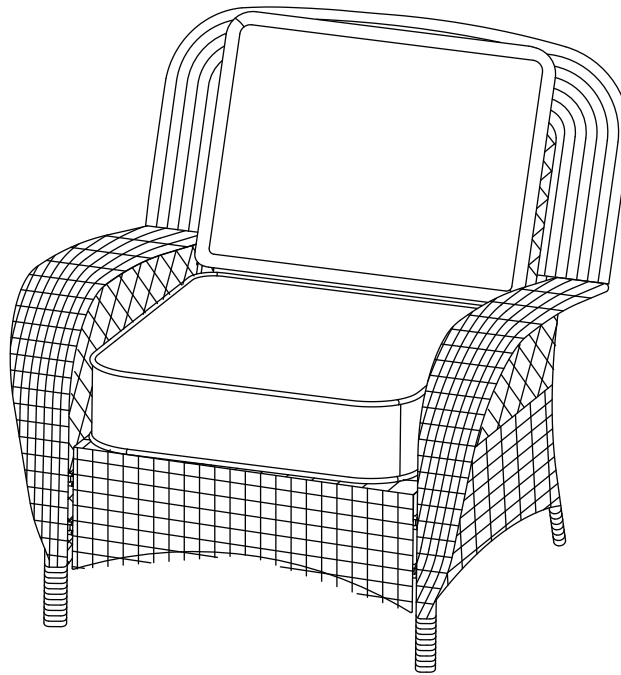

Item # 1002 658 201
Model # FRS80812C

USE AND CARE GUIDE

BEACON PARK STATIONARY CHAIR



Questions, problems, missing parts? Before returning to the store,
call Hampton Bay Customer Service.
8 a.m. - 7 p.m., EST, Monday - Friday, 9 a.m. - 6 p.m., EST, Saturday

1-855-HD-HAMPTON

HAMPTONBAY.COM

THANK YOU

We appreciate the trust and confidence you have placed in Hampton Bay through the purchase of this chair. We strive to continually create quality products designed to enhance your home. Visit us online to see our full line of products available for your home improvement needs. Thank you for choosing Hampton Bay!

Table of Contents

Table of Contents.....	2	Pre-Assembly	3
Important Safety Instructions	2	Planning Assembly	3
Save These Instructions	2	Hardware Included	3
Read All Instructions Before Use	2	Package Contents	4
Warranty	3	Assembly	5
What is Covered	3	Care and Cleaning	9
What is Not Covered	3		

Important Safety Instructions

SAVE THESE INSTRUCTIONS



WARNING: This stationary chair was made for the explicit purpose of providing outdoor functions and is not to be used as a toy. This product is intended for normal outdoor use; however, the manufacturer recommends storing and / or covering this set when any formidable / severe weather is approaching.



WARNING: Do not locate this product near open flames. Do not use this product as a support. Do not shake, lean or climb on the product. Children under the age of 10, near the product, should be supervised by a competent adult at all times. This product is NOT intended for commercial use and will void the warranty.

READ ALL INSTRUCTIONS BEFORE USE

To reduce the risk of injury to persons:

1. Close supervision is necessary when this product is used by or near children, or disabled persons, if applicable.
2. Use this product only for its intended use as described in these instructions. Do not use attachments not recommended by the manufacturer.
3. Do not move the chair while the chair is occupied. Failure to obey this caution could result in injury.
4. Do not rock in the chair as you may fall and cause serious injury.
5. Please keep children out of the assembly area before assembly.



WARNING: Do not place heavy objects on the chair.



WARNING: Weight limit for chair is 250 lbs (113.39 Kg) for each seat.



WARNING: This chair unit is heavy, and may require two adults for safe assembly.



CAUTION: Do not locate the product near any heat source.

Warranty

2 YEAR FRAME AND 2 YEAR FABRIC LIMITED WARRANTY

WHAT IS COVERED

We warrant the frames to be free of manufacturing defects to the original purchaser for two years, and a two year limited warranty for the fabric.

WHAT IS NOT COVERED

It remains the customer's responsibility for freight and packaging charges to and from our service center. This warranty does not cover commercial use, hardware, acts of nature, fire, freezing and abusive use. In addition, purchased parts are not covered under this warranty. We reserve the right to make substitutions with similar merchandise, if the model in question is no longer in production.

Contact the Customer Service Team at 1-855-HD-HAMPTON or visit www.Hamptonbay.com

Pre-Assembly

PLANNING ASSEMBLY

Read all instructions before assembly.

To avoid damaging this product, assemble it on a soft, non-abrasive surface such as carpet or cardboard.



NOTE: More than one person may be required to assemble this product.

HARDWARE INCLUDED



NOTE: Hardware not shown to actual size.



AA



BB



CC

Part	Description	Quantity
AA	M6x20 combination bolt	6+1
BB	M6x50 combination bolt	4+1
CC	Hex wrench	1

Pre-Assembly (continued)

PACKAGE CONTENTS

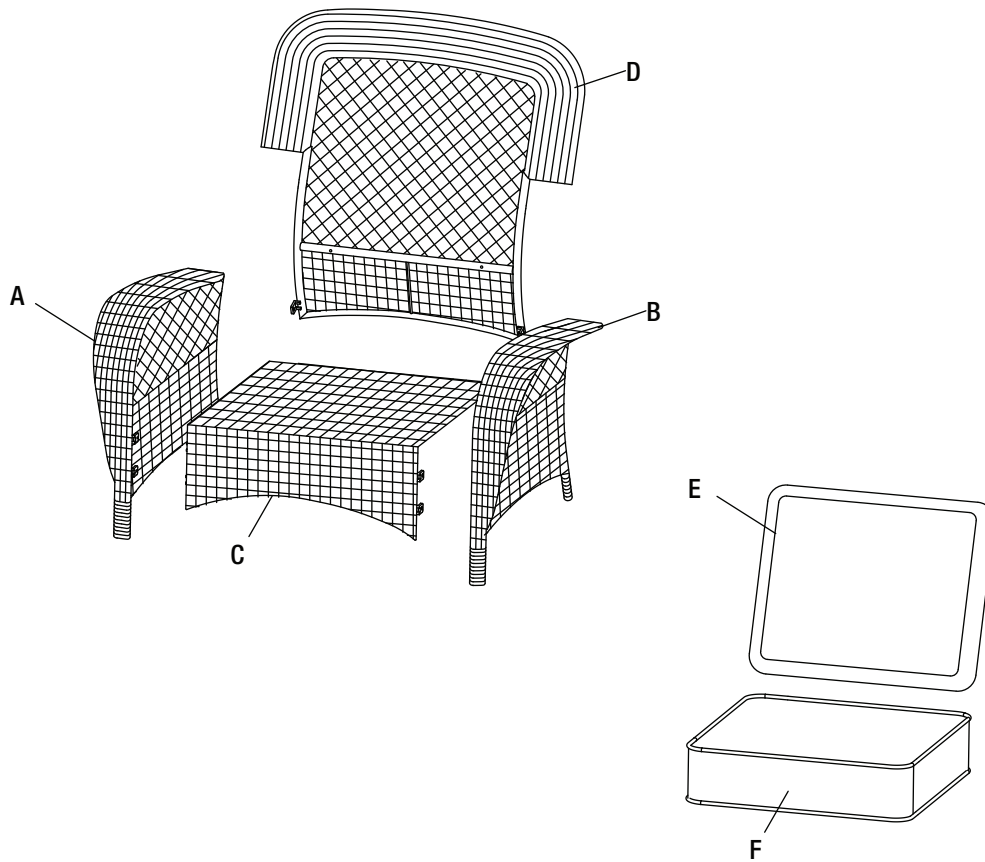

Part	Description	Quantity
A	Right arm	1
B	Left arm	1
C	Seat	1
D	Backrest	1
E	Back cushion	1
F	Seat cushion	1

Assembly

1 CONNECTING THE RIGHT ARM TO THE SEAT

- Place the right arm (A) on a soft surface.
- Align the holes on the right panel of the seat (C) to the holes on the front of the right arm (A), and secure by M6x20 combination bolts (AA).
- Do not fully tighten all bolts at this step.

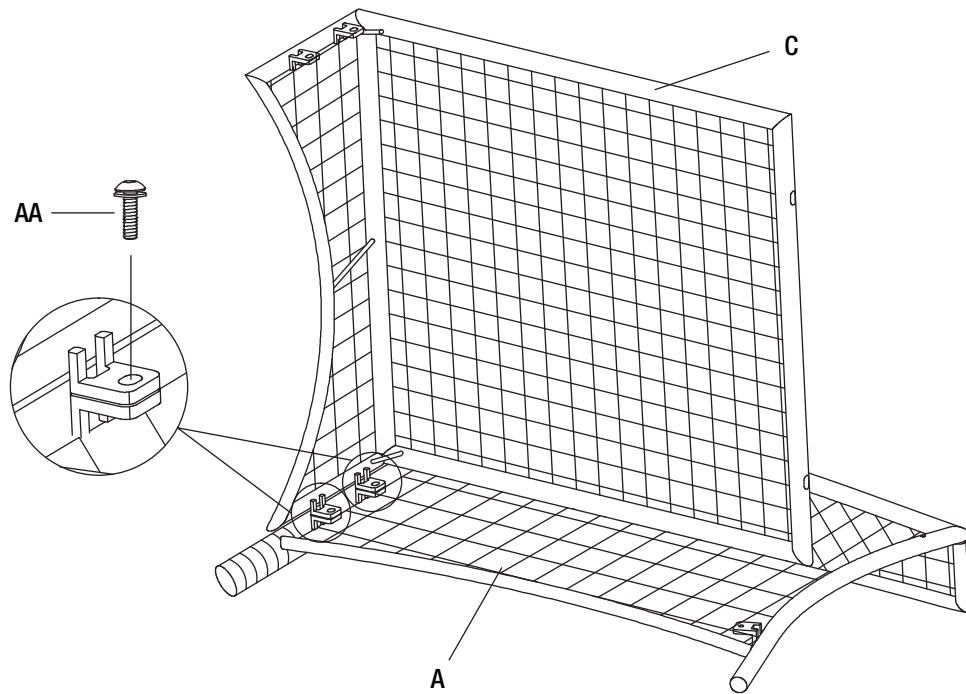

Assembly (continued)

2 ATTACHING THE BACKREST TO THE SEAT AND THE RIGHT ARM

- Attach the backrest (D) to the right arm (A) and the seat (C), using an M6x20 combination bolt (AA) and M6x50 combination bolts (BB).
- Do not fully tighten all bolts at this step.

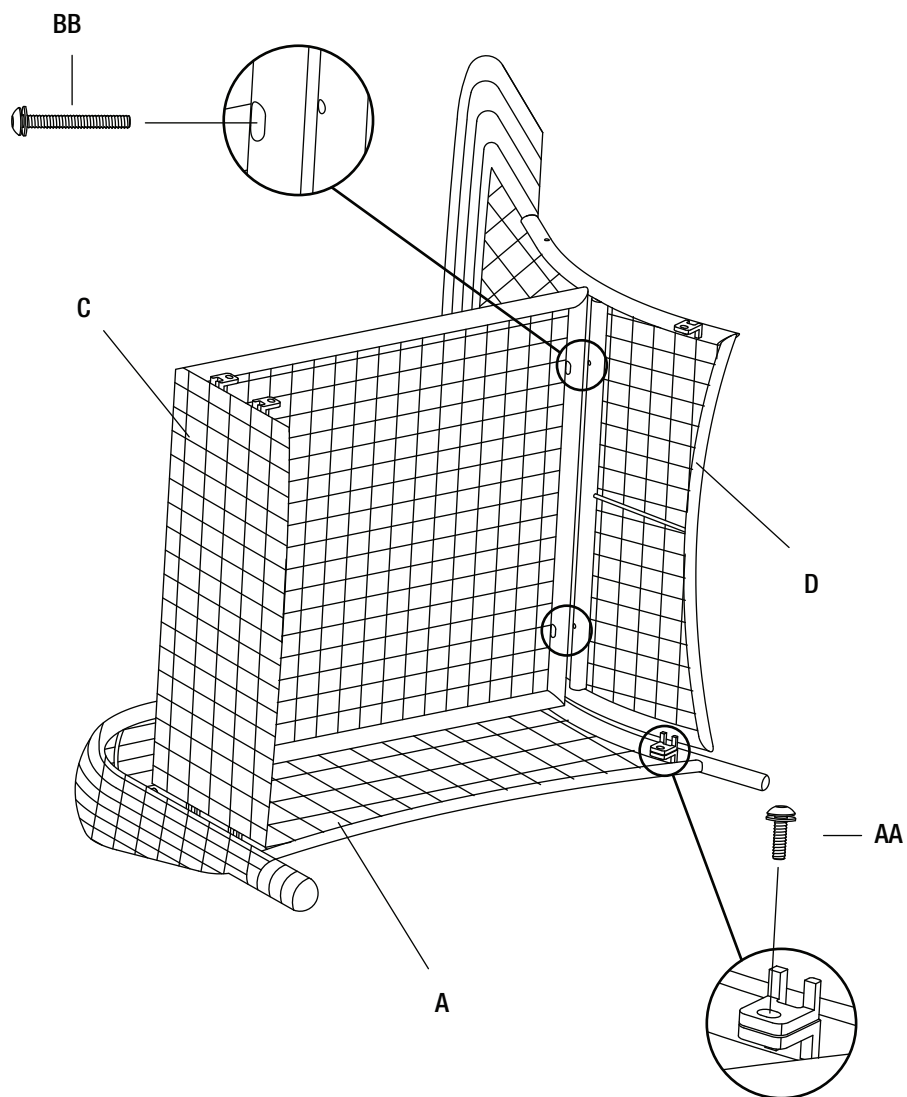

Assembly (continued)

3 CONNECTING THE LEFT ARM TO THE SEAT AND THE BACKREST

- Connect the left arm (B) to the seat (C) and the backrest (D) using M6x20 combination bolts (AA).
- Do not fully tighten all bolts at this step.

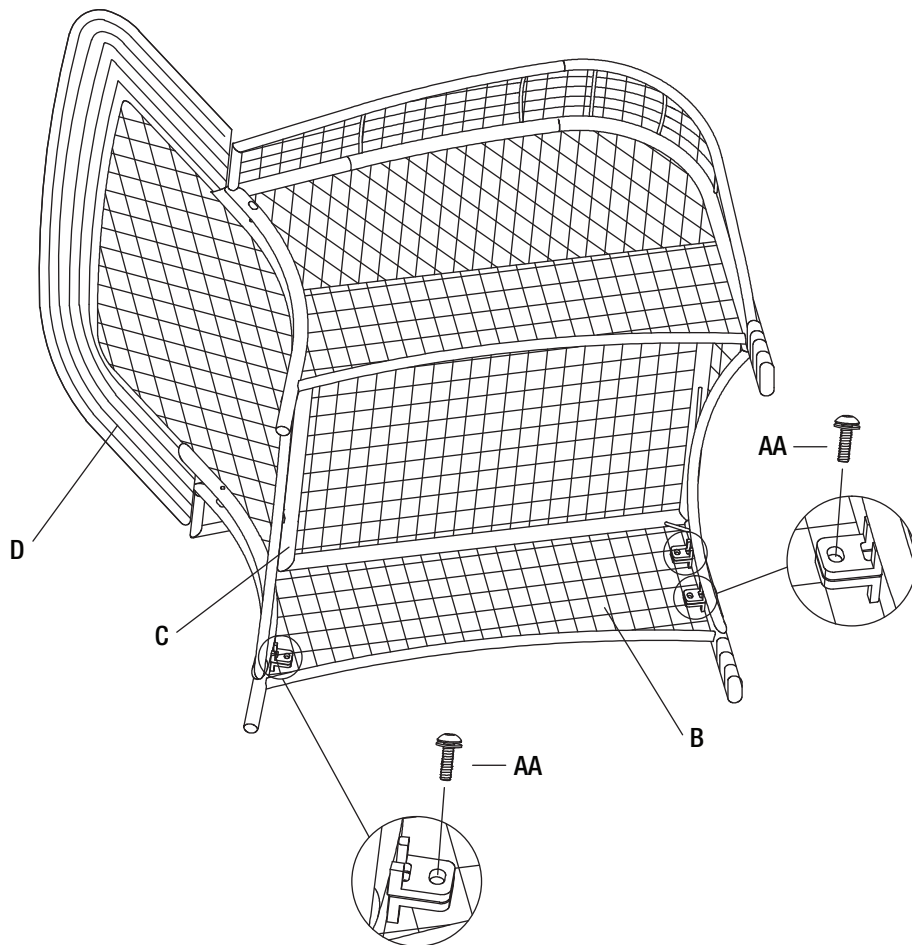

Assembly (continued)

4 CONNECTING THE ARMS TO THE BACKREST

- Turn the chair right side up.
- Connect the back of the right and the left arm (A & B) to the backrest (D) by using M6x50 combination bolts (BB).
- Do not tighten all the bolts at this step.

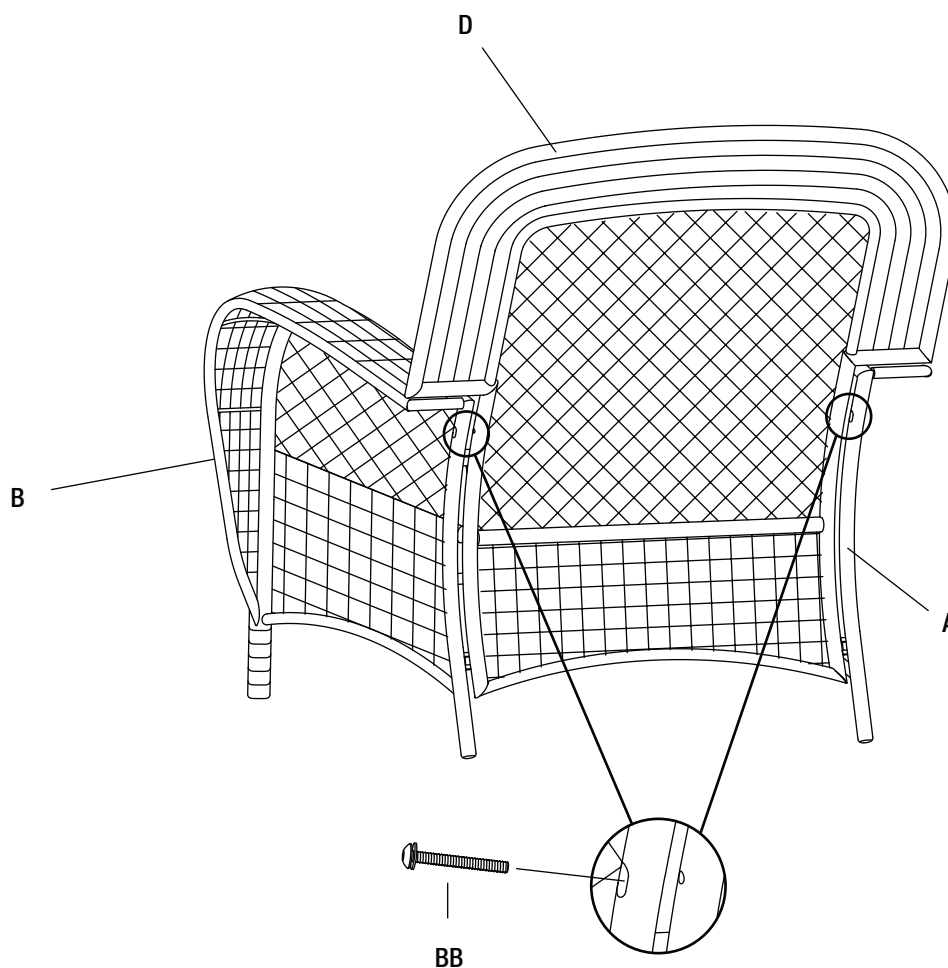

Assembly (continued)

5 TIGHTENING THE BOLTS

- Once all of the bolts are in place, fully tighten the bolts using the hex wrench (CC).
- Place the seat cushion (F) and the back cushion (E) to finish the assembly of the chair.
- Ensure all connections are secure before use.

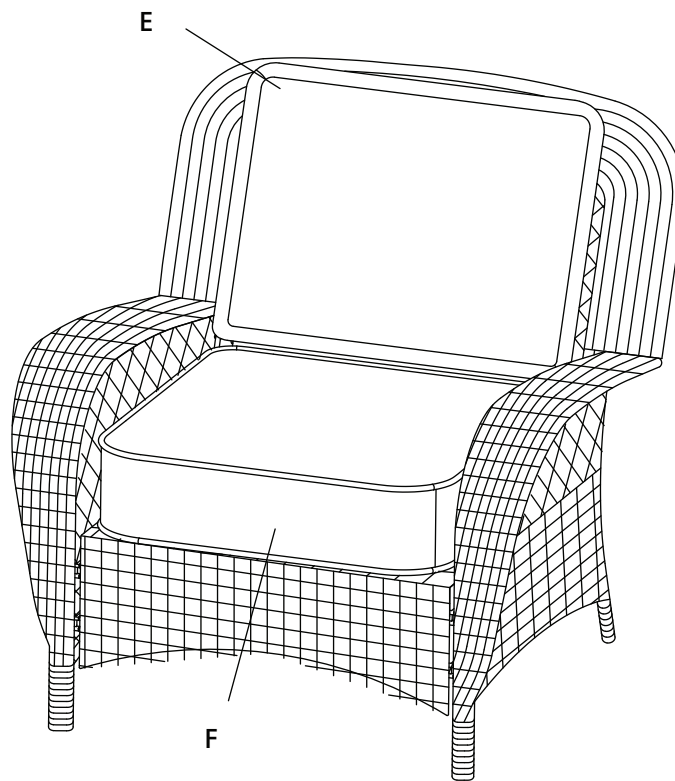

Care and Cleaning

- For best results, clean the chair with a damp cloth and dry thoroughly. This will help prevent mildew by removing dirt particles that may accumulate.
- Do not clean with abrasive materials, bleach, or solvents.
- Store the chair in a dry, sheltered place when not in use.
- Keep the chair away from fire, extreme heat, freezing conditions, and inclement weather such as rain, hail, sleet, snow, or wind.



Questions, problems, missing parts? Before returning to the store,
call Hampton Bay Customer Service.
8 a.m. - 7 p.m., EST, Monday - Friday, 9 a.m. - 6 p.m., EST, Saturday

1-855-HD-HAMPTON

HAMPTONBAY.COM

Retain this manual for future use.

For certification use only
Factory chair ID # FRS80812C