

gorilla

playsets



Malibu Extreme Clubhouse

Timber Shield Post Option
BOXES: X1, 120

Model: 1500CWCR

(BOXES: 1501, 1512, 1518,
1528, 1529, Extreme Tube Slide
Box, & Slide Box)

Amber Post Option
BOXES: 1533-2bx, 1522

Copyright © 2016 Gorilla Playsets
All Rights Reserved



51-0073-W

190 Etowah Industrial Court
Canton, GA 30114

www.gorillaplaysets.com

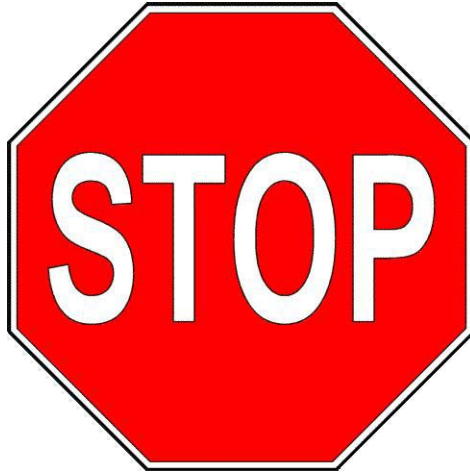

Please inspect and inventory all parts immediately upon accepting delivery. Use the inventory pages in the manual to make sure you have received all necessary parts. The quickest method to get any parts that are missing or damaged is to use our “Quick Response Center” located at:

www.gorillaplaysets.com/support

DO NOT RETURN THIS PRODUCT TO THE RETAILER OR CONTACT THE RETAILER DIRECTLY. THE RETAILER DOES NOT STOCK COMPONENTS.

PLEASE RETAIN ALL INSTRUCTIONS FOR FUTURE REFERENCE. KEEP THEM IN A SAFE PLACE WHERE YOU CAN REFER TO THEM AS NEEDED. CHECK FOR REVISED INSTRUCTIONS AT:

www.gorillaplaysets.com/manuals

GORILLA PLAYSETS WARRANTY – 2016

Gorilla Playsets® (“Gorilla”) warrants its play sets to be free from defects in workmanship and materials, under normal use and conditions, for 10 years for above ground structural wood components and for one year for all other components (e.g., swings, hardware, plastics, tarps, rope ladder, etc.).

Gorilla warrants all remaining products, including but not limited to its , Free Standing Swing Set, Free Standing Tire Swing, See-Saw, Children’s Picnic Table with Umbrella, Play-Zee-Bo™, Cedar Toy Chest and spring riders to be free from defects in workmanship and materials, under normal use and conditions, for a period of 1 year.

Cosmetic imperfections and natural tendencies of wood such as peeling, splintering, warping, seasonal checking or cracking, knots or knot holes, etc. are normal characteristics of all outdoor wooden play equipment and are not covered by this warranty. Checks or cracks in wood components that do not affect the intended function of the part, piece or overall swing set are not covered under this warranty.

Wood rot or decay that develops because the product was installed in an area with poor drainage is not covered under this warranty. Lumber that has been damaged by wood boring bees, or conditions that develop as a result of faulty or improper installation of the product, are not covered by this warranty. Fading of stain, discoloration or mold on any wood part or accessory is not covered by this warranty. Cracks in plastic components, surface rust on hardware and chips on powder coated materials are not considered defects in material as long as they do not affect the functionality or structural integrity of the part or component.

It is the owner’s responsibility to maintain the swing set. **This includes but is not limited to staining and sealing the lumber as needed and regular inspection to be sure all hardware is tight.** Instructions for proper maintenance can be found on Gorilla’s website. Imperfections or conditions that develop because of a failure to properly maintain the swing set are not covered by this warranty.

Gorilla will, at its discretion, replace any above ground part within the stated warranty period that is defective in workmanship or materials. This decision is subject to verification of the defect, which, at Gorilla’s discretion, may be accomplished by submitting photographs or by delivery of the defective part to Gorilla Playsets • 190 Etowah Industrial Ct. • Canton, GA 30114 • 1-800-882-0272 Monday to Friday 9AM-5PM EST. Any warranty claim must include proof of purchase, including the date of purchase. **In addition, within the first 30 days from the date of purchase, Gorilla will replace any parts discovered to be missing from or damaged in the original packaging.**

This warranty is valid only if the product is used for the purpose for which it was designed and installed at a residential, single-family dwelling. This warranty is void if the product is used in a commercial, institutional or multi-family setting. **This warranty does not cover normal wear and tear or (a) products that have been damaged by acts of God and/or nature, negligence, misuse or accident; (b) products that have been modified or repaired by unauthorized persons; (c) the cost of labor; or (d) the cost of shipping any replacement product or part.**

GORILLA DISCLAIMS ALL OTHER REPRESENTATIONS AND WARRANTIES OF ANY KIND, EXPRESSED, IMPLIED, STATUTORY OR OTHERWISE, INCLUDING THE IMPLIED WARRANTIES OF MERCHANTABILITY AND FITNESS FOR A PARTICULAR PURPOSE. GORILLA WILL NOT BE LIABLE FOR ANY INCIDENTAL OR CONSEQUENTIAL DAMAGES. This warranty is non-transferable and does not extend to the owners of the product subsequent to the original purchaser. Some states do not allow limitations on implied warranties or exclusion of incidental or consequential damages, so these restrictions may not be applicable to you. This warranty gives you specific legal rights. You may also have other rights which vary from state to state.

IMPORTANT SAFETY GUIDELINES

This product is recommended for use by children ages 3-11. This product is intended for residential use only and not intended for use in any public setting. A safety surface such as mulch or recycled tire should be used under the play set to prevent injury from falls. Also a 6 foot safety zone should be used around the entire play set.

As with any home project, good judgment and respect for power tools will greatly reduce the risk of injury. Gorilla recommends you follow all tool manufacturers' safety guidelines. Always wear eye protection and safety gloves to prevent injury. In several phases of construction two people may be required for lifting and securing of lumber. While the play set is being constructed, please keep children off the equipment until the project is complete. Bolts and screw heads should be checked regularly for tightness. The ground ladder, rope ladder, slide, swings and other areas where children spend a majority of their playtime should be checked more frequently.

Gorilla shall not be liable for incidental, indirect or consequential damages or injuries that result from building and/or playing on our play sets. Adult supervision is recommended anytime a play set is being used.

WEIGHT LIMITS FOR GORILLA PLAYSETS

- FORT PLATFORMS: 800 LBS. TOTAL WEIGHT
- SWING BELT: 225 LBS.
- TANDEM SWINGS: 70 LBS. PER CHILD. UP TO 140 LBS. TOTAL WEIGHT.
- TRAPEZE: 125 LBS.
- FULL BUCKET SWING/ HALF BUCKET SWING: 50 LBS.
- HEAVY DUTY TODDLER BUCKET SWING: 85 LBS.
- INFANT SWING: 35 LBS.
- TIRE SWING: 125 LBS. TOTAL WEIGHT
- ROPE LADDER: 75 LBS.
- ROCK WALL: 150 LBS.
- CLIMBING RAMP: 150 LBS.
- MONKEY BARS: 175 LBS.
- ALL SLIDES: 150 LBS.

Gorilla recommends that the weight limits for all components must not be exceeded. Failure to adhere to these and other safety guidelines could result in damage to the play set and injury to the users.

THIS PAGE INTENTIONALLY LEFT BLANK

IMPORTANT – PLEASE READ

Congratulations! You have just purchase one of the finest residential wooden swing sets available today. As with any wooden product that spends its entire life outside, in varying elements, it is important to know what to expect with your new swing set so that your family can enjoy it for many years.

As your swing set acclimates to its new environment, natural characteristics of the wood can show in the form of checks, or “cracks” in the lumber. In almost all cases this is normal and it will not affect the structural integrity of your play set and is not covered under warranty.

KEEPING YOUR PLAYSET LIKE NEW

MUST DO's

The following owner responsibilities are crucial to the safety, integrity and aesthetic appeal of your swing set and may affect the warranty if not adhered to.

WITHIN 60 DAYS

- Check and tighten Hex Bolts/T-nuts, Carriage Bolts/Lock-nuts, and Lag Screws within the first 60 days and then twice annually – once before each season and then once during the season.

WITHIN 90 DAYS

- Apply a **sealant** or **semi-transparent stain with sealant** within the first 90 days of owning the swing set. Our own Stain/sealant is available online here: <http://www.gorillaplaysets.com/Playground-Sealant-p/10-0003.htm>

Oil based stain or water based stain may be used. Should you choose to use other stain we suggest asking the product covering specialists at any number of specialty paint stores or home improvement centers for a product that would work best for your local environment. ** TIP – while the set is new, take a small board from the store with you so they can color match the tint of the stain or sealant.

SEASONAL REMINDERS

- If your area experiences regular snowfall, remove your fabric tarp/canopy to avoid stretching, sagging or tearing of the material. Store it inside, folded up, and it will be as good as new when winter is over.
- If your area experiences extremely cold temperatures, remove swing belts and other pliable features to prolong the lifespan of these play activities.

OTHER TIPS

- Spray swing hangers with Pam, Mazola or olive oil to stop squeaking; do not use petroleum based products such as WD-40 or motor oil.
- To repel yellow jackets and wasps, use a cotton ball and dab interior wooden corners underneath the play set deck with a liquid dish soap. Avoid using insecticides.
- To speed up the slide wipe the center of slide with wax paper every 2 - 3 weeks.

For additional safety and maintenance guidelines, please visit our website.



IMPORTANT DOCUMENTS

CUSTOMER MUST READ AND RETAIN

Please go to the following links and read important **SAFETY** information prior to using your new play structure.

<http://www.gorillaplaysets.com/Swing-Set-Safety-s/85.htm>

<https://www.gorillaplaysets.com/Maintenance-s/129.htm>

<http://www.gorillaplaysets.com/manuals.html> (Click on your specific model)

<http://www.gorillaplaysets.com/Warranty-s/82.htm>

NOTE: Your children's safety is our #1 concern. Observing the following statements and warnings reduces the likelihood of serious injury. Please review these safety rules regularly with your children.

WARNING:

Children must NOT use this play set until it has been completely assembled and inspected by an adult to ensure it has been properly installed.

Gorilla Playsets
190 Etowah Industrial Court
Canton, GA. 30114

FRONT VIEW



REAR VIEW



1518 Clubhouse Walls

FOR MODELS:

(1500CWC/1500CWCF/1500CWCR/1500CTC)

!!READ ME FIRST!!

The Clubhouse Walls for this unit will require removal of some boards to install the walls. There will be some boards that will be leftover after the walls are installed.

Have you assembled your play set?

If “yes”, then READ the Leftover Parts notes at the bottom of this page, then turn the page and proceed.

If “no”, then keep reading below.

If you have NOT already assembled your play set then you will need to do the following as you are building your play set:

- 1) DO install the angle supports in Step 6B of the main instruction manual. These will help stabilize the structure as construction progresses to the end.
- 2) DO NOT install the Safety Board in Step 33 (Side to Side Roof), Step 42 (Front to Back Roof) or Step 31 (Tarp Roof) of the main instruction manual.
- 3) DO NOT install the Sandbox Seats in Step 47 (Side to Side Roof), Step 55 (Front to Back Roof) or Step 44 (Tarp Roof) of the main instruction manual.
- 4) DO install the Clubhouse Walls after the entire play set structure is completed.
- 5) DO NOT build the picnic table until after the clubhouse walls are installed.

The 1500 play set series is modular. Because of this some parts will be leftover after the Clubhouse Walls are installed.

Leftover Parts:

2 – 5/4 x 6 x 22” Sandbox Seats, 1 – 2 x 6 x 70” Sandbox Board,

All boards for the Picnic Table. The picnic table parts will be part of the leftover pieces for this set. If your play set is already completed you may choose to remove the picnic table from the right side of the unit and place it on the left side after the clubhouse walls are installed. Placing the picnic table in this position will take up approximately 35% of the useable floor space at the bottom of the play set.

*Clear Silicone Caulk will be needed to fill in any screw holes in the green posts.

#8 X 1-1/4"
WOOD SCREW
QTY: 58



#8 X 1-3/4"
WOOD SCREW
QTY: 118



#8 X 2"
WOOD SCREW
QTY: 28



5/16 x 3-1/2"
LAG SCREW
QTY: 12

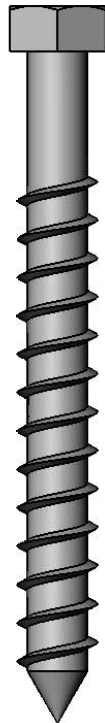

#2 SQUARE
DRIVE TIP
QTY:1

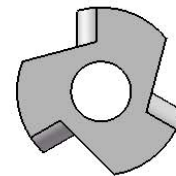

5/16" TEE NUT
QTY: 2

3/8" x 1-1/8"
BLACK PLASTIC
PLUG
QTY: 2

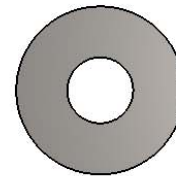
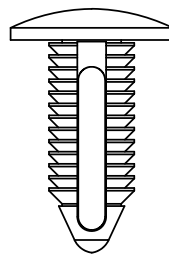

5/16" WASHER
QTY: 16



5/16 X 4-1/2"
HEX BOLT
QTY: 4

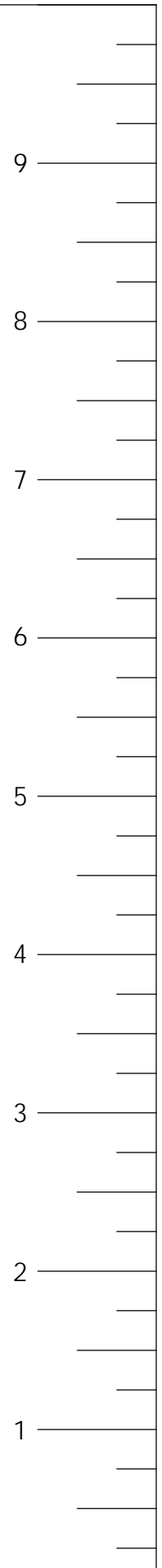

USE THE RULER TO THE RIGHT TO MEASURE YOUR BOLTS AND SCREWS. PICTURE VIEWS SHOWN ABOVE ARE 1:1 SCALE AND CAN BE USED TO MATCH BOLT AND SCREW SIZES.

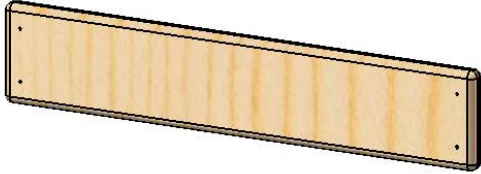
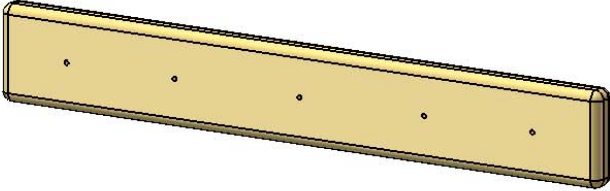
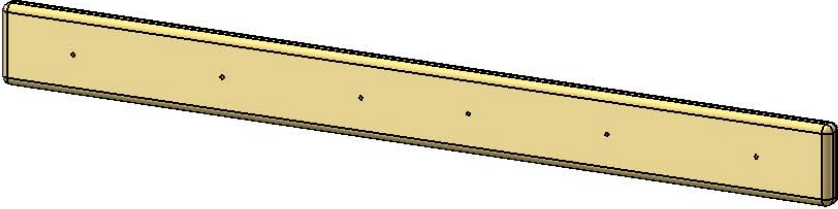
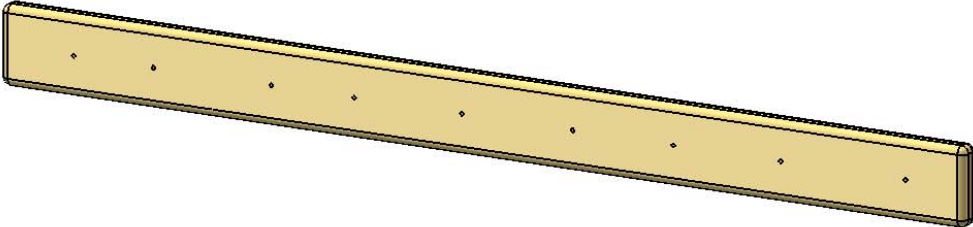
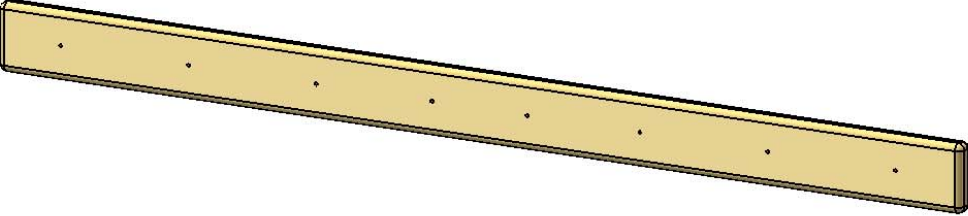
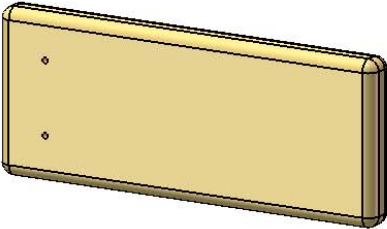
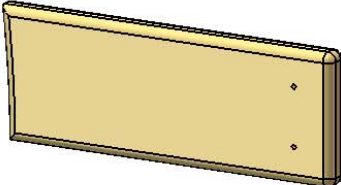
PICTURE	DESCRIPTION	QTY.
	<p>5/4 X 6 X 28-1/4" PANEL SLAT 125-6-2825-PS</p>	<p>7</p>
	<p>1 X 3 X 18" WINDOW TOP BOARD 1-3-1800-WTB</p>	<p>1</p>
	<p>1 X 3 X 29-7/8" OPEN WINDOW OUTSIDE SUPPORT 1-3-2988-OWOS</p>	<p>1</p>
	<p>1 X 3 X 34-3/4" WINDOW BOTTOM BOARD 1-3-3475-WBB</p>	<p>1</p>
	<p>1 X 3 X 40-1/2" PANEL BOARD BRACE 1-3-4050-PBB</p>	<p>2</p>
	<p>1 X 4 X 9" TOP BOARD WINDOW 1-4-0900-TBW</p>	<p>3</p>
	<p>1 X 4 X 9-31/32" OPEN WINDOW TOP BOARD 3 1-4-0998-OWTB3</p>	<p>2</p>

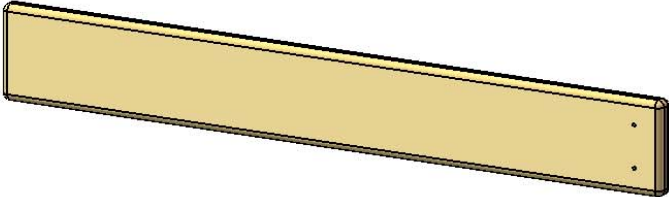
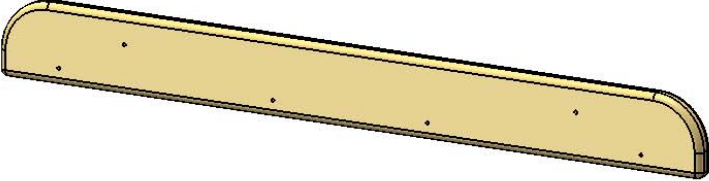
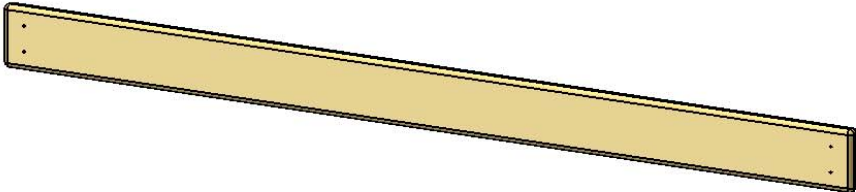
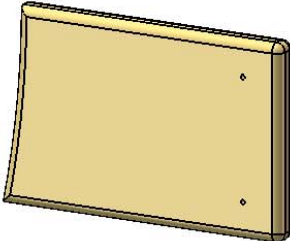
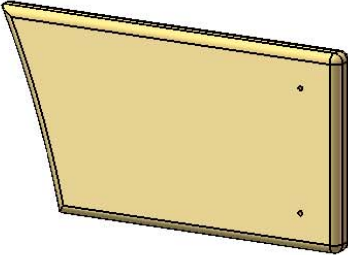
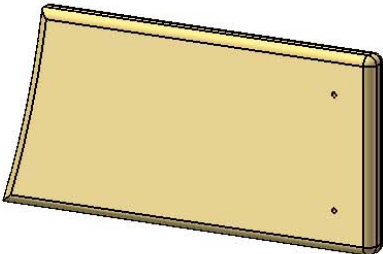
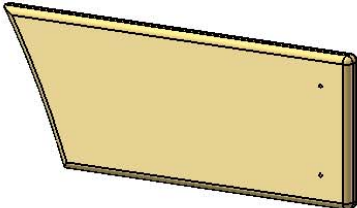
PICTURE	DESCRIPTION	QTY.
	<p>1 X 4 X 27-3/4" BOTTOM WINDOW BOARD</p> <p>1-4-2775-BWB</p>	<p>5</p>
	<p>1 X 4 X 29-1/2" OPEN WINDOW BOARD</p> <p>1-4-2950-OWB</p>	<p>1</p>
	<p>1 X 4 X 51" WALL BOARD</p> <p>1-4-5100-WB</p>	<p>6</p>
	<p>1 X 6 X 8-7/16" TOP BOARD DOOR 2</p> <p>1-6-0843-TBD2</p>	<p>2</p>
	<p>1 X 6 X 10-3/16" TOP BOARD DOOR 1</p> <p>1-6-1020-TBD1</p>	<p>2</p>
	<p>1 X 6 X 11-3/16" OPEN WINDOW TOP BOARD 2</p> <p>1-6-1118-OWTB2</p>	<p>2</p>
	<p>1 X 6 X 13-5/8" OPEN WINDOW TOP BOARD 1</p> <p>1-6-1360-OWTB1</p>	<p>2</p>

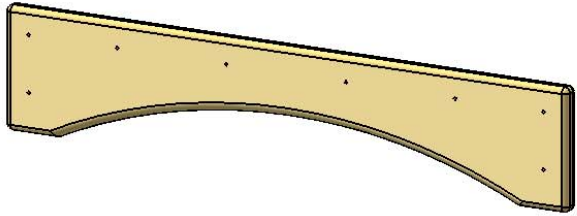
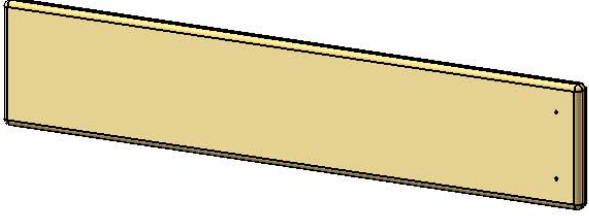
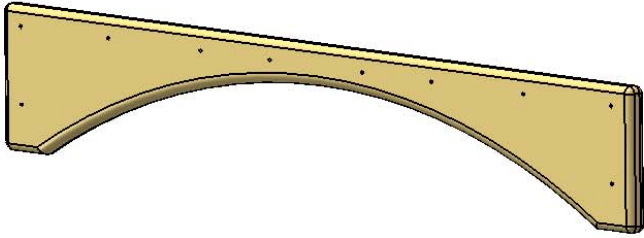
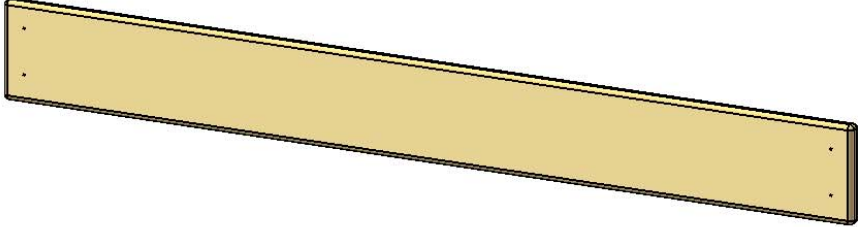
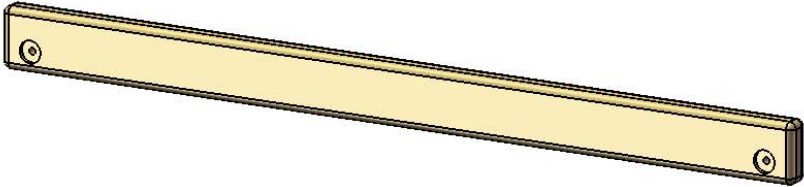
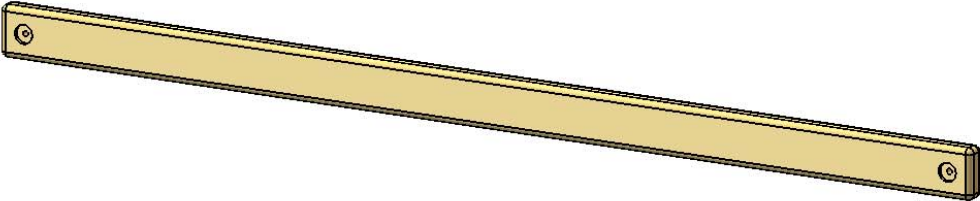
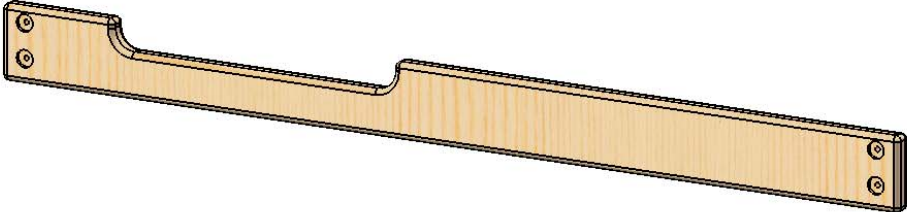
PICTURE	DESCRIPTION	QTY.
	<p>1 X 6 X 27" ARCH TOP BOARD DOOR 1-6-2700-ATBD</p>	<p>1</p>
	<p>1 X 6 X 27-3/4" BOTTOM BOARD OPEN WINDOW 1-6-2775-BBOW</p>	<p>4</p>
	<p>1 X 6 X 34" TOP BOARD WINDOW 1-6-3400-TBW</p>	<p>1</p>
	<p>1 X 6 X 51" WALL BOARD 1-6-5100-WB</p>	<p>11</p>
	<p>2 X 4 X 47-1/2" TOP PANEL BOARD 2-4-4750-TPB</p>	<p>1</p>
	<p>2 X 4 X 70" BOTTOM WALL BOARD 2-4-7000-BWB</p>	<p>2</p>
	<p>2 X 6 X 70" BOTTOM PANEL BOARD DOOR 2-6-7000-BPBD</p>	<p>1</p>

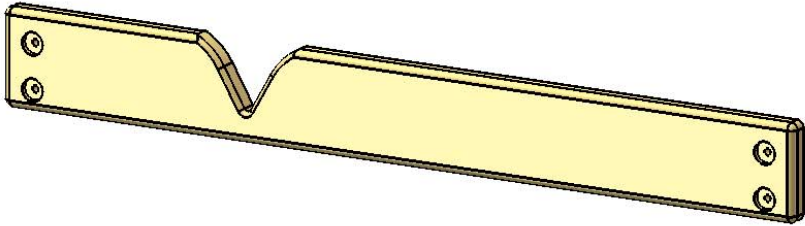
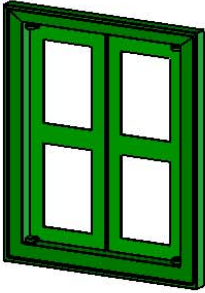
PICTURE	DESCRIPTION	QTY.
	<p>2 X 6 X 47-1/2" BOTTOM BOARD TUBE SLIDE</p> <p>2-6-4750-BBTS</p>	<p>1</p>
	<p>WINDOW</p> <p>07-0013</p>	<p>1</p>
<p>(NOT SHOWN)</p>	<p>1518 HARDWARE</p> <p>11-0054</p>	<p>1</p>

STEP 1: REMOVING THE PICNIC TABLE

- 1: REMOVE THE PICNIC TABLE TO ATTACH THE RIGHT SIDE CLUBHOUSE WALL.
- 2: REMOVE THE SCREWS THAT CONNECT THE PICNIC TABLE SUPPORTS TO THE CORNER POSTS.
- 3: SET THE PICNIC TABLE ASSEMBLY AND SCREWS ASIDE IN CASE YOU WISH TO REINSTALL THE PICNIC TABLE ON THE OTHER SIDE OF THE FORT LATER.
- 4: PLACE CLEAR SILICONE IN THE SCREW HOLES IN THE CORNER POSTS.

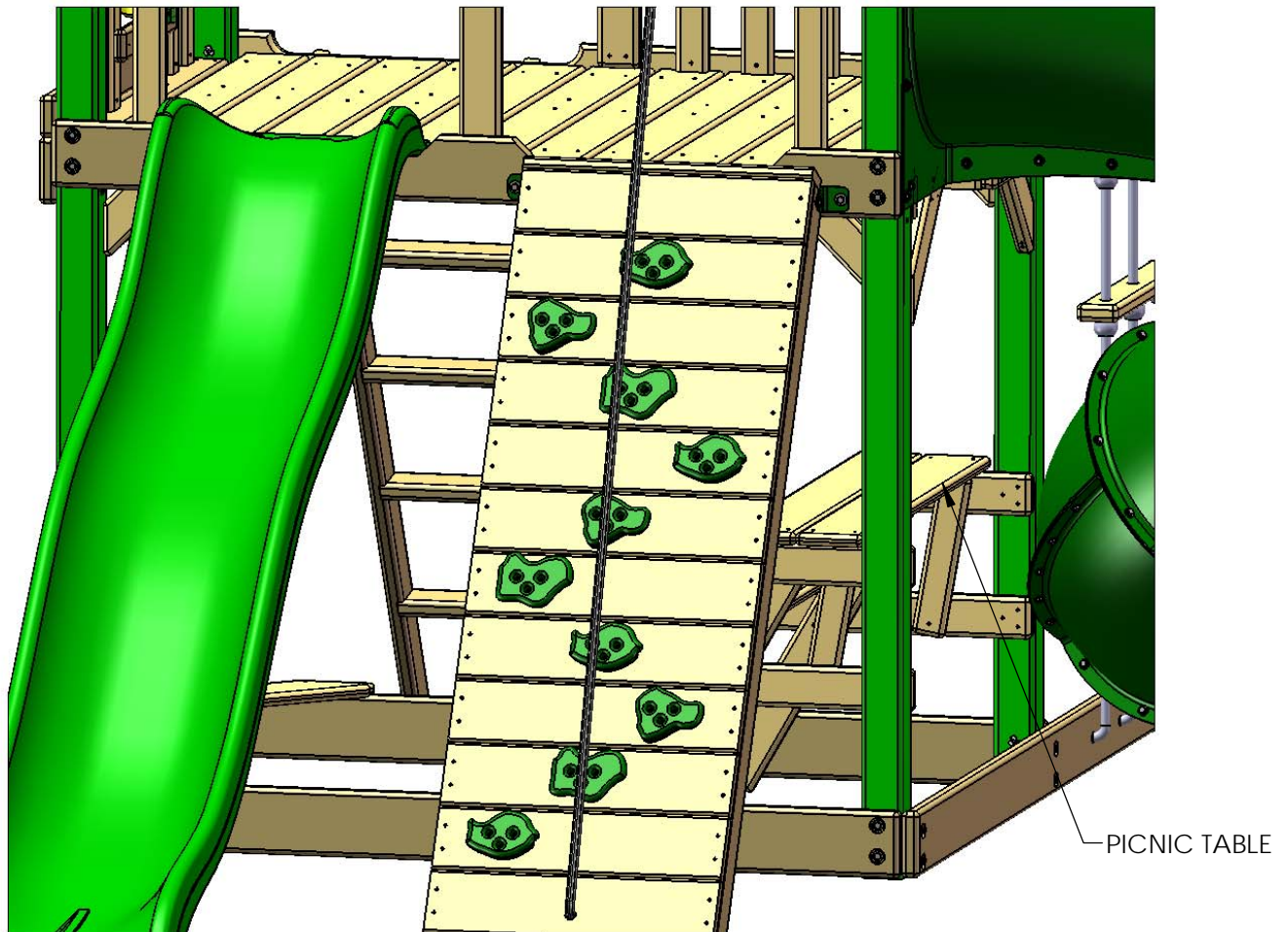

STEP 2: REMOVING SANDBOX SEATS

1: REMOVE THE TWO SANDBOX SEAT BOARDS TO ATTACH THE WALL BOARDS.

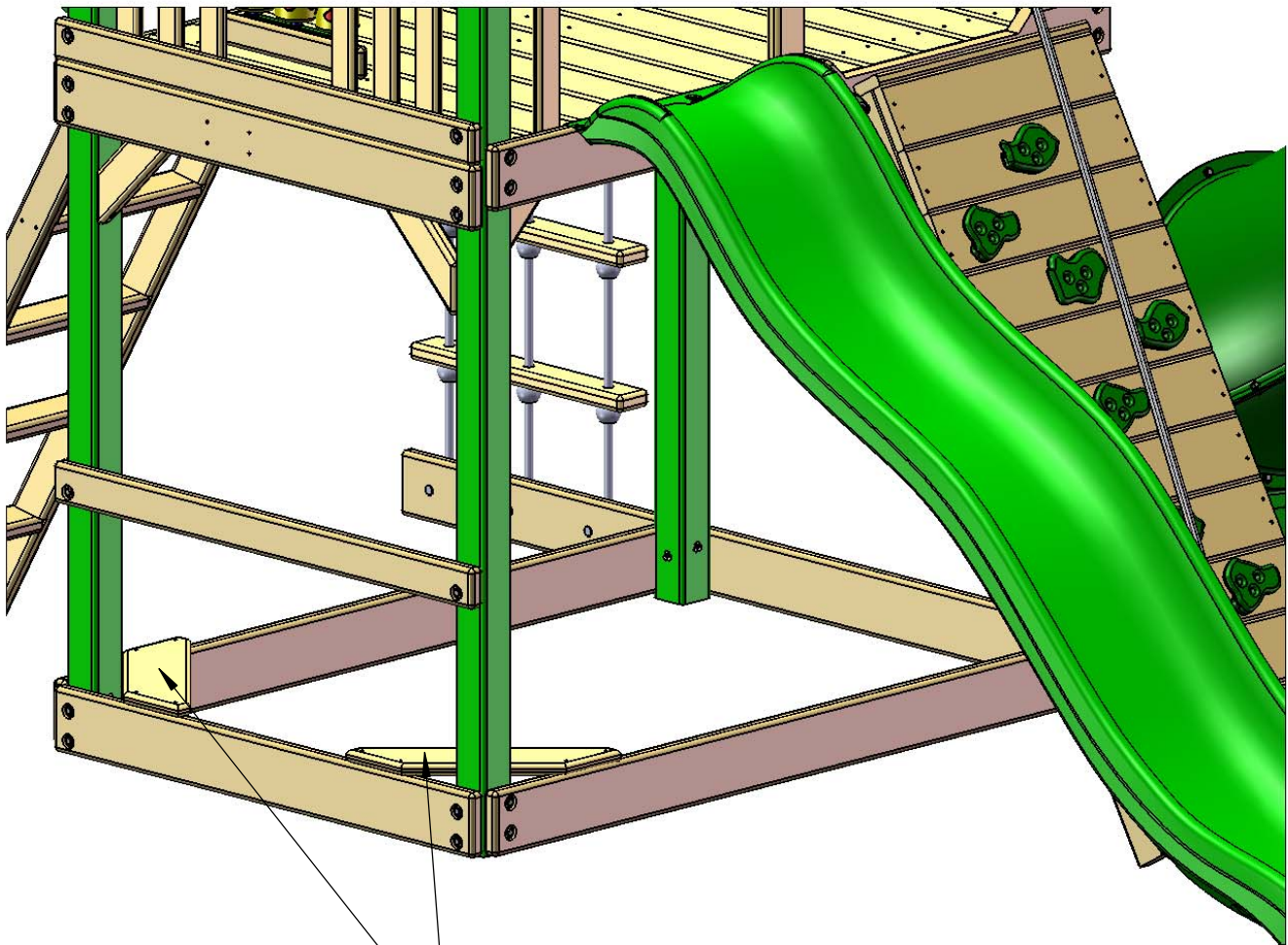

SANDBOX SEAT

STEP 3: REMOVING THE ANGLE SUPPORTS

- 1: REMOVE THE BACK AND SIDE ANGLE SUPPORTS UNDER THE DECK.
- 2: KEEP THE TWO ANGLE SUPPORTS AT THE FRONT.
- 3: AFTER YOU INSTALL ALL THE CLUBHOUSE WALLS PUT THE ANGLE SUPPORTS BACK ON. IT IS A GOOD IDEA TO LEAVE SCREWS IN THE ANGLE SUPPORTS AND TO NUMBER THEM AND THEIR LOCATION FOR LATER.
- 4: PLACE CLEAR SILICONE IN THE SCREW HOLES IN THE CORNER POSTS FOR THE ANGLE SUPPORTS AT THE LEFT AND RIGHT SIDES OF THE SET.

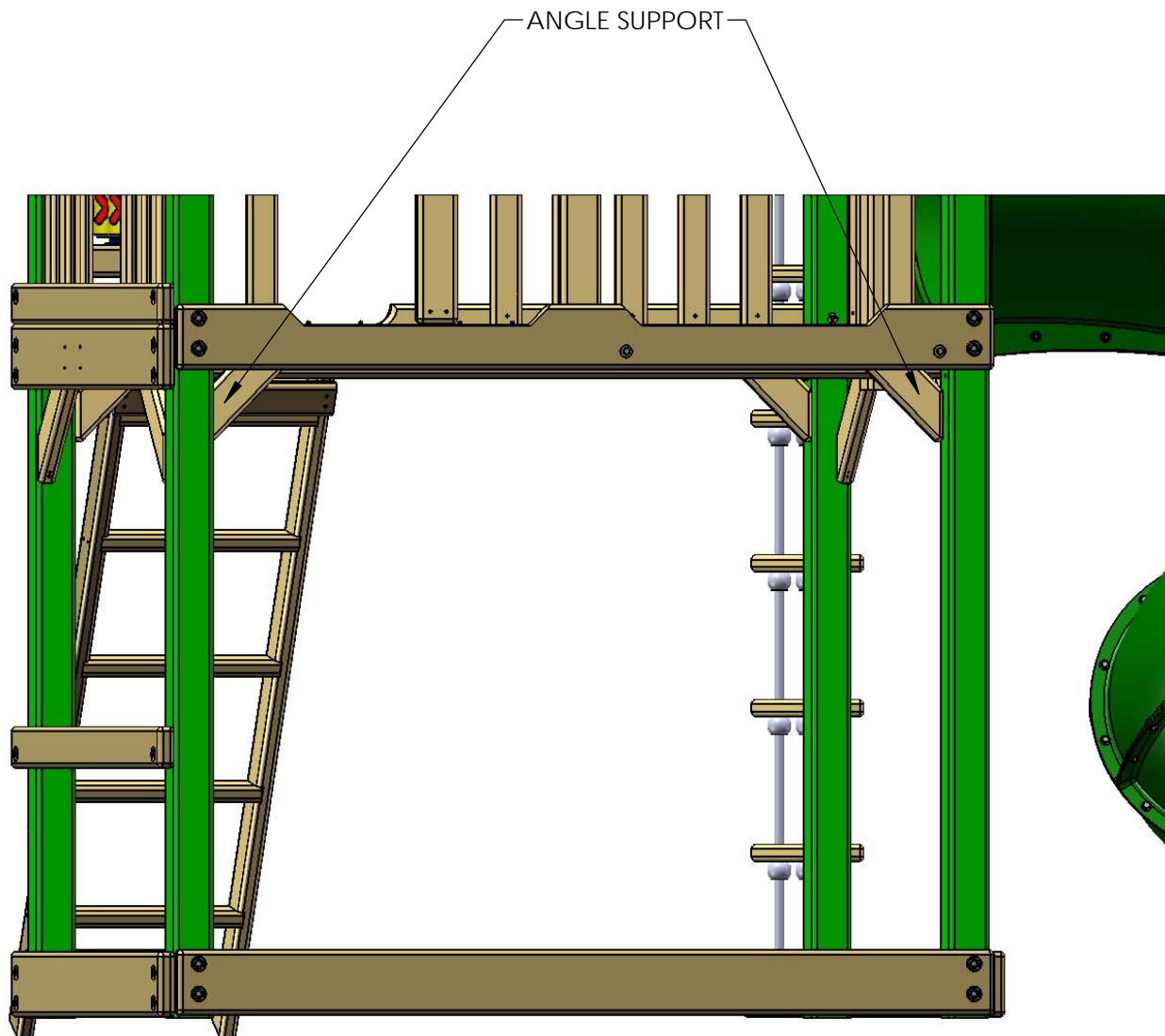

STEP 4: TUBE SLIDE BOARD

1: REMOVE THE END PANEL BOARD.

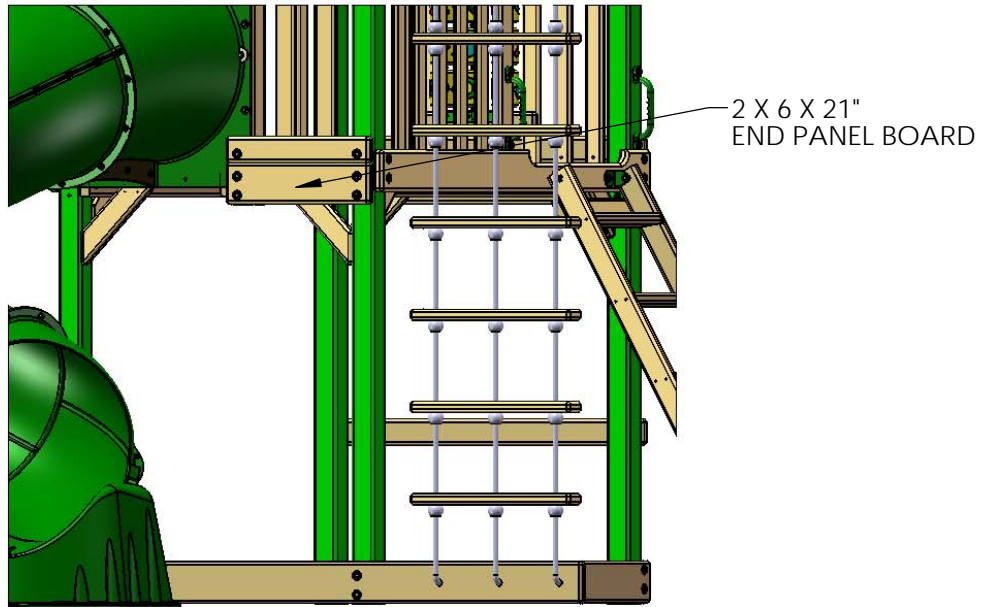

2: PLACE THE BOTTOM BOARD TUBE SLIDE ON THE PLACE END PANEL BOARD . USE 5/16 X 4-1/2" HEX BOLTS, 5/16 X 3-1/2" LAG SCREWS AND FOUR 5/16" WASHERS TO ATTACH IT TO THE CORNER POSTS.

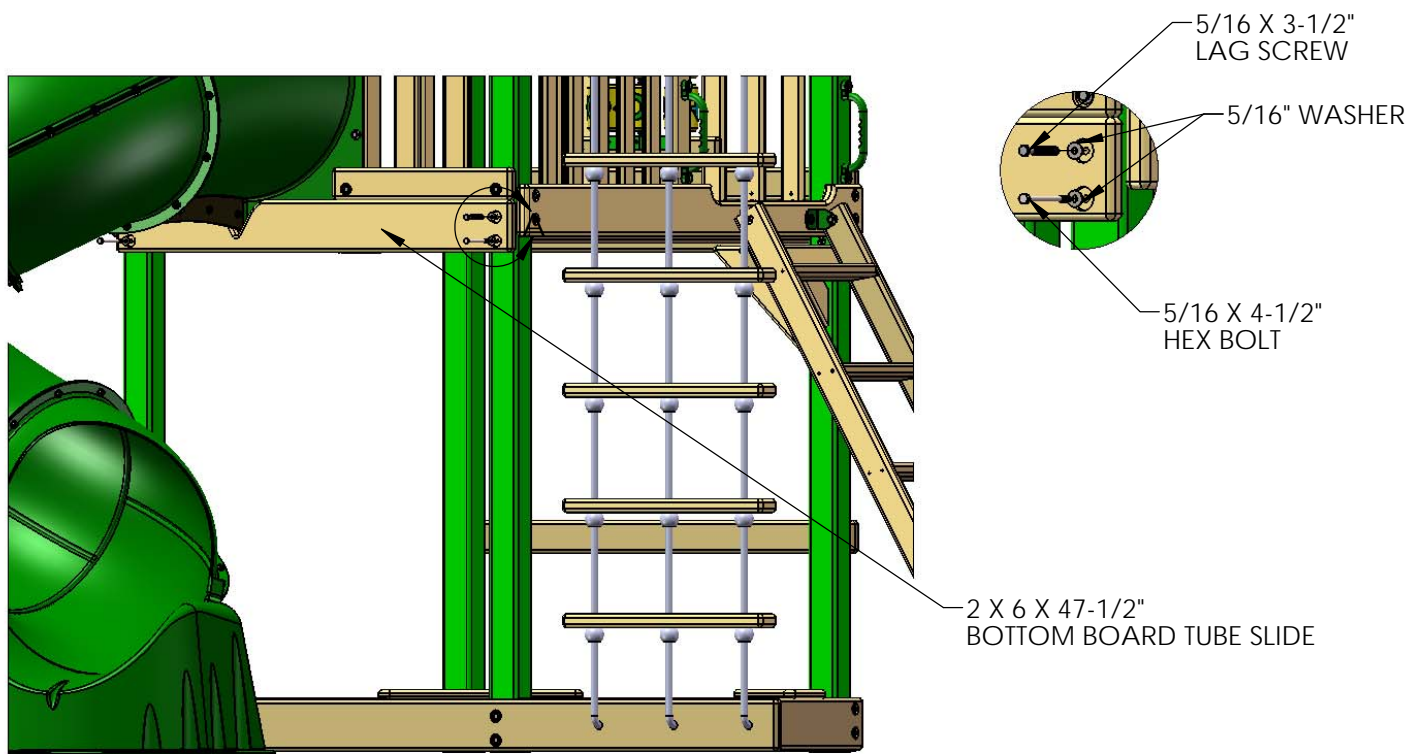

STEP 5: SAFETY BOARD

1: REMOVE THE SAFETY BOARD.

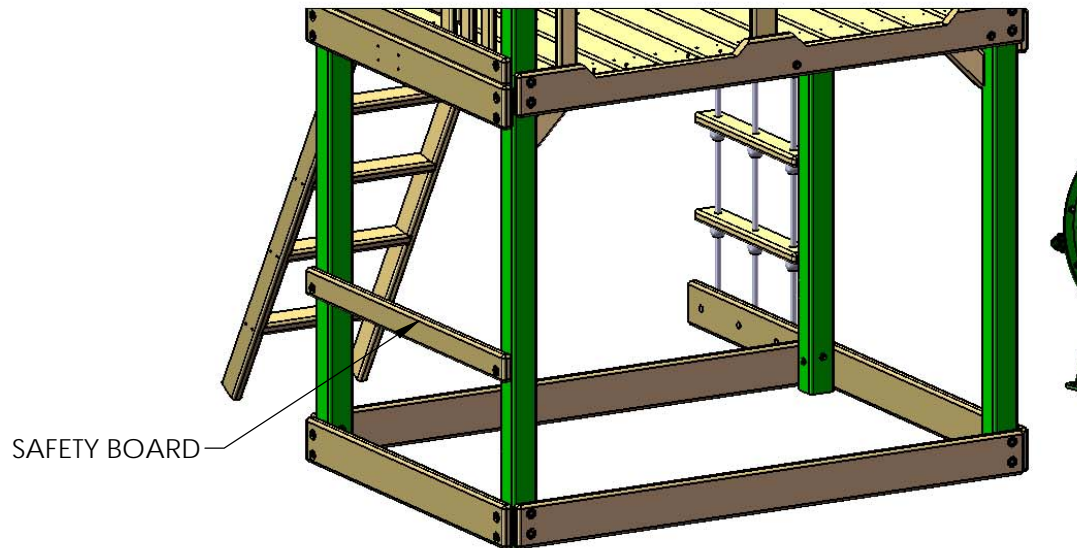

2: PLACE THE SAFETY BOARD YOU JUST REMOVED FLUSH WITH 2 X 6 BOTTOM BOARD. USE TWO 5/16 X 3-1/2" LAG SCREWS AND TWO 5/16" WASHERS TO ATTACH IT TO CORNER POSTS.

3: DAB SOME SILICONE ON THE PLASTIC PLUGS AND PLACE THE PLASTIC PLUGS IN THE HOLES LEFT FROM REMOVING THE SAFETY BOARD IN THE CORNER POSTS.

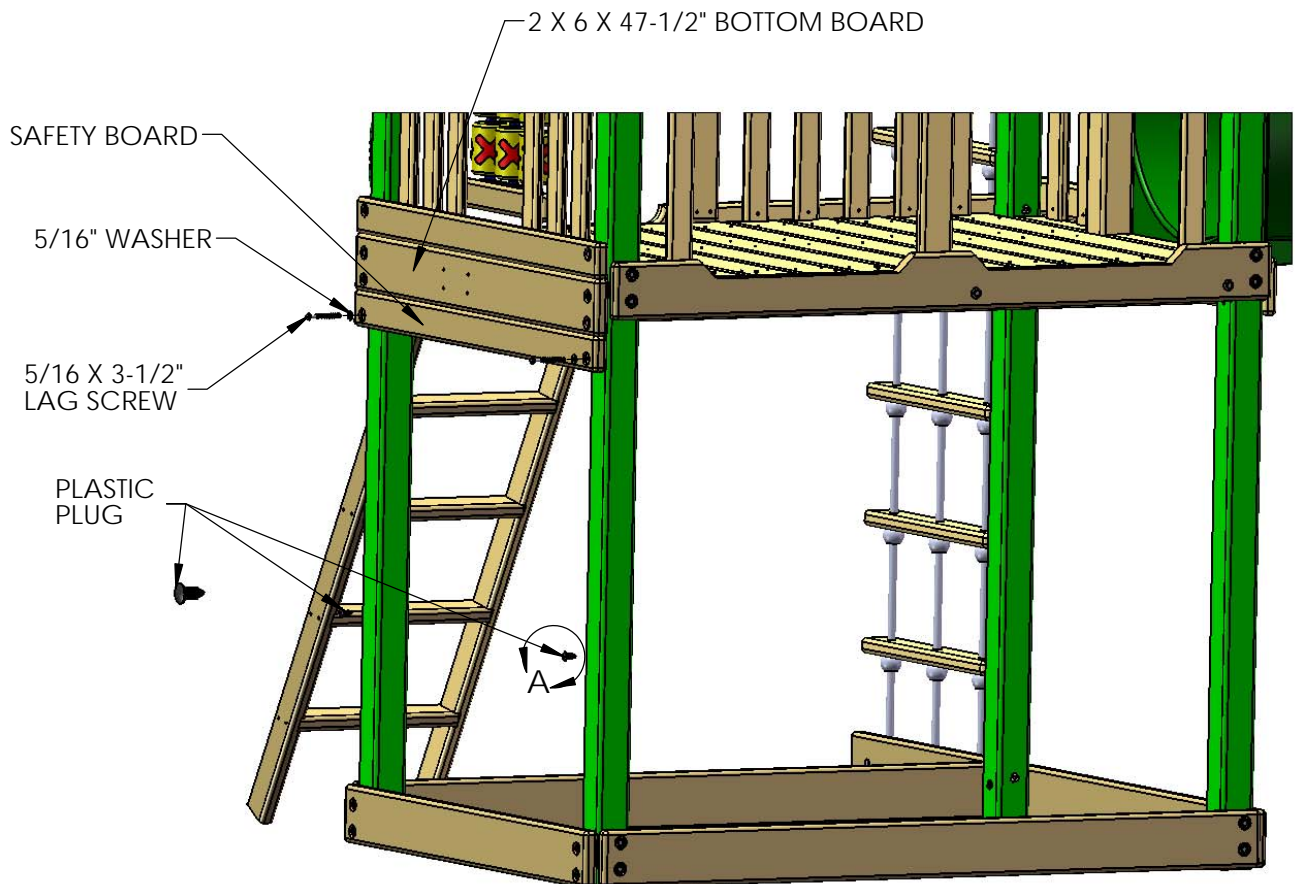

STEP 6: BACK SANDBOX BOARD AND BOTTOM BOARD

1: REMOVE THE SANDBOX BOARD ON THE BACK OF THE FORT .



2: REPLACE SANDBOX BOARD YOU JUST REMOVED WITH 2 X 6 X 70" BOTTOM PANEL BOARD DOOR WITH CUT NOTCH UP. USE 5/16 X 4-1/2" HEX BOLTS ON THE TOP HOLES, 5/16 X 3-1/2" LAG SCREWS ON BOTTOM HOLES AND 5/16" WASHERS TO ATTACH IT TO THE POSTS.

3: PLACE THE 2 X 4 X 70" BOTTOM WALL BOARD FLUSH WITH 2 X 6 BOTTOM BOARD. USE TWO 5/16 X 3-1/2" LAG SCREWS WITH 5/16" WASHERS TO ATTACH IT TO THE POSTS.

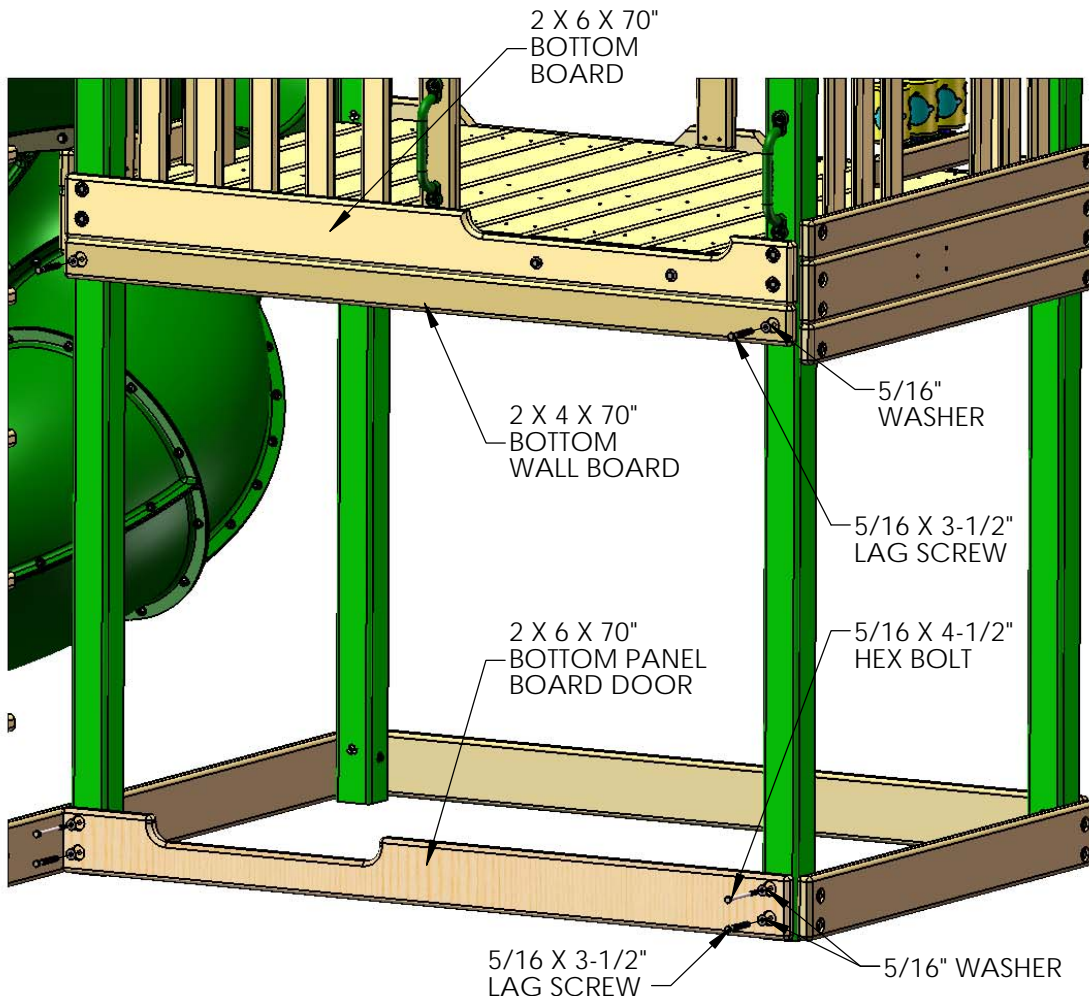

STEP 7: TOP PANEL BOARD

1: PLACE THE 2 X 4 X 47-1/2" TOP PANEL BOARD ON THE TUBE SLIDE SIDE OF THE FORT. MAKE THE TOP PANEL BOARD FLUSH WITH 2 X 6 X 47-1/2" BOTTOM BOARD TUBE SLIDE.

2: USE 5/16 X 3-1/2" LAG SCREWS AND 5/16" WASHERS TO ATTACH THE TOP PANEL BOARD TO THE CORNER POSTS.

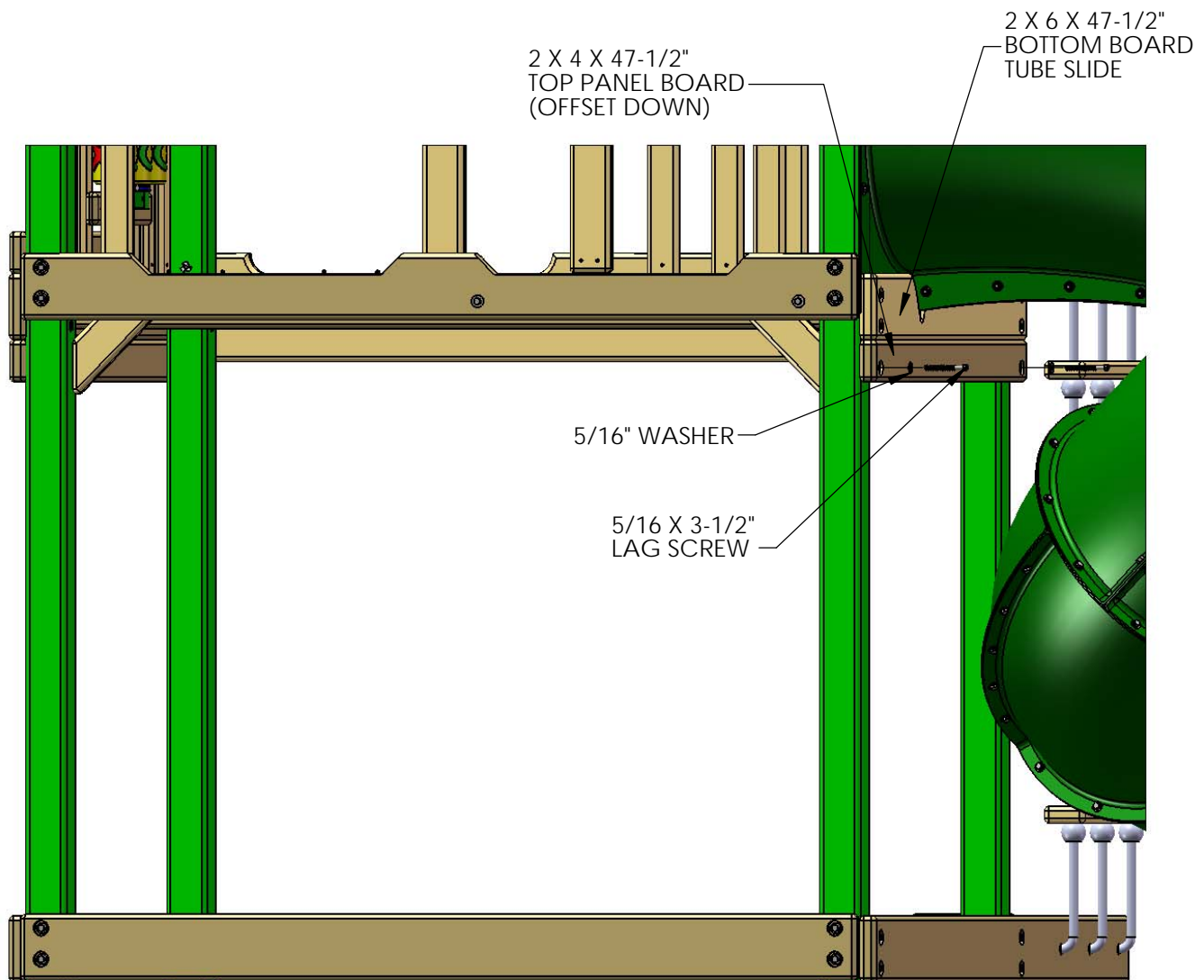

STEP 8: WALL BOARD SWING BEAM SIDE

1: FIND SIX 1 X 6 X 51" WALL BOARDS AND TWO 1 X 4 X 51" WALL BOARDS WITH PRE-DRILLED HOLES.

2: PLACE WALL BOARDS ON THE SWING BEAM SIDE OF THE FORT AGAINST THE TOP SAFETY BOARD AND SANDBOX BOARD AS SHOWN BELOW. THE BOTTOM OF THE WALL BOARDS SHOULD BE 1-1/2" ABOVE THE BOTTOM OF THE SANDBOX BOARD.

3: USE #8 X 1-3/4" WOOD SCREWS LEAVING 1/4" SPACES BETWEEN THE WALL BOARDS TO ATTACH THEM TO THE SAFETY BOARD AND SANDBOX BOARD.

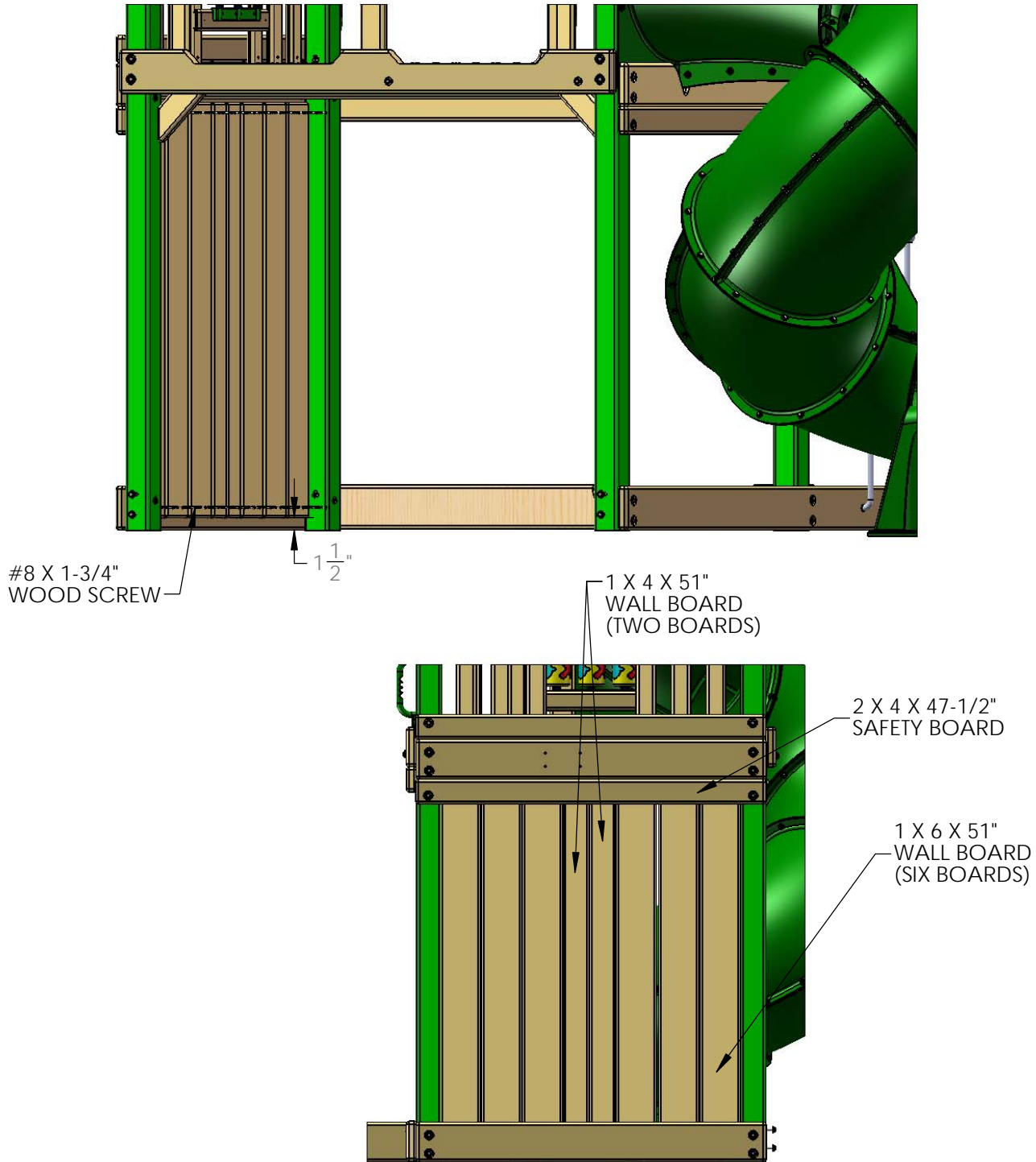

STEP 9: ATTACHING PANEL BOARD BRACE

1: PLACE THE 1 X 3 X 40-1/2" PANEL BOARD BRACE AT THE CENTER OF THE WALL BOARDS YOU ATTACHED TO THE SWING BEAM SIDE. FASTEN IT TO THE WALL BOARDS WITH # 8 X 1-1/4" WOOD SCREWS.

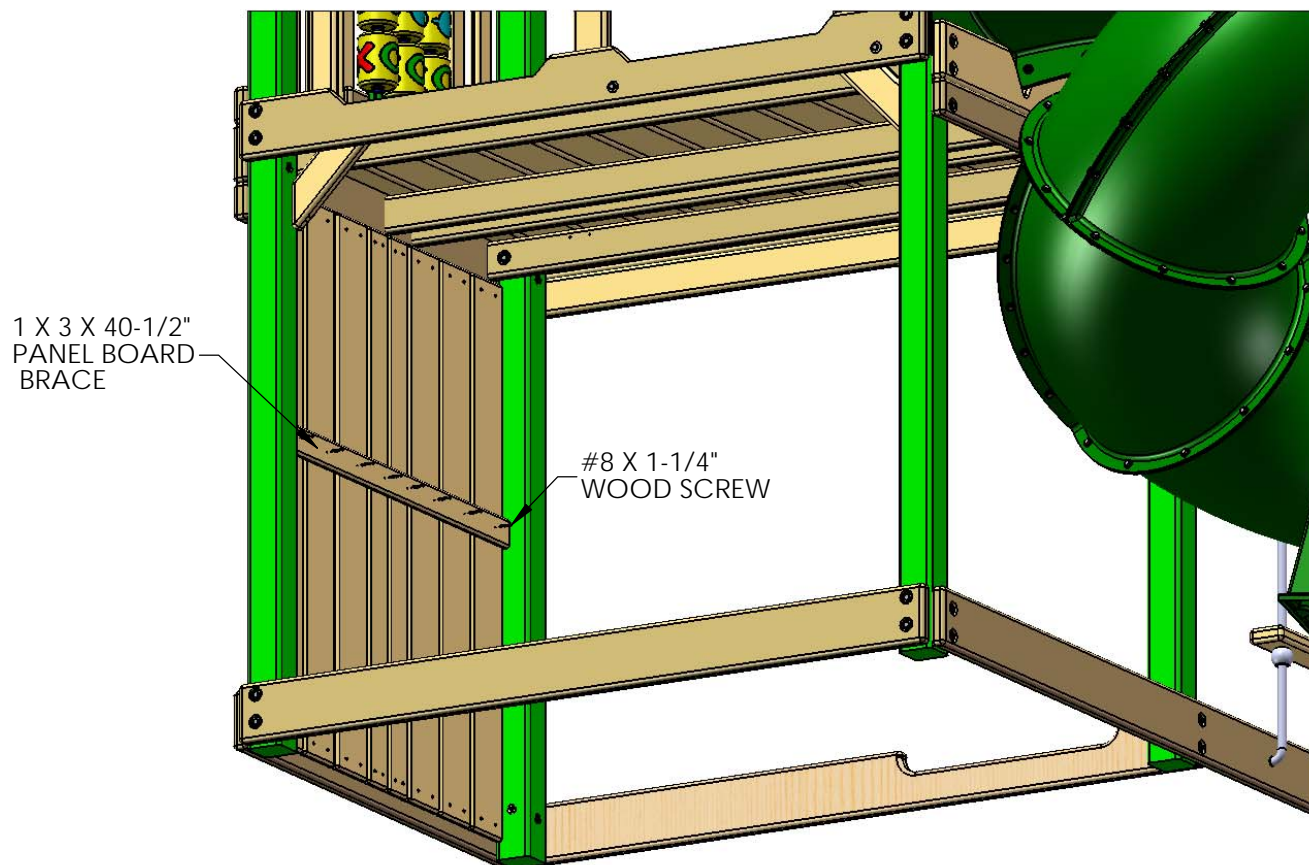

STEP 10: REAR WALL BOARDS

1: PLACE WALL BOARDS ON THE REAR SIDE OF THE FORT AGAINST THE BOTTOM PANEL BOARD DOOR AND BOTTOM PANEL BOARD AS SHOWN BELOW. THE BOTTOM OF THE WALL PANEL BOARDS SHOULD BE 1-1/2" ABOVE THE BOTTOM OF THE BOTTOM PANEL BOARD DOOR. THE OPENING DIMENSIONS FOR ATTACHING THE WINDOWS IN NEXT STEP ARE SHOWN BELOW.

2: USE #8 X 1-3/4" WOOD SCREWS LEAVING 1/4" SPACES BETWEEN THE WALL BOARDS TO ATTACH THEM TO THE BOTTOM PANEL BOARD DOOR AND BOTTOM PANEL BOARD.

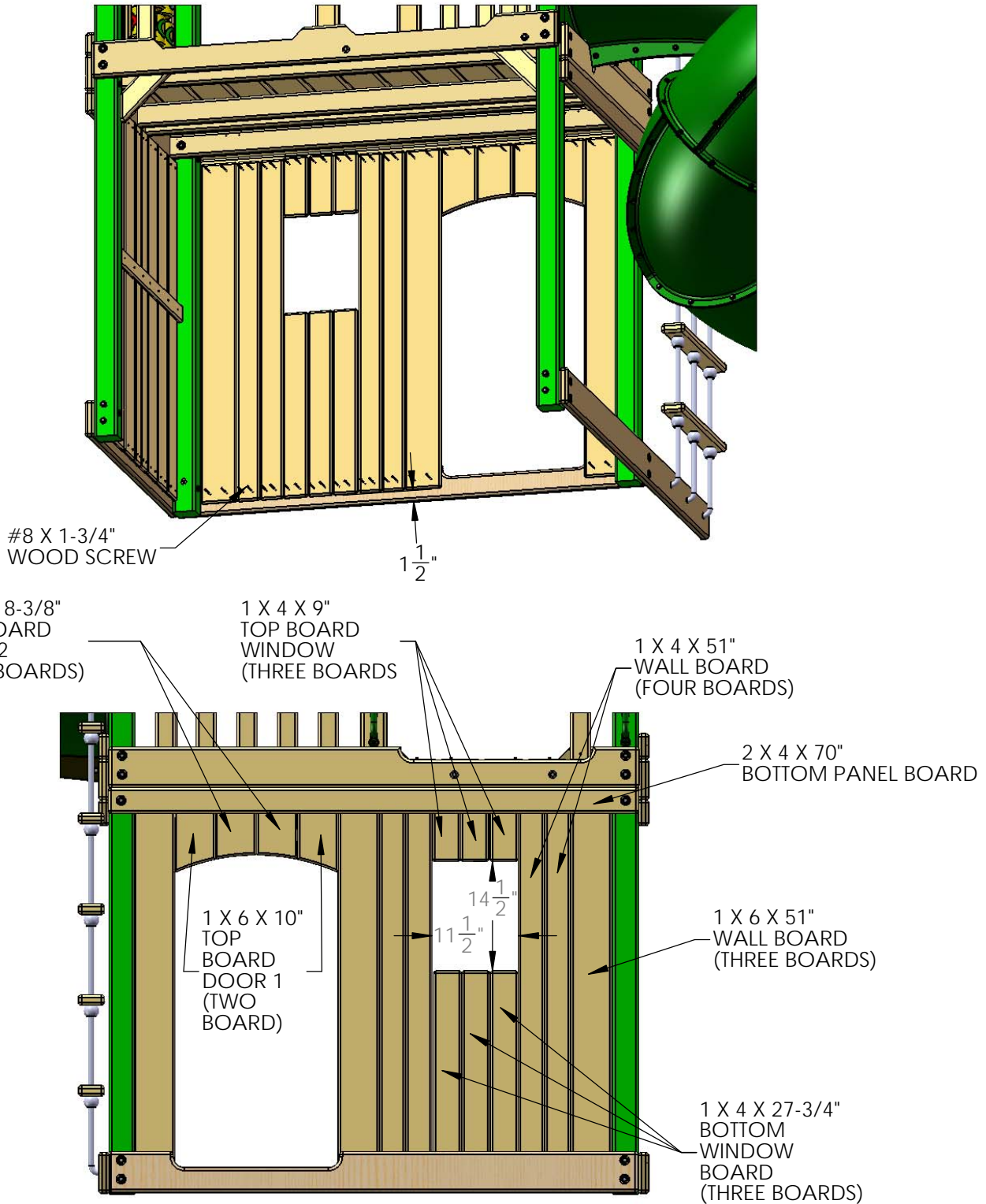

STEP 11: INSTALL WINDOW

1: FIND THE PLASTIC WINDOW. PLACE WINDOW AT THE REAR OF THE FORT IN THE OPENING. THE 1" WIDE SECTION OF THE WINDOW FRAME SHOULD BE AT THE TOP. ATTACH THE WINDOW WITH FOUR 1-1/4" WOOD SCREWS.

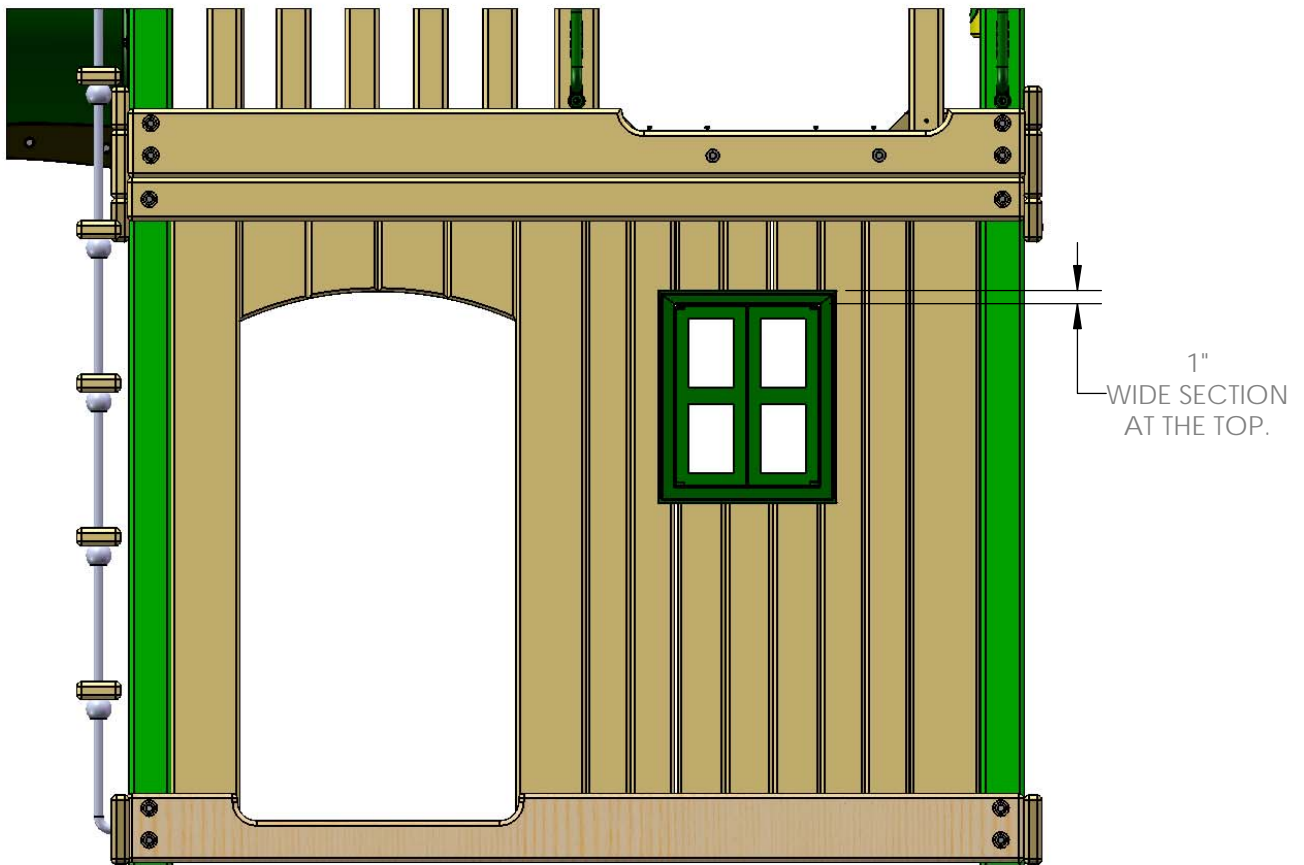

STEP 12: WINDOW BOARD AND DOOR BOARD

1: PLACE THE 1 X 3 X 34-3/4" BOTTOM BOARD WINDOW FLUSH WITH BOTTOM OF THE WINDOW. FASTEN WITH # 8 X 1-1/4" WOOD SCREWS.

2: PLACE THE 1 X 3 X 18" TOP BOARD WINDOW FLUSH WITH TOP OF THE WINDOW. FASTEN WITH # 8 X 1-1/4" WOOD SCREWS.

3: PLACE THE 1 X 6 X 27" ARCH TOP BOARD DOOR FLUSH WITH THE BOTTOM OF THE TOP DOOR BOARD . FASTEN WITH # 8 X 1-1/4" WOOD SCREWS.

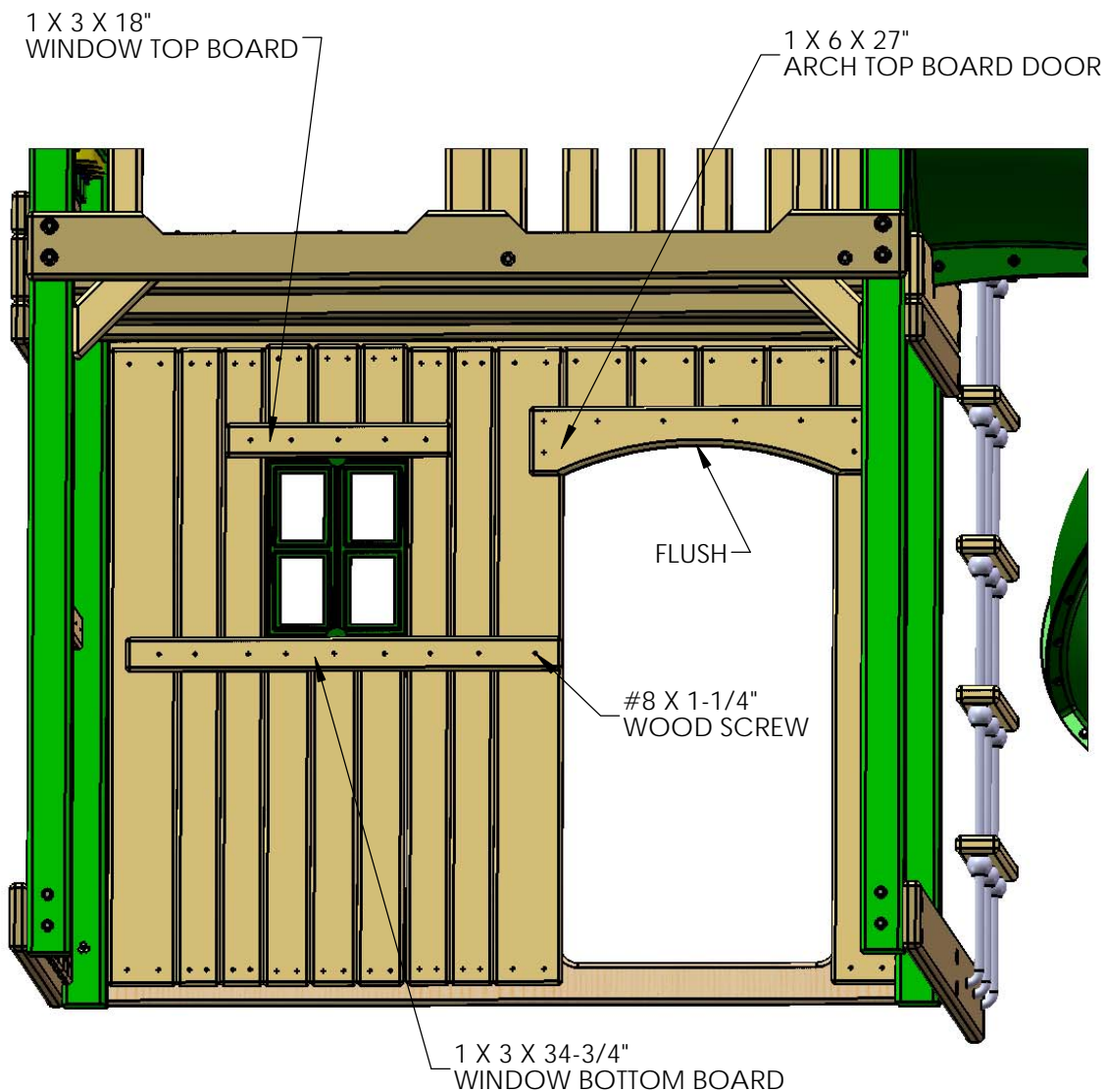

STEP 13: RIGHT SIDE WALL BOARDS

1: PLACE WALL BOARDS ON THE RIGHT SIDE OF THE FORT AGAINST THE TOP WALL PANEL BOARD AND ROPE LADDER RUNNER AS SHOWN BELOW. THE BOTTOM OF THE WALL BOARDS SHOULD BE 1-1/2" ABOVE THE BOTTOM OF THE ROPE LADDER RUNNER. FASTEN WITH # 8 X 1-3/4" WOOD SCREWS LEAVING A 1/4" SPACE BETWEEN THE BOARDS.

NOTE: SWING BEAM WALL AND TUBE SLIDE REMOVED FOR CLARITY.

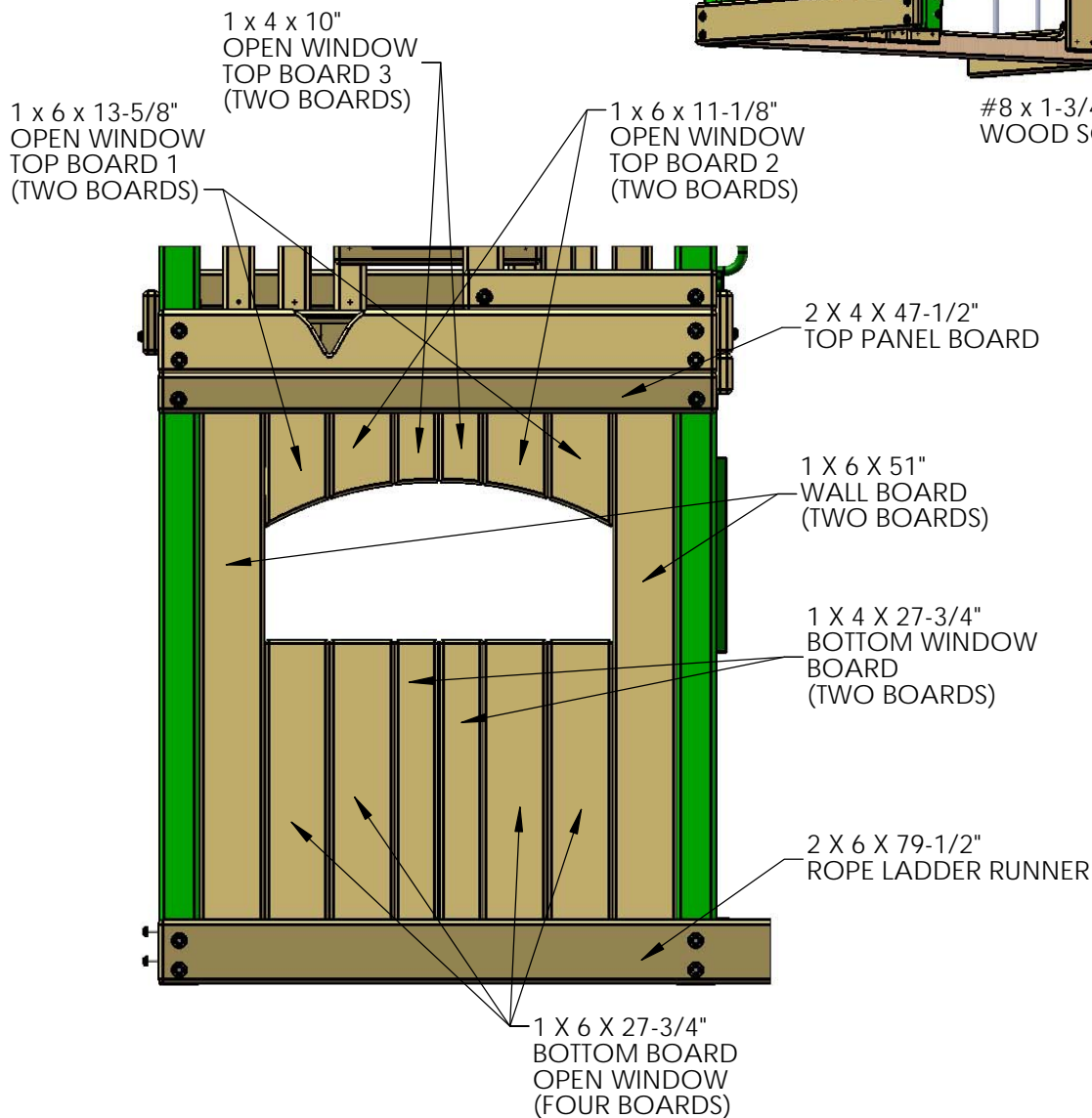
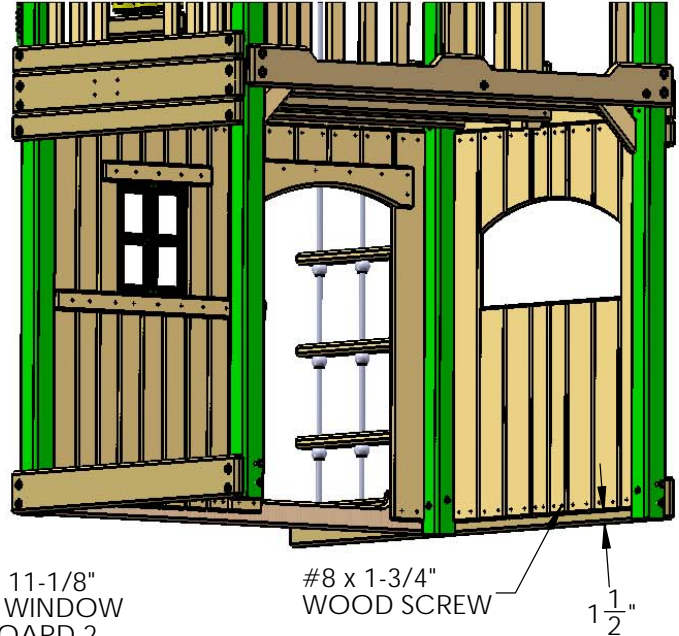

STEP 14: PANEL BOARD BRACE AND BOARD WINDOW

1: PLACE THE 1 X 3 X 40-1/2" PANEL BOARD BRACE FLUSH WITH BOTTOM BOARD OPEN WINDOWS. FASTEN WITH # 8 X 1-1/4" WOOD SCREWS.

2: PLACE THE 1 X 6 X 34" TOP BOARD WINDOW FLUSH WITH OPEN WINDOW TOP BOARDS. FASTEN WITH # 8 X 1-1/4" WOOD SCREWS.

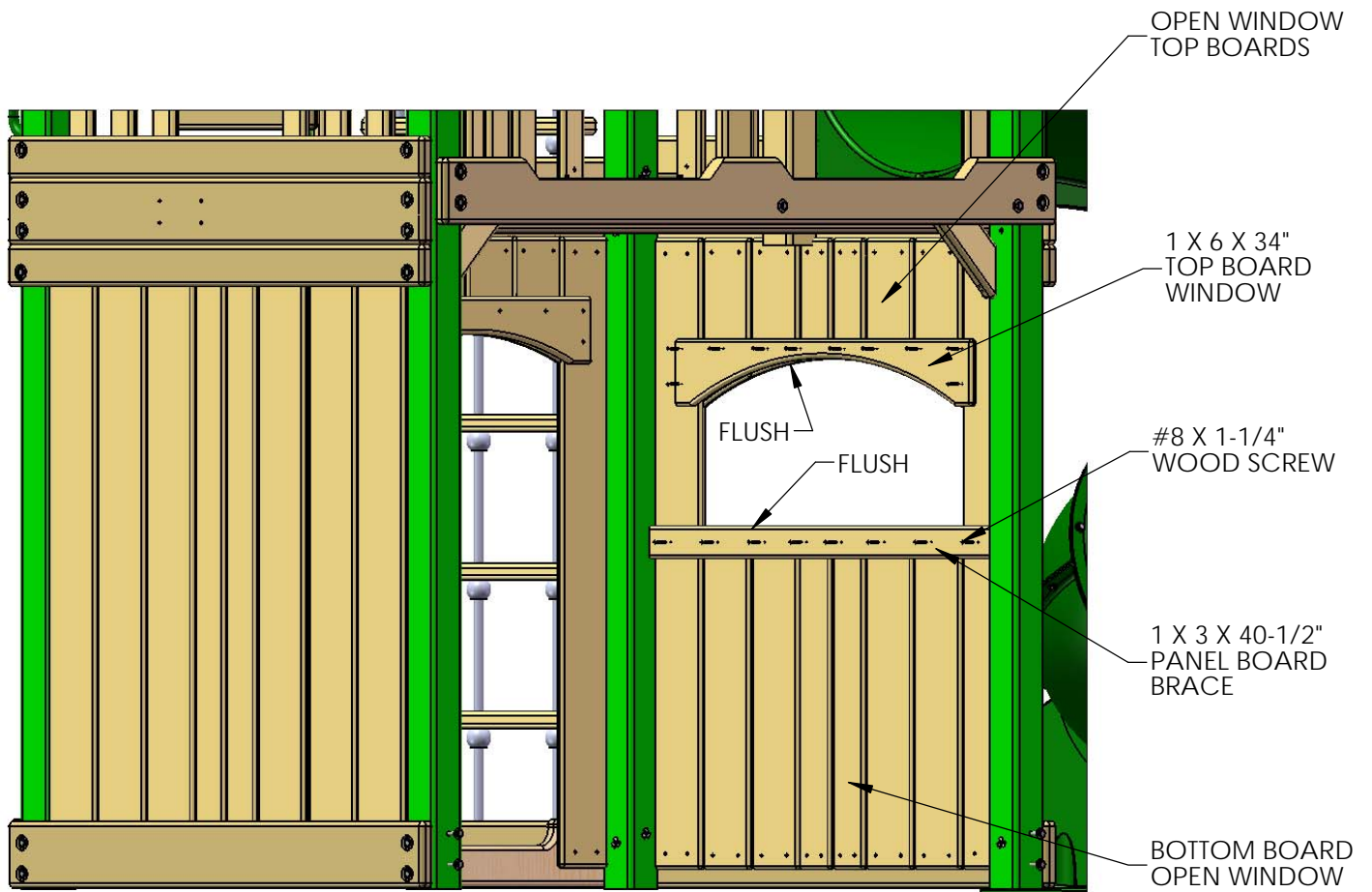

STEP 15: OPEN WINDOW OUTSIDE SUPPORT

1: PLACE THE 1 X 3 X 29-7/8" OPEN WINDOW OUTSIDE SUPPORT ON THE OUTSIDE OF THE RIGHT WALL BOARDS. FLUSH THE SUPPORT WITH THE TOP OF THE BOTTOM BOARD OPEN WINDOWS. FASTEN WITH # 8 X 1-1/4" WOOD SCREWS.

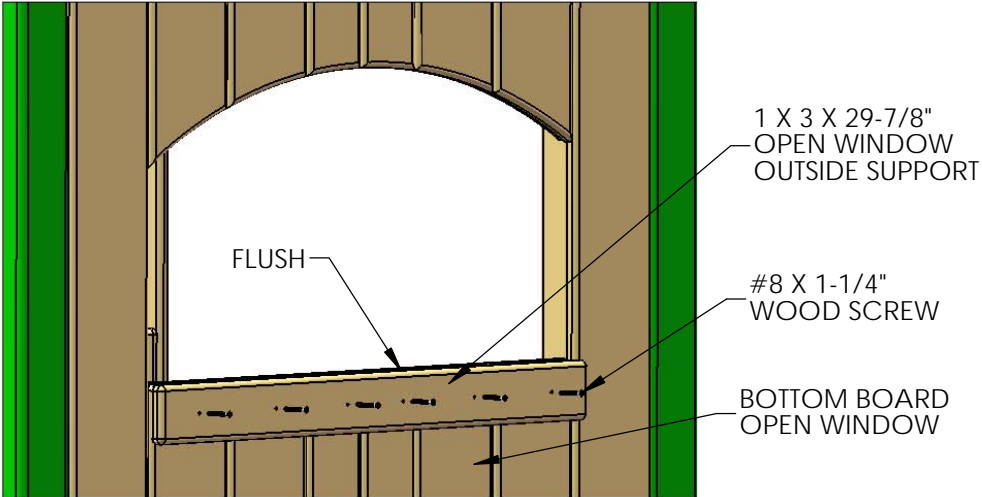

DETAIL A
SCALE 2 : 17

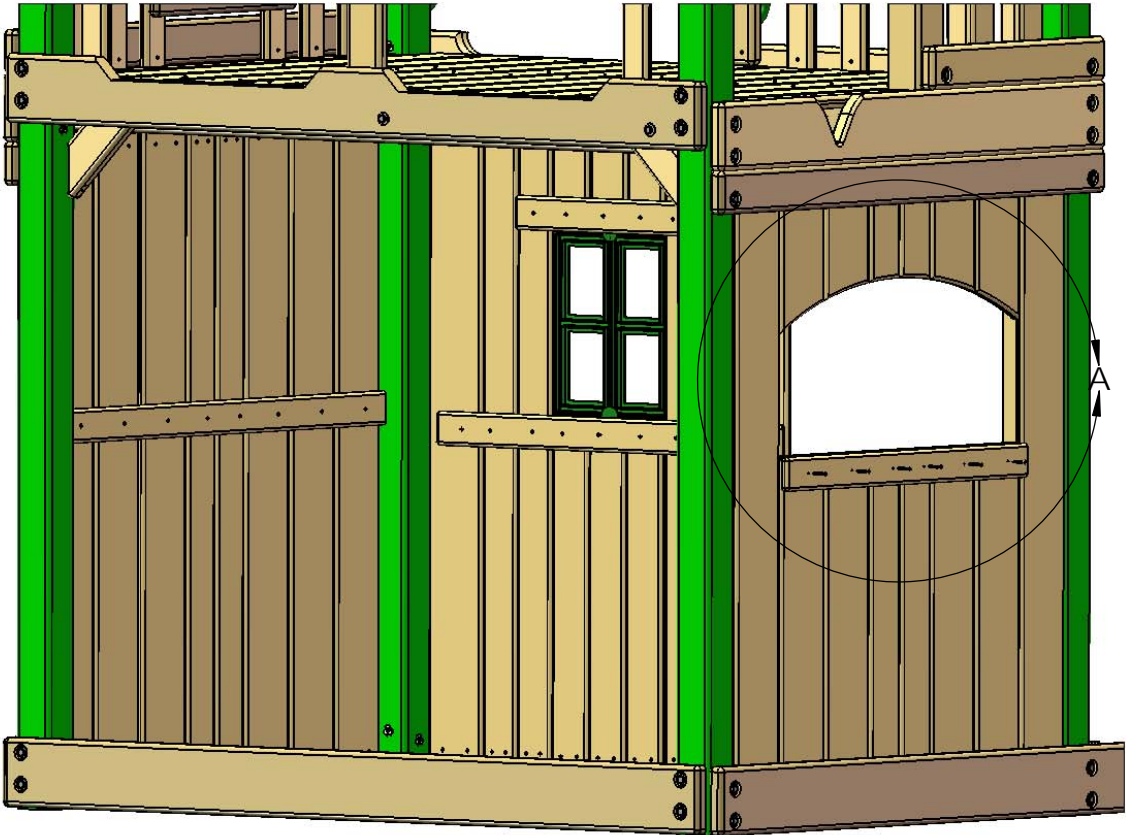

STEP 16: OPEN WINDOW BOARD

1: PLACE THE 1 X 4 X 29-1/2" OPEN WINDOW BOARD ON TOP FLUSH TO INSIDE OF THE PANEL BOARD BRACE . FASTEN WITH # 8 X 1-3/4" WOOD SCREWS.

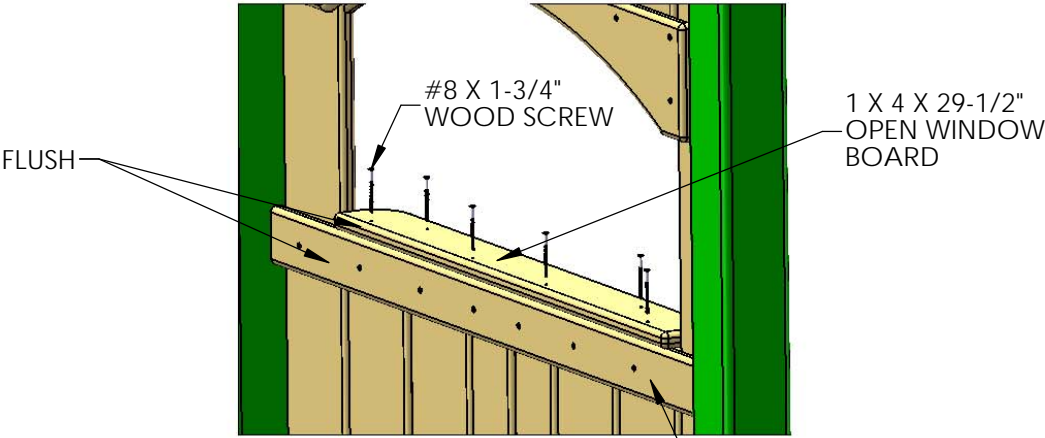

FLUSH

#8 X 1-3/4"
WOOD SCREW

1 X 4 X 29-1/2"
OPEN WINDOW
BOARD

PANEL BOARD BRACE

DETAIL A
SCALE 2 : 17

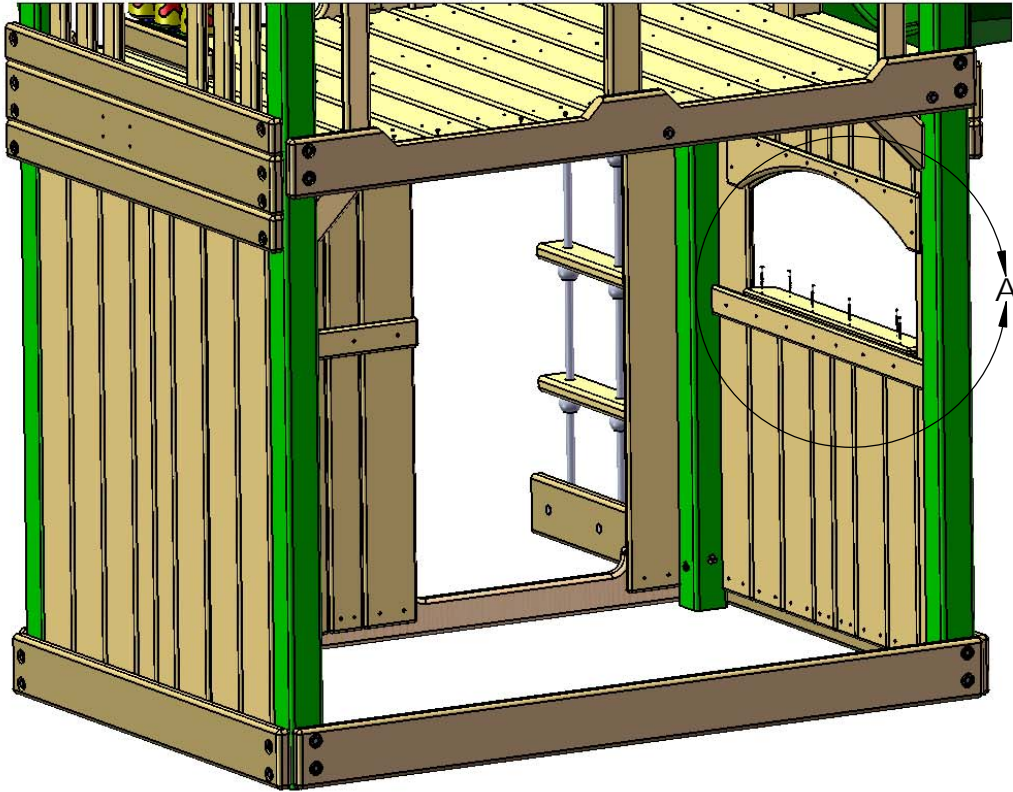

STEP 17: BOTTOM WALL BOARD

1: PLACE THE 2 X 4 X 70" BOTTOM WALL BOARD AT THE FRONT OF THE FORT. THE TOP OF THE 2 X 4 X 70" BOTTOM WALL BOARD SHOULD BE 30-3/8" FROM THE BOTTOM OF THE 2 X 6 X 70" SANDBOX BOARD.

2: FASTEN THE 2 X 4 X 70" BOTTOM WALL BOARD TO THE CORNER POSTS WITH 5/16" X 3-1/2" LAG SCREWS AND 5/16" WASHERS.

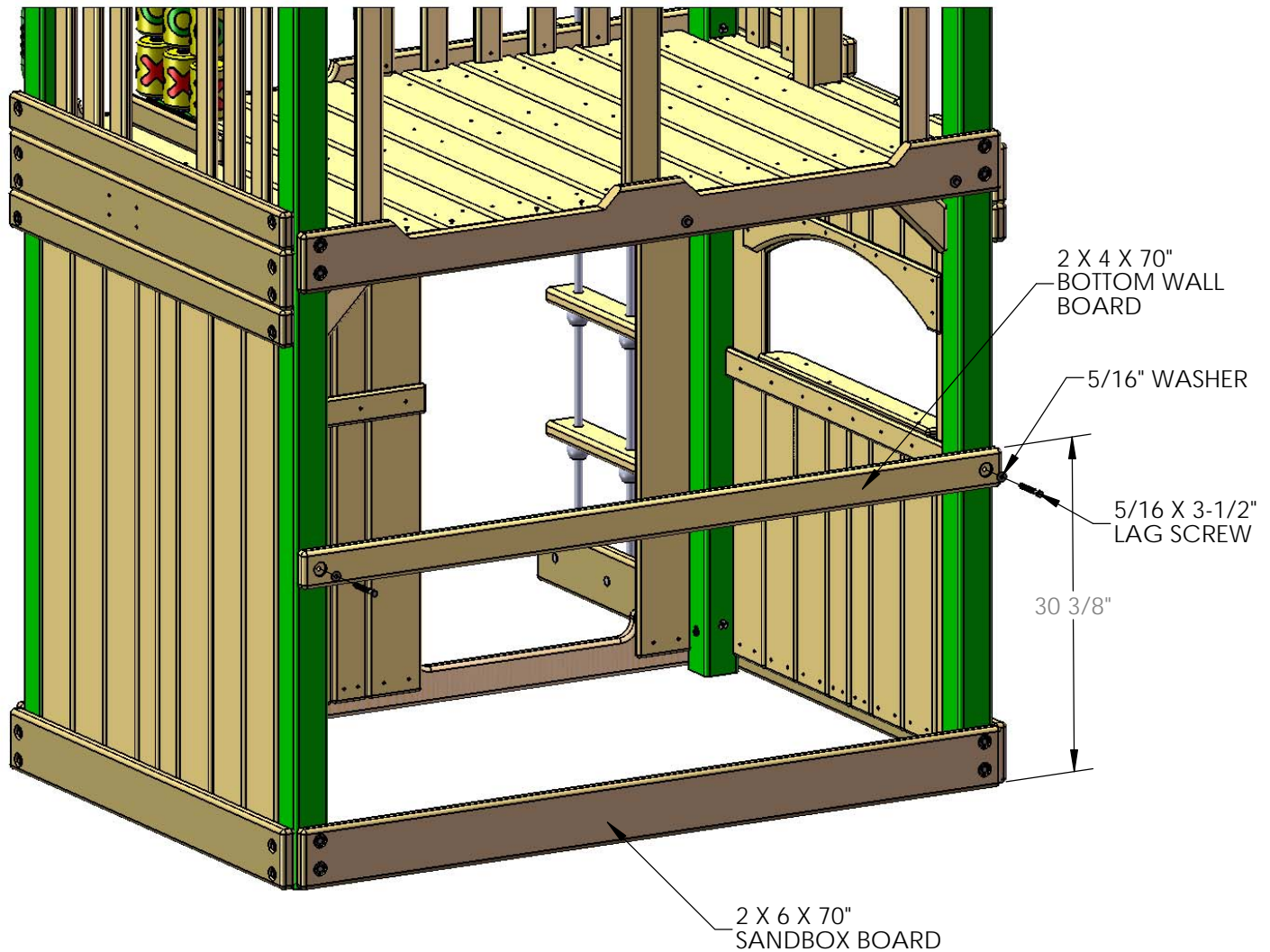

STEP 18: PANEL SLATS

- 1: FIND SEVEN 5/4 X 6 X 28-1/4" PANEL SLATS.
- 2: INSTALL THE PANEL SLATS AT EQUAL LENGTHS. SEE DETAIL BELOW FOR MEASUREMENTS.
- 3: ATTACH THE PANEL SLATS TO THE FORT WITH 2" WOOD SCREWS IN THE PRE-DRILLED HOLES.

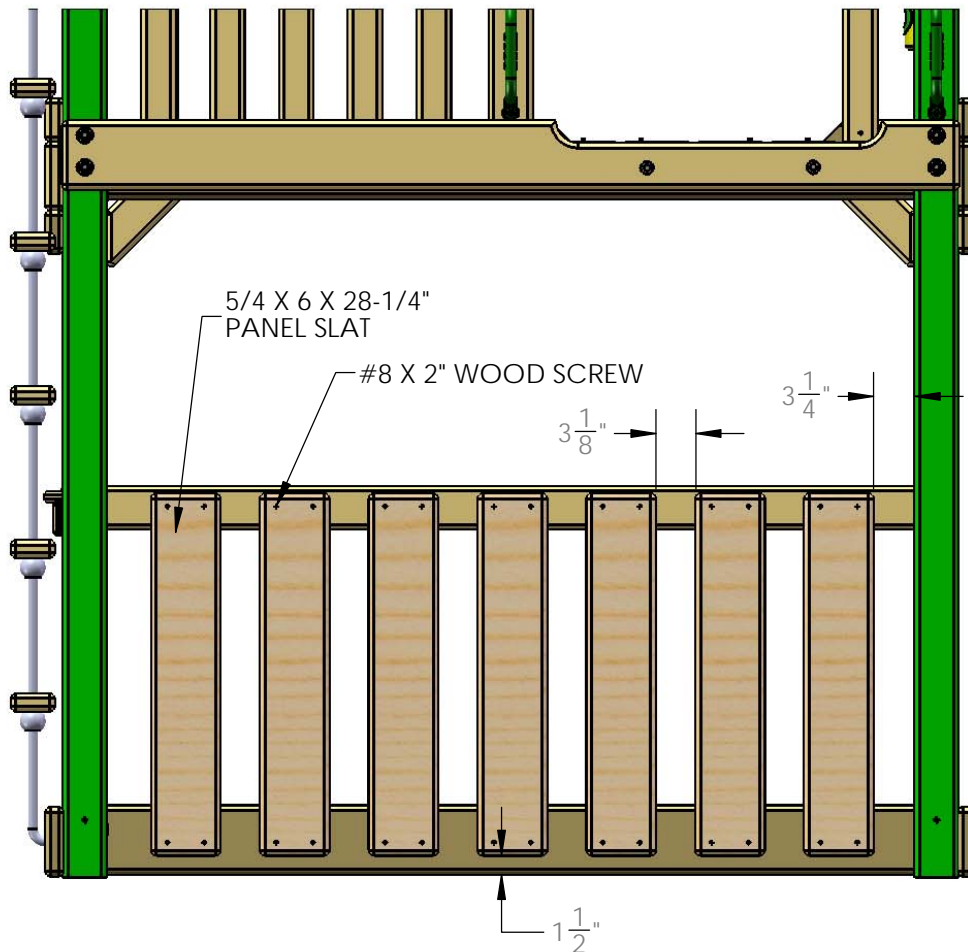

STEP 19: ANGLE SUPPORTS

1: REPLACE THE ANGLE SUPPORTS YOU REMOVED IN STEP 3.

2: REFER TO STEP 6B IN THE MAIN MANUAL IF YOU DID NOT MARK YOUR ANGLE SUPPORTS IN STEP 3 OF THIS MANUAL.

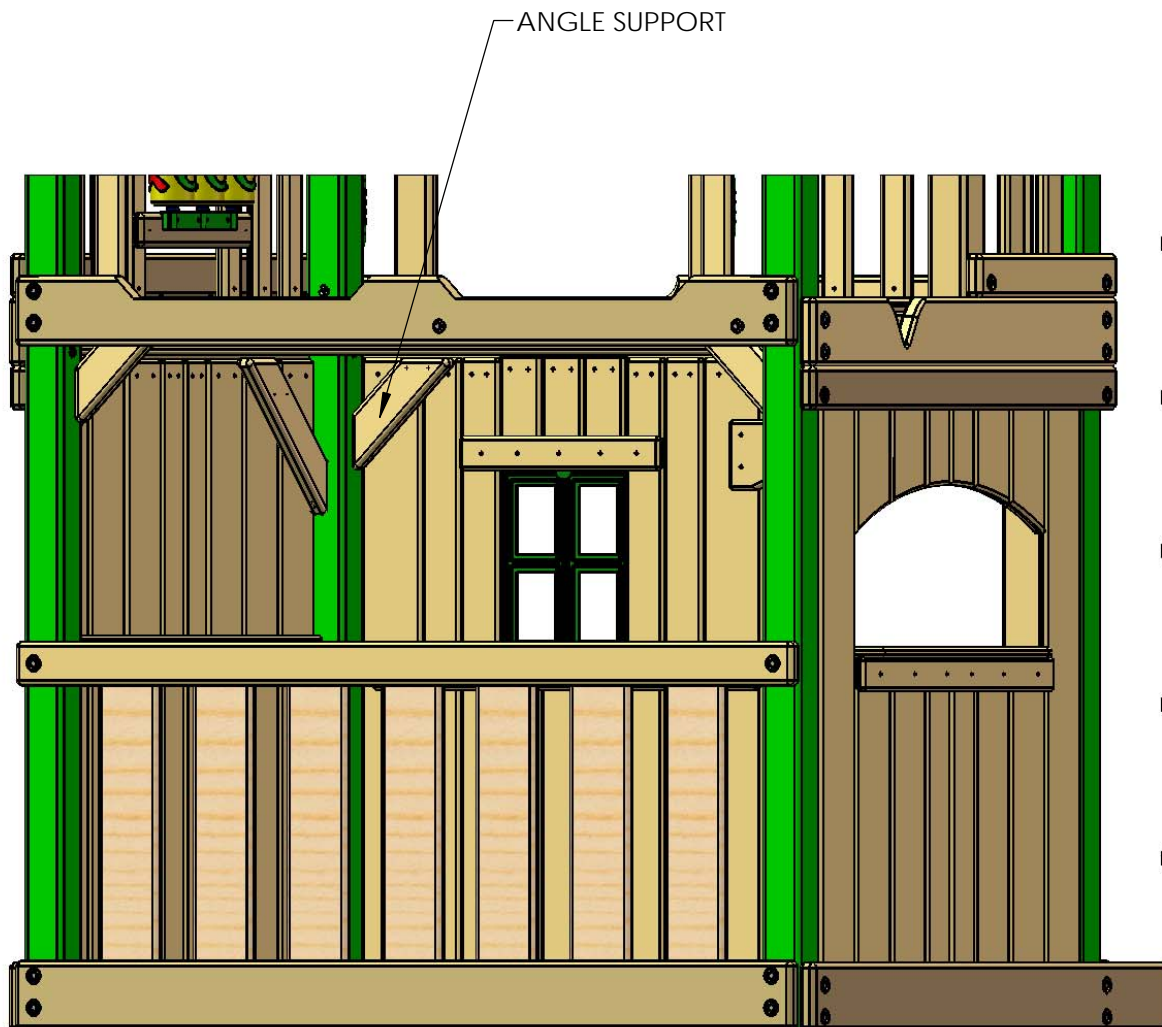

STEP 20: PICNIC TABLE

1: YOU MAY INSTALL THE PICNIC TABLE ON THE INSIDE-LEFT CORNER POSTS.

2: RE-ATTACH THE PICNIC TABLE SUPPORTS TO THE LEFT CORNER POSTS WITH THE SCREWS REMOVED IN **STEP 1**. IF THIS IS THE FIRST TIME INSTALLING THE PICNIC TABLE THEN REFER TO THE MAIN PART OF THE MANUAL **STEP 34** TARP ROOF OR **STEP 35** SIDE TO SIDE ROOF OR **STEP 44** FRONT TO BACK ROOF FOR DIMENSIONS. INSTALL WITH 3" WOOD SCREWS ON THE LEFT SIDE OF THE UNIT AS SHOWN BELOW.

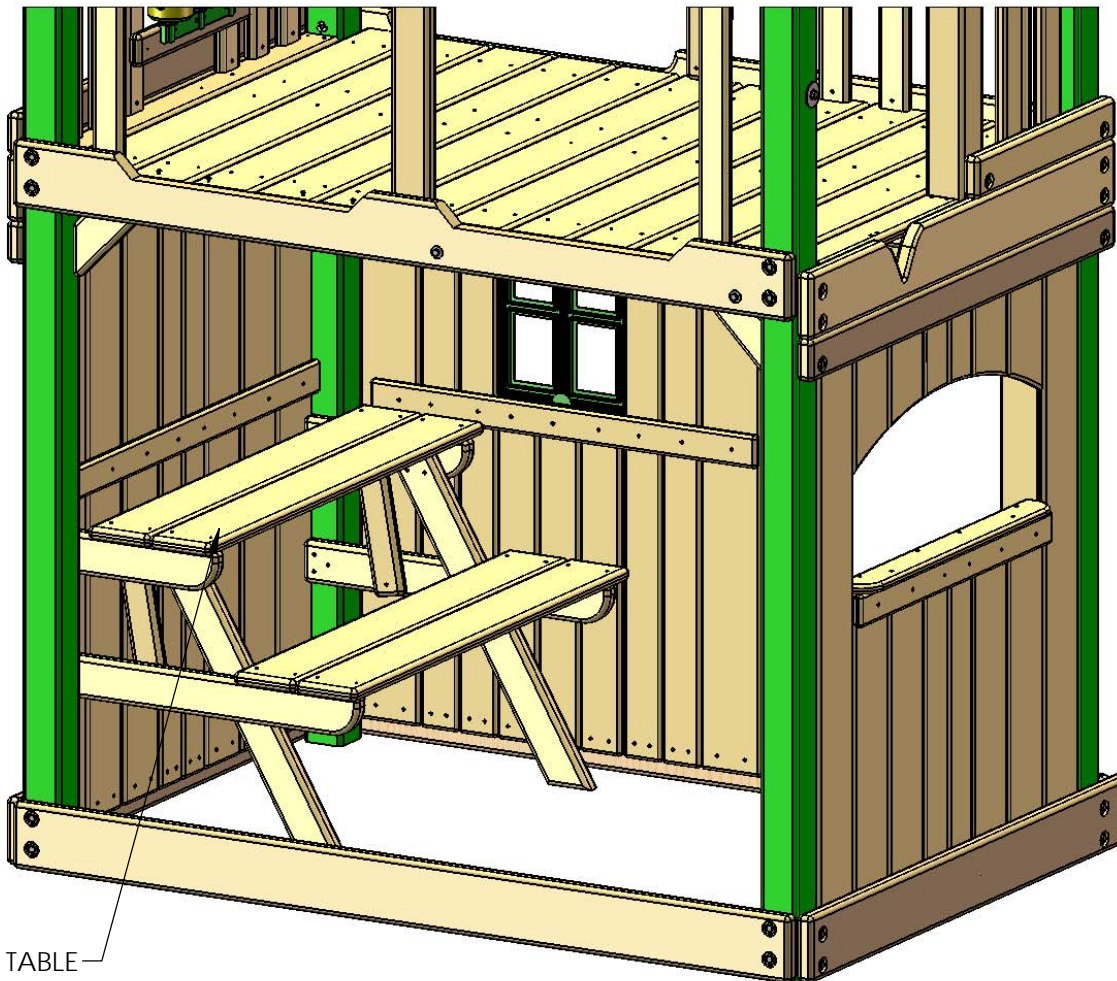

PICNIC TABLE

Model 1500CWR shown.
See cover of manual for the
image of your model when it
is completed.



Timber Shield Post Option
BOXES: X1, 120

**Models: 1500CWR
1500CWCR**

(BOXES: 1501, 1512, 1518*,
1528, 1529, Extreme Tube Slide
Box,
& Slide Box)

***1518 only included with
1500CWCR Clubhouse model**

REV: 1.27.2016

Amber Post Option
BOXES: 1533-2bx, 1522

TABLE OF CONTENTS

Safety Guidelines.....	Pages 3-6
Leveling Fort, General Information and Definitions.....	Pages 6-8
How to Install T-nuts, Board Identification, Predrill Lag Screw Directions and Swing Beam Loading.....	Pages 9-13
Site Plan, Required Tool List and Kit Contents.....	Pages 14-15
Hardware, Lumber and Accessory Checklists.....	Pages 16-35
Adding T-Nuts to Corner Posts.....	Step 1
Framing Fort.....	Steps 2-9
Mounting Deck.....	Step 10
Rock Wall Assembly/Installation.....	Steps 11-15
Ladder Assembly/Installation.....	Steps 16-17
Center Post and Panel Slat Installation.....	Steps 18-19
Swing Beam Assembly.....	Steps 20-27
Roof Assembly.....	Steps 28-33
Front Gable Assembly and Installation.....	Steps 34-35
Front Wall Assembly and Completion of Main Roof.....	Steps 36-40
Hanging Swings and Safety Board.....	Steps 41-42
Picnic Table Assembly and Installation.....	Steps 43-45
Rope Ladder Assembly/Installation.....	Step 46
Extreme Tube Slide, Side Panel Slats, Right Side Angle Supports.....	Steps 47-48
Slide, Rock Wall Rope, Safety Handles and Telescope.....	Steps 49-52
Tic Tac Toe Assembly/Installation.....	Steps 53-54
Sandbox Seats/Name Plate, Solar Wall Lights and Steering Wheel.....	Steps 55-57
Ground Stakes.....	Step 58
Leftover Parts List.....	Page 101
Appendix: Chimney and Dormer Instructions, etc.....	Page 102

PLEASE READ OWNER'S MANUAL CAREFULLY BEFORE STARTING ASSEMBLY!

Safety and Maintenance Tips for Your New Play Set:

NOTE: Your children's safety is our #1 concern. Observing the following statements and warnings reduces the likelihood of serious or fatal injury. Please review these safety rules regularly with your children.

- This play set is designed for the use of 4 occupants who have a combined weight not exceeding 800 pounds on the elevated floor, 3 occupants who have a combined weight of 425 pounds on the swing area, for a total Unit capacity of 7 occupants who have a combined weight of 1225. (This weight does not include any picnic table area(s).)
- On-site adult supervision is required.
- Teach children not to walk close to, in front of, behind, or between moving swings or other moving playground equipment.
- Teach children to sit in and never stand on swings
- Teach children not to twist the chains and ropes and not to loop them over the swing beam, since this may reduce the strength of the chain or rope.
- Teach children not to jump from swings or other playground equipment in motion.
- Teach children not to push empty seats. The seat may hit them and cause serious injury.
- Teach children to sit in the center of the swings with their full weight on the seats.
- Teach children not to use the equipment in a manner other than intended.
- Teach children to always go down slides feet first. Never slide headfirst.
- Teach children to look before they slide to make sure no one is at the bottom.
- Teach children to never run up a slide, as this increases their chances of falling.
- The parents should have the children dress appropriately with well-fitting shoes. Loose clothing such as scarves and ponchos should not be worn. Always take off, tie up or tuck in cords and drawstrings on children's clothing. These things can get caught on playground equipment and strangle a child.
- Teach children not to climb when the equipment is wet.
- Teach children to never jump from a fort deck. They should always use the ladder, ramp or slide.
- Teach children to never crawl or walk across the top of monkey bars or swing beam.
- Teach children to never crawl on top of a fort roof or on the outside of a tube slide.
- Verify that any suspended climbing ropes, chains, or cables are secured at both ends and that they cannot be looped around an adult hand.
- Teach children not to attach items to the playground equipment that are not specifically designed for use with the equipment, such as, but not limited to, jump ropes, clothesline, pet leashes, cables and chain as they may cause a strangulation hazard.
- Teach children to never wrap their legs around swing chain.
- Teach children to never slide down the swing chain.
- Teach children to remove their bike or other sports helmet before playing on the playground equipment.
- Teach children to NEVER look at the sun or other bright light through any accessory such as but not limited to a telescope, periscope or binoculars.

WARNING: Children must NOT use this play set until it has been completely assembled and inspected by an adult to insure it has been properly installed and the swing beam legs are anchored.

Safety and Maintenance Tips for Your New Play Set: (continued)

Playgrounds should be inspected on a regular basis. If any of the following conditions are noted, they should be removed, corrected, or repaired immediately to prevent injuries.

- Hardware that is loose, worn or that has protrusions or projections.
- Exposed equipment footings.
- Scattered debris, litter, rocks, or tree roots.
- Splinters, large cracks, and decayed wood components.
- Deterioration and corrosion on structural components, which connect to the ground.
- Missing or damaged equipment components, such as handholds, guardrails, swing seats.
- Check all nuts and bolts twice monthly during the usage season and tighten as required. (But not so tight that you crack the wood) We recommend you check the swing beam and hardware often due to wood expansion and contraction. It is particularly important that this procedure be followed at the beginning of each season.
- Remove plastic swing seats and take indoors or do not use when the temperature drops below 32°F. Reinstall swings and other swing equipment at the beginning of the usage season.
- Oil all metallic moving parts monthly during the usage period.
- Check all coverings for bolts and sharp edges twice monthly during usage season to be certain they are in place. Replace when necessary. It is especially important to do this at the beginning of each new season.
- Check swing seats, ropes, cables and chains monthly during usage season for evidence of deterioration. Replacement should be made of any swing seat that has developed cracks in the plastic seats. Ropes, cables and chains should be removed and replaced if excessive wear is found. Contact us for warranted replacement parts.
- Swing chains, rings, ropes, etcetera should always be fastened to a rotating swing hanger. NEVER attach a chain, ring, rope, etcetera to a stationary hanger such as but not limited to an eye bolt. Severe wear could occur leading to an injury.
- For rusted areas on metallic members such as monkey bars, hand supports brackets, etc.; sand and repaint, using a non lead-based paint meeting the requirements of Title 16 C.F.R. Part 1303. These requirements are available at: <http://www.cpsc.gov/>
- Inspect wood parts monthly. The grain of the wood sometimes will lift in the dry season causing splinters to appear. Light sanding may be necessary to maintain a safe playing environment. If you are treating your play set with stain regularly, it will help prevent severe checking/splitting and other weather damage.
- Once or twice a year, depending on your climate conditions, you must apply some type of protection (sealant) to the wood of your unit. Prior to the application of sealant, lightly sand any “rough” spots on your set. Please note this is a requirement of your warranty.
- Creating and maintaining the play set on a level location is very important. As your children play, your play set will slowly dig its way into the soil, and it is very important that it settles evenly. Make sure the play set is level and true once each year or at the beginning of each play season.
- Twice a month during the usage season rake the playground protective surfacing materials to prevent compaction and maintain appropriate depths. Replace the protective surfacing materials as required.
- Disposal Instructions: When the play set is no longer desired, it should be disassembled and disposed of in such away that no unreasonable hazards will exist at the time the play set is discarded.

Play Set Surfacing Recommendations:

Below are some of the recommendations that the U.S. Consumer Product Safety Commission (CPSC) offers from its Handbook for Public Playground Safety. The guide can be downloaded in full at www.cpsc.gov/cpscpub/pubs/325.pdf

1. Protective Surfacing - Since almost 60% of all injuries are caused by falls to the ground, protective surfacing under and around all playground equipment is the most critical safety factor on playgrounds.

Certain manufactured synthetic surfaces also are acceptable; however, test data on shock absorbing performance should be requested from the manufacturer.

Asphalt and concrete are unacceptable. They do not have any shock absorbing properties. Similarly, grass and turf should not be used. Their ability to absorb shock during a fall can be reduced considerably through wear and environmental conditions.

Certain loose-fill surfacing materials are acceptable. Surfacing materials are acceptable, such as the types and depths shown in the table.

Fall Heights and Materials

Type Of Material	6 in. depth	9 in. depth	12 in. depth
Double-Shredded bark mulch	6' Fall Height	10' Fall Height	11' Fall Height
Wood Chips	6' Fall Height	7' Fall Height	12' Fall Height
Fine Sand	5' Fall Height	5' Fall Height	9' Fall Height
Shredded Tires*	10-12' Fall Height	N/A	N/A
Fine Gravel	6' Fall Height	7' Fall Height	10' Fall Height

*This data is from tests conducted by independent testing laboratories on a 6-inch depth of uncompressed shredded tire samples produced by four manufacturers. The tests reported critical heights, which varied from 10 feet to greater than 12 feet. It is recommended that persons seeking to install shredded tires as a protective surface request test data from the supplier showing the critical height of the material when it was tested in accordance with ASTM F1292.

It should be recognized that all injuries due to falls cannot be prevented no matter what surfacing material is used.

2. Fall Zones - A fall zone, covered with a protective surfacing material, is essential under and around equipment where a child might fall. This area should be free of other equipment and obstacles onto which a child might fall. Stationary climbing equipment and slides should have a fall zone extending a Minimum of 6' in all directions from the perimeter of the equipment.

Swings should have a fall zone extending a minimum of 6' from the outer edge of the support structure on each side. The fall zone in front and back of the swing should extend out a minimum distance of twice the height of the swing as measured from the ground to the top of the swing support structure.

LEVELING YOUR FORT DURING ASSEMBLY

- Complete the steps which will be the basic frame of the fort. {i.e. four corner posts with base (sand box boards) and deck supports}
- Position in the most level area chosen for the play set, keeping in mind the location and size of the swing beam, ladder, slides, etc. that extend off the fort.
- Once the frame is in the final position, check for vertical and horizontal levelness to determine which side(s) will need to be dug into the ground to level the play set.
- With a shovel, score the ground around the outside edges of the sandbox boards on the 'high' side of the fort. This is the area that will be dug in. Make sure to score deep enough; the scored lines will be your digging template.
- Push the frame off and away from the scored area, far enough to dig and remove dirt to reach the appropriate depth.
- Dig a channel along the scored line(s) for the base of the fort (corner post and sandbox boards) to rest into. Dig the channel(s) to the same level depth. The bottom of the channel(s) should be level to each other so your frame doesn't teeter or rock because the channel(s) are uneven.
- Once you have removed enough grass and dirt, slide/push the frame into the channel(s). Place a level on the vertical and horizontal boards of the frame to determine if enough soil, or too much, was removed.
- Repeat this process until the basic frame is plumb and level and in its final position before completing the rest of the assembly.
- Measure to make sure fort is square.

Important: if you require a channel depth of more than 6", then we recommend you have your play set area professionally graded before completing assembly.

Example Play area:

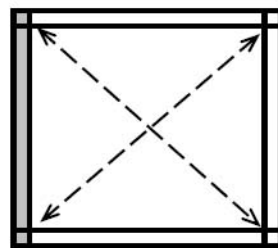
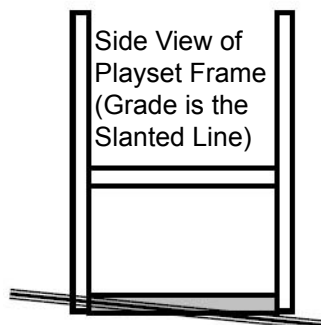

The diagonal measurements should be the same from corner post to corner post. If not, adjust corner posts so that the distance is equal.

■ = Area to be scored and channeled for levelness

General Info to Review Before Installation

- Depending on your experience, assembly of the playset can take as little as 6 hours up to 24 hours, depending on size, after inventory of parts; therefore, we recommend you set aside a full two days for assembly.
- Identify all of the parts for your play set. Empty each box and lay out boards so you can see each part. Your instruction book will have detailed drawings that will make it easy for you to recognize individual parts. Keep all hardware and metal parts separate from wooden pieces.
- After everything is laid out, check carefully to ensure all parts are present. Make sure there are no broken boards.
- Find an area to sort your hardware. It is best to open the hardware on a solid surface so that you do not lose any pieces in the grass. This will save time and familiarize you with all the different pieces in the hardware bag.
- Important note: Wood has some natural defects such as knots, surface cracks, etc... We reject parts that are structurally defective. We use a high quality lumber in our structures; however, you should inspect each part for splinters or rough spots and sand them smooth to prevent injury.
- After familiarizing yourself with all of the components, read all instructions thoroughly. Reading instructions after you have studied the parts will help you understand the installation process, and help to eliminate unnecessary mistakes.
- Pay close attention to the diameter and length of each bolt and screw.
- Never tighten hardware completely at first. It helps to have some adjustment for bolt alignment while you are attaching parts together. After everything is square, tighten each joint.
- After the main unit is assembled it is critical that the floor is level and square. If the main frame is not level, the walls and floor will be out of square.
- After you complete installation, make sure every bolt, screw, and nut is tight, and every board is secure. Wood will expand and contract with the seasons.
- Place the set on level ground, not less than 6 feet from any structure or obstruction such as a fence, garage, house, overhanging branches, laundry lines, or electrical wires.

This page is a list of definitions and explanations used throughout our instructions to aid you in the assembly of your play set.

Offset Holes- Throughout the installation procedures we will refer to parts with offset holes. This refers to the orientation of the holes on the board. An offset hole is one that is closer to one side than it is the other or in other words, it is not centered on the board. In the procedures you will be instructed to attach the boards with the holes offset up or with the holes offset down. This refers to which side of the board the hole/holes should be closer to. Offset holes up= hole/holes will be closer to the top of the board. Offset holes down= hole/holes will be closer to the bottom of the board. Note: some parts do not have offset holes, but instead the holes are on center. Therefore there will not be any reference on how to offset these parts.

EXAMPLE OF OFFSET HOLES UP

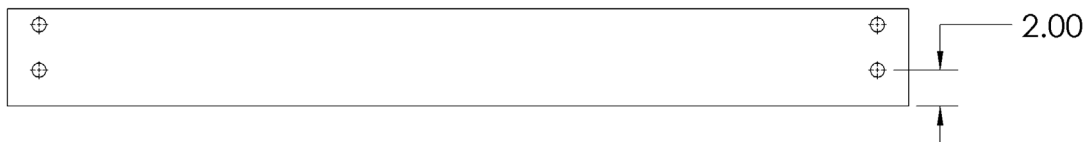

EXAMPLE OF OFFSET HOLES DOWN



Counter-sunk holes - Many of the parts that will be used have counter-sunk holes. A counter-sunk hole is one that surrounds one side of a through hole, but does not extend through the wood it's self. When using a counter-sunk hole the bolt will be inserted through the through hole and either the head of the bolt and washer or nut and washer will occupy the counter sunk hole.

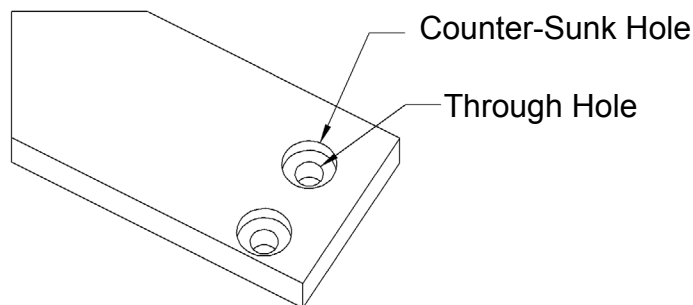

Lag Screws- Lag screws are used in the construction of our play sets to enhance the structural integrity of the unit. There will not be predrilled holes in the post for lag screw installation. Lag screws are self-tapping, though if you are using a manual socket wrench it may be advantageous to pre-drill a hole first. Instructions for this are provided on a separate page in the front of the manual. Be sure to tighten the lags completely when driving them in by hand. Power tools such as a heavy duty impact driver or large power drill should have enough torque to drive in the lag screws, but make sure not to over tighten as this can cause the threads to “strip out” in the post.

Common Installation Practice Installing T-nuts

When installing T-nuts into the wood, use a smooth faced hammer to set the face of the T-nut flush into the wood.

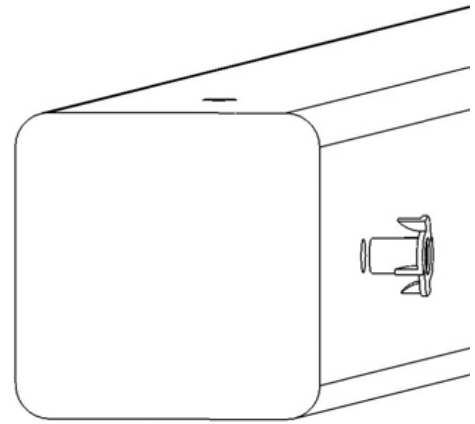
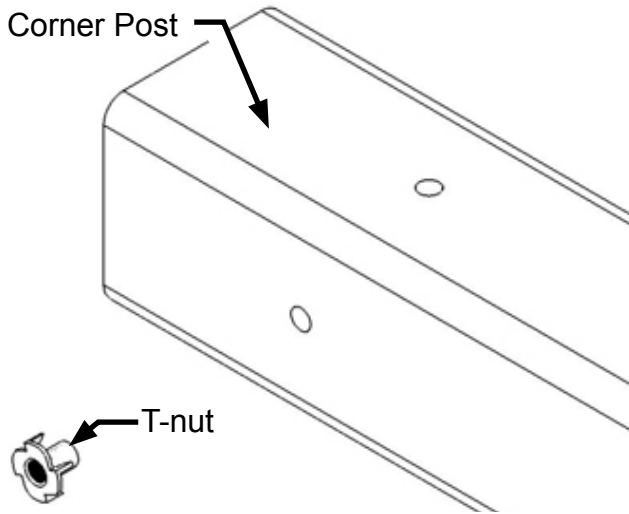

Insert the barrel of the T-nut into the predrilled hole. Using a smooth faced hammer, drive the T-nut until the face of the T-nut is flush to the wood.

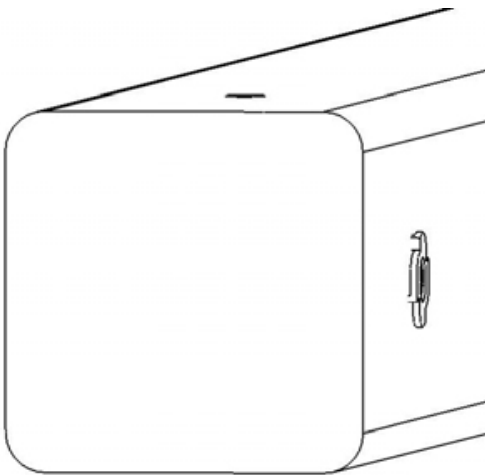

This picture shows the T-nut inserted and installed flush to the wood.



This picture shows an end view of the T-nut installed flush to the wood.

WARNING: DO NOT EMBED THE TOP OF THE T-NUT INTO THE FACE OF THE WOOD

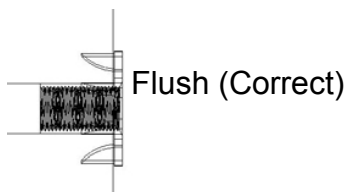

Cross Section end view, you are looking at an X-ray view of the post and T-nut. The barrel of the T-nut is in the corner post the line is the face of the wood.

HOW A T-NUT WORKS

THE FIRST STEP IN OUR ASSEMBLY INSTRUCTIONS IS TO INSERT T-NUTS INTO THE CORNER POSTS. A T-NUT IS A FASTENER WHICH IS THREADED ON THE INSIDE AND IT FUNCTIONS JUST LIKE A STANDARD HEX NUT. YOU INSERT THE T-NUTS INTO THE PREDRILLED HOLES IN THE CORNER POSTS.

THE T-NUT HAS A BARREL SHAPED END WHICH GOES INTO THE HOLE IN THE CORNER POST. THE T-NUT ALSO HAS AN FLANGE SHAPED END WITH TEETH. THE TEETH PENETRATE INTO THE CORNER POST WOOD TO PREVENT THE T-NUT FROM SPINNING WHEN YOU TIGHTEN THE HEX HEAD BOLT.

SHOWN BELOW YOU WILL SEE THE T-NUT IS HAMMERED INTO THE CORNER POST ON THE BACK SIDE. THE BOARD IS BEING ATTACHED ON THE FRONT SIDE OF THE CORNER POST.

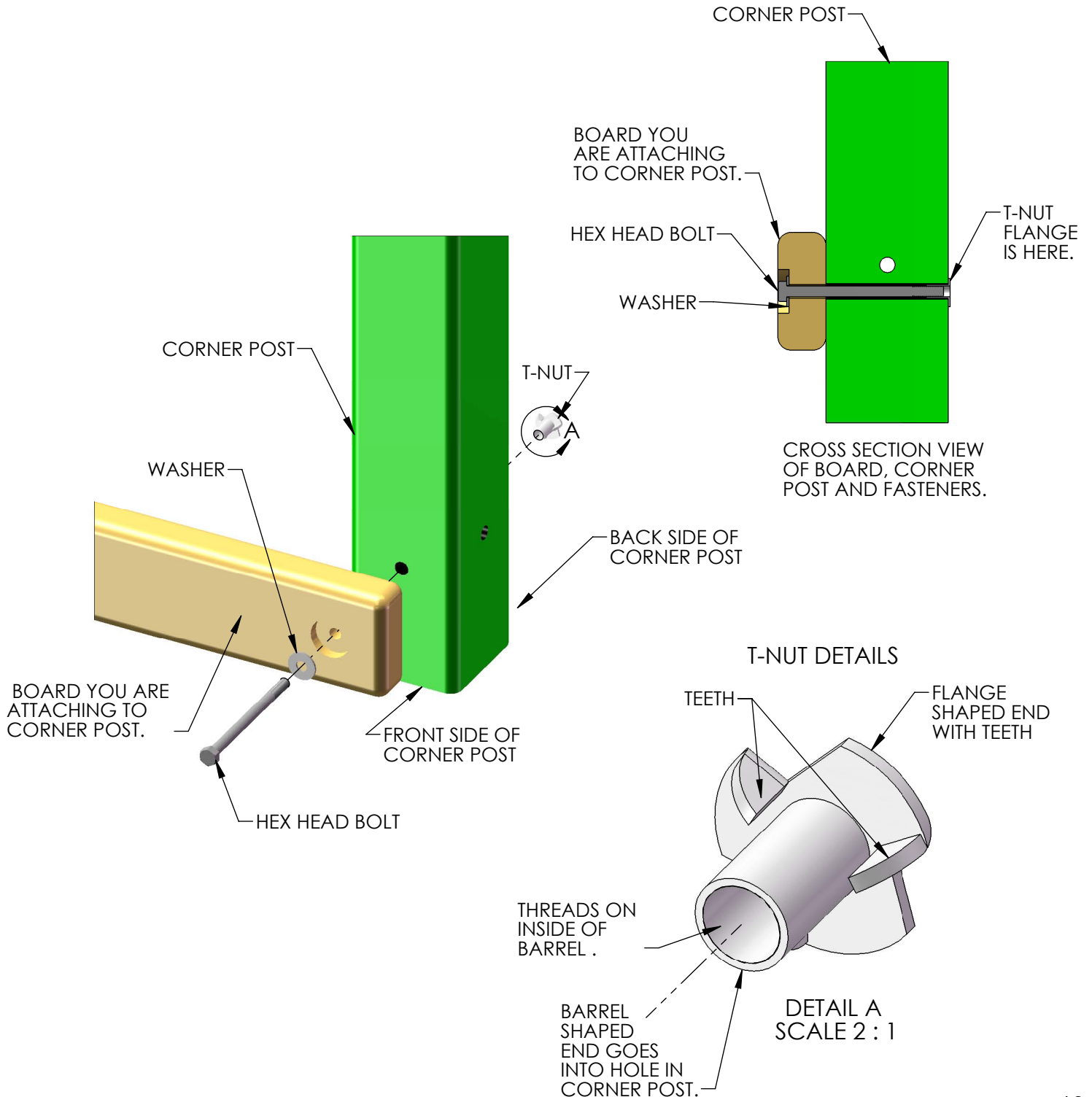

BOARD IDENTIFICATION

1. On the end of each board there should be a small white tag that is stapled or stuck into place. Remove the staples and/or tag after the board is installed.
2. This white identification tag displays the thickness, width, length and an abbreviated description of the part.

Example: a tag reads "2-4-3600-BPB"

- The 2 is the thickness of the board. "Nominal Lumber" at a home center will measure 1-1/2" for the thickness. We "remill" that lumber to 1-3/8" thick.
- The 4 is the width of the board. "Nominal Lumber" at a home center will measure 3-1/2" for the width. We "remill" that lumber to 3-3/8" wide.
Note: sometimes the width will be smaller than 3-3/8" because:
A) We need the width of the part to fit into a certain area of the play set.
B) We need the designation to be simple.
- The 3600 is the length of the board. It means the board is 36 inches long. If the code were 3625 then the board is 36-1/4" in length.
- The "BPB" abbreviation stands for "Bottom Panel Board". The wood part bill of materials in the instructions has a description which will match the abbreviation closely.
- In the event that there is no tag on a wood part measure the part then:
A) Use the measurements and compare them to the wood list at the front of the instructions to identify it.
B) Look at the holes on the wood part and compare them to the pictures in the wood list.
C) Look to see if the holes are centered or if they are offset up or offset down.
This should help you identify any parts that have missing tags. In the event that you cannot identify a board please email us for assistance.

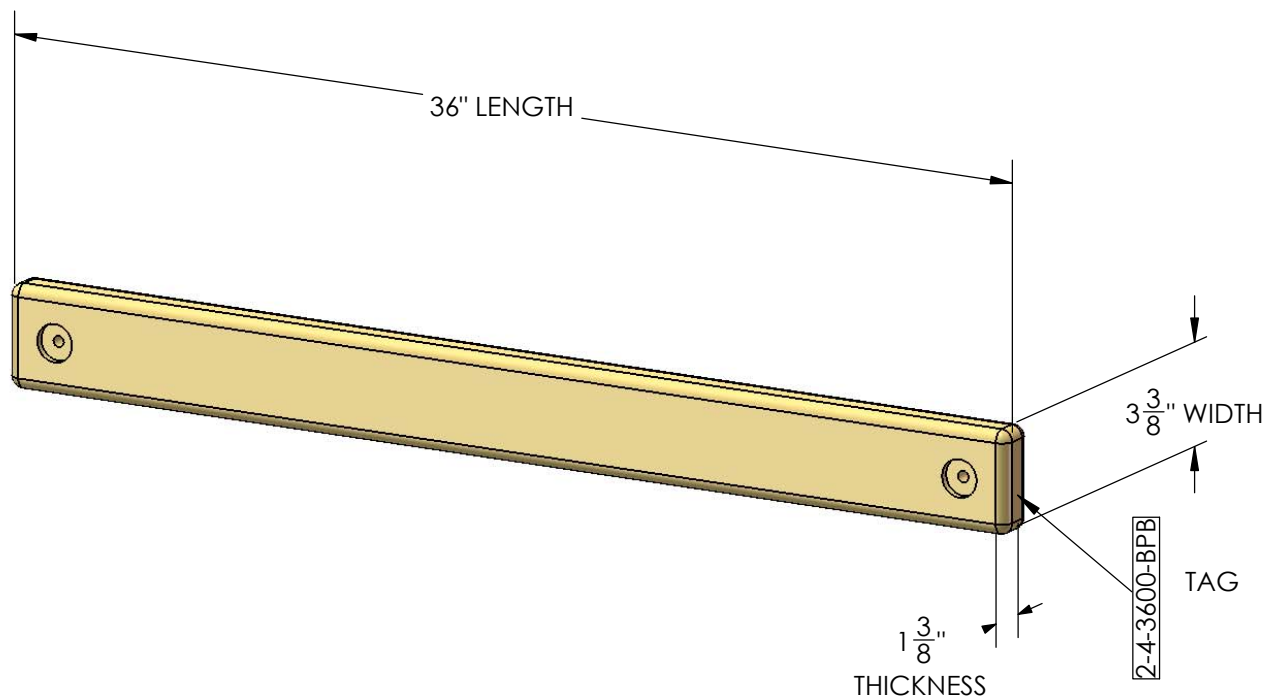

PRE-DRILL LAG SCREW DIRECTIONS

Pre-drilling holes for lag screws will make it easier to drive the screws in by hand. "Jobber" length drill bits are available in sizes that are longer than standard drill bits and those are ideal for the job. When using the drill bit you will have to "spot" drill the post and then remove the board you are attaching to finish drilling the hole.

Pay attention to the *DIAMETER* of the lag screw you are installing. Your playset may come with two different diameter lag screws. Each diameter will require a different size drill bit. When installing lag screws **DO NOT OVERTIGHTEN.**

LAG SCREW DIAMETER	DRILL BIT SIZE
5/16" DIAMETER	9/64"
3/8" DIAMETER	11/64"

Example: 3/8" diameter x 3-1/2" lag screw

This would be like the 2 x 4 board installation shown below. Place the board into position. Spot Drill through the holes in the 2 x 4 board into the corner posts with an 11/64" drill bit. Remove the 2 x 4 board. Continue to drill the holes to a total depth of 2-5/16" as shown at the right. Install the 2 x 4 board.

Example 5/16" diameter x 3-1/2" lag screw

This would be like the 2 x 4 board installation shown below. Place the board into position. Spot Drill through the holes in the 2 x 4 board into the corner posts with an 9/64" drill bit. Remove the 2 x 4 board. Continue to drill the holes to a total depth of 2-5/16" as shown at the right. Install the 2 x 4 board.

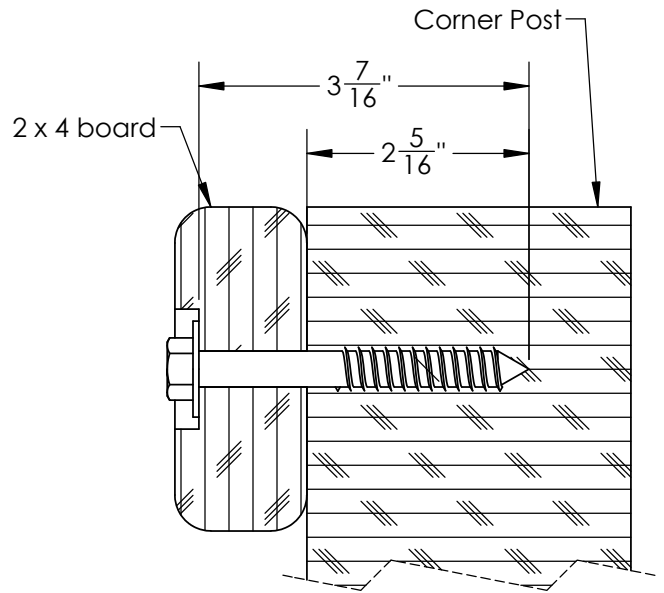

Example 3/8" diameter x 5" lag screw

This would be like the 4 x 4 board installation shown below. Place the board into position. Spot drill through the holes in the 4 x 4 board into the corner posts with an 11/64" drill bit. Remove the 4 x 4 board. Continue to drill the holes to a total depth of 2-13/16" as shown at the right. Install the 4 x 4 board.

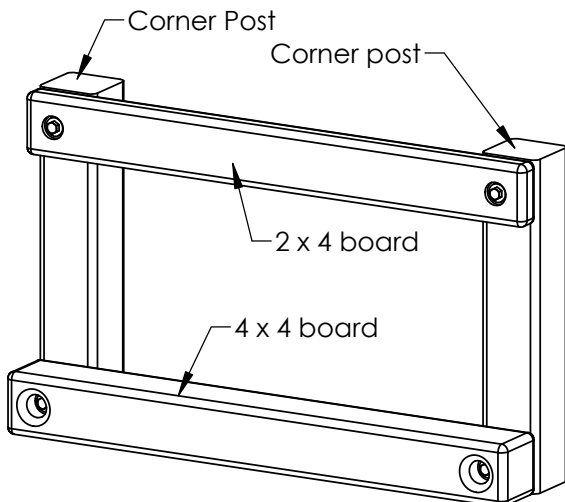
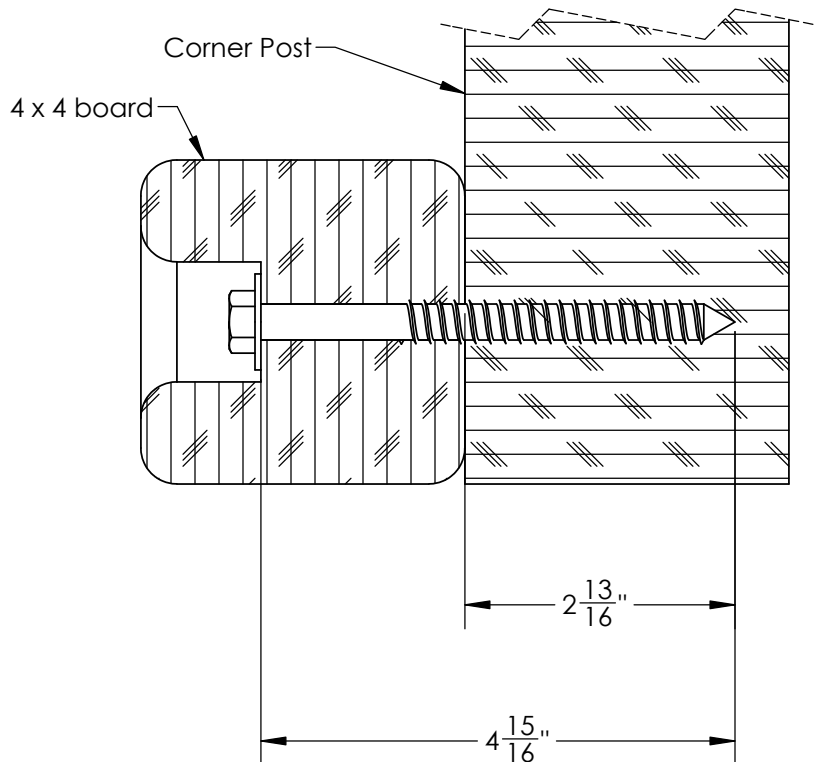

SWING BEAM LOADING

Weight Limits for Accessories:

The weight limit for a Swing Belt is 225 lbs. (Although 150lbs is the maximum recommended swinging weight capacity for the swing position.)

The weight limit for a Trapeze Bar is 125 lbs.

Maximum Allowable swinging weight for a three position swing:

- 1) The maximum allowable swinging weight at each Swing Belt position is 150 lbs.
- 2) The maximum allowable swinging weight at the Trapeze position is 125 lbs.
- 3) The MAXIMUM SWING BEAM LOAD IS 425 lbs.

MAXIMUM SWING BEAM LOAD IS 425 LBS.

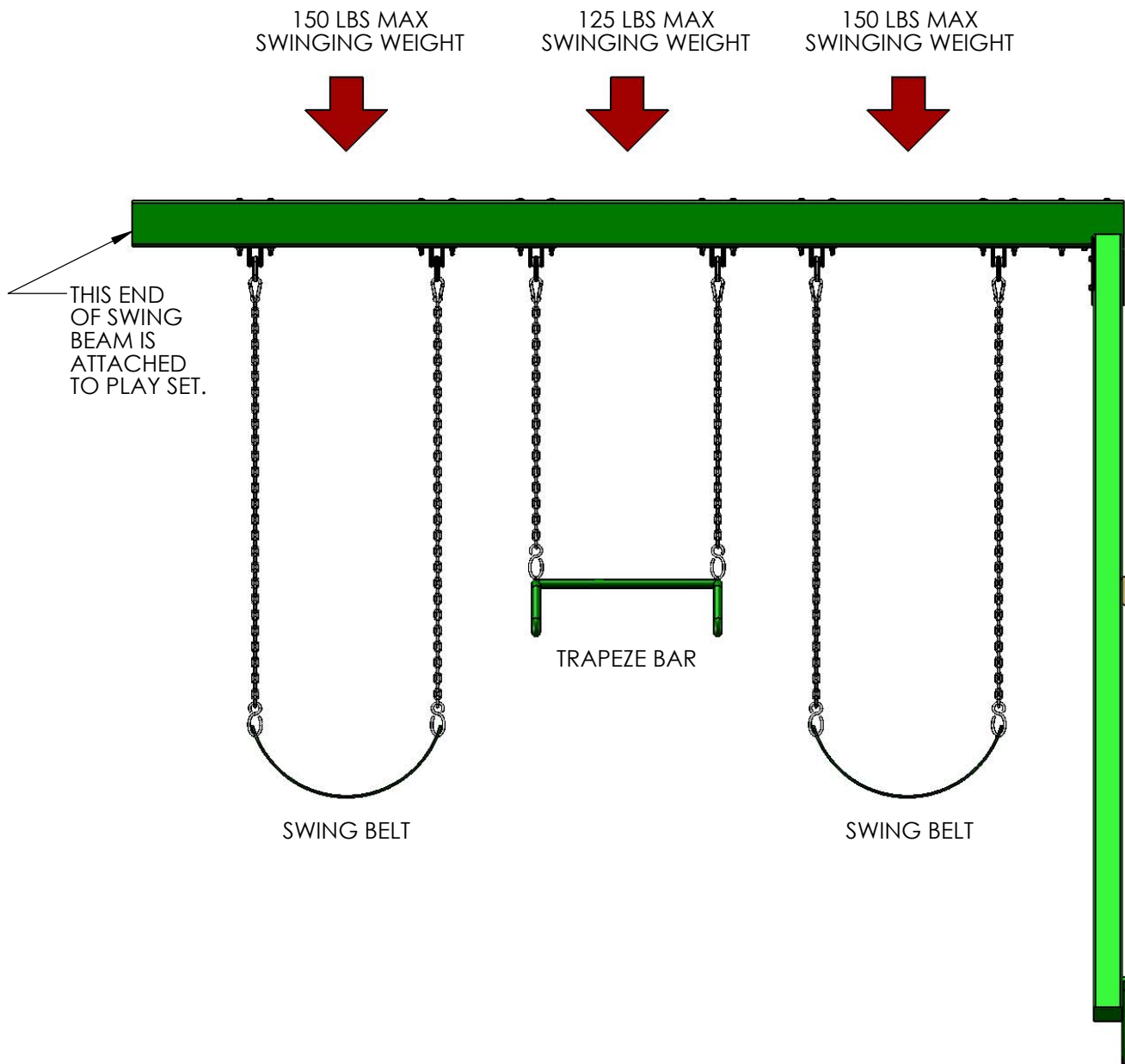

Please familiarize yourself with the manual, parts/components and general construction process of your new playset before getting started.

SITE PLAN:

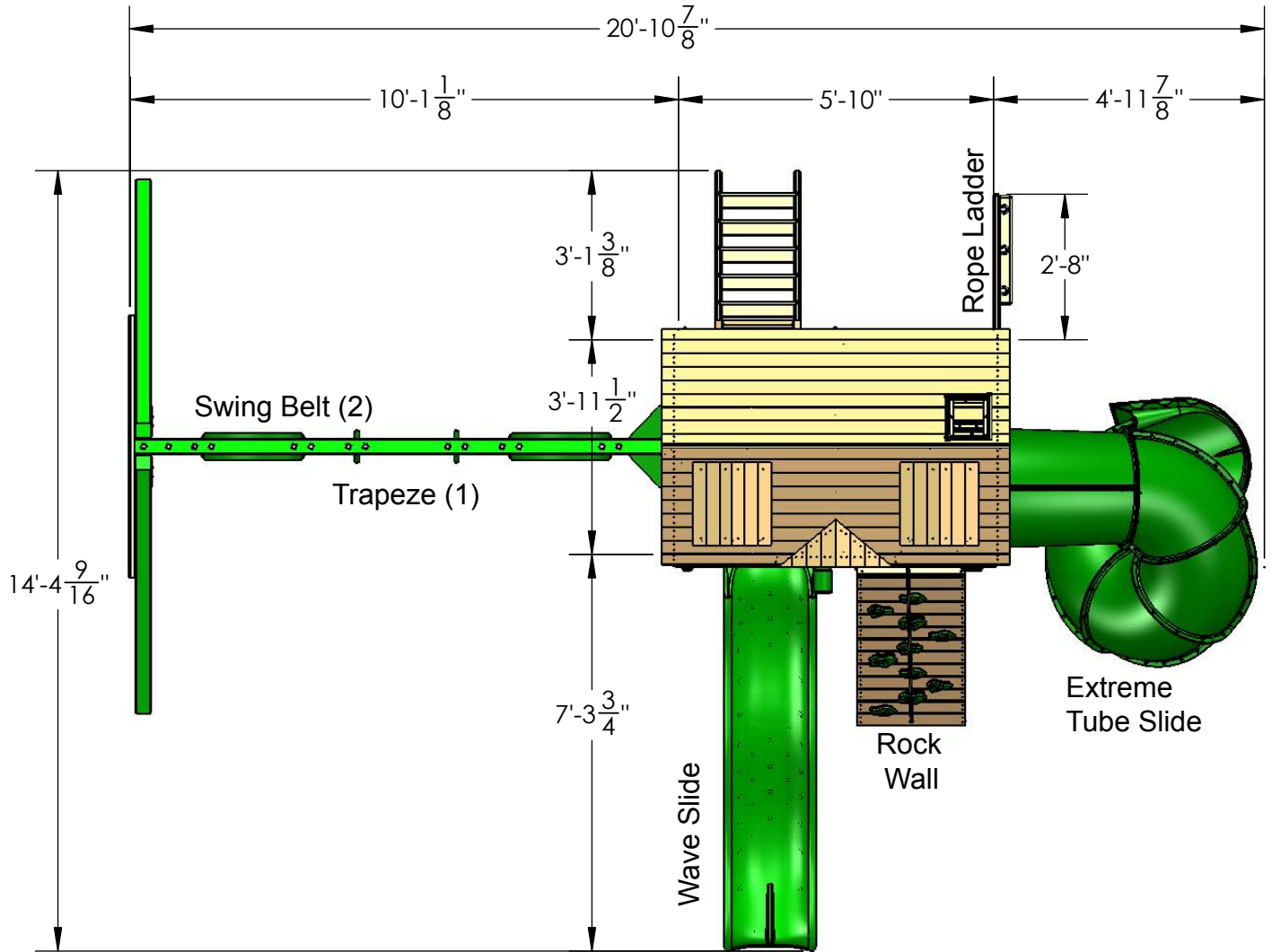

Playset height: 12 feet

Swing Beam height: 7 feet - 7-1/2 inches

Deck height: 5 feet

Approximate assembly time: 12-16 hours

(6) foot unobstructed safety perimeter around playset recommended

REQUIRED TOOL LIST:

- ___ Standard or Cordless Drill w/ Phillips Bit (#2 square bit provided)
- ___ Drill Bits 1/8", 3/16", 3/8", 9/64", 11/64".
- ___ 1/2" Wrench and Socket
- ___ 1/2" Deep Well Socket
- ___ 9/16" Deep Well Socket
- ___ 9/16" Wrench and Socket
- ___ Level
- ___ Tape Measure
- ___ Extension Cord (if using standard drill)
- ___ Hammer
- ___ Pencil
- ___ Locking Pliers (Vise Grips)
- ___ Shovel
- ___ Marker or Tape (Step 46)

KIT CONTENTS

Swings, Slides, Accessories:

- ___ (Qty) Description
- ___ (2) Swingbelt w/ Chains
- ___ (1) Trapeze Swing w/Chains
- ___ (1) Wave Slide
- ___ (10) Rock Wall Grips (assorted colors)
- ___ (1) Telescope
- ___ (1) Safety Handles (pair)
- ___ (2) Solar Wall Light
- ___ (1) Front Plastic Arch 07-0027-G
- ___ (2) Plastic Sunburst 07-0028-G
- ___ (2) Plastic Dormer Window 07-0029-G
- ___ (1) Logo Plate
- ___ (1) Ground Stakes (pair)
- ___ (1) Tic Tac Toe
- ___ (1) Steering Wheel
- ___ (1) Extreme Tube Slide

Fort Hardware:

see following pages

Swing Beam Hardware:

see following pages

Wood Components:

see following pages



#14 X 1-1/4"
 PAN HEAD SCREW
 QTY: 4

#8 X 1"
 WOOD SCREW
 QTY: 2



#8 X 1-3/4"
 WOOD SCREW
 QTY: 4



#8 X 2"
 WOOD SCREW
 QTY: 189



#8 X 2-1/2"
 WOOD SCREW
 QTY: 52



#8 X 3"
 WOOD SCREW
 QTY: 20

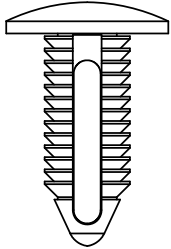

3/8" ϕ X 1-1/8"
 BLACK PLASTIC
 PLUG
 QTY: 6

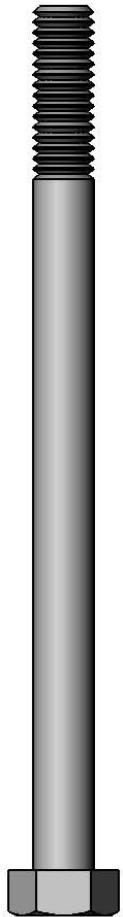

5/16 X 4-1/2"
 HEX BOLT
 QTY: 14

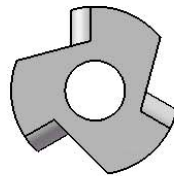

5/16" TEE NUT
 QTY: 22

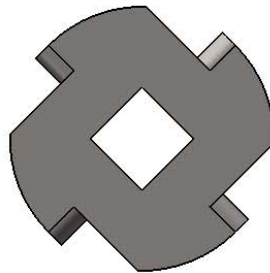

TORQUE WASHER
 QTY: 17

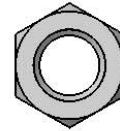

3/8" LOCK NUT
 QTY: 19

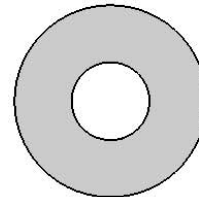

3/8" WASHER
 QTY: 31



5/16 X 1-1/2"
 HEX BOLT
 QTY: 8

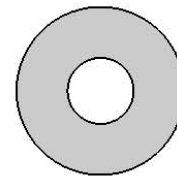

5/16" WASHER
 QTY: 34

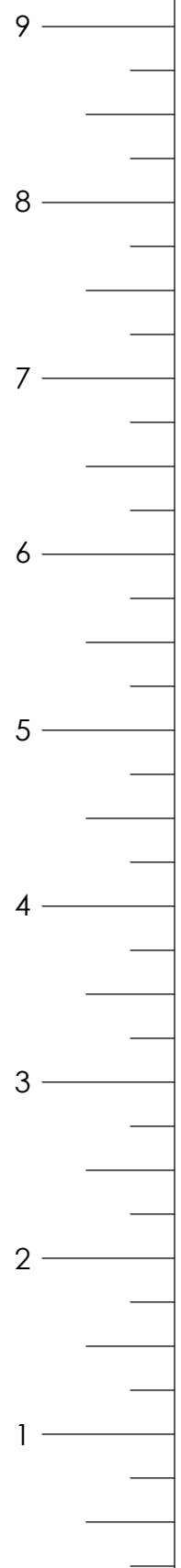

USE THE RULER TO THE RIGHT TO MEASURE YOUR BOLTS AND SCREWS. PICTURE VIEWS SHOWN ABOVE ARE 1:1 SCALE AND CAN BE USED TO MATCH BOLT AND SCREW SIZES.

1501 HARDWARE
 PAGE: 2 OF 2
 REV A: 9/10/2014 JH

5/16" X 3-1/2"
 HEX LAG
 SCREW
 QTY: 12

3/8 X 3-1/2"
 HEX LAG SCREW
 QTY: 12

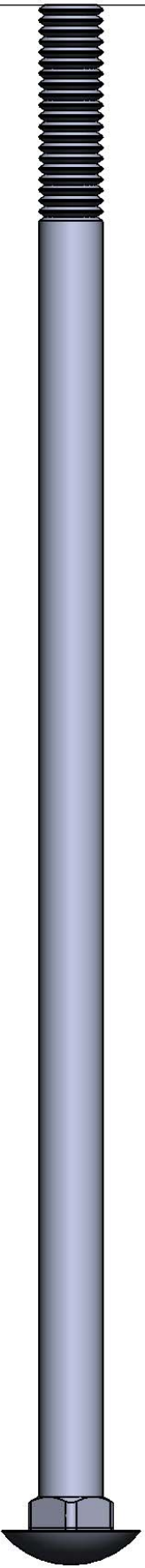

3/8 x 9"
 CARRIAGE BOLT
 QTY: 1

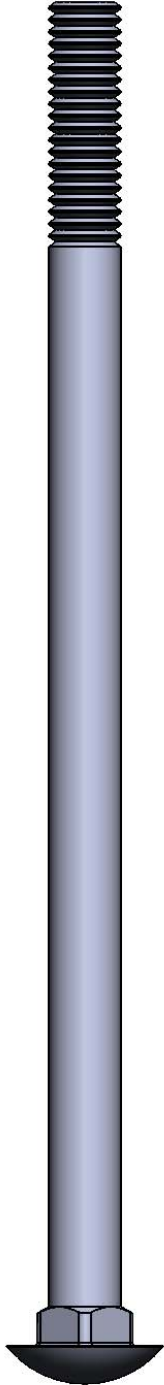

3/8 x 7"
 CARRIAGE BOLT
 QTY: 14

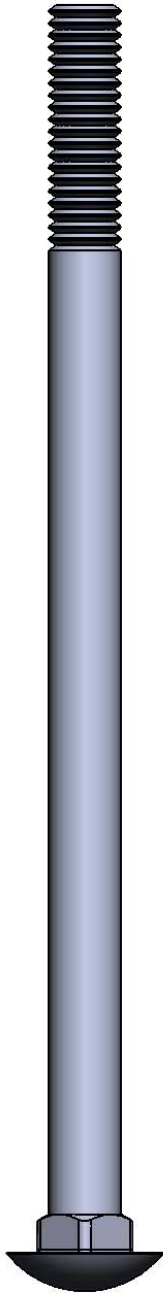

3/8 x 6-1/2"
 CARRIAGE BOLT
 QTY: 2

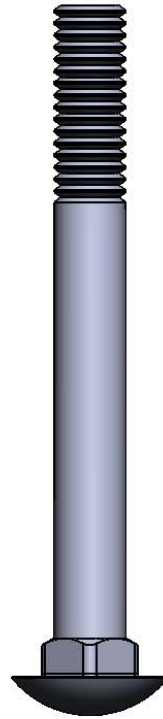

3/8 x 3-1/2"
 CARRIAGE BOLT
 QTY: 2

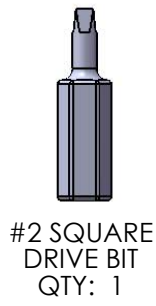
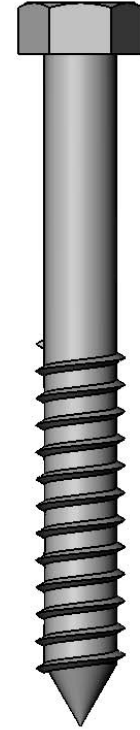
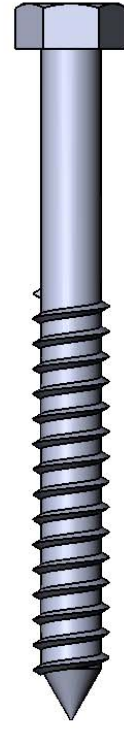

#2 SQUARE
 DRIVE BIT
 QTY: 1



PLASTIC
 BOLT CAP
 QTY: 19

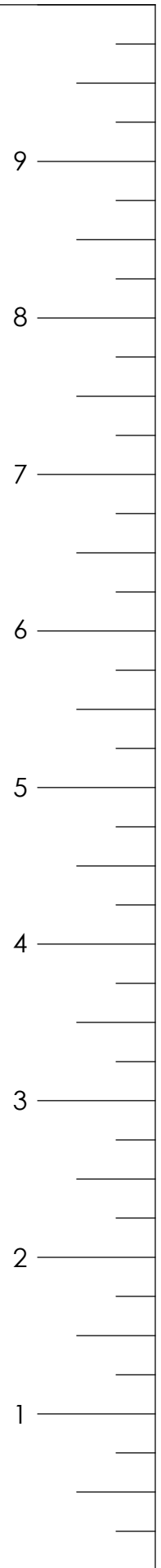

USE THE RULER TO THE RIGHT TO MEASURE YOUR BOLTS AND SCREWS. PICTURE VIEWS SHOWN ABOVE ARE 1:1 SCALE AND CAN BE USED TO MATCH BOLT AND SCREW SIZES.

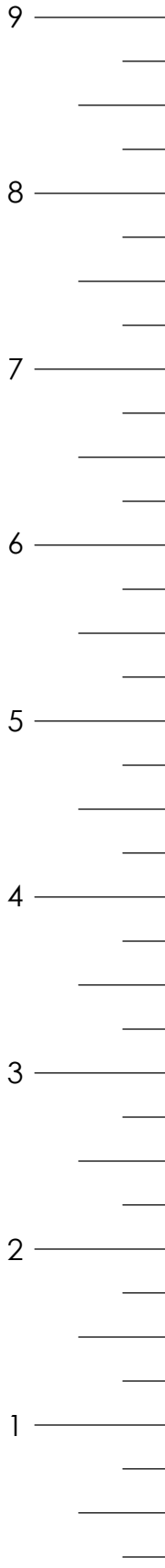

#8 X 2"
WOOD SCREW
QTY: 35



#8 X 2-1/2"
WOOD SCREW
QTY: 6



#8 X 3"
WOOD SCREW
QTY: 3

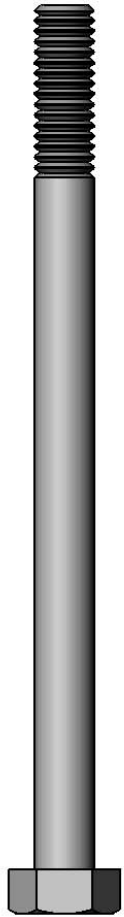

5/16 X 4-1/2"
HEX BOLT
QTY: 10

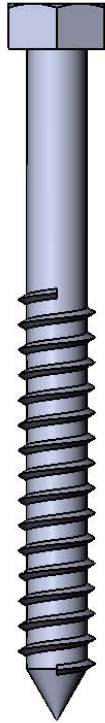

5/16" X 3-1/2"
LAG SCREW
QTY: 14

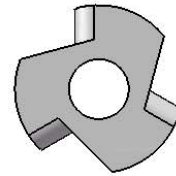

5/16" TEE NUT
QTY: 10

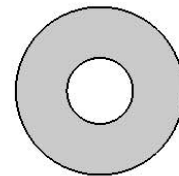

5/16" WASHER
QTY: 24

USE THE RULER TO THE RIGHT TO MEASURE YOUR BOLTS AND SCREWS. PICTURE VIEWS SHOWN ABOVE ARE 1:1 SCALE AND CAN BE USED TO MATCH BOLT AND SCREW SIZES.

#8 X 1"
WOOD SCREW
QTY: 2



#8 X 1-1/4"
WOOD SCREW
QTY: 25



#8 X 1-1/2"
WOOD SCREW
QTY: 110



#8 X 2"
WOOD SCREW
QTY: 25



#8 X 2-1/2"
WOOD SCREW
QTY: 12

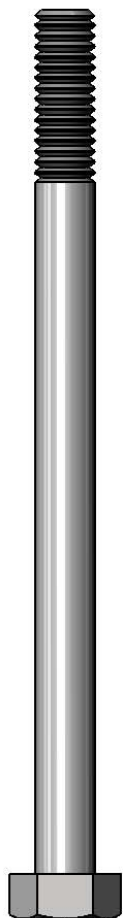

5/16" X 4-1/2"
HEX BOLT
QTY: 4



5/16" X 2-1/2"
HEX BOLT
QTY: 2

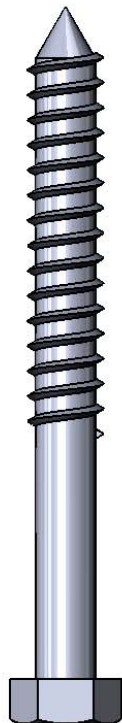

5/16" X 3-1/2"
LAG SCREW
QTY: 6



#2 SQUARE
DRIVE BIT
QTY: 1

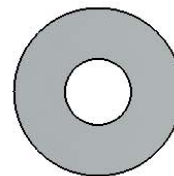

5/16" WASHER
QTY: 12

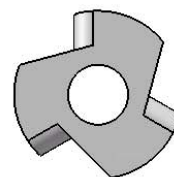

5/16" TEE NUT
QTY: 6

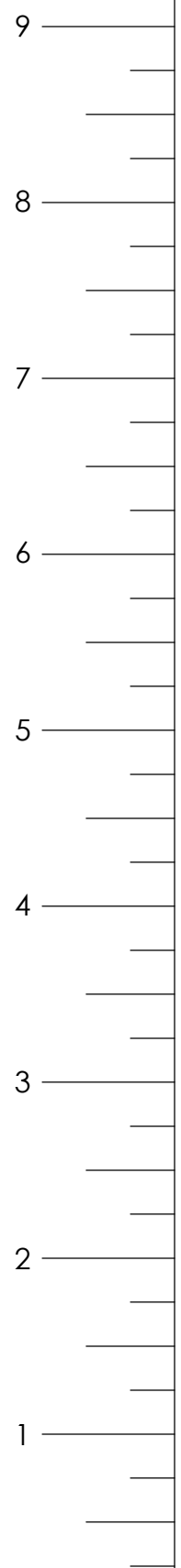

USE THE RULER TO THE RIGHT TO MEASURE YOUR BOLTS AND SCREWS. PICTURE VIEWS SHOWN ABOVE ARE 1:1 SCALE AND CAN BE USED TO MATCH BOLT AND SCREW SIZES.

PICTURE	DESCRIPTION	QTY.
	<p>2 X 4 X 13" ANGLE SUPPORT 2-4-1300-AS</p> <p>2 X 4 X 18" ANGLE SUPPORT 2-4-1800-AS</p>	<p>4</p> <p>4</p>
	<p>2 X 4 X 14-3/4" PICNIC TABLE TOP SUPPORT 2-4-1475-PTTS</p>	<p>2</p>
	<p>2 X 4 X 17" LADDER STEP 2-4-1700-LS</p>	<p>5</p>
	<p>2 X 4 X 21-1/2" END PANEL BOARD 2-4-2150-EPB</p>	<p>1</p>
	<p>2 X 4 X 22.75" WALL PANEL SUPPORT (1 HOLES ON CENTER) 2-4-2275-WPSL 2-4-2275-WPSR</p>	<p>1 LEFT</p> <p>1 RIGHT</p>
	<p>2 X 4 X 24" ROPE LADDER STEP 2-4-2400-RLST</p>	<p>6</p>
	<p>2 X 4 X 27-1/2" PICNIC TABLE SEAT SUPPORT 2-4-2750-PTTS</p>	<p>2</p>

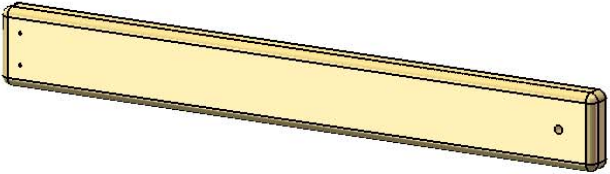
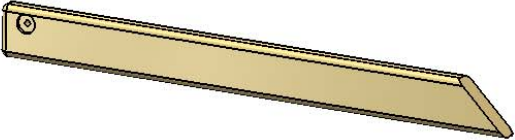
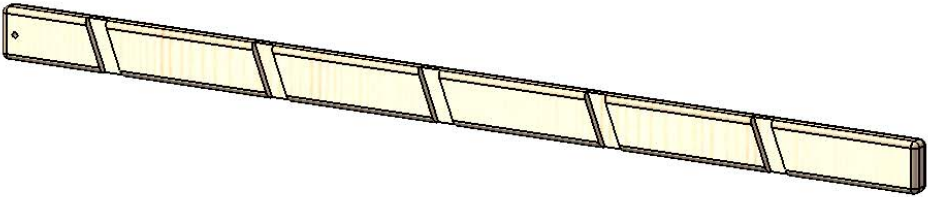
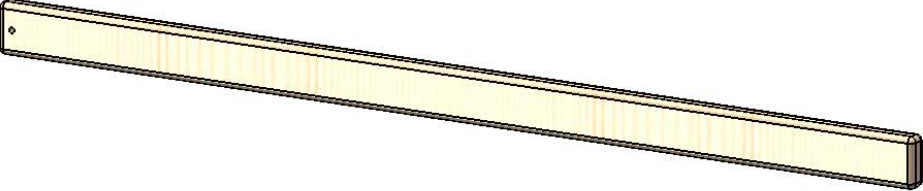
PICTURE	DESCRIPTION	QTY.
	2 X 4 X 28-9/16" CENTER POST FRONT/REAR 2-4-2856-CPFR	2
	2 X 4 X 32-1/2" PICNIC TABLE LEG 2-4-3250-PTL	2
	2 X 4 X 35.15" ROOF SUPPORT (1 HOLE OFFSET) 2-4-3515-RSL 2-4-3515-RSR	2 LEFT 2 RIGHT
	2 X 4 X 47 ¹ / ₂ " BOTTOM PANEL/ SAFETY BOARD (2 HOLES OFFSET) 2-4-4750-SBEP	2
	2 X 4 X 58" SWING BEAM CROSS MEMBER (2 HOLES ON CENTER) 2-4-5800-CM	1
	2 X 4 X 66" LADDER SIDE 2-4-6600-LLS 2-4-6600-LRS	1 LEFT 1 RIGHT
	2 X 4 X 66" ROCK WALL SIDE (1 HOLE ON CENTER) 2-4-6600-RWS	2

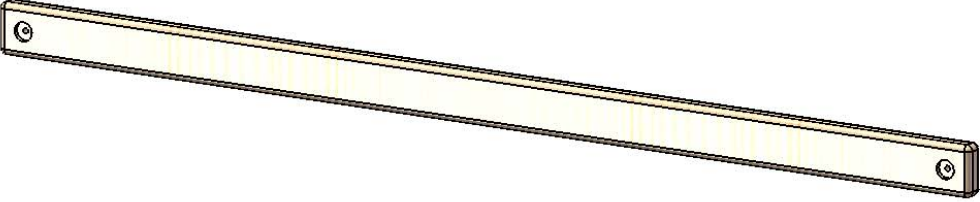
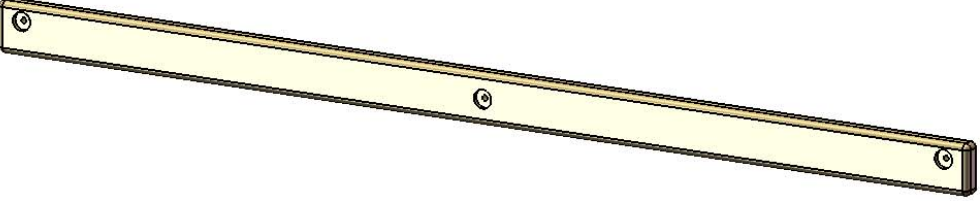
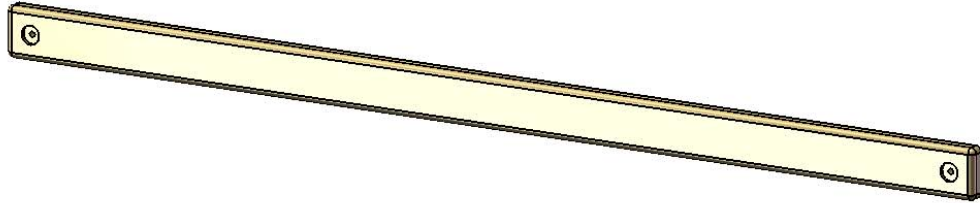
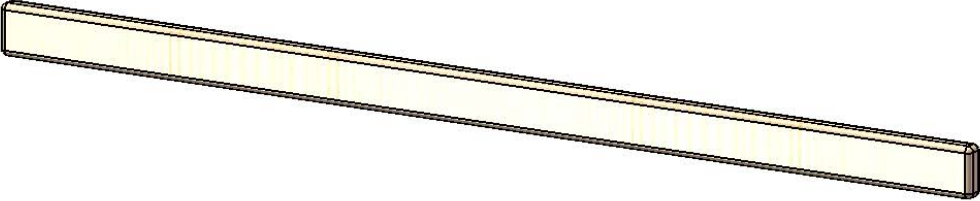
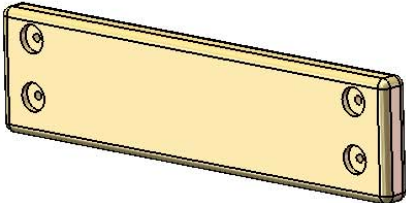
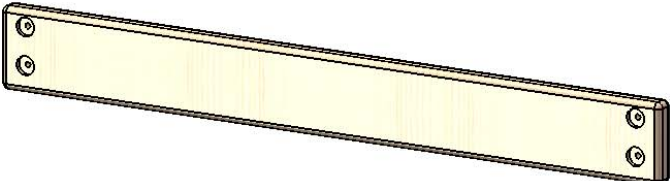
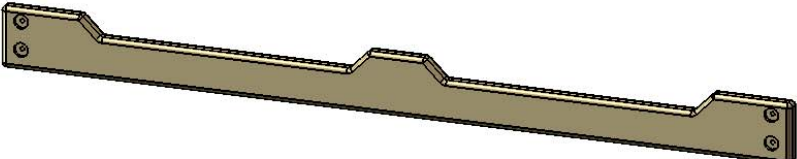

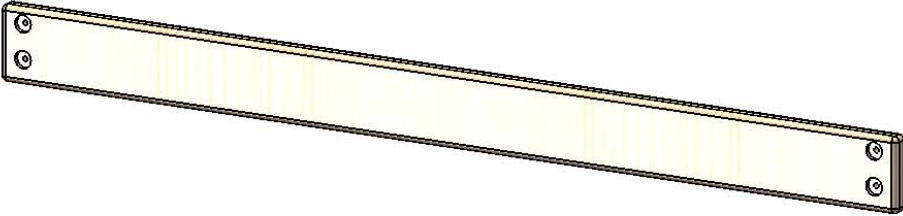
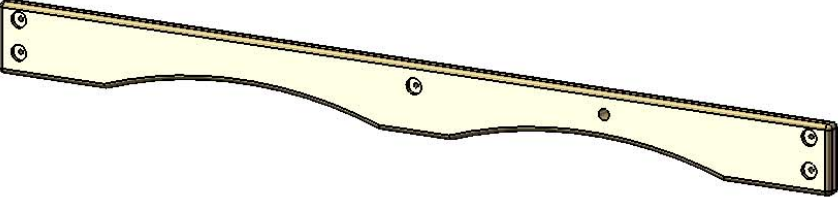
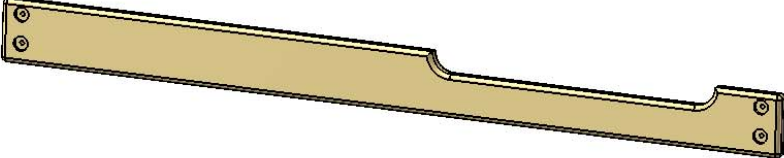
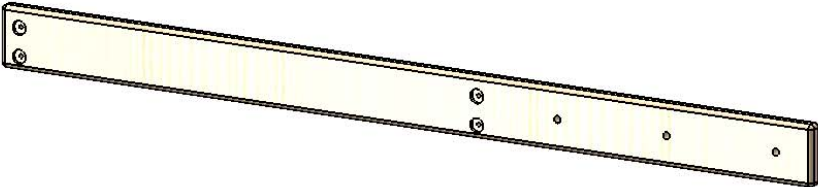
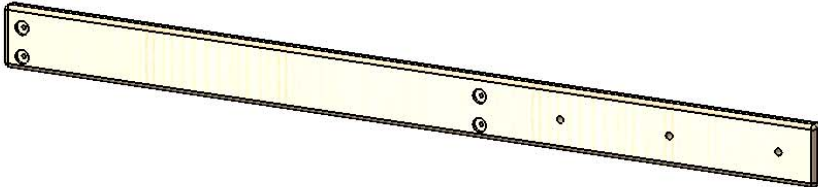
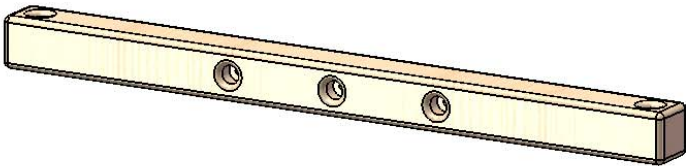
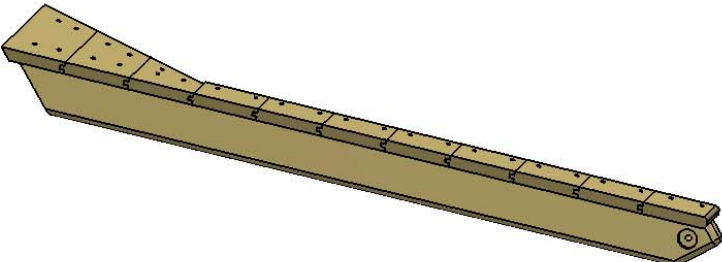



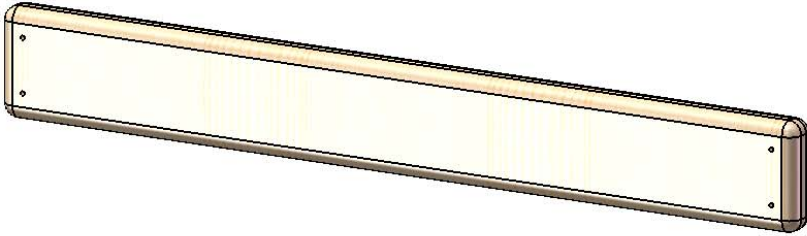
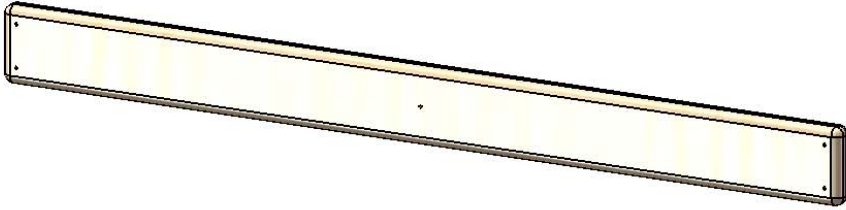
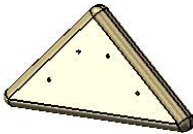
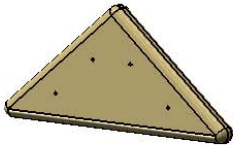
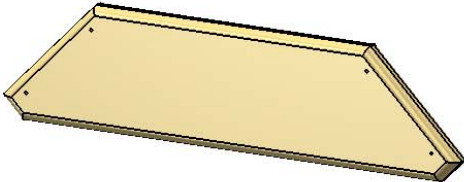
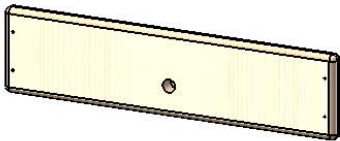
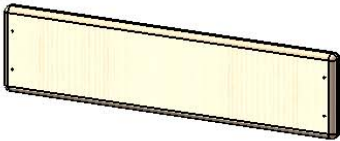

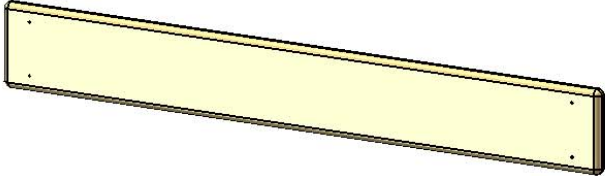
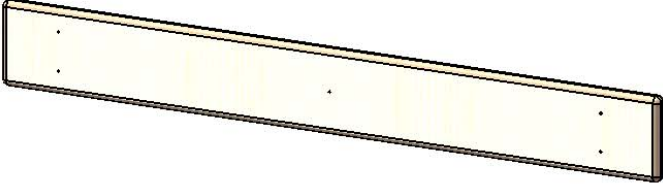
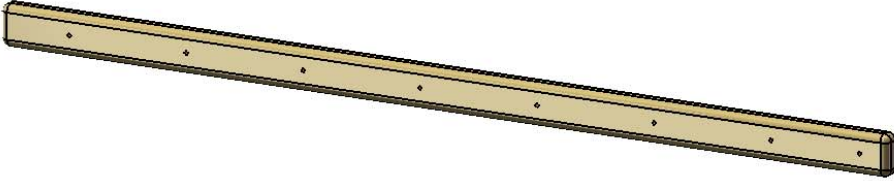
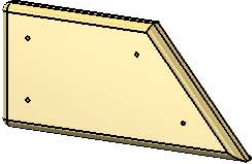
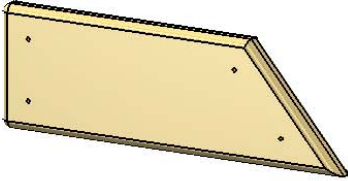
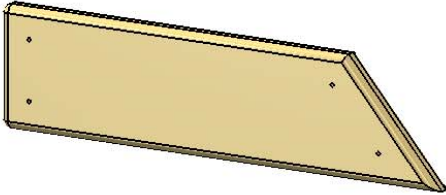
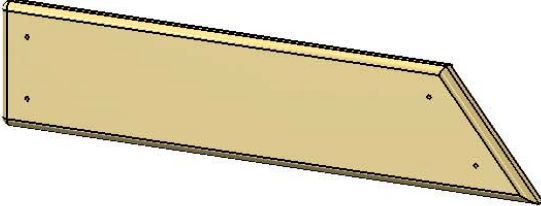
PICTURE	DESCRIPTION	QTY.
	<p>2 X 4 X 70" DECK SUPPORT (2 HOLES ON CENTER) 2-4-7000-DS</p>	<p>2</p>
	<p>2 X 4 X 70" REAR TOP PANEL BOARD (2 HOLES OFFSET/ 1 CENTERED) 2-4-7000-RTPB</p>	<p>1</p>
	<p>2 X 4 X 69-3/4" ROOF FINISHER SUPPORT (2 HOLES ON CENTER) 2-4-6975-RFS</p>	<p>1</p>
	<p>2 X 4 X 70" CENTER DECK SUPPORT 2-4-7000-CDS</p>	<p>2</p>
	<p>2 X 6 X 21¹/₂" END PANEL BOARD (4 HOLES OFFSET) 2-6-2150-EPB</p>	<p>1</p>
	<p>2 X 6 X 47¹/₂" BOTTOM PANEL AND SANDBOX BOARD (4 HOLES OFFSET) 2-6-4750-ESPB</p>	<p>2</p>
	<p>2 X 6 X 70" FRONT FACE BOARD (4 HOLES OFFSET) 2-6-7000-FFB</p>	<p>1</p>

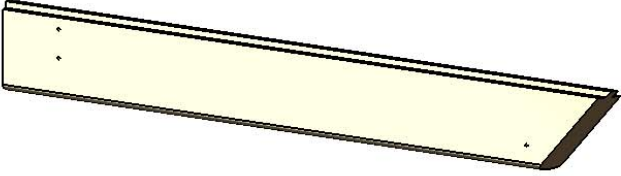
PICTURE	DESCRIPTION	QTY.
	<p>2 X 6 X 70" BOTTOM PANEL AND SANDBOX BOARD (4 HOLES OFFSET) 2-6-7000-SB</p>	<p>2</p>
	<p>2 X 6 X 70" FRONT TOP PANEL BOARD (4 HOLES OFFSET, 1 CENTER) 2-6-7000-FTPB</p>	<p>1</p>
	<p>2 X 6 X 70" REAR FACE BOARD (4 HOLES OFFSET) 2-6-7000-RFB</p>	<p>1</p>
	<p>2 X 6 X 79-1/2" ROPE LADDER SUPPORT (4 HOLES OFFSET, 3 HOLES ON CENTER) 2-6-7950-RLS</p>	<p>1</p>
	<p>2 X 6 X 79-1/2" ROPE LADDER RUNNER(4 HOLES OFFSET, 3 HOLES ON CENTER) 2-6-7950-RLR</p>	<p>1</p>
	<p>4 X 4 X 47¹/₂" SWING BEAM MOUNT 4-4-4750-SBM</p>	<p>1</p>
	<p>5 X 11 X 46.97" ROOF PANEL ASSEMBLY 5-11-4697-RPLA 5-11-4697-RPRA</p>	<p>1 LEFT 1 RIGHT</p>

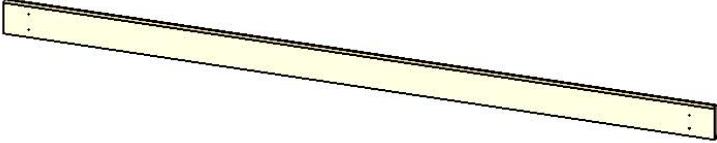
PICTURE	DESCRIPTION	QTY.
	$\frac{5}{4} \times 2\frac{5}{8} \times 13\frac{1}{4}$ PICNIC TABLE SLAT 125-3-1325-PTS	2
	$\frac{5}{4} \times 2\frac{5}{8} \times 17\frac{1}{2}$ TIC TAC TOE MOUNT 125-3-1750-TTMM	2
	$\frac{5}{4} \times 2\frac{5}{8} \times 28\frac{1}{4}$ PANEL SLAT 125-3-2825-PS	15
	$\frac{5}{4} \times 2\frac{5}{8} \times 33$ PANEL SLAT 125-3-3300-PS	2
	$\frac{5}{4} \times 4 \times 14\frac{1}{2}$ DECK SPACER 125-4-1450-DS	1
	$\frac{5}{4} \times 4 \times 22\frac{1}{2}$ DECK SPACER 125-4-2250-DS	1
	$\frac{5}{4} \times 3 \times 18\frac{3}{4}$ LADDER BACK 125-3-1875-LB	1

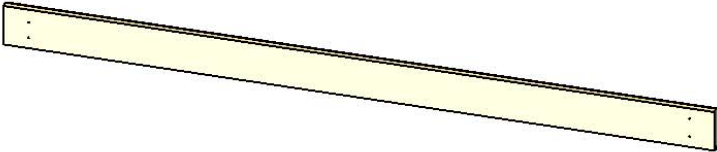
PICTURE	DESCRIPTION	QTY.
	$\frac{5}{4} \times 3 \times 23\frac{7}{8}$ ROCK WALL CAP 125-3-2387-RWC	1
	$\frac{5}{4} \times 4 \times 40\frac{3}{8}$ DECK SPACER 125-4-4038-DS	2
	$\frac{5}{4} \times 6 \times 10$ " ROOF PEAK SUPPORT 125-6-1000-RPS	2
	$\frac{5}{4} \times 5 \times 10.81$ " ROOF PANEL PEAK SUPPORT 125-5-1081-RPPS	1
	$\frac{5}{4} \times 6 \times 22$ " SANDBOX SEAT 125-6-2200-SS	2
	$\frac{5}{4} \times 6 \times 23\frac{7}{8}$ BOTTOM ROCK WALL BOARD 125-6-2387-BRW	1
	$\frac{5}{4} \times 6 \times 23\frac{7}{8}$ ROCK WALL BOARD 125-6-2387-RWB	11

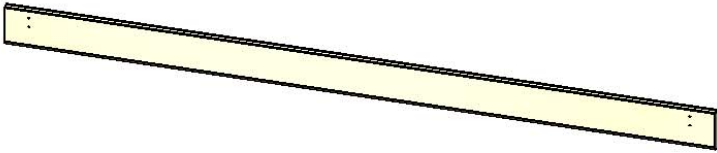
PICTURE	DESCRIPTION	QTY.
	$\frac{5}{4}$ X 6 X 43" PICNIC TABLE TOP AND SEATS 125-6-4300-PTTS	4
	$\frac{5}{4}$ X 6 X 47 $\frac{3}{8}$ " DECK BOARD 125-6-4737-DB	11
	1 X 2 X 32" ROOF BATTEN 1-2-3200-RB	2
	1 X 4 X 8-3/4" WALL PANEL BOARD 1-4-0875-WPB	2
	1 X 4 X 12-1/4" WALL PANEL BOARD 1-4-1225-WPB	2
	1 X 4 X 15-3/4" WALL PANEL BOARD 1-4-1575-WPB	2
	1 X 4 X 19-5/16" WALL PANEL BOARD 1-4-1931-WPB	2

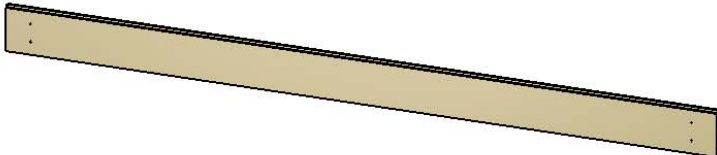
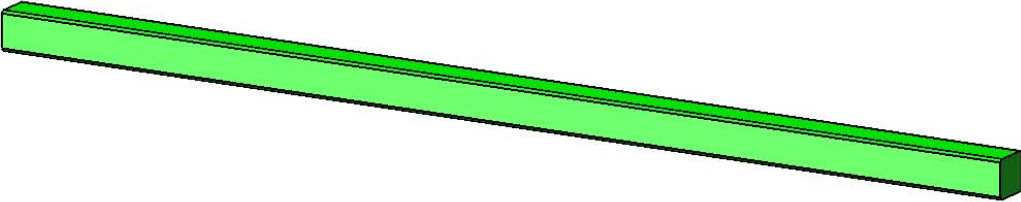
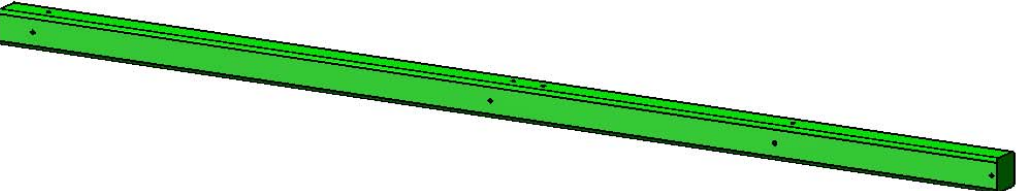
	PICTURE	DESCRIPTION	QTY.
		1 X 4 X 29.29" TONGUE-ONLY ROOF FINISHER FRONT 1-4-2929-RFF	1 LEFT 1 RIGHT
		1 X 4 X 76-7/8" GROOVE-ONLY ROOF STARTER REAR 1-4-7688-RSR	1
		1 X 4 X 76-7/8" GROOVE-ONLY ROOF STARTER FRONT 1-4-7688-RSF	1
		1 X 4 X 76-7/8" TONGUE-ONLY ROOF FINISHER REAR 1-4-7688-RFR	1
		1 X 5 X 76-7/8" TONGUE-AND- GROOVE ROOF BOARD 1-5-7688-RB	14
	PLASTIC COATED 4 X 4 X 108" SWING BEAM LEG SL-1	2	
	PLASTIC COATED 4 X 4 X 108" CORNER POST	4	

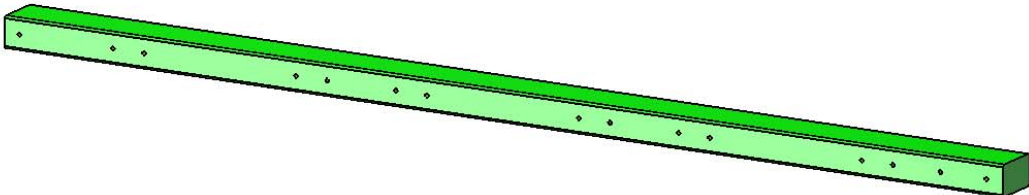
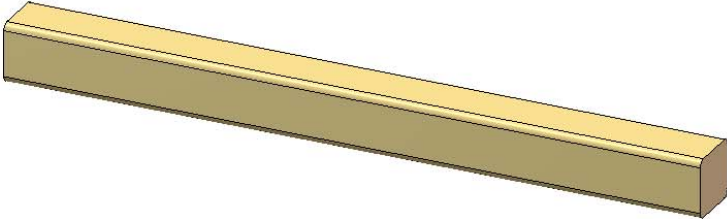
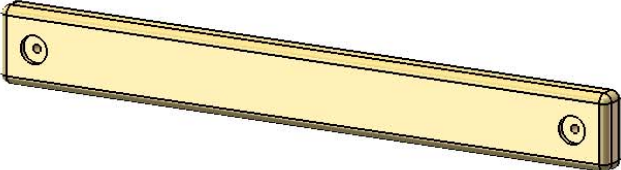
PICTURE	DESCRIPTION	QTY.
	PLASTIC COATED 4 X 6 X 120" SWING BEAM SB-3-0	1
	4 X 4 X 40" END WALL SLIDE MOUNT 4-4-4000-EWSM	1
	2 X 4 X 29-1/4" SLIDE HEADER BOARD 2-4-2925-SHB	1

COUNT AND ORGANIZE YOUR LUMBER INTO LIKE STACKS (2 X 4, 2 X 6, 4 X 4, 4 X 6, ETC.). THIS WILL HELP IN IDENTIFYING COMPONENTS AND REDUCE YOUR BUILDING TIME

PICTURE

DESCRIPTION

QTY.

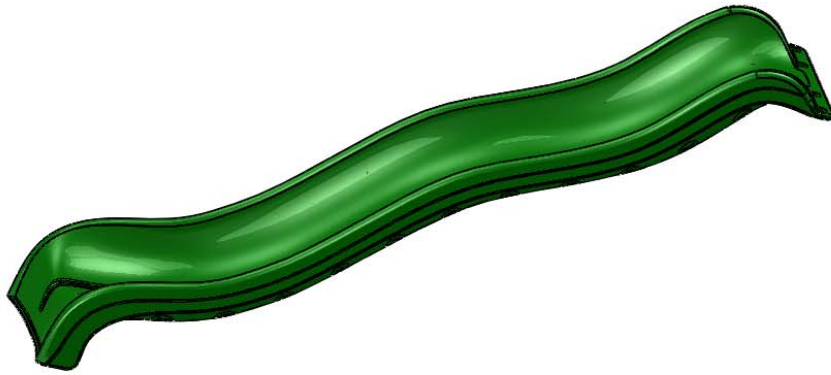

WAVE
SLIDE
03-0013

1

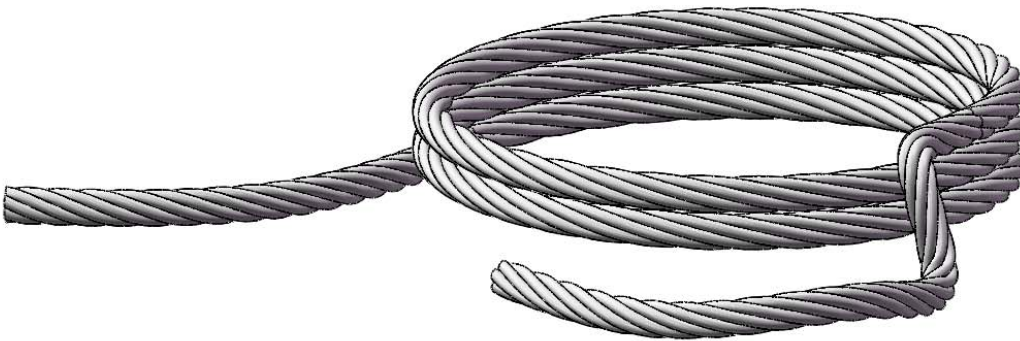

13'
ROPE
LADDER
ROPES

3



SWINGS
W/CHAINS
04-0002

2



TRAPEZE
BAR
W/CHAINS
04-0006

1

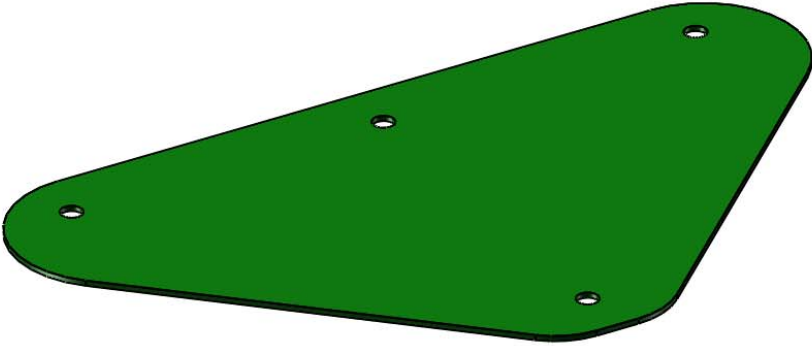
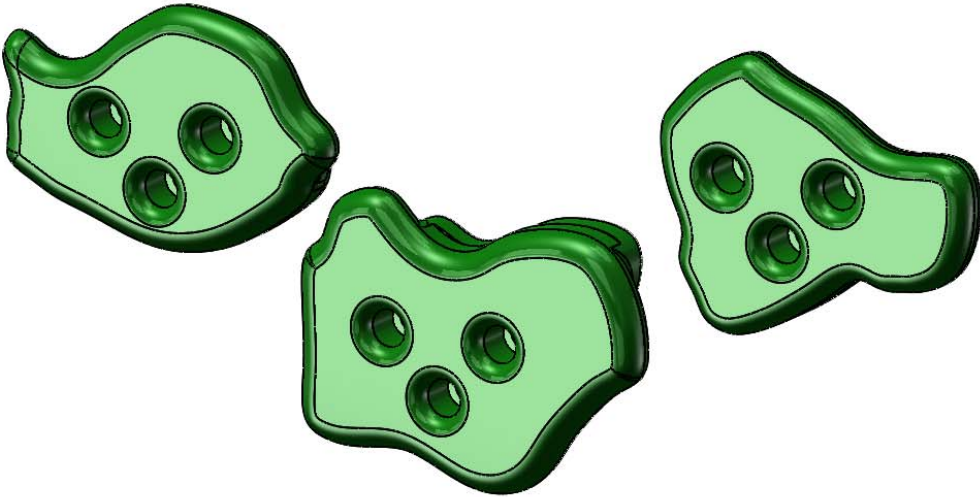
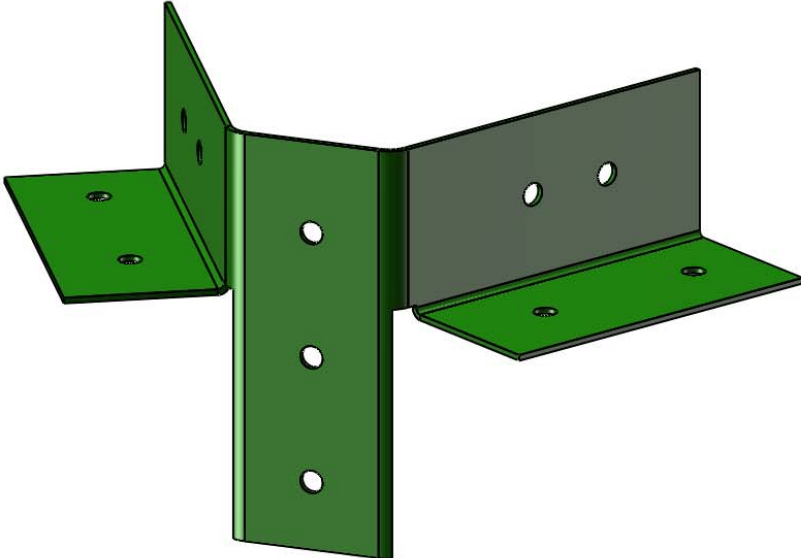
PICTURE	DESCRIPTION	QTY.
	<p>SWING PLATE 11-5002</p>	<p>1</p>
	<p>CLIMBING ROCKS (07-0008 IS A PACK OF 5)</p>	<p>10 ROCKS</p>
	<p>A-FRAME SWING LEG BRACKET 11-5010</p>	<p>1</p>
<p>HARDWARE BOXES: 1501,1512,1528</p>	<p>HARDWARE BOXES</p>	<p>1 EA.</p>

PICTURE

DESCRIPTION

QTY.

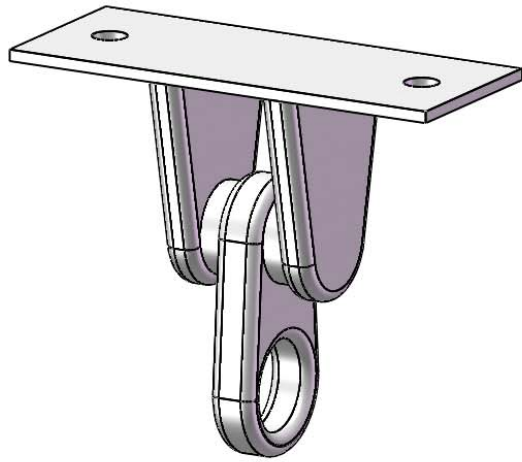

IRON
DUCTILE
SWING
HANGERS
11-4012

6

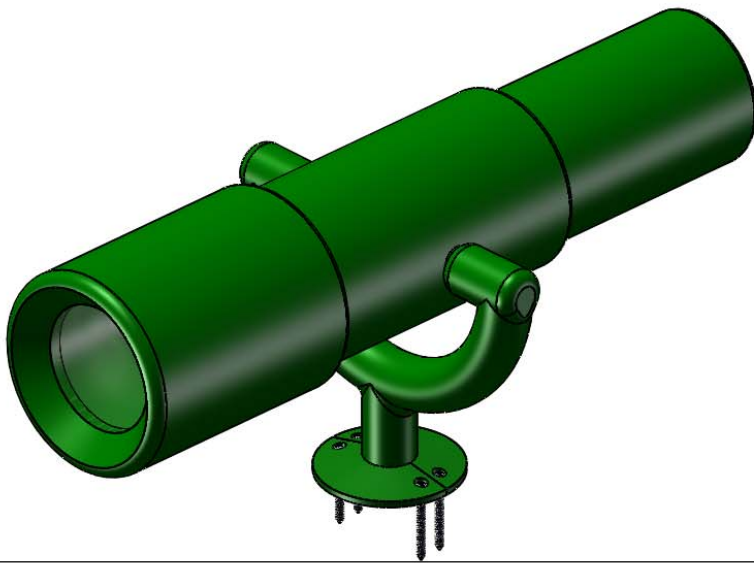

TELESCOPE
07-0001

1

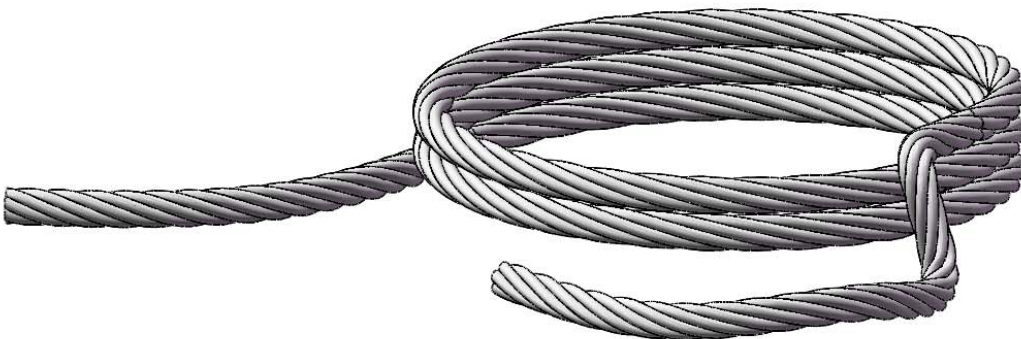

10'
ROCK
WALL
ROPE

1

PICTURE

DESCRIPTION

QTY.

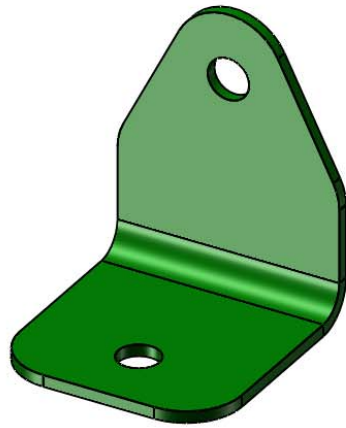

90° GREEN
BRACKET
11-5013

4

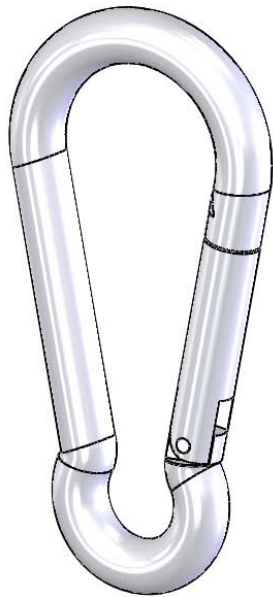



SPRING
CLIP
11-4003

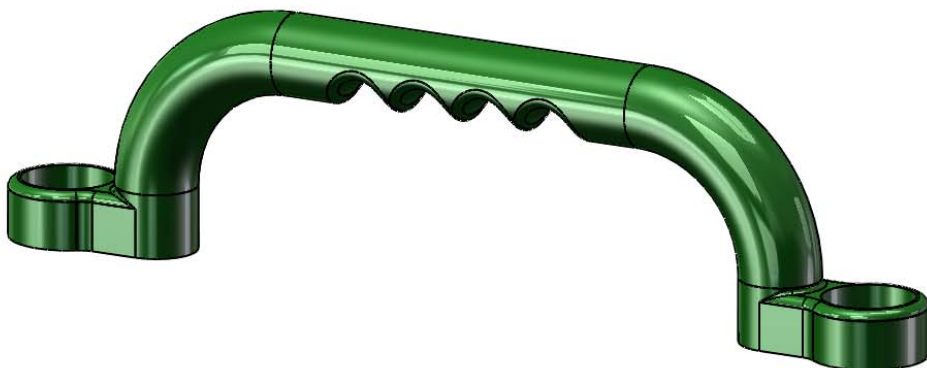



6

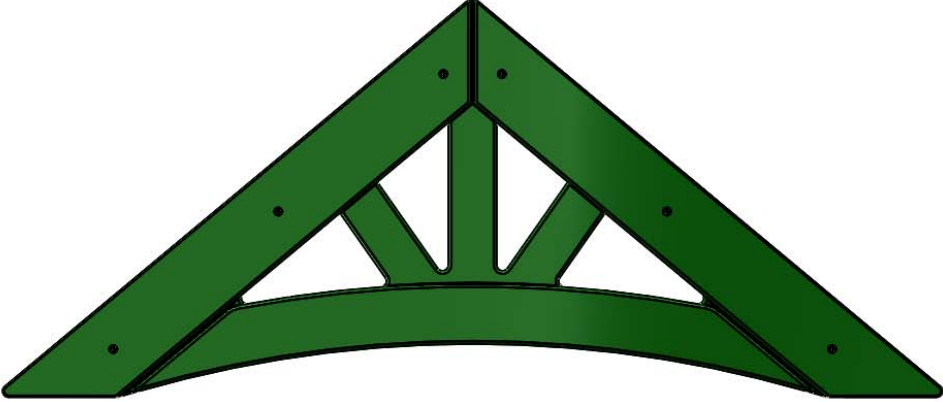
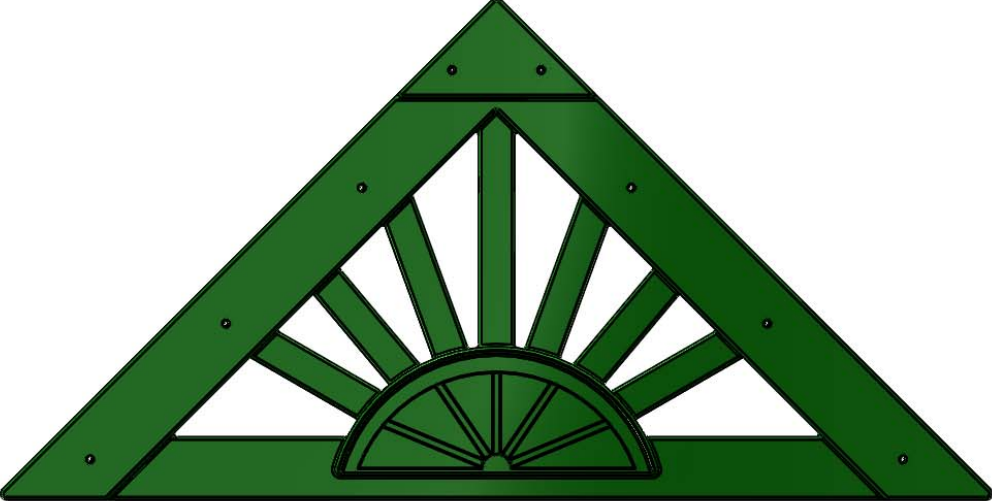
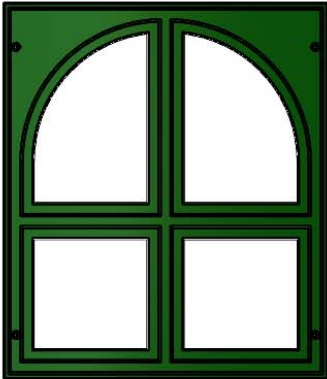

SAFETY
HANDLES
(PAIR)
07-0005

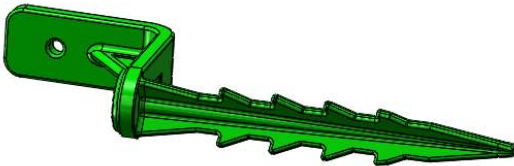
1 pr

PICTURE	DESCRIPTION	QTY.
	<p>FRONT PLASTIC ARCH 07-0027-G</p>	<p>1</p>
	<p>PLASTIC SUNBURST 07-0028-G</p>	<p>2</p>
	<p>DORMER WINDOW 07-0029-G</p>	<p>2</p>
	<p>SOLAR WALL LIGHT 09-2003</p>	<p>2</p>

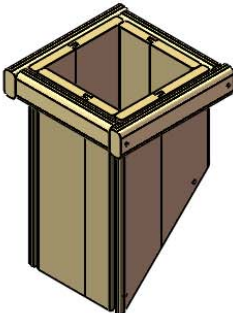
PICTURE	DESCRIPTION	QTY.
(NOT SHOWN)	MANUFACTURER LOGO PLATE	1
	GROUND STAKE (PAIR) 07-0016-P	1 pr
	TIC TAC TOE (UNASSEMBLED) 07-0010	1
	STEERING WHEEL 07-0004	1
	UNASSEMBLED DORMER (1529 BOX)	2
	UNASSEMBLED CHIMNEY (1529 BOX OR SLIDE BOX)	1

PICTURE

DESCRIPTION

QTY.

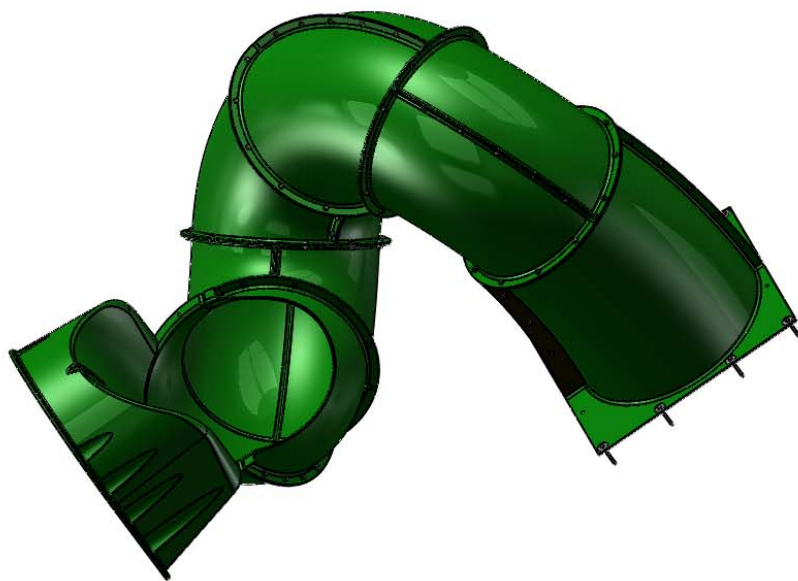

EXTREME
TUBE SLIDE
03-0014

1

STEP 1: ATTACHING T-NUTS TO THE CORNER POSTS

- 1: THIS STEP IS CRITICAL TO BUILDING THE FORT PROPERLY. IF ANY MISTAKES ARE MADE HERE, YOU WILL NEED TO DIS-ASSEMBLE AND THEN RE-ASSEMBLE TO MAKE YOUR CORRECTIONS.
- 2: MAKE SURE HOLES ARE FREE OF ANY OBSTRUCTIONS. USE A BOLT TO CLEAN OUT ANY DEBRIS.
- 3: LAY OUT EACH OF THE 4 X 4 X 108" CORNER POSTS IN THE AREA YOU INTEND ON BUILDING THE FORT SIDE OF THE PLAYSET.
- 4: USE THE DIAGRAM BELOW TO CORRECTLY IDENTIFY AND ORIENT THE DIRECTION THE POSTS SHOULD FACE.
- 5: USE A HAMMER TO SEAT THE T-NUTS AFTER INSERTING THEM INTO THE HOLES SHOWN IN THE DIAGRAM BELOW.
- 6: THE BARREL OF THE T-NUT SHOULD GO IN THE HOLE FIRST. HAMMER THE T-NUT UNTIL IT IS FLUSH/ALMOST FLUSH TO THE CORNER POSTS.

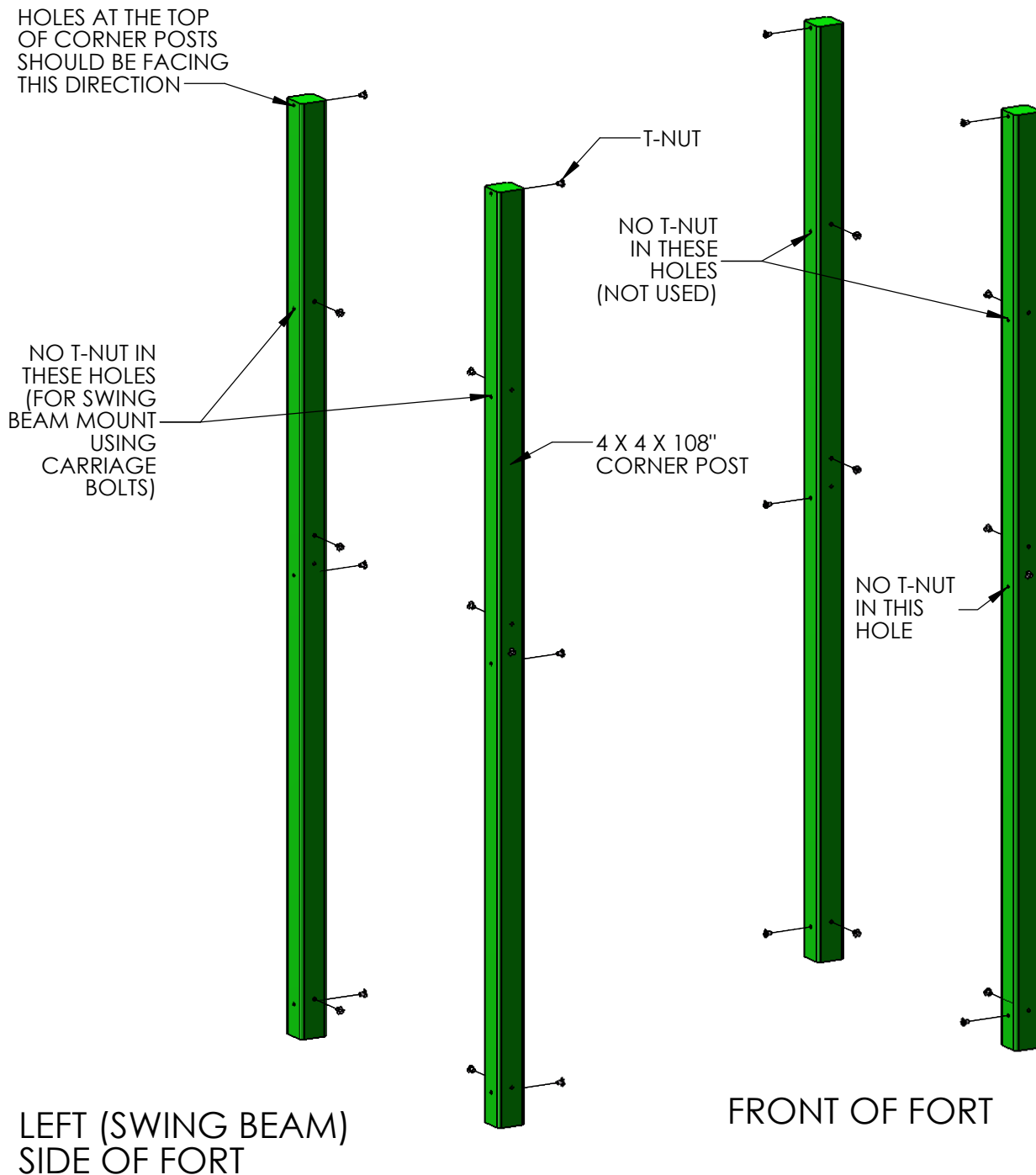

STEP 2: ASSEMBLING THE RIGHT SIDE FRAME

1: LAY THE 2 X 6 X 79-1/2" ROPE LADDER RUNNER ON TOP OF THE RIGHT SIDE CORNER POSTS AT THE BOTTOM OF THE CORNER POSTS. THE HOLES IN THE ROPE LADDER RUNNER MUST BE OFFSET DOWN.

2: USE 5/16 X 4-1/2" HEX BOLTS AND 5/16" WASHERS TO ATTACH THE TOP HOLES OF THE ROPE LADDER RUNNER TO THE T-NUTS INSTALLED ON THE CORNER POSTS. THE BOTTOM HOLES WILL BE USED LATER.

3: LAY THE 2 X 6 X 79-1/2" ROPE LADDER SUPPORT ON TOP OF THE RIGHT SIDE CORNER POSTS, AND MEASURE 14" FROM THE TOP OF BOTH CORNER POSTS.

4: BEFORE INSTALLING LAG SCREWS, MEASURE THE DISTANCE ACROSS THE OUTSIDE OF THE BOTTOM OF THE CORNER POSTS AND THEN MAKE THE OUTSIDE TOP OF THE CORNER POSTS EQUAL TO THAT MEASUREMENT. USE 5/16 X 3-1/2" LAG SCREWS AND 5/16" WASHERS TO ATTACH THE TOP HOLES OF THE ROPE LADDER SUPPORT TO THE CORNER POSTS. THE BOTTOM HOLES WILL BE USED LATER.

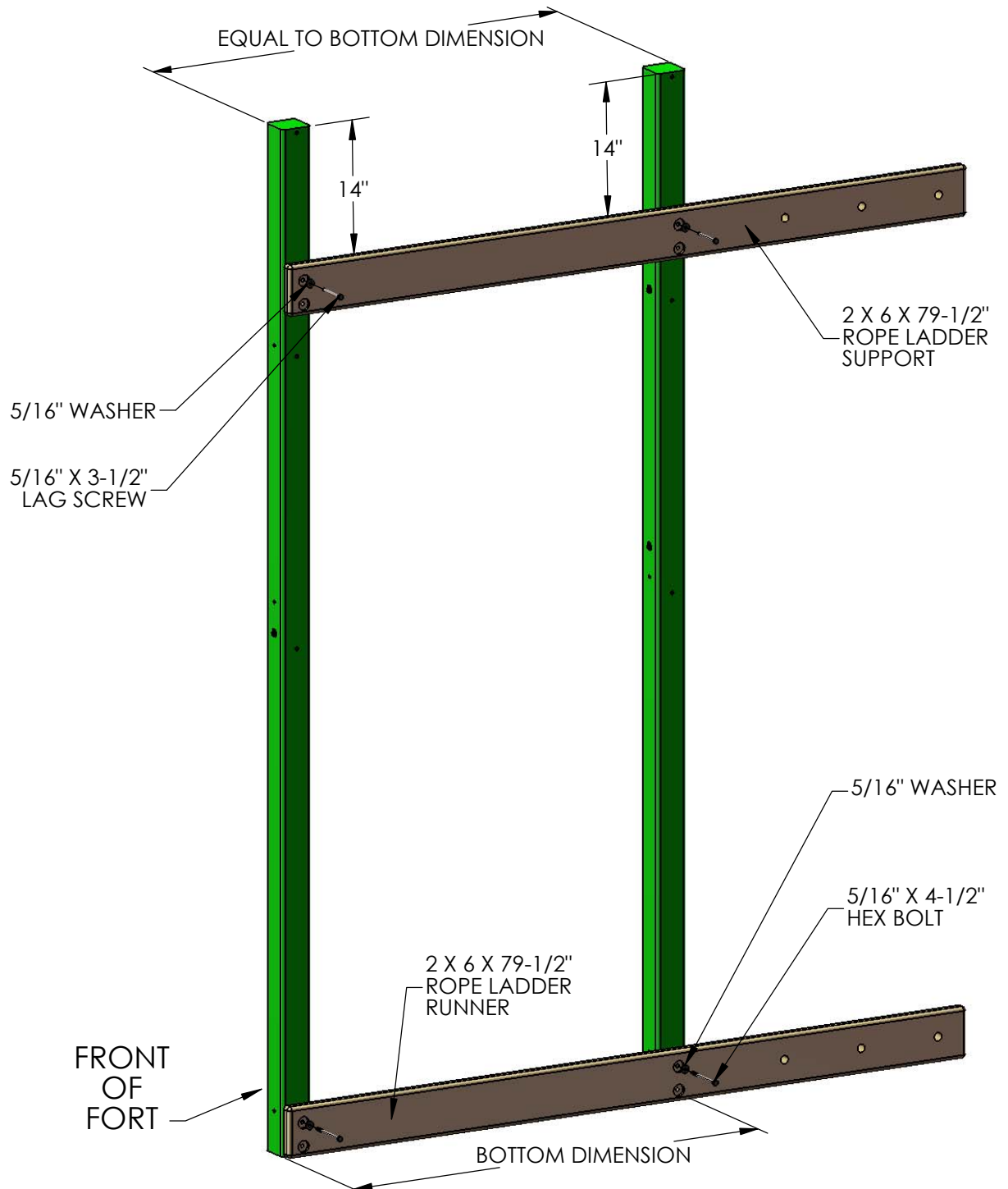

STEP 3: ASSEMBLING THE LEFT SIDE FRAME

- 1: LAY THE 2 X 6 X 47-1/2" SANDBOX BOARD ON TOP OF THE LEFT SIDE CORNER POSTS AT THE BOTTOM OF THE CORNER POSTS. THE HOLES IN THE SANDBOX BOARD MUST BE OFFSET DOWN.
- 2: USE 5/16 X 4-1/2" HEX BOLTS AND 5/16" WASHERS TO ATTACH THE TOP HOLES OF THE SANDBOX BOARD TO THE T-NUTS INSTALLED ON THE CORNER POSTS. THE BOTTOM HOLES WILL BE USED LATER.
- 3: LAY THE 2 X 6 X 47-1/2" BOTTOM PANEL BOARD ON TOP OF THE LEFT SIDE CORNER POSTS IN THE MIDDLE OF THE CORNER POSTS. THE OFFSET HOLES IN THE BOTTOM PANEL BOARD MUST BE OFFSET DOWN.
- 4: USE 5/16 X 4-1/2" HEX BOLTS AND 5/16" WASHERS TO ATTACH THE BOTTOM HOLES OF THE BOTTOM PANEL BOARD TO THE T-NUTS INSTALLED ON THE CORNER POSTS. THE TOP HOLES WILL BE USED LATER.
- 5: LAY THE 4 X 4 X 47-1/2" SWING BEAM SUPPORT ON TOP OF THE LEFT SIDE CORNER POSTS. THE THREE COUNTERSUNK HOLES IN THE MIDDLE OF THE SWING BEAM SUPPORT MUST FACE DOWNWARD.
- 6: FIND TWO TORQUE WASHERS. PLACE A 3/8" X 6-1/2" CARRIAGE BOLT INSIDE THE TORQUE WASHER, MAKING SURE THAT THE TEETH ARE FACING IN THE SAME DIRECTION AS THE THREADS OF THE CARRIAGE BOLT. PLACE THE TORQUE WASHER/CARRIAGE BOLT ASSEMBLY INTO THE HOLES OF THE CORNER POST SO THAT THE HEAD OF THE CARRIAGE BOLT FACES WHAT WILL BE THE INSIDE OF THE FORT. USE A HAMMER TO SET THE TORQUE WASHER INTO THE CORNER POST.
- 7: ATTACH THE SWING BEAM SUPPORT AS SHOWN IN DETAIL A.

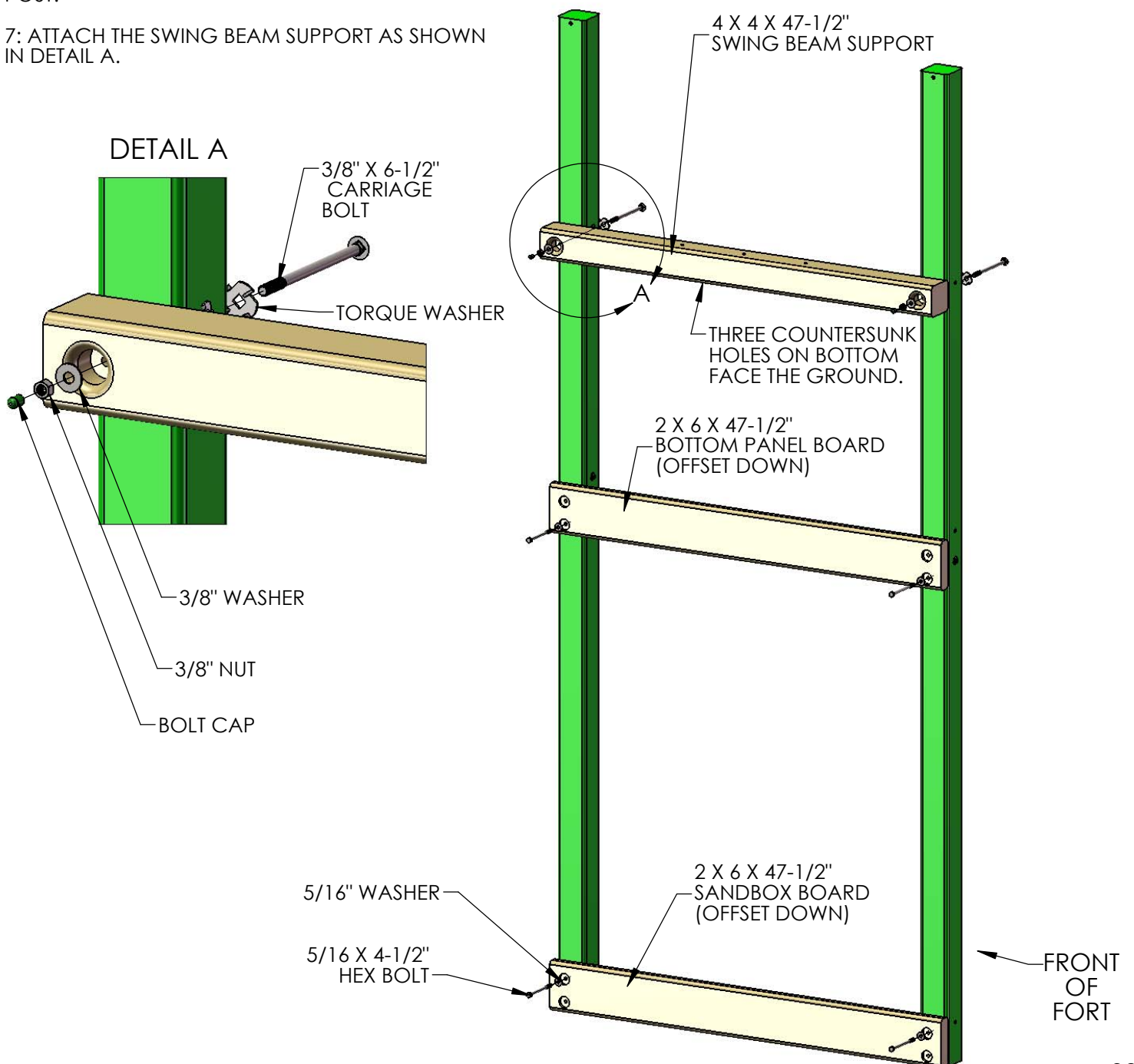

STEP 4: DECK SUPPORTS

YOU WILL NEED AN EXTRA PERSON FOR THIS STEP.

1: WITH HELP, STAND UP THE LEFT AND RIGHT SIDE ASSEMBLIES.

2: FASTEN THE 2 X 4 X 70" DECK SUPPORTS TO THE HOLES AT 54-3/4" WITH 5/16 X 4-1/2" HEX BOLTS AND 5/16" WASHERS FROM THE INSIDE OF THE FORT.

3: HAVE AN ASSISTANT HOLD UP THE LEFT OR RIGHT SIDE FRAME WHILE YOU ATTACH THE BOARDS IN STEPS 5 AND 6 SO THAT THE STRUCTURE REMAINS STABLE DURING ASSEMBLY.

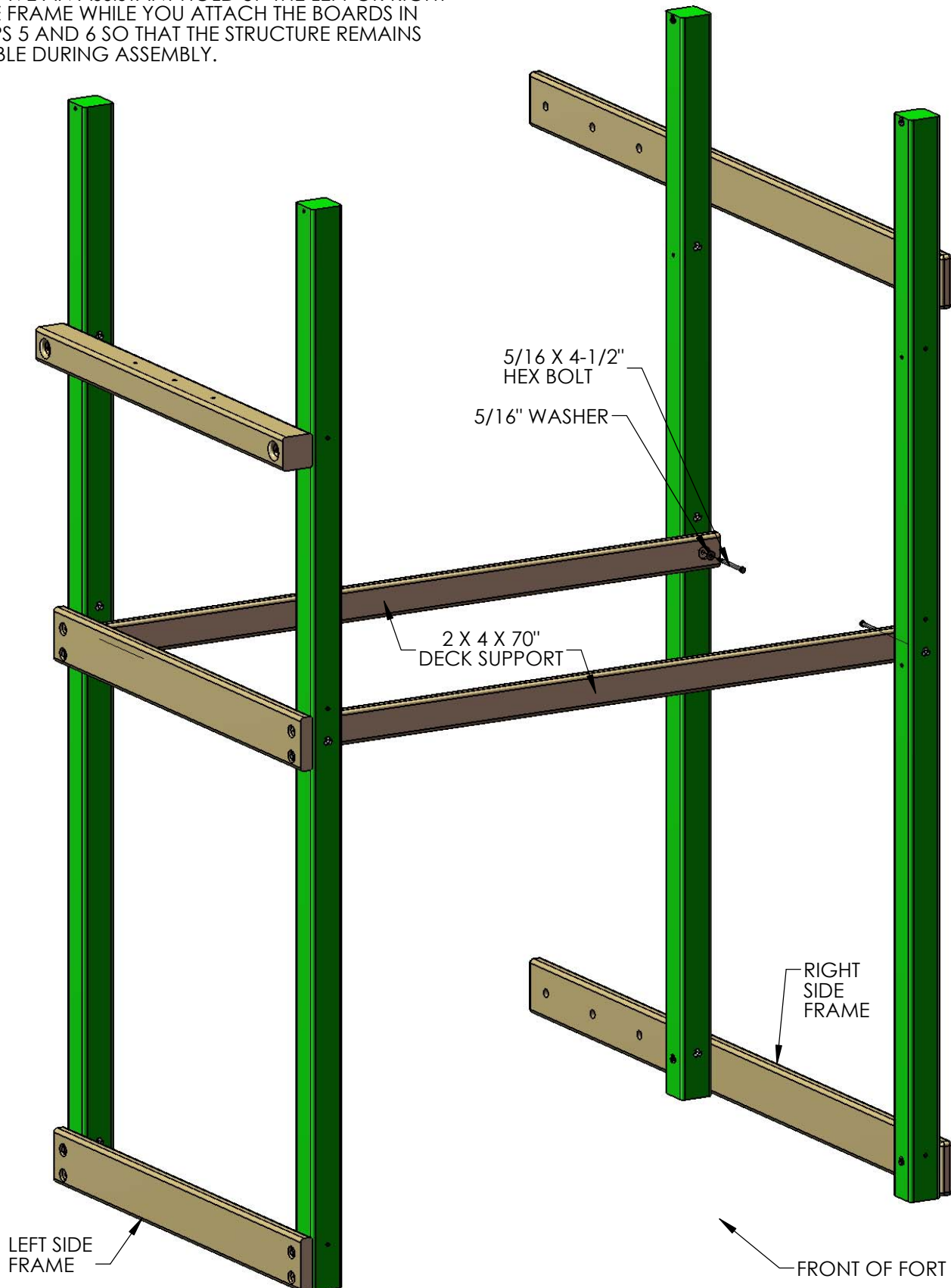

STEP 5: FRONT FRAME ASSEMBLY

- 1: PLACE THE 2 X 6 X 70" SANDBOX BOARD ON THE FRONT OF THE CORNER POSTS AT THE BOTTOM. THE HOLES IN THE SANDBOX BOARD MUST BE OFFSET UP.
- 2: USE 5/16 X 4-1/2" HEX BOLTS AND 5/16" WASHERS TO ATTACH THE TOP HOLES OF THE SANDBOX BOARD TO THE T-NUTS INSTALLED ON THE CORNER POSTS. THE BOTTOM HOLES WILL BE USED LATER.
- 3: PLACE THE 2 X 6 X 70" FRONT FACE BOARD WITH NOTCHES ON THE FRONT OF THE CORNER POSTS AT THE MIDDLE. THE HOLES IN THE FRONT FACE BOARD MUST BE OFFSET UP.
- 4: USE 5/16 X 4-1/2" HEX BOLTS AND 5/16" WASHERS TO ATTACH THE TOP HOLES OF THE FRONT FACE BOARD TO THE T-NUTS INSTALLED ON THE CORNER POSTS. THE BOTTOM HOLES WILL BE USED LATER.
- 5: PLACE THE 2 X 6 X 70" FRONT TOP PANEL BOARD ON THE FRONT OF THE CORNER POSTS DOWN FROM THE TOP AS SHOWN. THE HOLES IN THE TOP PANEL BOARD MUST BE OFFSET UP.
- 6: USE 5/16 X 4-1/2" HEX BOLTS AND 5/16" WASHERS TO ATTACH THE TOP HOLES OF THE FRONT TOP PANEL BOARD TO THE T-NUTS INSTALLED ON THE CORNER POSTS.

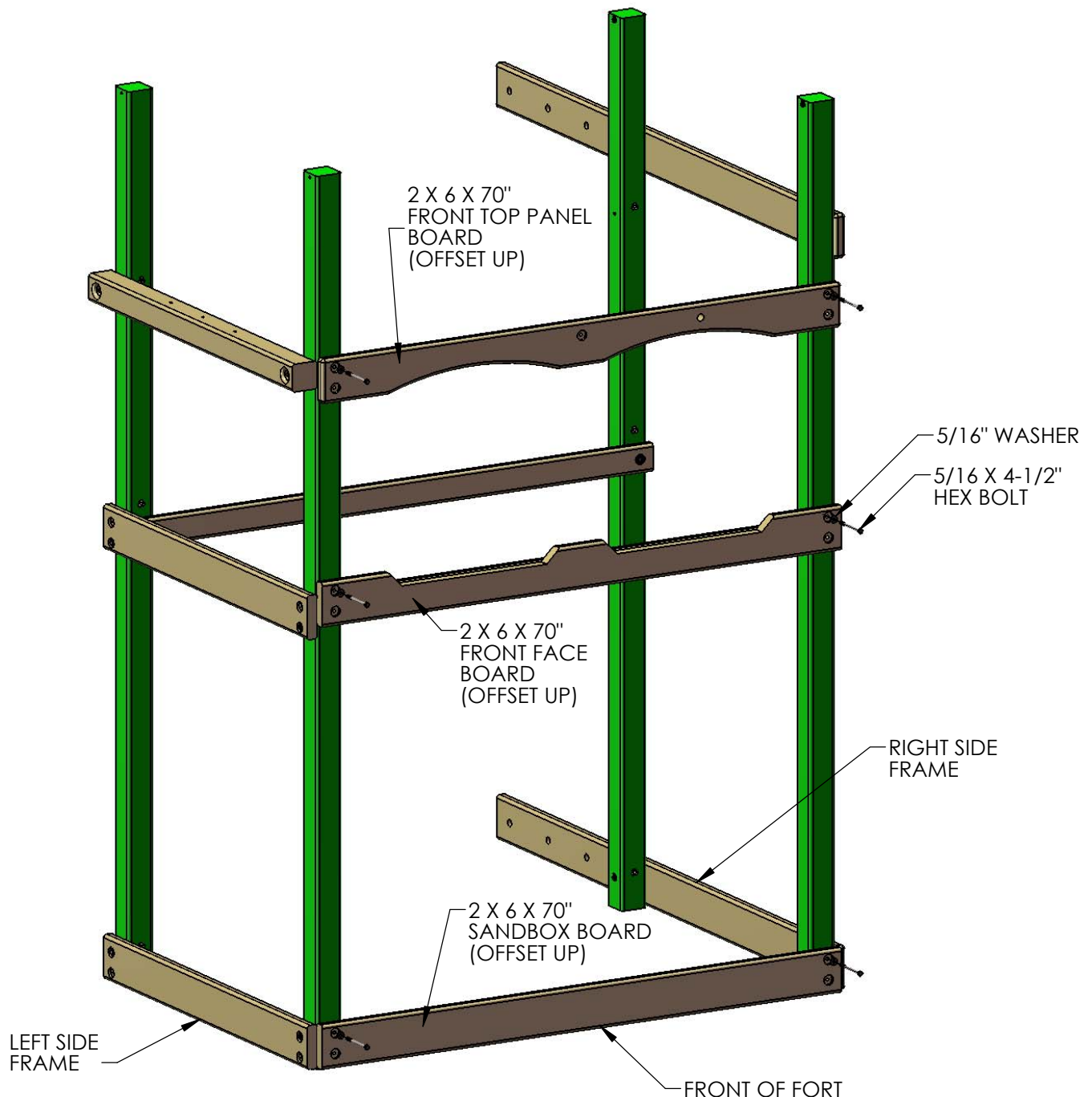

STEP 6: REAR FRAME ASSEMBLY

- 1: PLACE THE 2 X 6 X 70" SANDBOX BOARD ON THE REAR OF THE CORNER POSTS. THE HOLES IN THE SANDBOX BOARD MUST BE OFFSET UP.
- 2: USE 5/16 X 4-1/2" HEX BOLTS AND 5/16" WASHERS TO ATTACH THE TOP HOLES OF THE SANDBOX BOARD TO THE T-NUTS INSTALLED ON THE CORNER POSTS. THE BOTTOM HOLES WILL BE USED LATER.
- 3: PLACE THE 2 X 6 X 70" REAR FACE BOARD ON THE REAR OF THE CORNER POSTS. THE HOLES IN THE REAR FACE BOARD MUST BE OFFSET UP.
- 4: USE 5/16 X 4-1/2" HEX BOLTS AND 5/16" WASHERS TO ATTACH THE TOP HOLES OF THE REAR FACE BOARD TO THE T-NUTS INSTALLED ON THE CORNER POSTS. THE BOTTOM HOLES WILL BE USED LATER.
- 5: PLACE THE 2 X 4 X 70" REAR TOP PANEL BOARD ON THE REAR OF THE CORNER POSTS. THE HOLES IN THE REAR TOP PANEL BOARD MUST BE OFFSET UP.
- 6: USE 5/16 X 4-1/2" HEX BOLTS AND 5/16" WASHERS TO ATTACH THE TOP HOLES OF THE REAR TOP PANEL BOARD TO THE T-NUTS INSTALLED ON THE CORNER POSTS.

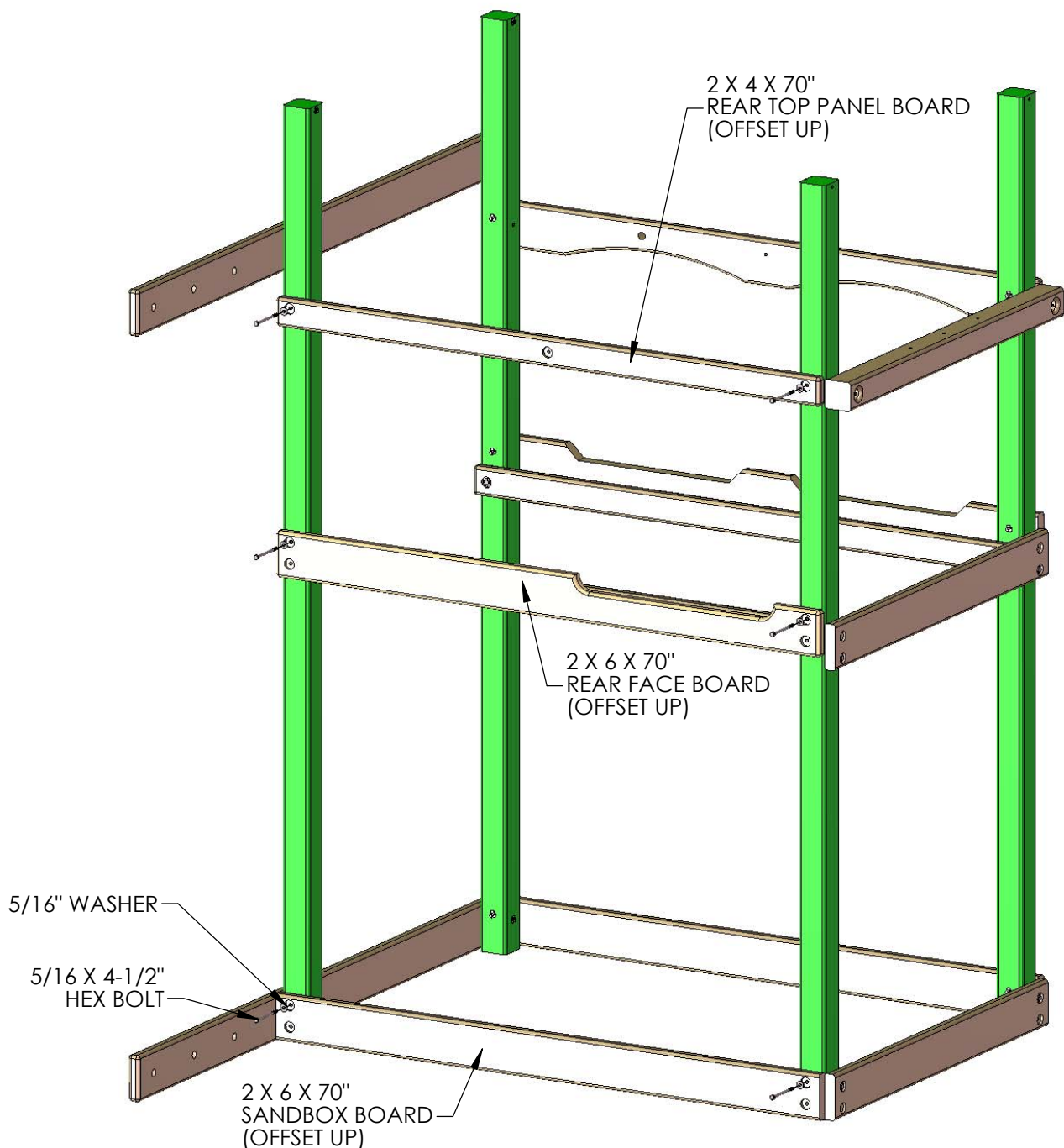

STEP 6A: LEVELING THE PLAY SET AND LAGS

1: INSTALL LAG SCREWS ONLY IN THE THREE 2 X 6 BOARDS AT DECK HEIGHT AND THE ROPE LADDER SUPPORT AT THIS TIME. SQUARE EACH OF THESE THREE BOARDS TO THE POSTS AND THEN INSTALL THE LAG SCREWS. THIS IS TO MAKE THE STRUCTURE RIGID FOR THE LEVELING AND SQUARING PROCESS.

2: PLACE THE FRAME IN ITS FINAL POSITION AND FOLLOW THE PROCEDURES AT THE FRONT OF THE MANUAL TO LEVEL AND SQUARE THE STRUCTURE. HAVE AN ASSISTANT HELP YOU LIFT THE FRAME AS REQUIRED. **DO NOT** INSTALL REMAINING LAG SCREWS UNTIL AFTER THE FRAME HAS BEEN LEVELED AND SQUARED.

3: ONCE THE FRAME IS LEVEL, SQUARE AND SET INTO POSITION; GO BACK AND INSERT THE 5/16" X 3-1/2" LAG SCREWS AND 5/16" WASHERS IN ALL THE REMAINING HOLES OF THE 2 X 6 PARTS ON THE FRONT, SIDES AND REAR OF THE PLAY SET. NOTE: THERE WILL NOT BE ANY PREDRILLED HOLES IN THE CORNER POSTS FOR THE LAG SCREWS.

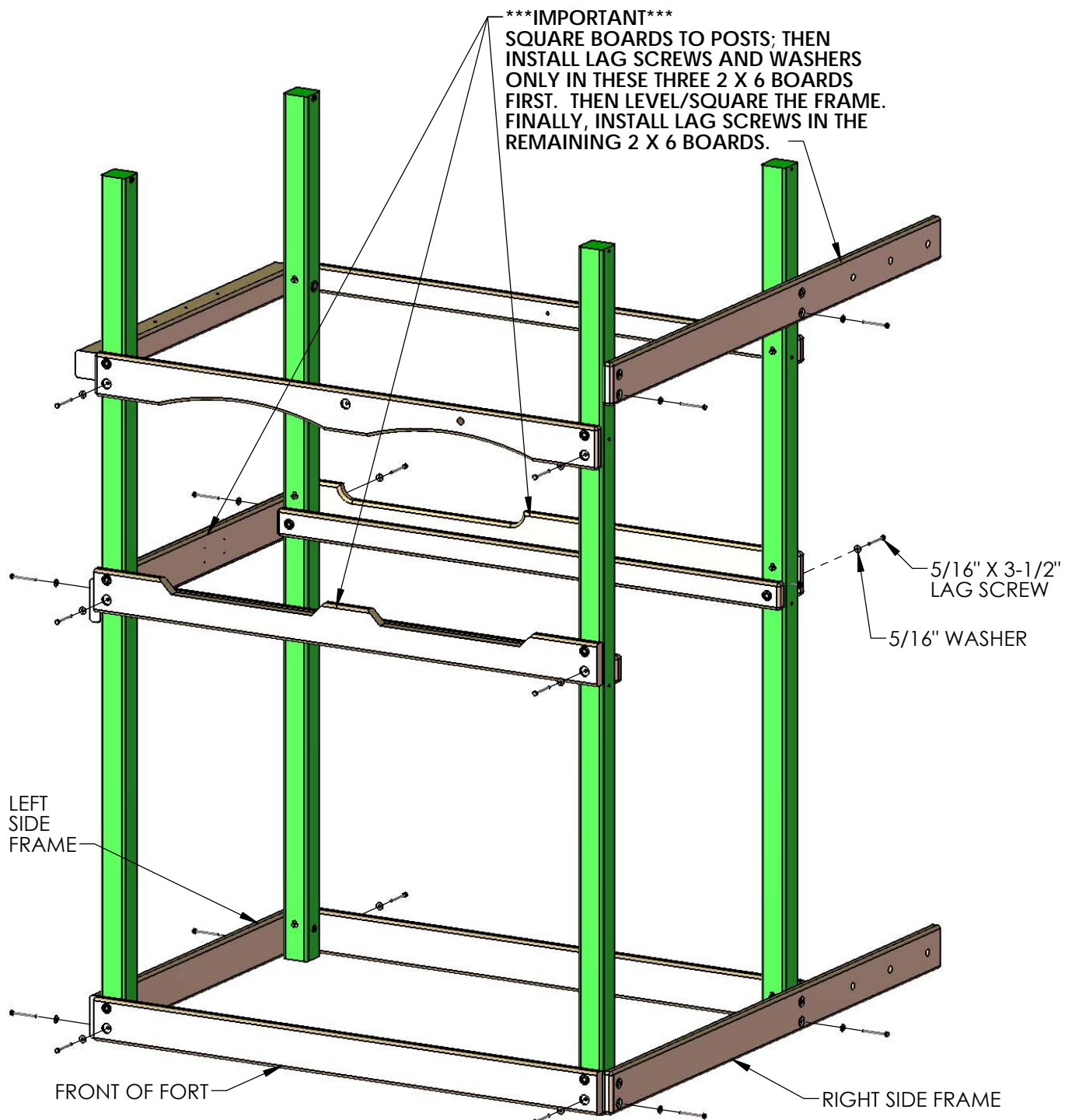

STEP 6B: ANGLE SUPPORTS

1: TWO 2 X 4 X 18" ANGLE SUPPORTS ARE MOUNTED UNDER THE DECK ON THE LEFT SIDE OF THE PLAY SET TO THE 2 X 6 BOTTOM PANEL BOARD. **THE TOP OF THE ANGLE SUPPORT SHOULD BE FLUSH OR LOWER THAN THE TOP OF THE DECK SUPPORT.**

2: AT THE TOP USE 2-1/2" WOOD SCREWS THROUGH THE ANGLE SUPPORT INTO THE BOTTOM PANEL BOARD. AT THE BOTTOM USE ONE 2" AND ONE 3" WOOD SCREW TO FASTEN THE ANGLE SUPPORT TO THE CORNER POST.

3: FOUR 2 X 4 X 13" ANGLE SUPPORTS ARE MOUNTED UNDER THE DECK ON THE FRONT AND REAR OF THE PLAY SET TO THE 2 X 4 DECK SUPPORTS. **THE TOP OF THE ANGLE SUPPORT SHOULD BE FLUSH OR LOWER THAN THE TOP OF THE DECK SUPPORT.**

4: AT THE TOP USE 2-1/2" WOOD SCREWS THROUGH THE DECK SUPPORT INTO THE ANGLE SUPPORT. AT THE BOTTOM USE ONE 2" AND ONE 3" WOOD SCREW TO FASTEN THE ANGLE SUPPORT TO THE CORNER POST.

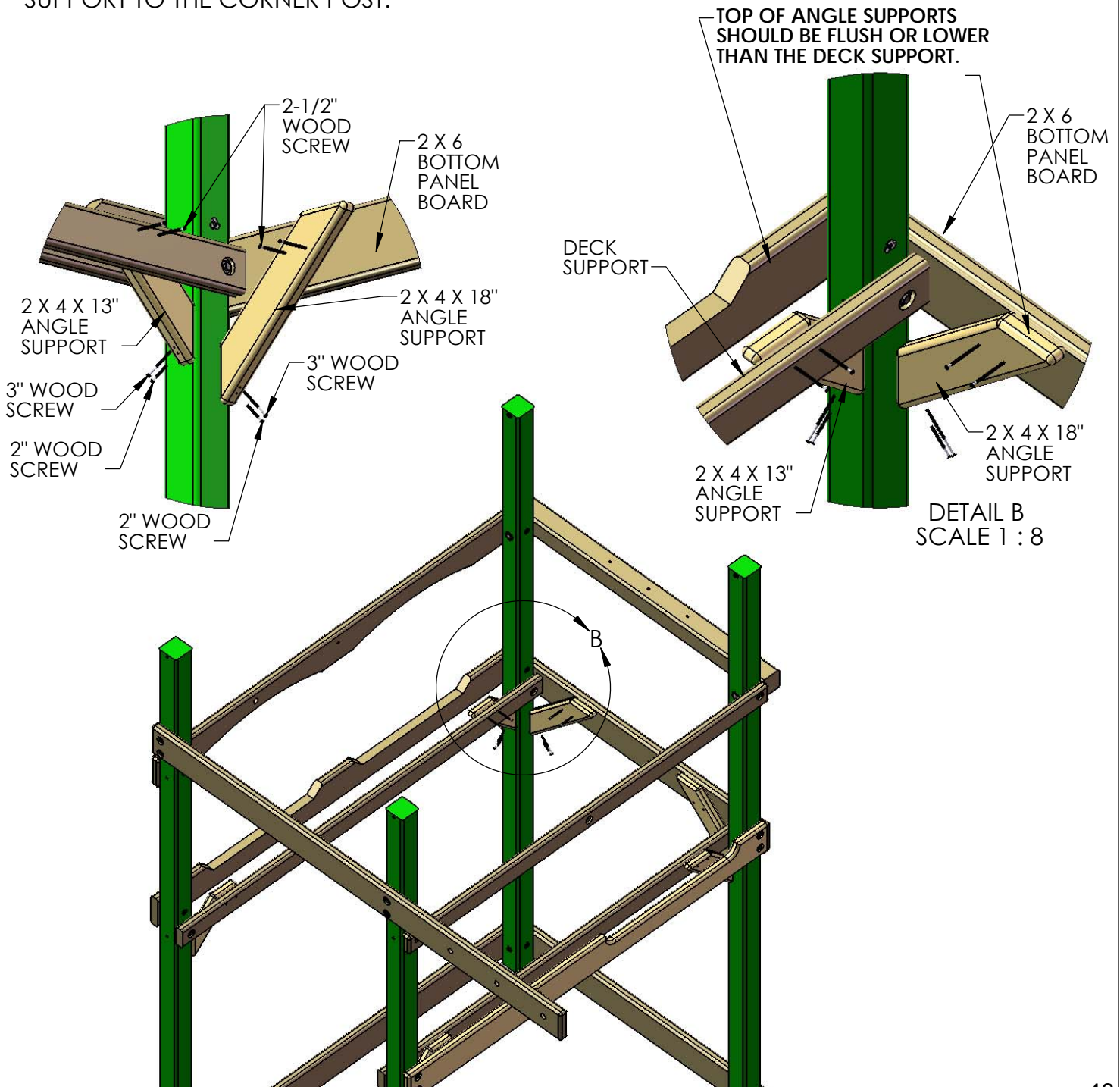

STEP 7: BOTTOM PANEL BOARD

1: PLACE THE 2 X 4 X 47-1/2" PANEL BOARD ON TOP OF THE 2 X 6 PANEL BOARD WITH OFFSET HOLES UP AND FASTEN TO THE CORNER POSTS WITH 5/16 X 3-1/2" LAG SCREWS WITH 5/16" WASHERS.

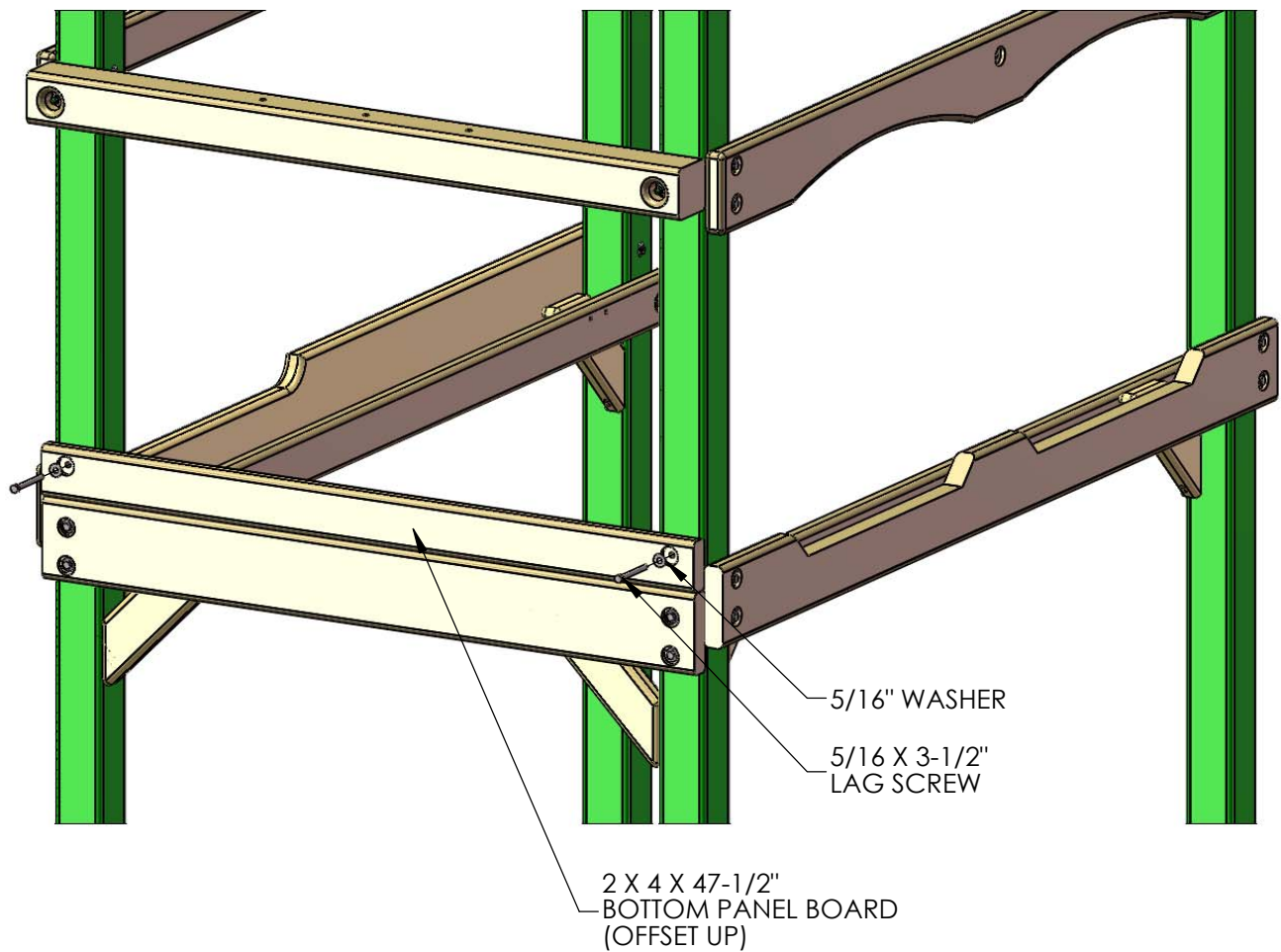

! ATTENTION !

IN THE FOLLOWING THREE STEPS YOU WILL BEGIN THE INSTALLATION OF THE DECK SPACERS AND DECK BOARDS. IF YOU HAVE DIFFICULTY GETTING THE DECK BOARDS/DECK SPACERS TO FIT BETWEEN THE FRONT FACE BOARD AND REAR FACE BOARD DO THE FOLLOWING:

1: LOOSEN UP THE BOARDS ON THE LEFT AND RIGHT SIDES OF THE PLAY SET. REMOVE THE SCREWS ON ONE SIDE OF EACH DECK SPACER.

2: ALLOW THE DECK BOARDS TO DROP DOWN IN BETWEEN THE FRONT FACE BOARD AND REAR FACE BOARD.

3: TIGHTEN UP THE BOARDS ON THE LEFT AND RIGHT SIDES OF THE PLAY SET.

4: RE-INSTALL THE SCREWS IN THE DECK SPACERS. THEN INSTALL THE DECK BOARDS AS INDICATED IN THE INSTRUCTIONS.

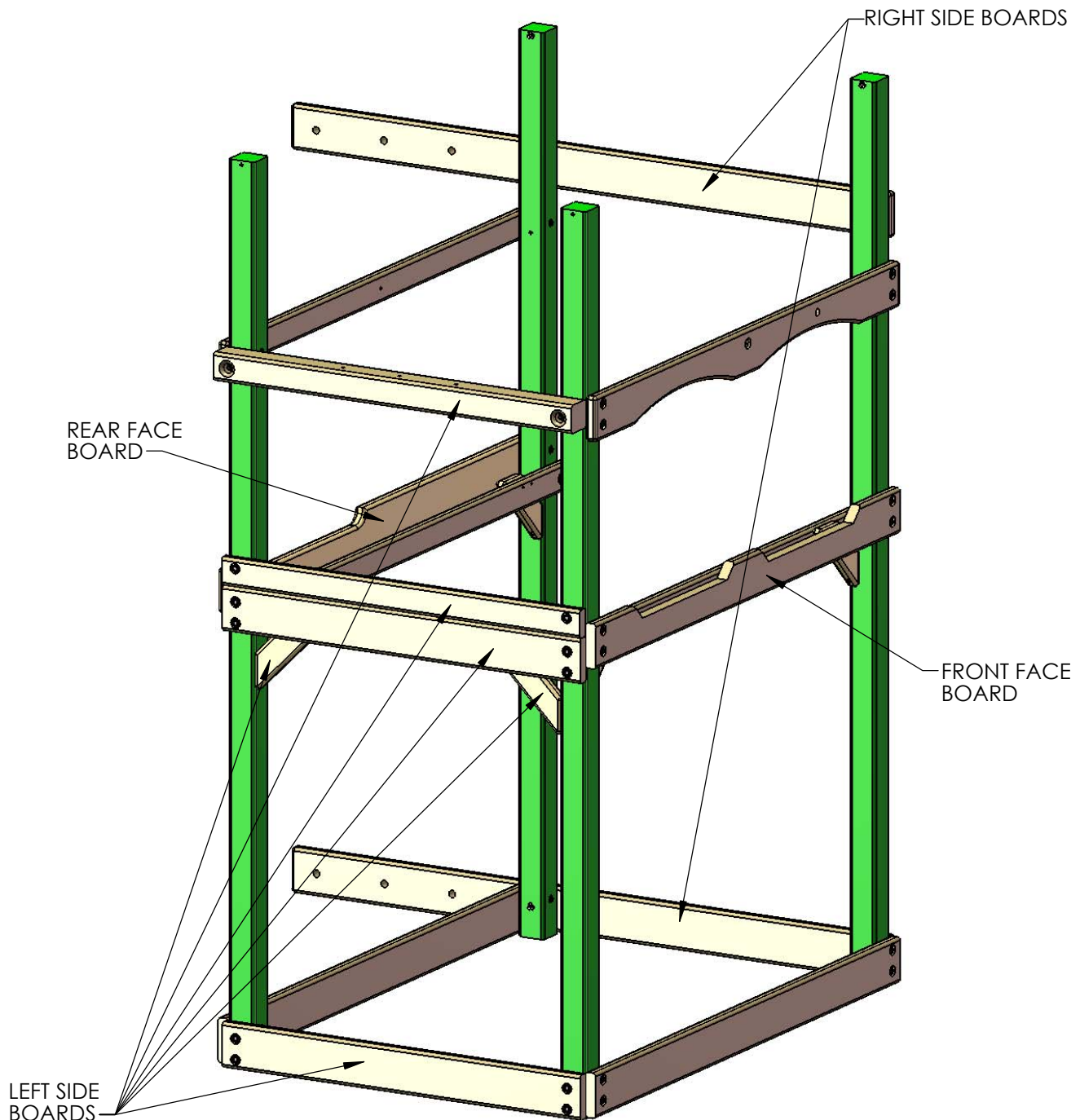

STEP 8: DECK SPACER AND DECK BOARD

1: PLACE THE 5/4 X 4 X 40-3/8" DECK SPACER BETWEEN THE CORNER POSTS ON THE LEFT SIDE OF THE FORT. FASTEN THE DECK SPACER TO THE DECK SUPPORTS WITH FOUR 2" WOOD SCREWS.

2: PLACE THE 5/4 X 6 X 47-3/8" DECK BOARD NEAR THE CORNER POSTS ON THE RIGHT SIDE OF THE FORT LEAVING A 1/4" GAP BETWEEN THE CORNER POSTS AND THE SIDE OF THE DECK BOARD. FASTEN THE DECK BOARD TO THE DECK SUPPORTS WITH 2" WOOD SCREWS.

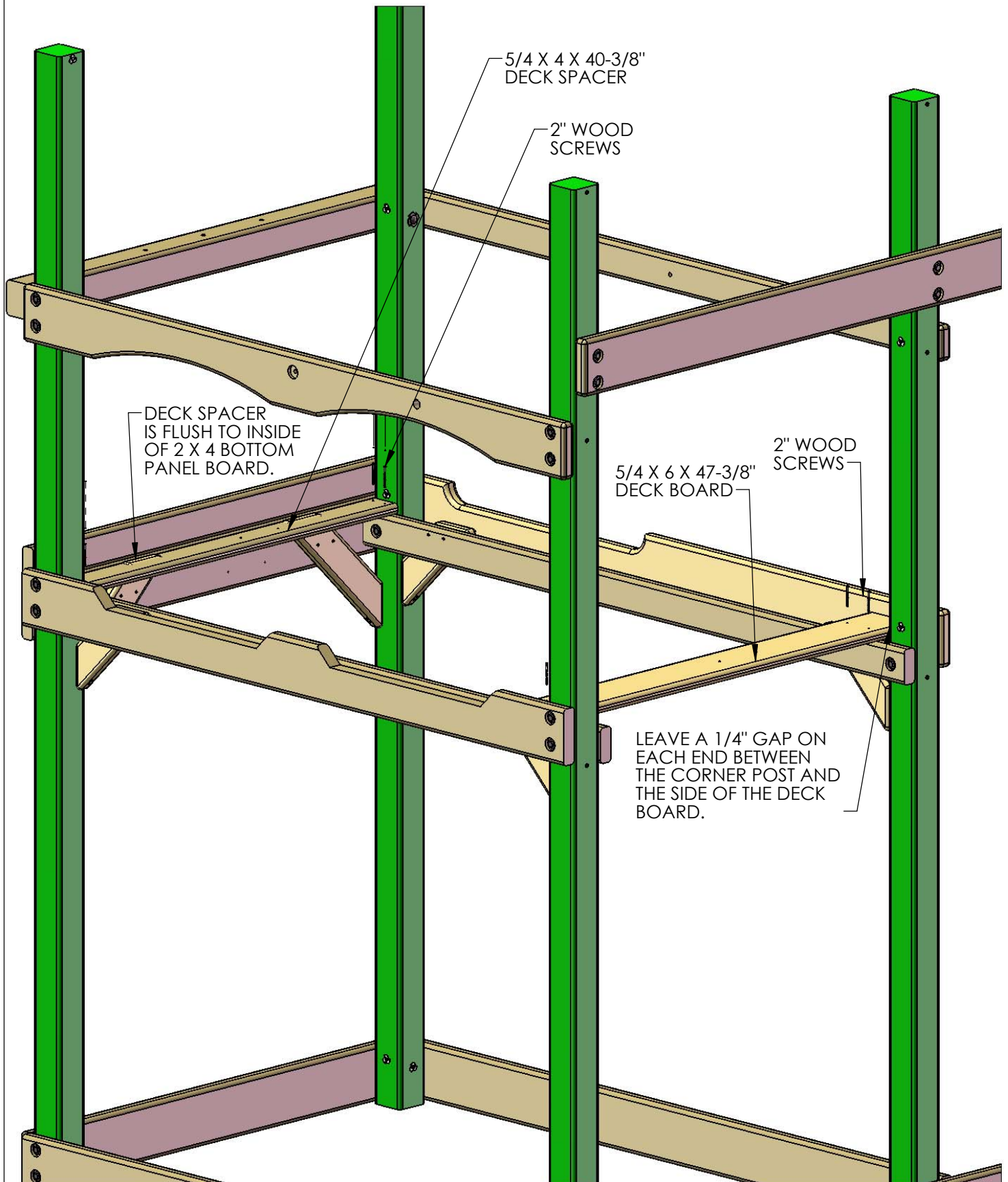

STEP 9: END WALL SLIDE MOUNT POST

1: FIND THE 4 X 4 X 40" END WALL SLIDE MOUNT POST.

2: MEASURE 26" INCHES FROM THE FRONT OF THE FRONT RIGHT CORNER POST AND MARK THE MEASUREMENT ON THE INSIDE OF THE 2 X 6 X 79-1/2" ROPE LADDER SUPPORT. MEASURE DOWN 2" FROM THE TOP OF THE ROPE LADDER SUPPORT AND MARK THE MEASUREMENT ON THE INSIDE. ALIGN THE TOP AND SIDE OF THE END WALL SLIDE MOUNT POST WITH THE MARKS.

3: USE THREE 2-1/2" WOOD SCREWS TO ATTACH THE END WALL SLIDE MOUNT POST TO THE ROPE LADDER SUPPORT FROM THE OUTSIDE OF THE ROPE LADDER SUPPORT.

4: THE END WALL SLIDE MOUNT POST CAN HANG FREELY AT THIS TIME.

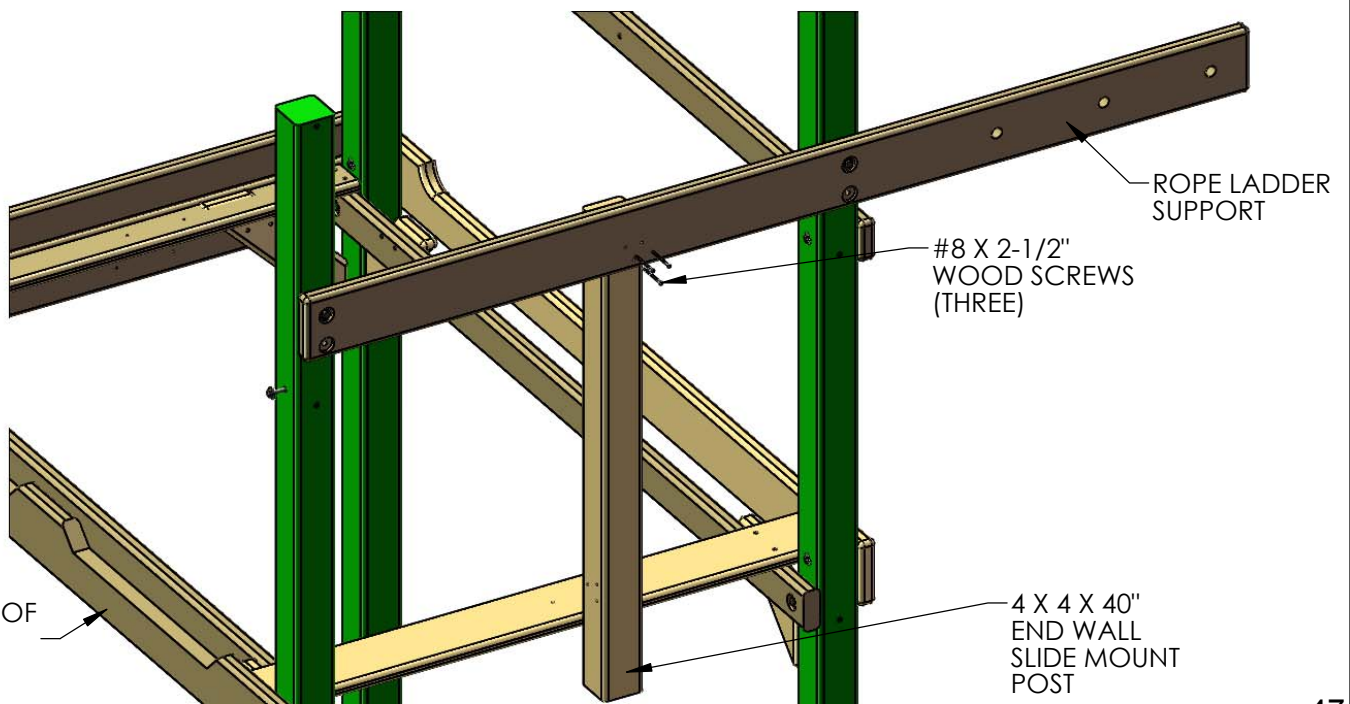
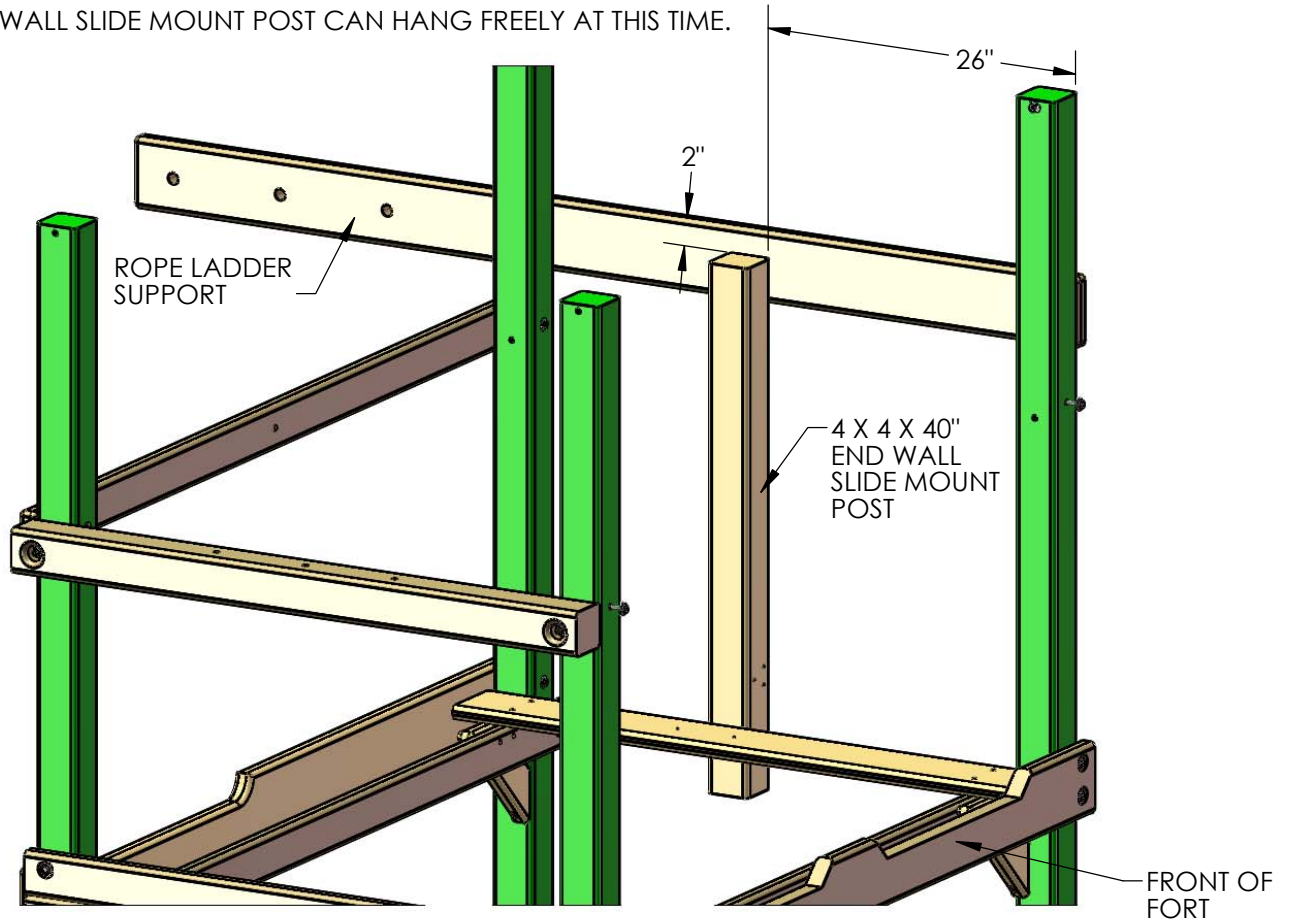

STEP 10: DECK SUPPORTS

1: PLACE TWO 2 X 4 X 70" DECK SUPPORTS UNDER THE DECK BOARD/DECK SPACER AND BESIDE THE POST. HAVE AN ASSISTANT HOLD UP THE END OF THE DECK SUPPORT ON THE LEFT END. THE LEFT END SHOULD BE FLUSH AGAINST THE 2 X 6 BOTTOM PANEL BOARD. THE END CLOSEST TO THE POST INSTALLED IN STEP 9 SHOULD BE FLUSH WITH THE OUTSIDE OF THE POST OR TOWARD THE INSIDE. ATTACH EACH DECK SUPPORT TO THE POST WITH THREE 2-1/2" WOOD SCREWS.

2: DRILL 1/8" PILOTHOLES THROUGH THE DECK BOARD AND DECK SPACER AS SHOWN IN THE TOP VIEW BELOW.

3: SECURE 2" WOOD SCREWS THROUGH THE DECK BOARD INTO THE DECK SUPPORTS.

4: NOW SECURE THE FAR END OF THE DECK SUPPORTS TO THE DECK SPACER WITH 2" WOOD SCREWS.

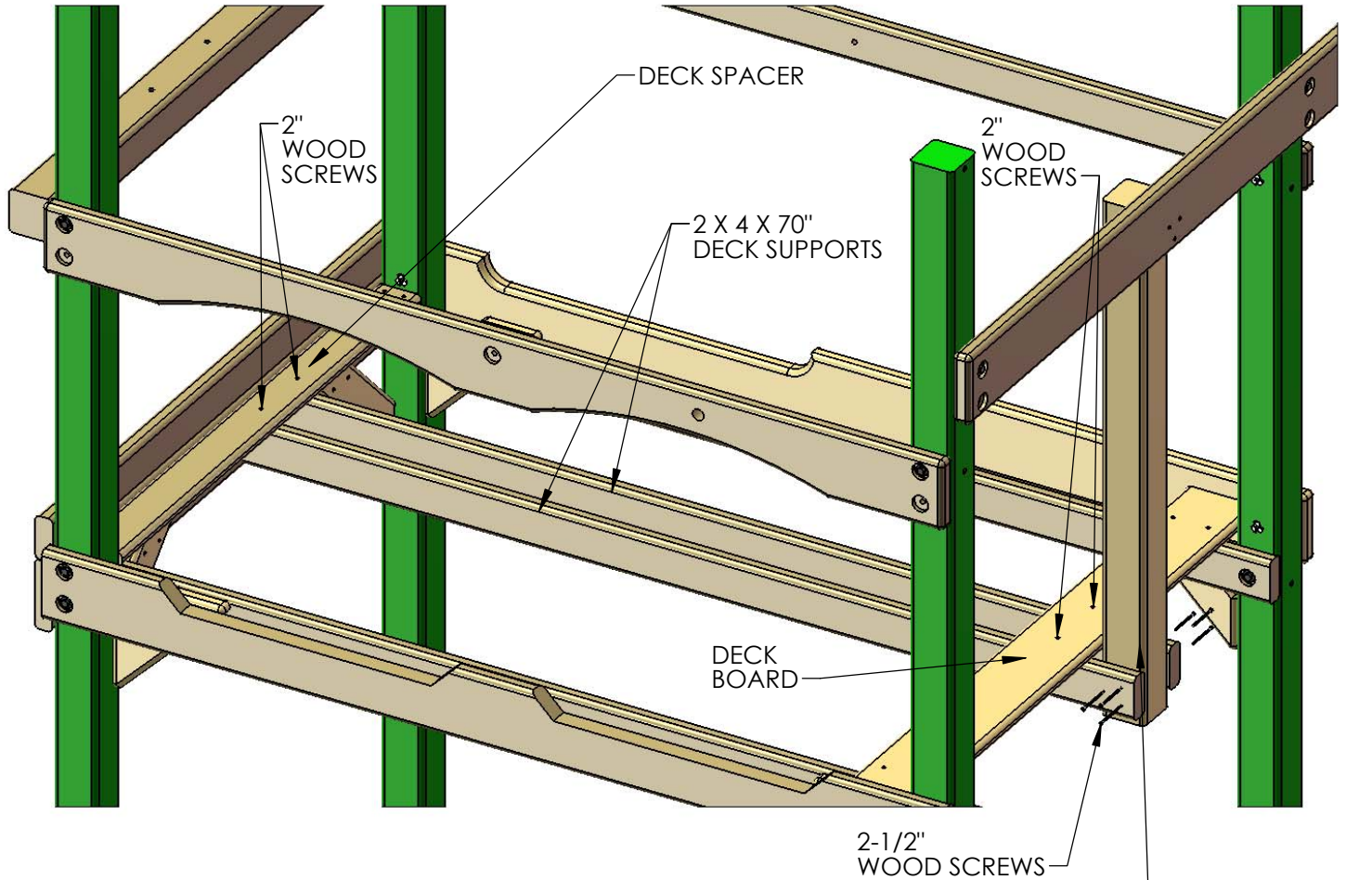

HAVE AN ASSISTANT HOLD THE END OF THE DECK SUPPORTS WHILE YOU PUT IN SCREWS THROUGH DECK BOARD AND DECK SPACER.

DRILL 1/8" HOLES

DECK SPACER

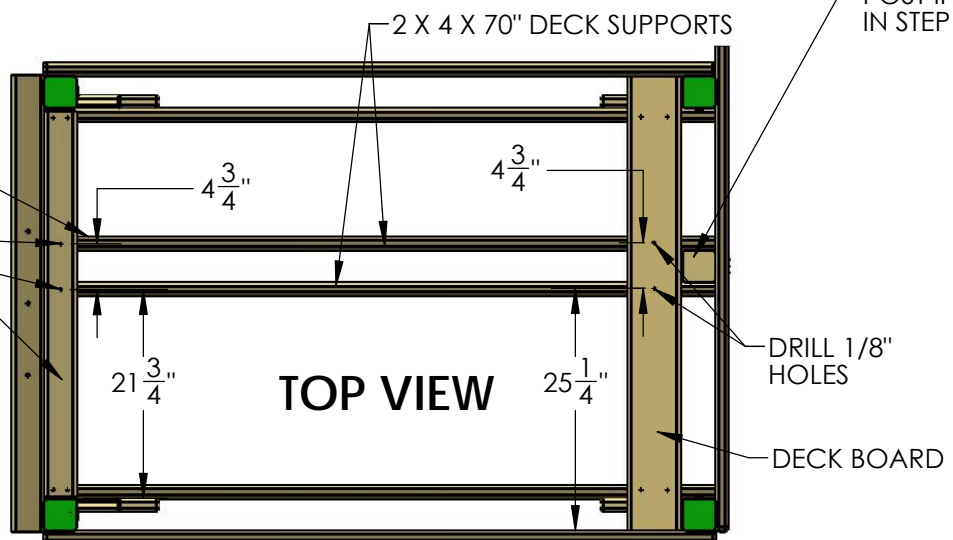

STEP 10A: DECK BOARDS

THE FOLLOWING STEP IS RECOMMENDED TO PREVENT POSSIBLE SPLITS IN THE WOOD

1: PRE-DRILL THE ENDS OF THE DECK BOARDS TO PREVENT INSTALLATION DAMAGE. PRE-DRILL BOTH ENDS WITH A 1/8" DRILL BIT AT THE DIMENSIONS SHOWN BELOW. THE HOLES AT 22-1/8" & 17-3/8" ONLY NEED TO BE DRILLED ONCE.

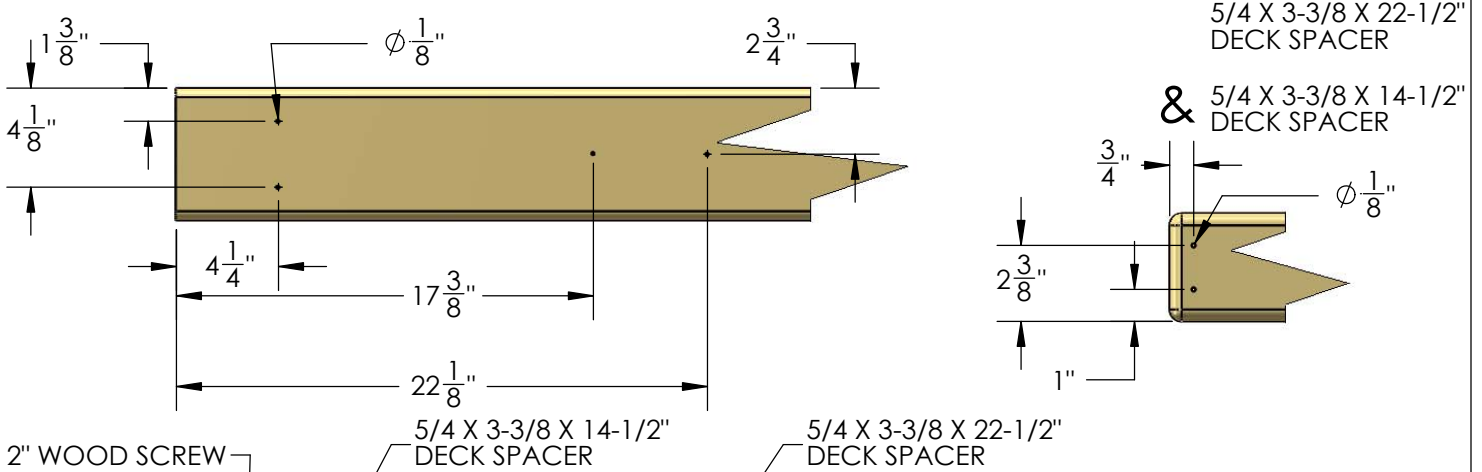

2: START WITH A 5/4 X 6 X 47-3/8" DECK BOARD AT ONE END OF THE FORT. CENTER THE BOARD BETWEEN THE FRONT FACE BOARD AND THE REAR BOTTOM PANEL BOARD AND ATTACH IT WITH 2" WOOD SCREWS THROUGH THE PREDRILED HOLES AND INTO THE DECK SUPPORT BELOW. LEAVE A UNIFORM (APPROX. 1/4") SPACE BETWEEN THE DECK BOARDS. NOTE: THE TOP OF THE SCREW HEAD SHOULD BE FLUSH TO THE TOP OF THE DECK BOARDS.

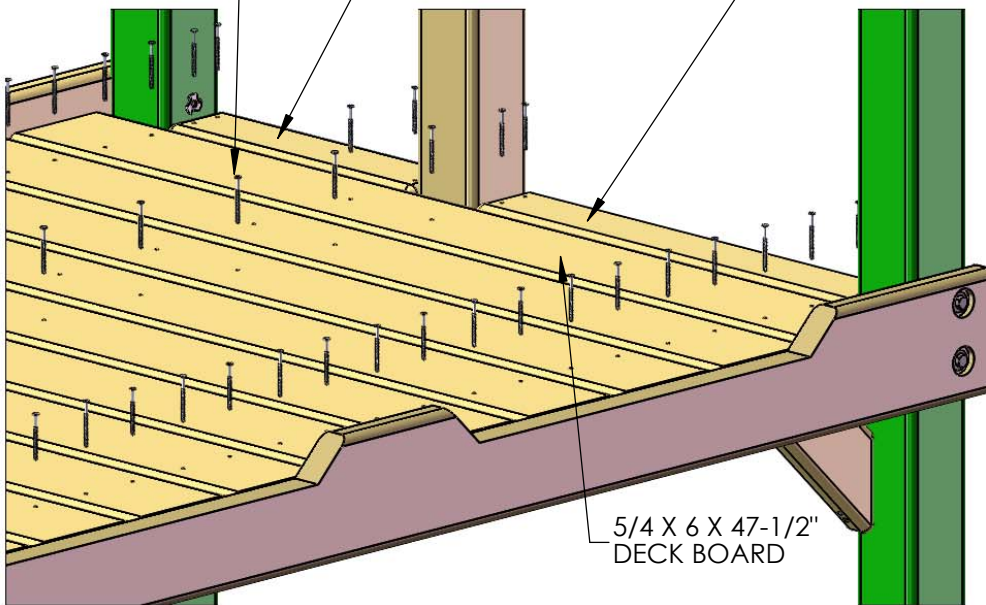

USE 2-1/2" WOOD SCREWS IN THESE LOCATIONS

2 X 6 BOTTOM PANEL BOARD

3: USING TWO 2-1/2" WOOD SCREWS, ATTACH THE 2 X 4 X 70" CENTER DECK SUPPORTS TO THE 2 X 6 BOTTOM PANEL BOARD.

4: FASTEN DECK SPACERS AND DECK BOARDS TO THE CENTER DECK SUPPORTS WITH 2" WOOD SCREWS.

CENTER DECK SUPPORTS

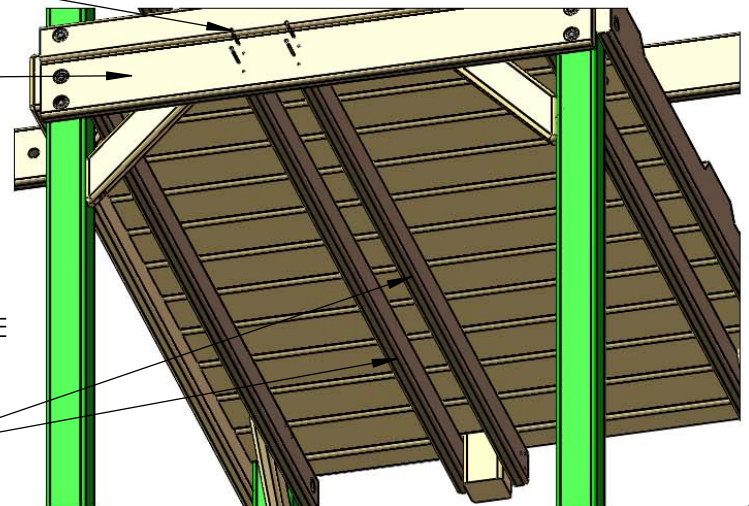

STEP 11: ROCK WALL

- 1: FIND TWO 2 X 4 X 66" ROCK WALL SIDES.
- 2: POSITION THE ROCK WALL SIDES SO THAT THE HOLES IN THE BOARDS ARE BOTH FACING THE SAME WAY.
- 3: INSERT T-NUTS INTO THE INSIDE OF THE ROCK WALL SIDES AND SET WITH A HAMMER.

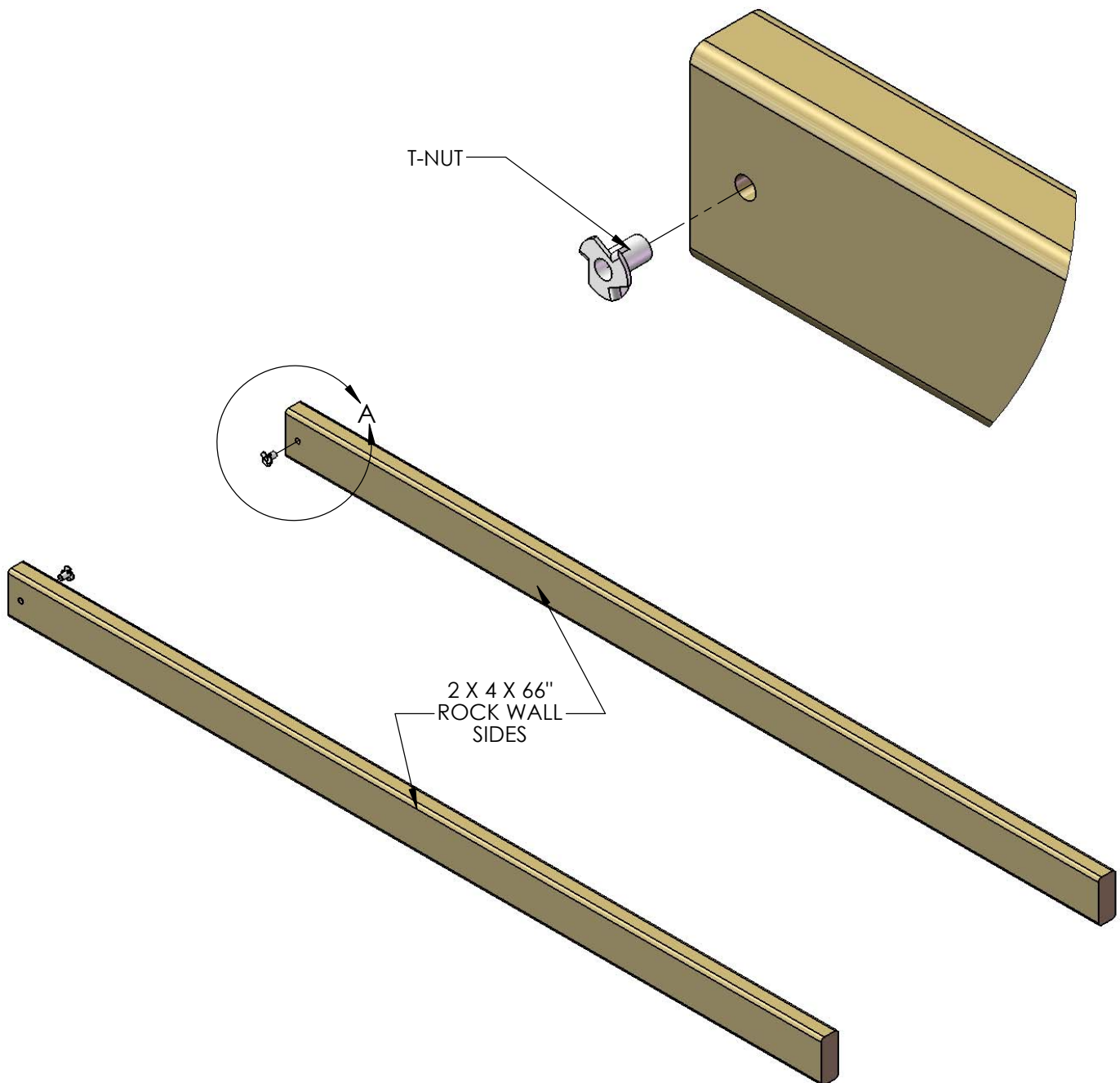

STEP 12: ROCK WALL

- 1: FIND ELEVEN 5/4 X 6 X 23-7/8" ROCK WALL BOARDS, AND ONE 5/4 X 6 X 23-7/8" BOTTOM ROCK WALL BOARD (1 HOLE).
- 2: STARTING FROM THE TOP, PLACE ONE ROCK WALL BOARD ON TOP OF THE ROCK WALL SIDES, FLUSH TO THE TOP OF THE ROCK WALL SIDES, AND ATTACH WITH TWO 2" WOOD SCREWS IN EACH SIDE.
- 3: CONTINUE DOWN THE ROCK WALL WITH THE REMAINING ROCK WALL BOARDS, FASTENING EACH BOARD WITH TWO 2" WOOD SCREWS ON EACH END.
- 4: THE FINAL BOARD WILL BE THE BOTTOM ROCK WALL BOARD WITH ONE HOLE. ATTACH WITH TWO 2" WOOD SCREWS PER SIDE.
- 5: IN SOME CASES, THERE WILL BE EXCESS LENGTH ON THE ROCK WALL SIDES. THIS IS DUE TO MILLING VARIATIONS, AND IS ALSO USED TO HELP LEVEL THE ROCK WALL SIDES ON UNEVEN GROUND.
- 6: ROCK WALL SIDES MAY NOT BE EVEN WITH THE BOTTOM ROCK WALL BOARD DUE TO MILLING VARIATIONS AND WOOD SHRINKAGE.

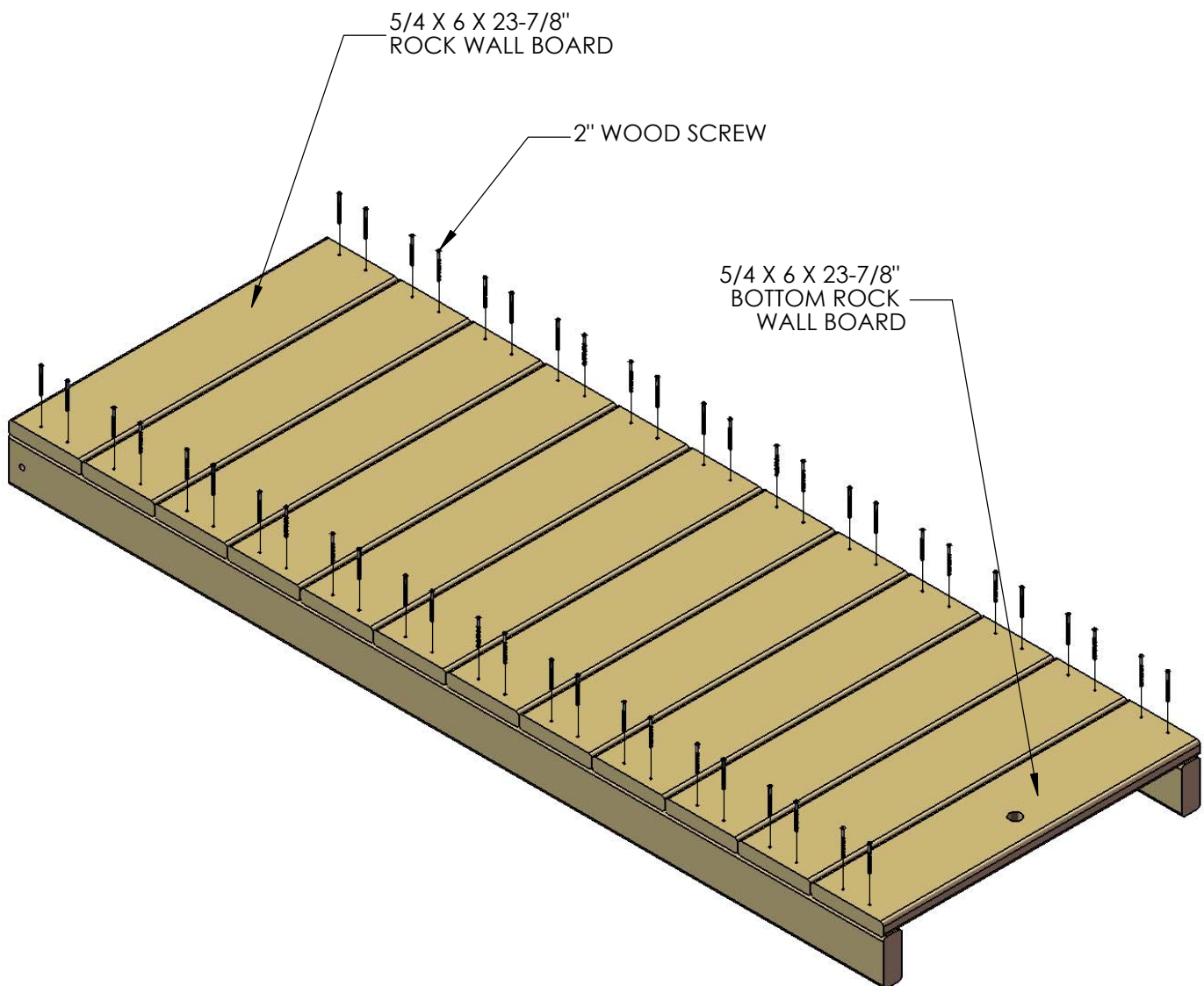

STEP 13: ROCK WALL

1: FASTEN THE 90° GREEN BRACKET TO THE ROCK WALL SIDES WITH 5/16" X 1-1/2" HEX BOLTS AND 5/16" WASHERS.

2: DO NOT FULLY TIGHTEN THE HEX BOLTS INTO THE T-NUTS AT THIS TIME.

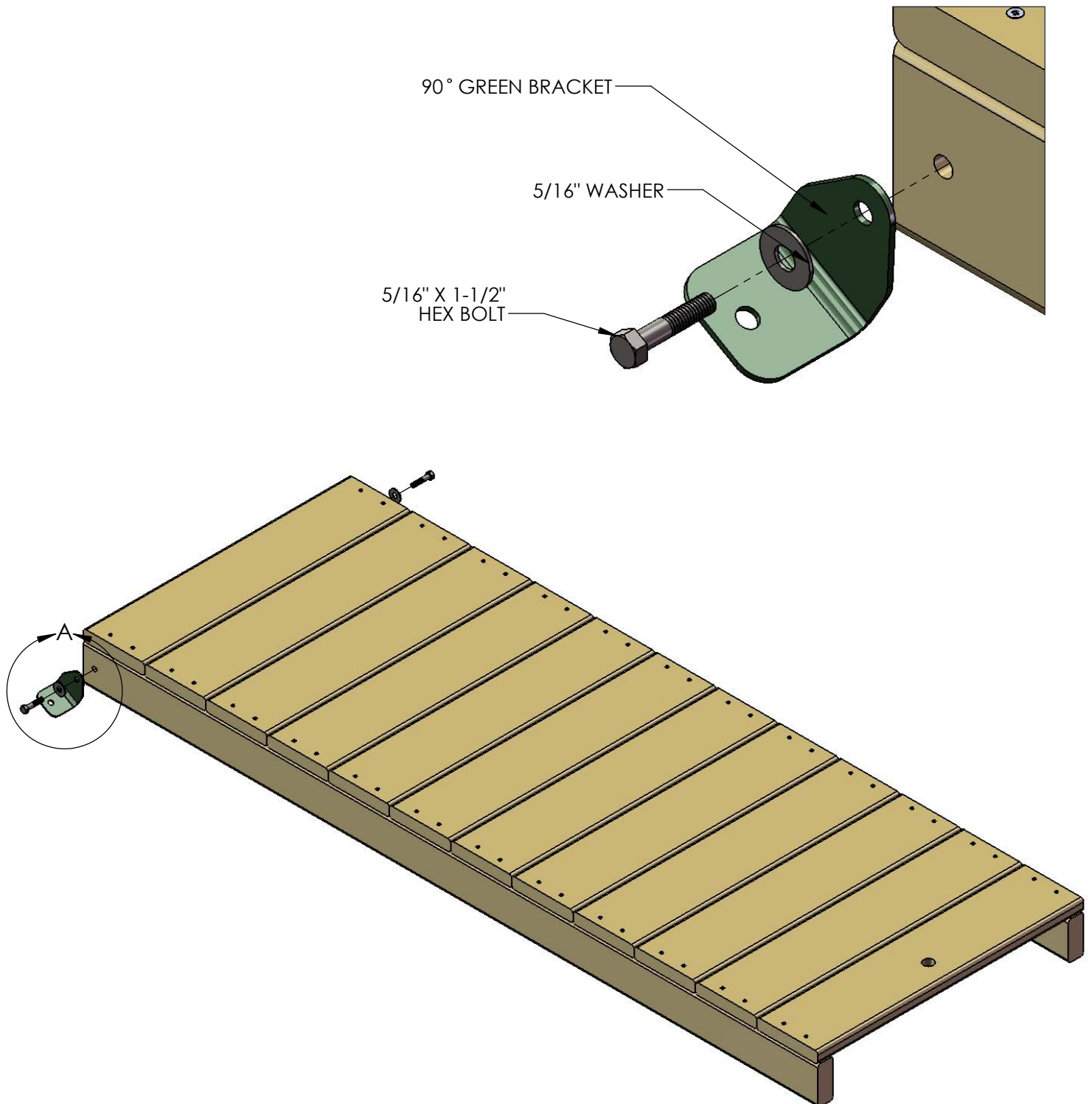

STEP 14: ROCK WALL

1: FIND TEN ROCKS AND THIRTY 1-1/4" PAN HEAD SCREWS AND WASHERS.

2: MOUNT THE ROCKS IN A STAGGERED MANNER ON THE ROCK WALL BOARDS. THREE PAN HEAD SCREWS WITH WASHERS WILL SECURE EACH ROCK TO THE WALL.

NOTE: THE IMAGE SHOWN BELOW IS A GENERIC ARRANGEMENT OF ROCKS ON THE ROCK WALL. YOUR ACTUAL CONFIGURATION MAY BE DIFFERENT THAT WHAT YOU SEE BELOW. ROCKS CAN BE ARRANGED IN ANY PATTERN AS LONG AS THEY WILL ALLOW PROPER ACCESS TO THE FORT. BE CREATIVE!

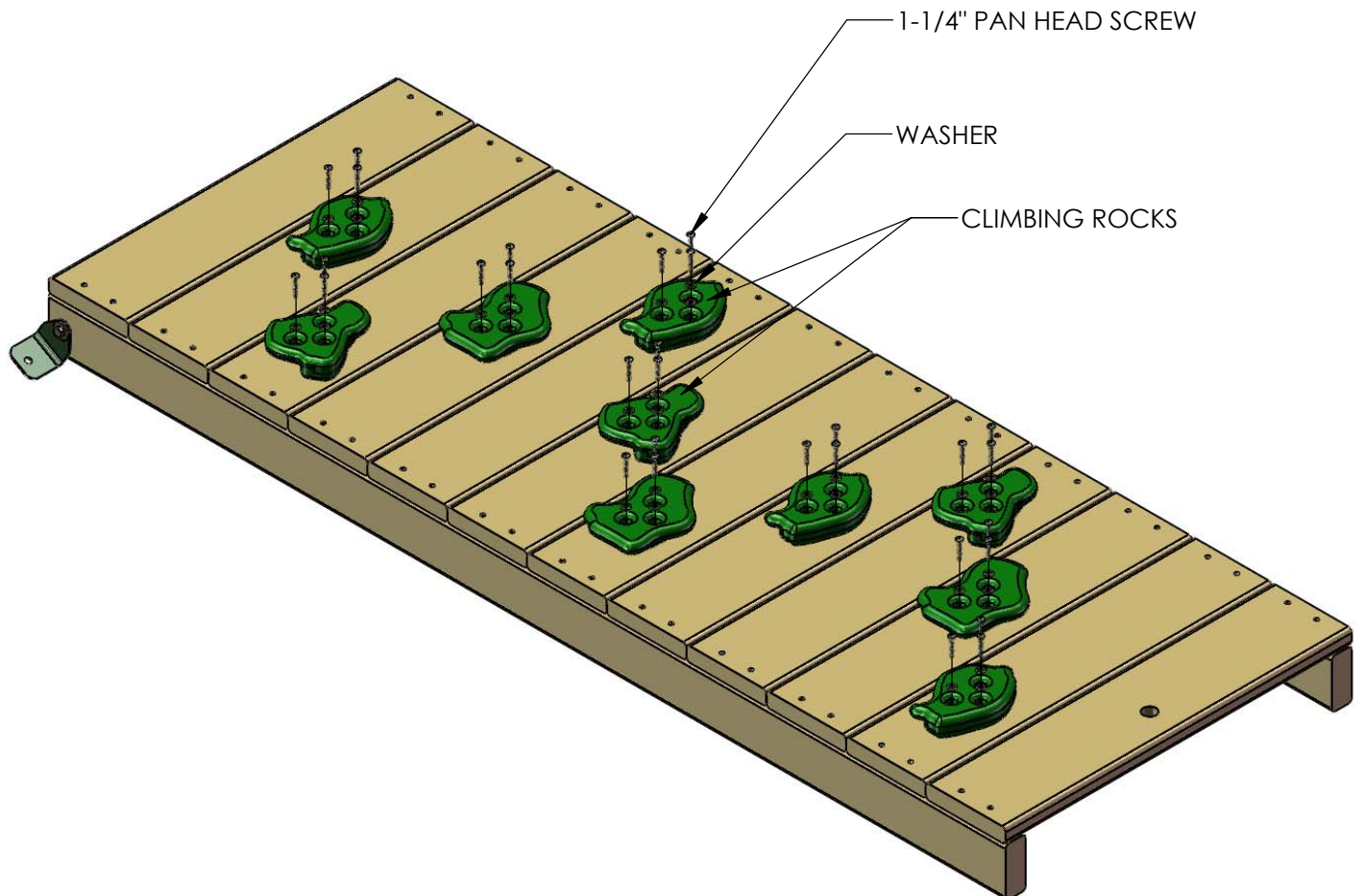

3: PLACE THE 5/4 X 2-5/8 X 23-7/8" ROCK WALL TOP CAP ON TOP OF THE ROCK WALL SIDES. FASTEN THE ROCK WALL TOP CAP TO THE ROCK WALL SIDES WITH 2" WOOD SCREWS.

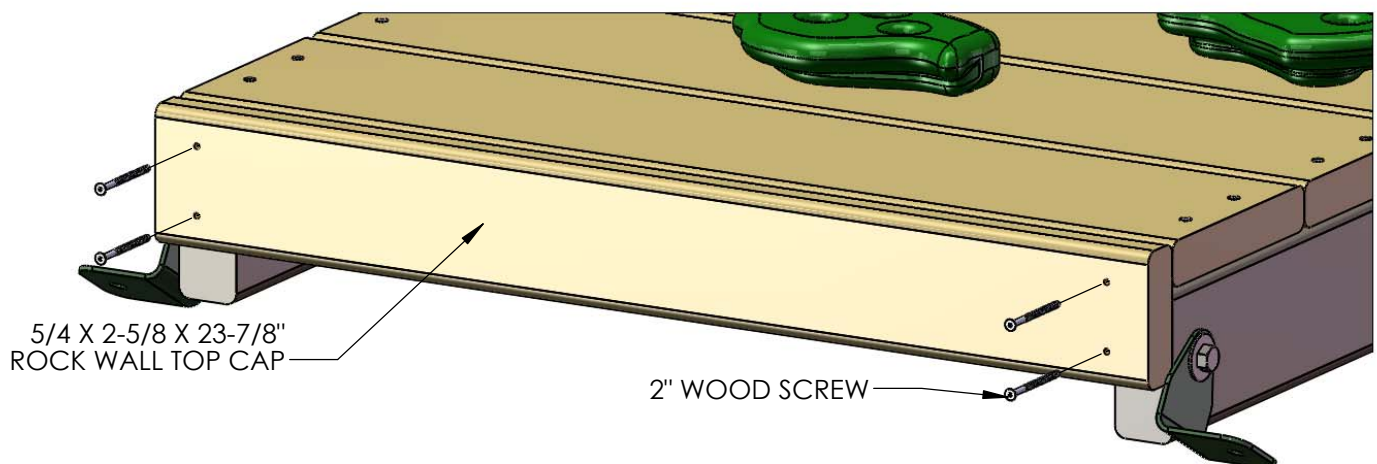

STEP 15: ATTACHING THE ROCK WALL

1: PLACE THE ROCK WALL INTO POSITION ON THE FORT AS SHOWN BELOW. THE BOTTOM OF THE 90 ° BRACKETS SHOULD BE 3/4" FROM THE BOTTOM OF THE FRONT FACE BOARD. USING THE 90 ° BRACKETS AS A TEMPLATE; DRILL A 3/8" HOLE THROUGH THE BOTTOM PANEL BOARD.

2: FROM THE UNDERSIDE OF THE DECK INSERT A T-NUT INTO THE BACKSIDE OF THE 3/8" HOLES IN THE FRONT FACE BOARD.

3: ATTACH THE ROCK WALL WITH 5/16 X 1-1/2" BOLTS AND 5/16" WASHERS.

4: WHEN THE BRACKETS ARE SECURE, AND THE ROCK WALL IS IN ITS FINAL POSITION; TIGHTEN THE 5/16 X 1-1/2" BOLTS ON THE ROCK WALL SIDES.

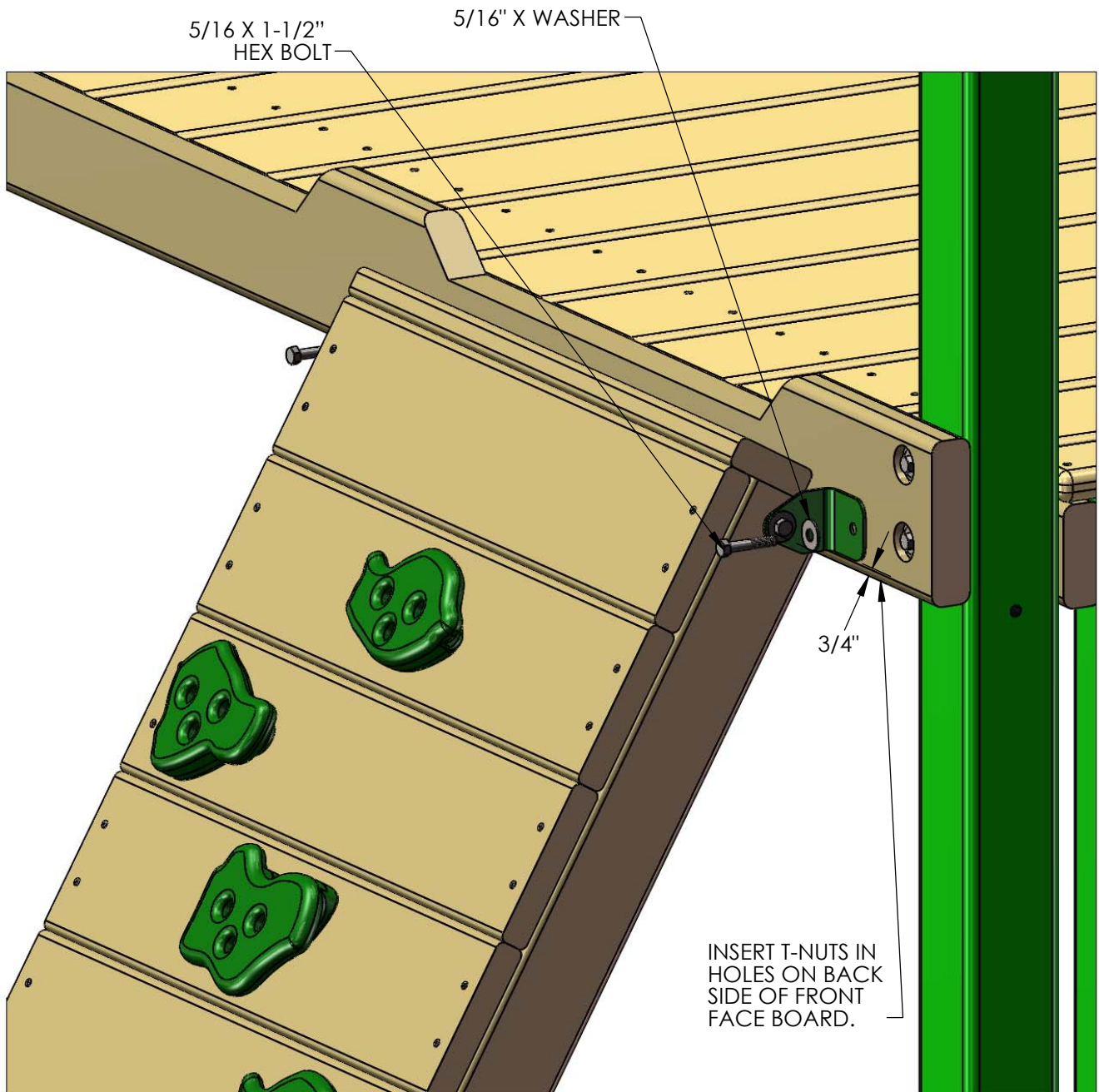

STEP 16: LADDER

1: FIND TWO 2 X 4 X 66" LADDER SIDES.

2: POSITION THE LADDER SIDES SO THAT THE SLOTS IN THE BOARDS ARE FACING EACH OTHER AND ARE PARALLEL.

3: INSERT T-NUTS INTO THE OUTSIDE OF THE LADDER SIDES AND SET WITH A HAMMER.

2 X 4 X 66"
LADDER SIDE

T-NUT

SLOTS ON BOTTOM

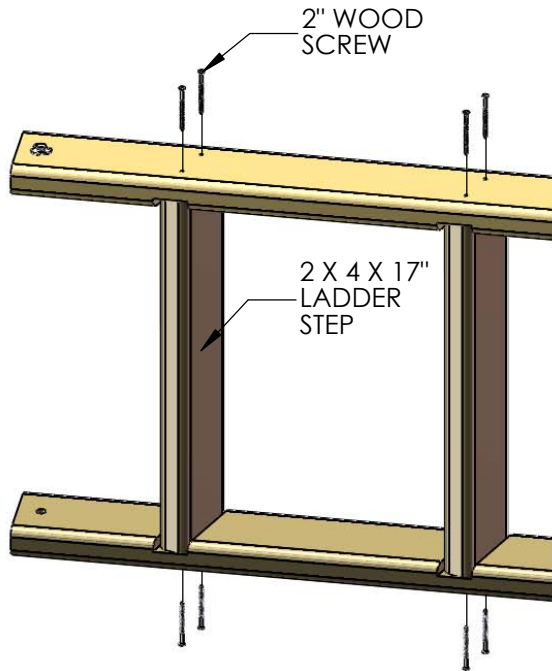
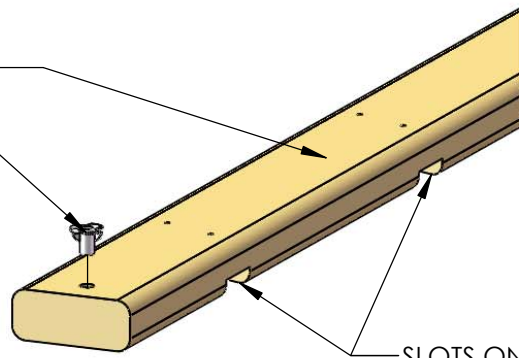

2" WOOD
SCREW

2 X 4 X 17"
LADDER
STEP

4: FIND FIVE 2 X 4 X 17" LADDER STEPS.

5: PLACE THE STEPS INTO THE SLOTS ON THE LADDER SIDES, AND FASTEN WITH 2" WOOD SCREWS.

6: CAREFULLY TURN THE LADDER OVER AND PUT THE SCREWS INTO THE OTHER SIDE.

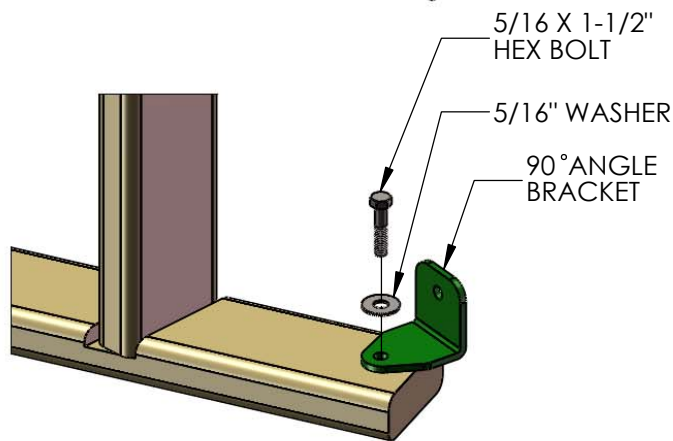

5/16 X 1-1/2"
HEX BOLT

5/16" WASHER

90° ANGLE
BRACKET

7: INSTALL THE 90° ANGLE BRACKETS TO THE INSIDE OF THE LADDER RAILS WITH 5/16 X 1-1/2" BOLTS, 5/16 WASHERS, INTO THE 5/16" T-NUTS.

8: INSTALL THE 5/4 X 3 X 18-3/4" LADDER BACK ABOVE THE TOP STEP OF THE LADDER WITH TWO 2" WOOD SCREWS PER SIDE.

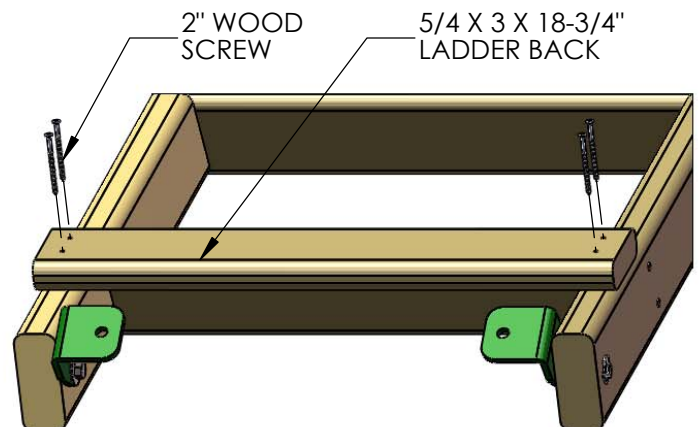

2" WOOD
SCREW

5/4 X 3 X 18-3/4"
LADDER BACK

STEP 17: LADDER TO FORT

- 1: CENTER THE LADDER IN THE OPENING OF THE REAR FACE BOARD ON THE REAR OF THE FORT AS SHOWN BELOW. THE BOTTOM OF THE 90° BRACKETS SHOULD BE 3/4" ABOVE THE BOTTOM OF THE REAR ENTRY BOARD. USING THE LADDER BRACKETS AS A TEMPLATE, DRILL A 3/8" HOLE THROUGH THE REAR ENTRY BOARD.
- 2: FROM THE UNDERSIDE OF THE DECK INSERT A T-NUT INTO THE BACKSIDE OF THE 3/8" HOLES ON THE REAR ENTRY BOARD.
- 3: ATTACH THE LADDER WITH 5/16 X 1-1/2" BOLTS AND 5/16" WASHERS.
- 4: WHEN THE BRACKETS ARE SECURE, AND THE LADDER IS IN ITS FINAL POSITION; TIGHTEN THE 5/16 X 1-1/2" BOLTS ON THE LADDER SIDES.

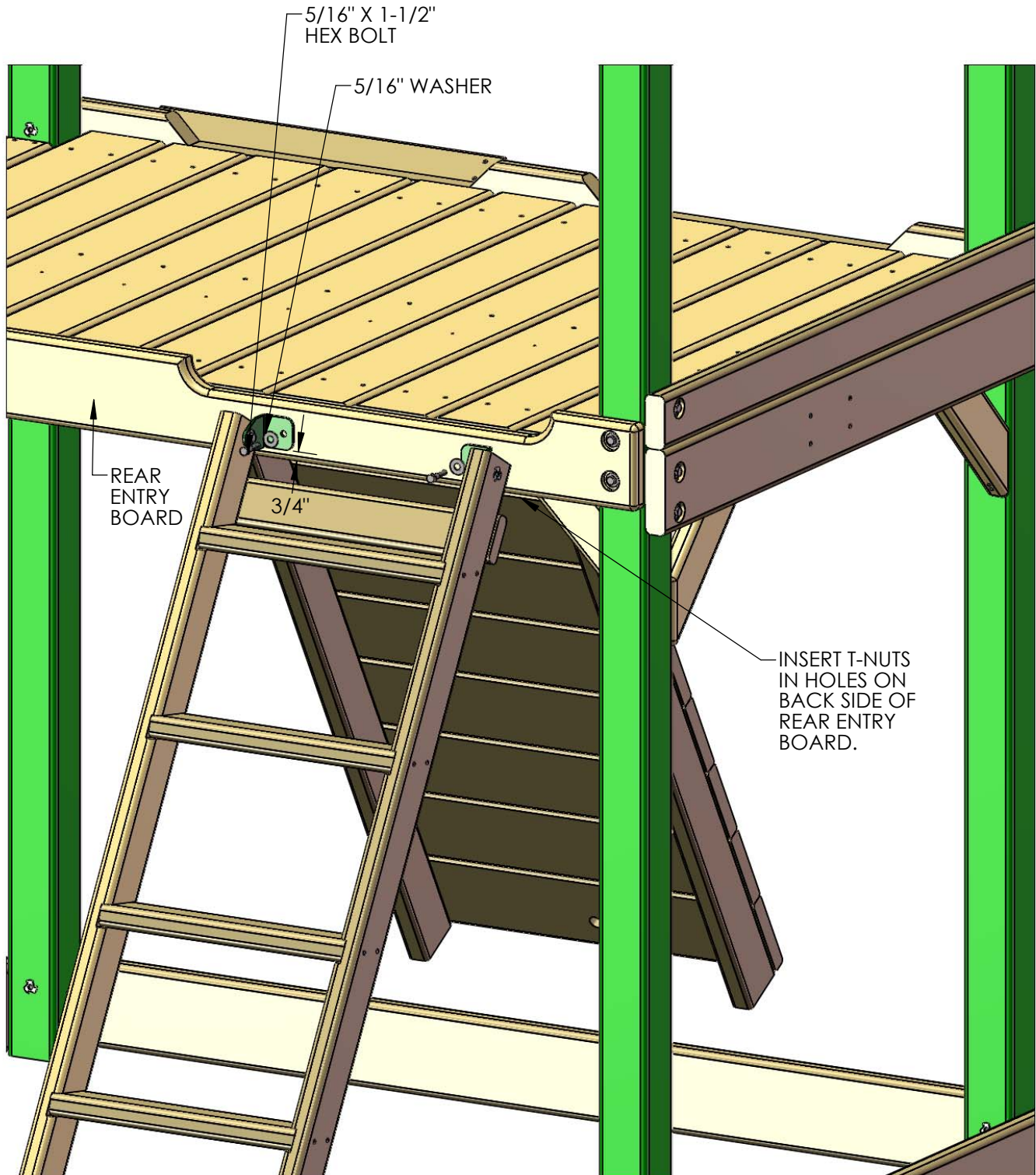

STEP 18: CENTER POST FRONT/REAR

1: HAMMER A T-NUT INTO THE HOLE OF EACH 2 X 4 X 28-9/16" CENTER POST FRONT/REAR.

2: PLACE THE CENTER POST INSIDE THE RAILINGS AT THE FRONT AND REAR OF THE PLAYSET. LINE UP THE HOLES IN THE CENTER POSTS WITH THE HOLES IN THE RAILINGS.

3: FASTEN THE CENTER POSTS TO THE RAILINGS WITH 5/16" X 2-1/2" HEX BOLTS AND 5/16" WASHERS AT THE TOP.

4: SQUARE EACH CENTER POST TO THE DECK AND SECURE THE BOTTOM OF THE CENTER POST TO THE BOTTOM PANEL BOARDS WITH #8 X 2-1/2" WOOD SCREWS.

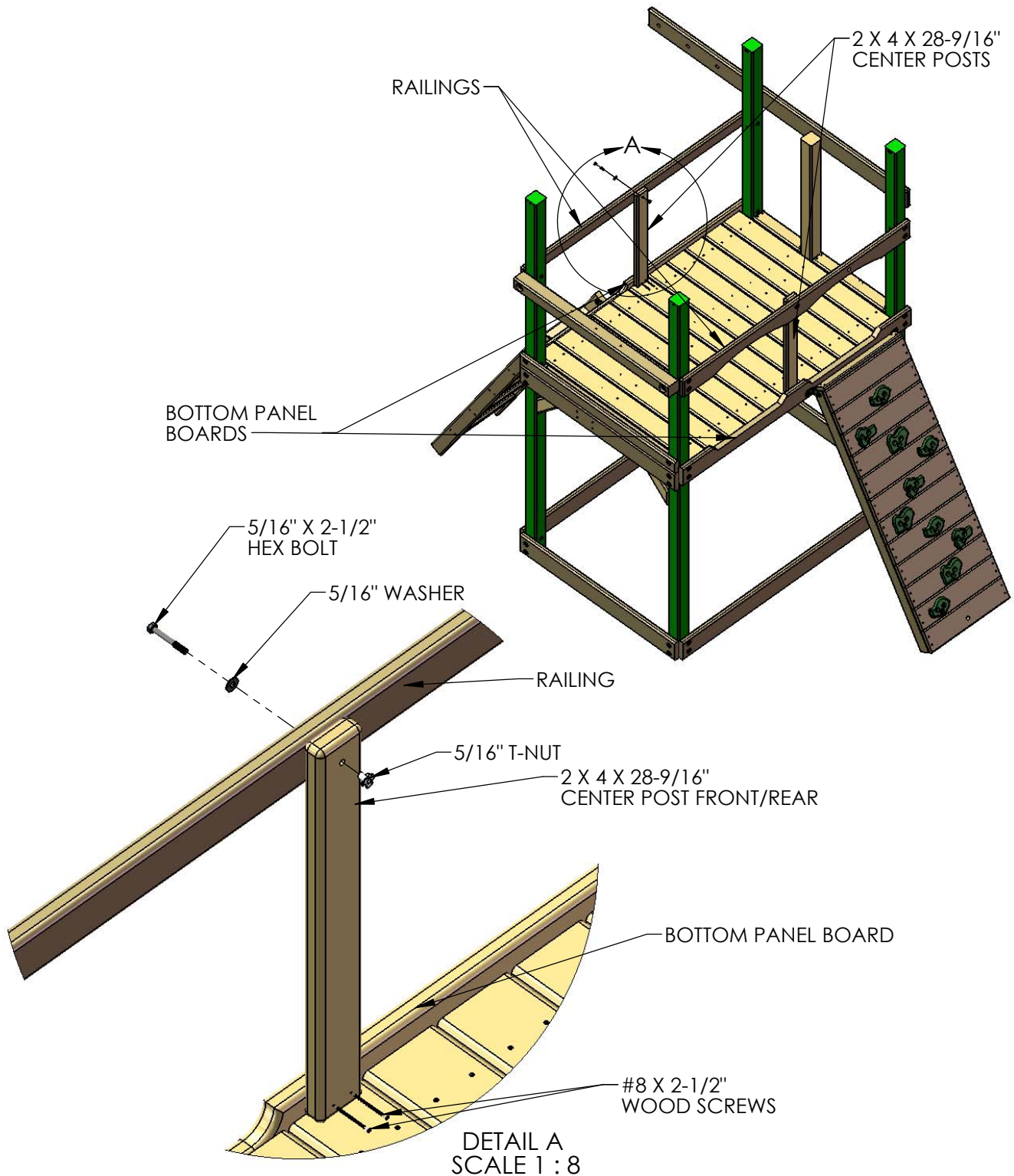

STEP 19: PANEL SLATS

- 1: FIND THIRTEEN 5/4 X 2-5/8 X 28-1/4" PANEL SLATS.
- 2: PRE-DRILL THE SLATS 1" FROM EACH END ON CENTER WITH A 1/8" DRILL BIT.
- 3: INSTALL THE PANEL SLATS AT EQUAL LENGTHS. SEE DETAIL BELOW FOR MEASUREMENTS.
- 4: ATTACH THE PANEL SLATS TO THE FORT WITH 2" WOOD SCREWS IN THE PRE-DRILLED HOLES.

REAR PANEL SLAT SPACING

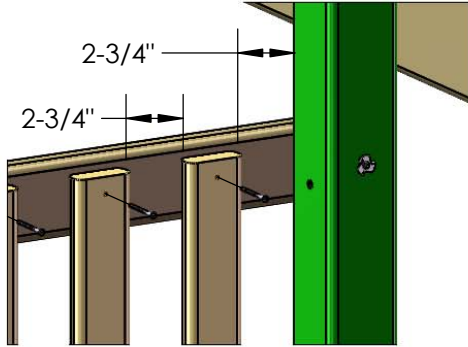

DETAIL C
SCALE 1 : 8

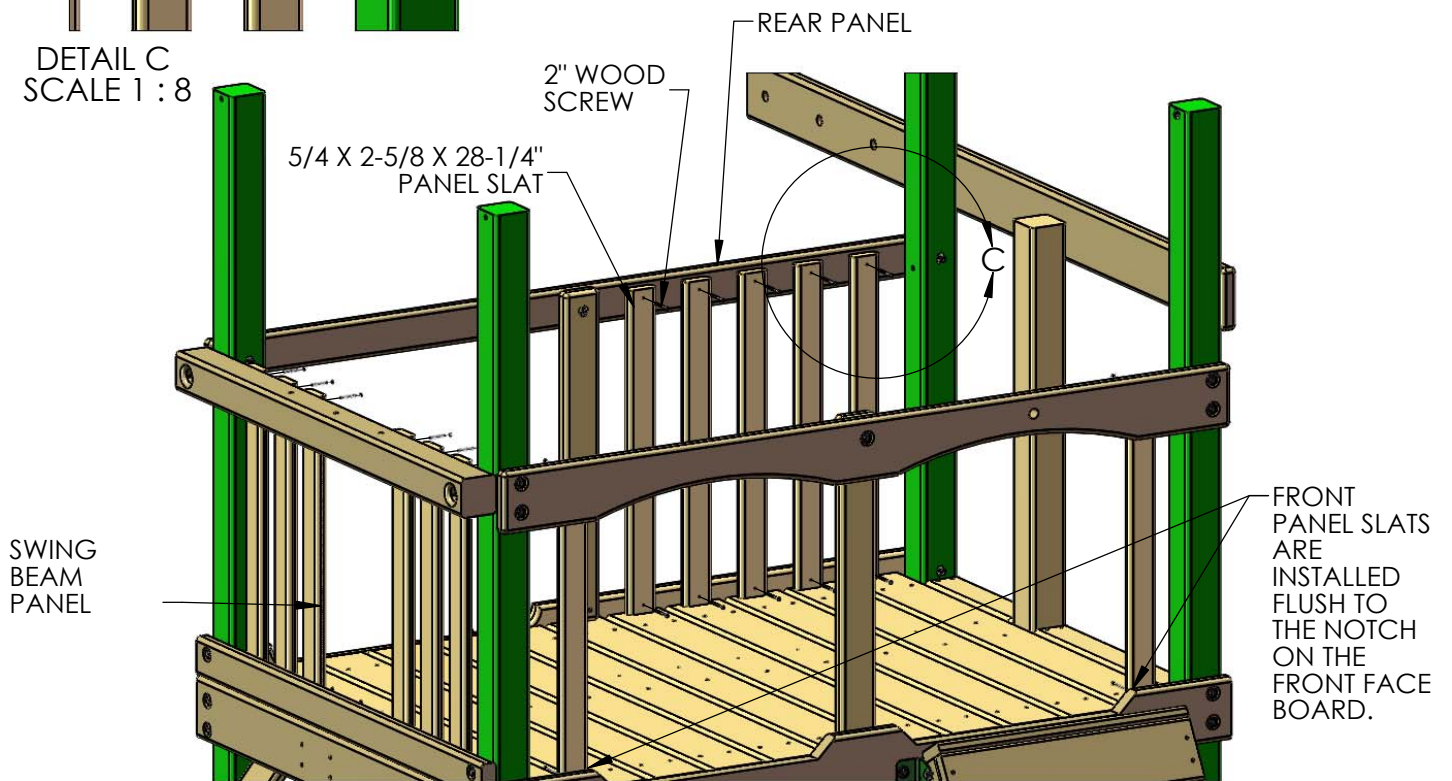

SWING
BEAM
PANEL

FRONT
PANEL SLATS
ARE
INSTALLED
FLUSH TO
THE NOTCH
ON THE
FRONT FACE
BOARD.

SWING BEAM PANEL

SLAT DIMENSIONS
(VIEW FROM OUTSIDE
THE PLAY SET.)

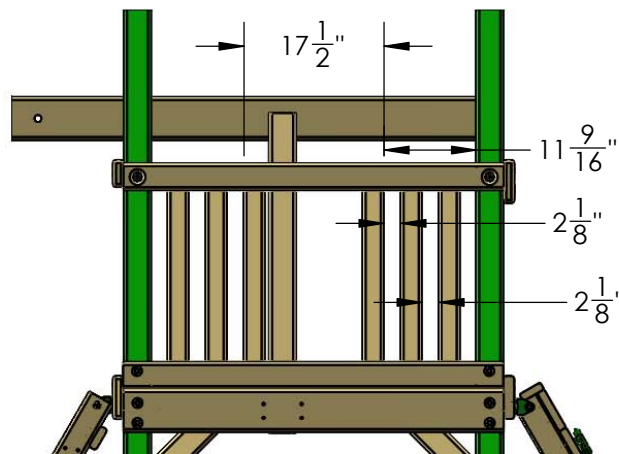

STEP 20: SWING BEAM PLATE

1: PLACE THE SWING BEAM PLATE ON TOP OF THE SWING BEAM SUPPORT, LINING UP THE PILOT HOLES.

2: FASTEN THE SWING BEAM PLATE TO THE SWING BEAM SUPPORT USING 3-1/2" CARRIAGE BOLTS ON TOP, AND 3/8" LOCK NUTS WITH 3/8" WASHERS FROM UNDERNEATH, IN THE COUNTER-SUNK HOLES OF THE SWING BEAM SUPPORT. USE BOLT CAPS TO COVER ANY EXPOSED THREADS.

3: LEAVE THE MIDDLE HOLE EMPTY, IT WILL BE USED LATER.

4: IF NECESSARY USE LOCKING PLIERS TO HOLD CARRIAGE BOLTS IN PLACE WHEN INSTALLING.

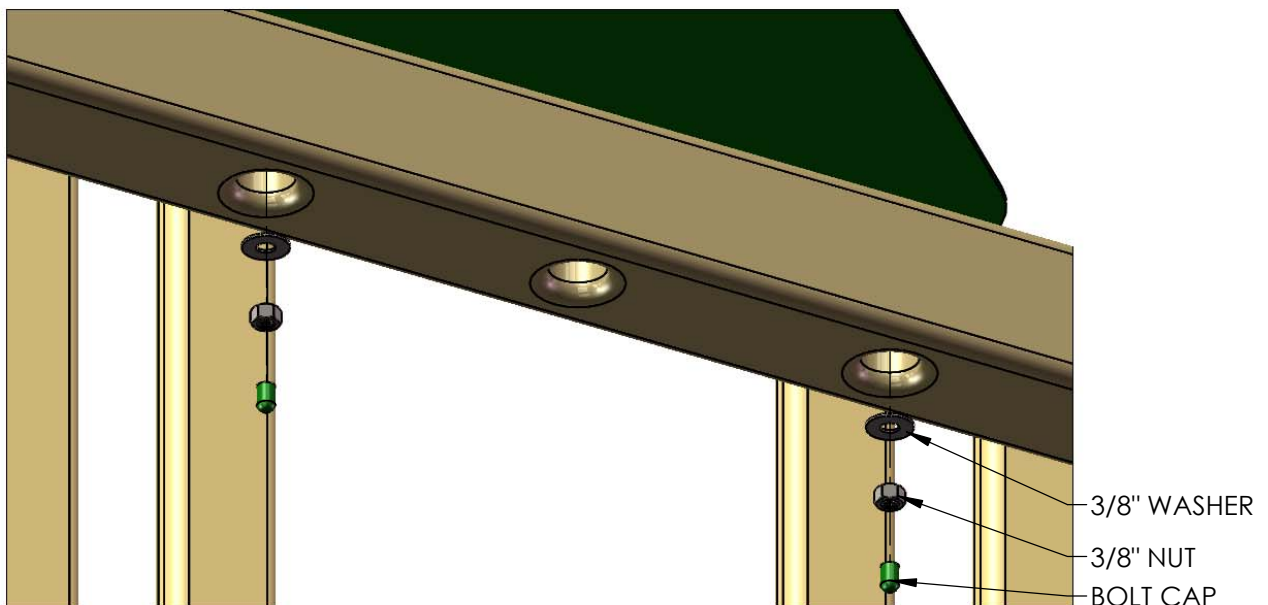
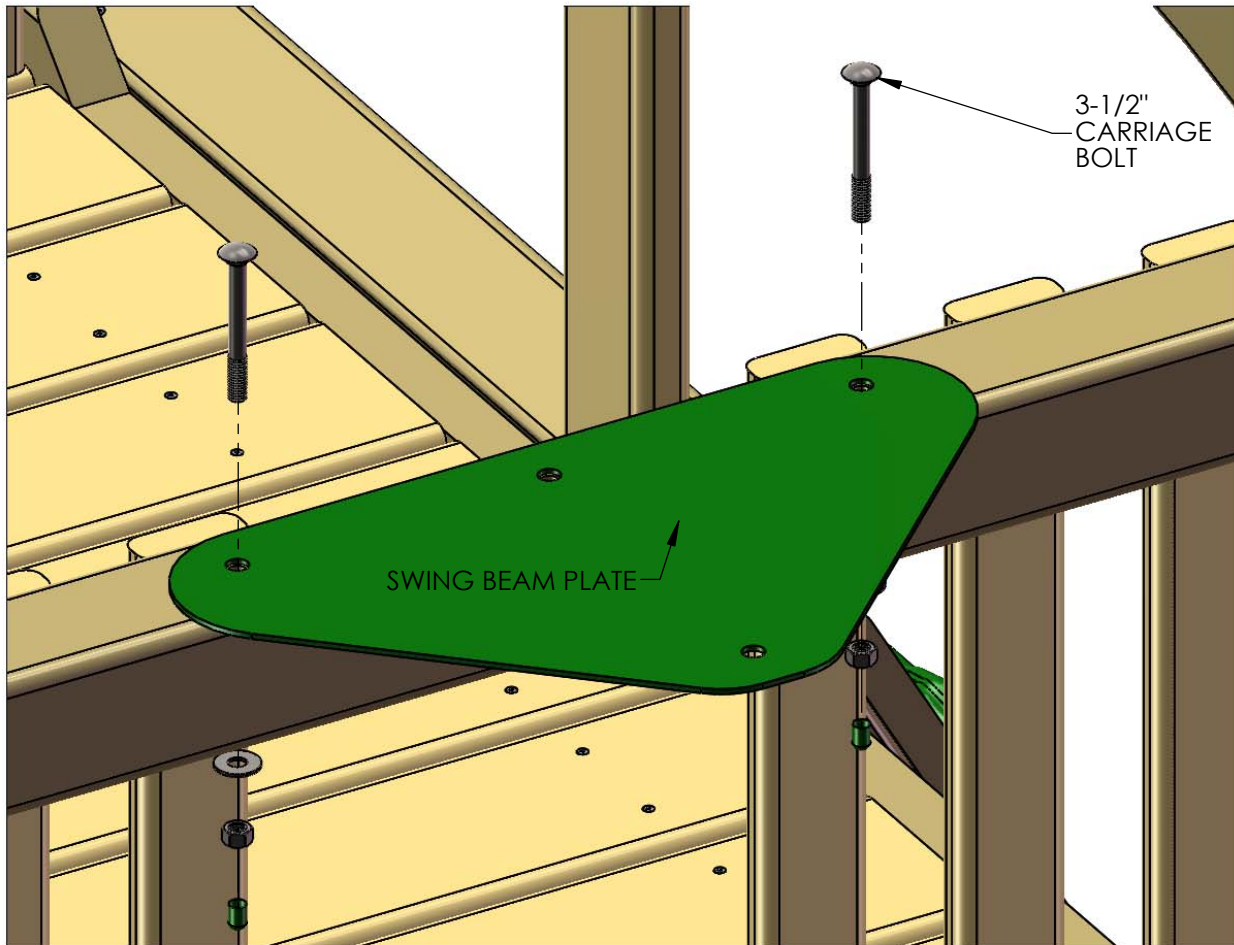

STEP 21: IRON DUCTILE SWING HANGERS

- 1: LINE UP THE HOLES OF THE IRON DUCTILE SWING HANGERS WITH THE HOLES IN THE SWING BEAM. IF YOUR BEAM IS BOWED SLIGHTLY PLACE THE BOW SIDE UP; THE SWING HANGERS WILL BE ON THE BOTTOM.
- 2: FASTEN THE SWING HANGER TO THE SWING BEAM USING 7" CARRIAGE BOLTS WITH TORQUE WASHERS, AND 3/8" WASHERS WITH 3/8" LOCK NUTS.
- 3: PLACE BOLT CAPS OVER EXPOSED THREADS.

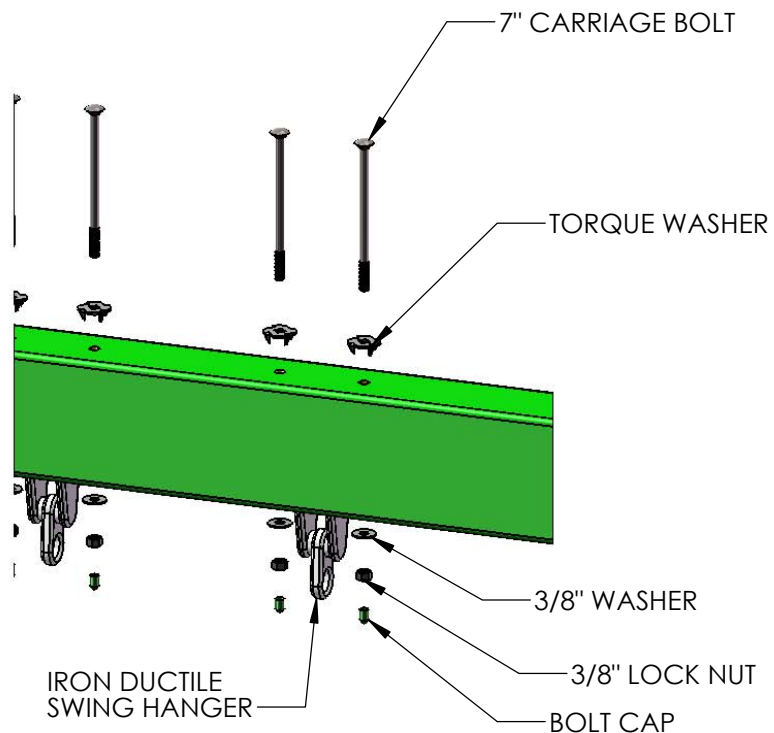
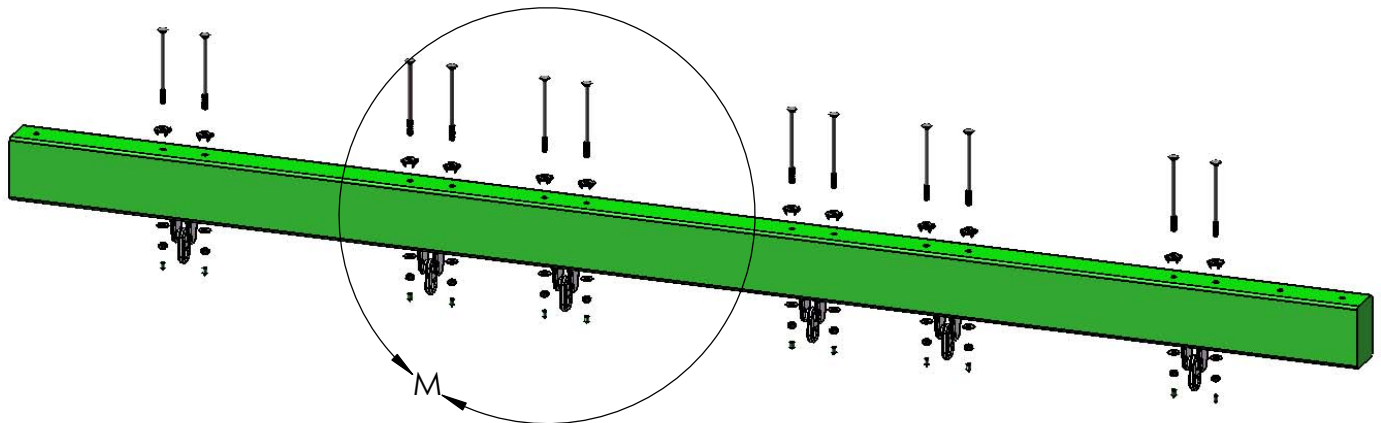

DETAIL M
SCALE 1 : 8

STEP 22: ATTACH SWING LEGS TO BRACKET

1: PLACE THE 4 X 4 X 108" SWING LEGS FLUSH TO THE TOP OF THE SWING LEG BRACKET.

2: FASTEN THE SWING LEGS TO THE SWING LEG BRACKET WITH 3/8 X 3-1/2" LAG SCREWS AND 3/8" WASHERS.

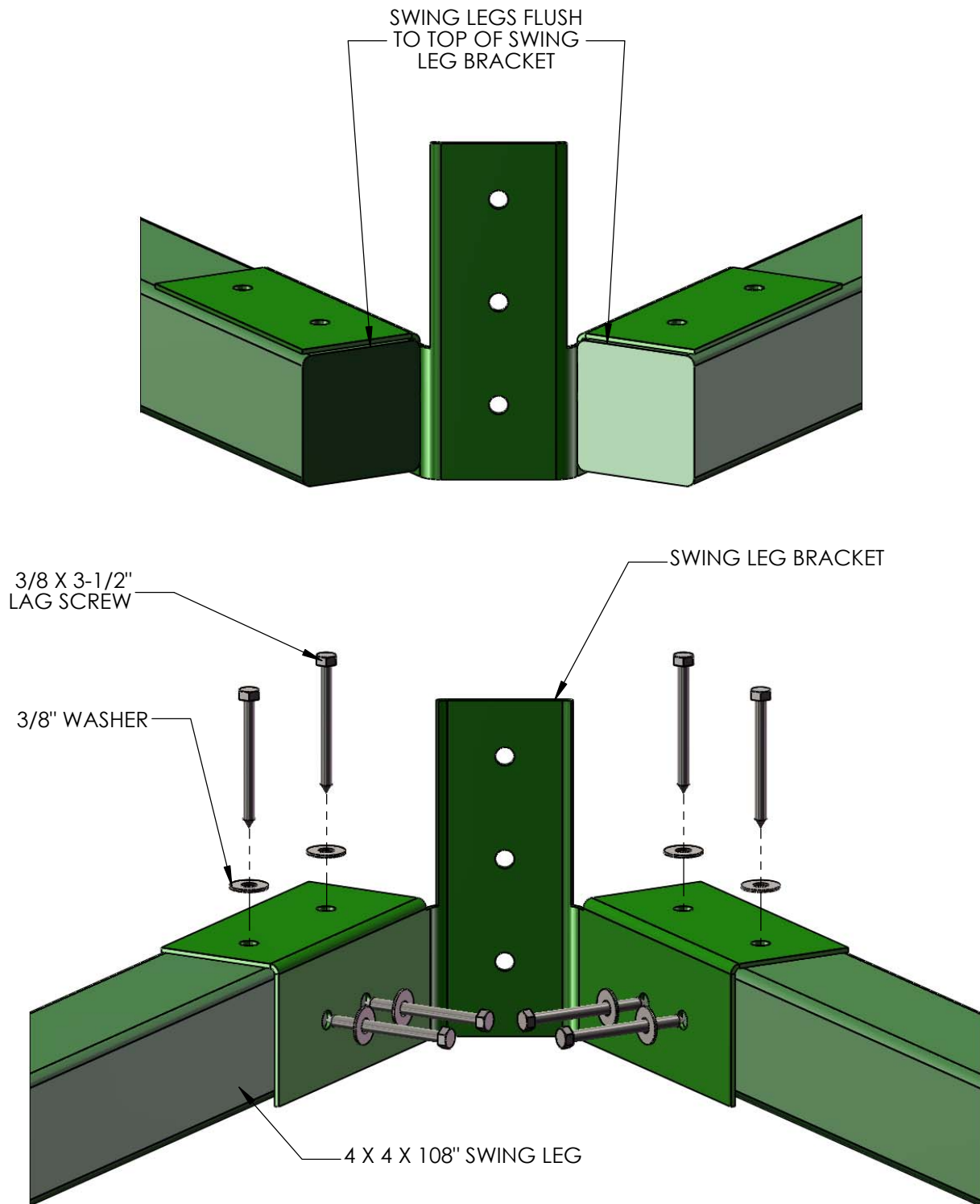

STEP 23: REST SWING BEAM ON FORT

*TWO PEOPLE ARE REQUIRED FOR THIS STEP

1: LAY THE SWING BEAM ACROSS THE TOP OF THE FORT RAILINGS. THE END OF THE SWING BEAM WITH TWO EMPTY HOLES SHOULD OVERHANG THE SIDE OF THE FORT WITH THE TRIANGULAR SWING BEAM PLATE.

2: SIT THE SWING BEAM LEGS UPRIGHT UNDER THE TWO EMPTY HOLES IN THE END OF THE SWING BEAM.

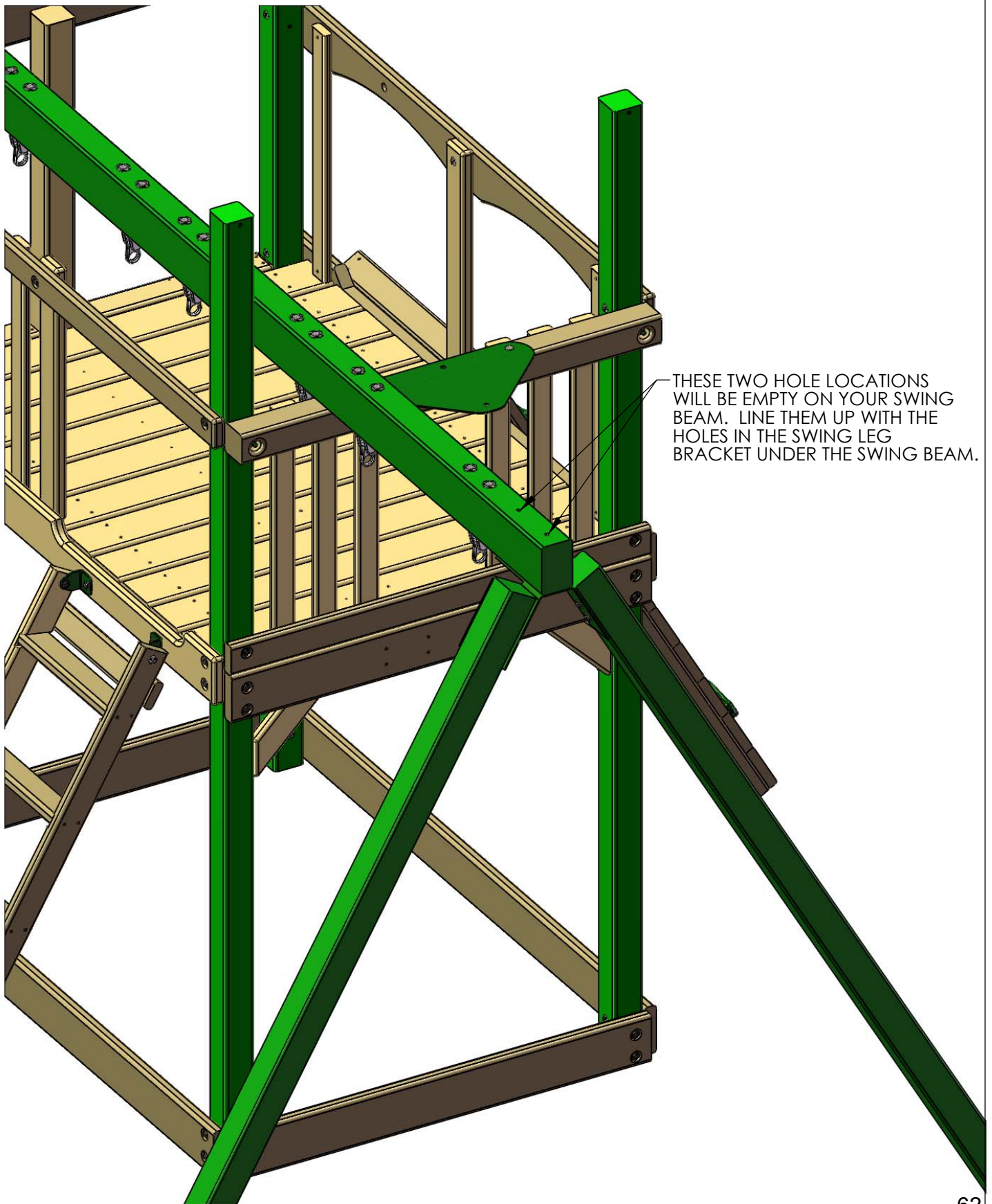

STEP 24: MOUNT SWING BEAM TO SWING BEAM LEGS

1: FASTEN THE SWING BEAM TO THE SWING BEAM BRACKET USING 7" CARRIAGE BOLTS WITH TORQUE WASHERS ON TOP OF THE SWING BEAM, AND 3/8" LOCK NUTS WITH 3/8" WASHERS FROM UNDERNEATH.

2: USE A 3/8 X 3-1/2" LAG SCREW WITH 3/8" WASHER FOR THE HOLE IN THE CENTER OF THE SWING BEAM BRACKET.

3: PLACE A BOLT CAP OVER ANY EXPOSED THREADS.

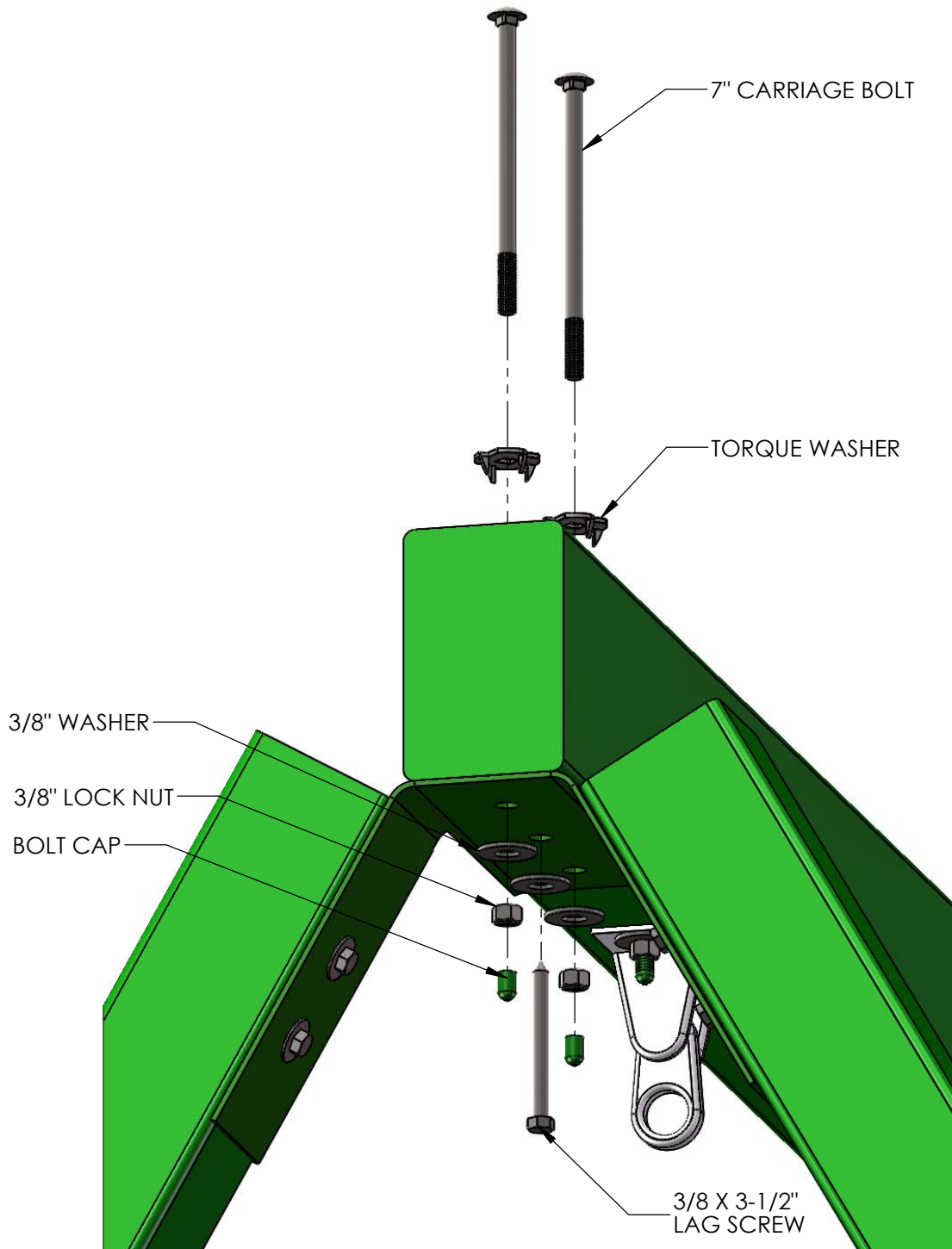

STEP 25: MOUNT SWING BEAM ON FORT

*AN EXTRA PERSON IS REQUIRED FOR THIS STEP

- 1: HAVE ONE PERSON WALK THE SWING BEAM OUT TO THE END OF THE FORT FROM INSIDE THE FORT WHILE THE OTHER PERSON CARRIES IT BY THE LEGS.
- 2: LINE UP THE PILOT HOLE ON THE END OF THE SWING BEAM WITH THE MIDDLE HOLE ON THE SWING BEAM PLATE.
- 3: FASTEN THE SWING BEAM TO THE SWING BEAM PLATE AND SWING BEAM SUPPORT USING A 9" CARRIAGE BOLT WITH A TORQUE WASHER ON TOP AND A 3/8" LOCK NUT AND WASHER ON THE BOTTOM. PLACE GREEN BOLT CAPS OVER EXPOSED THREADS AFTER SECURING.
- 4: FASTEN THE SWING BEAM TO THE SWING BEAM PLATE FROM UNDERNEATH WITH A 3/8 X 3-1/2" LAG SCREW AND A 3/8" WASHER.
- 5: IF NECESSARY USE VISE GRIPS TO HOLD CARRIAGE BOLT IN PLACE WHEN INSTALLING.

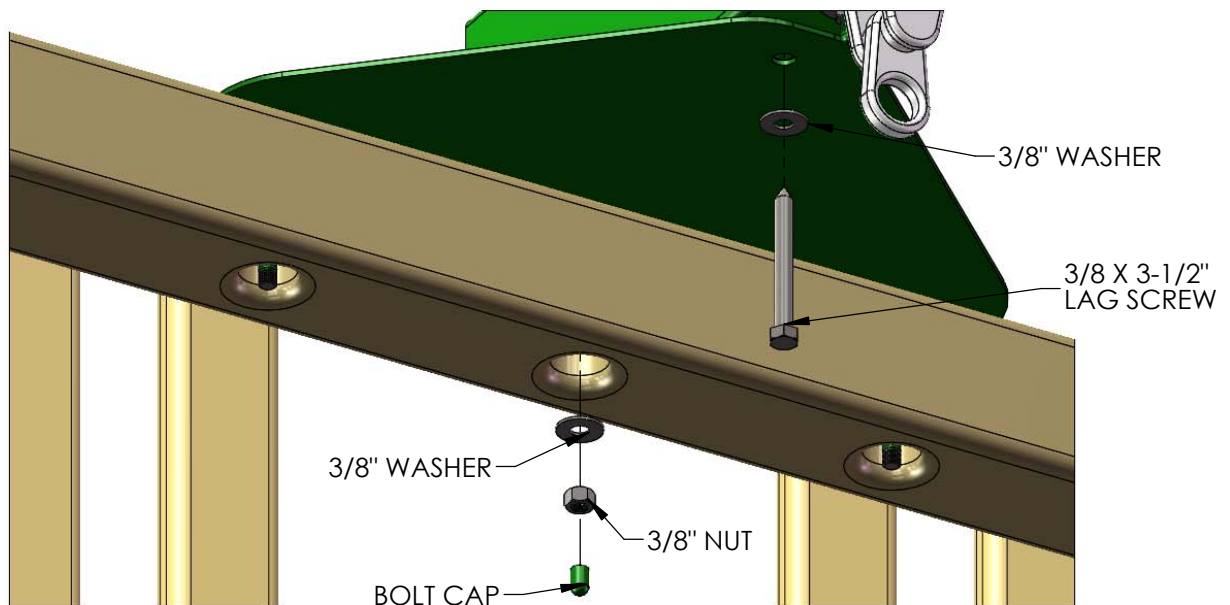
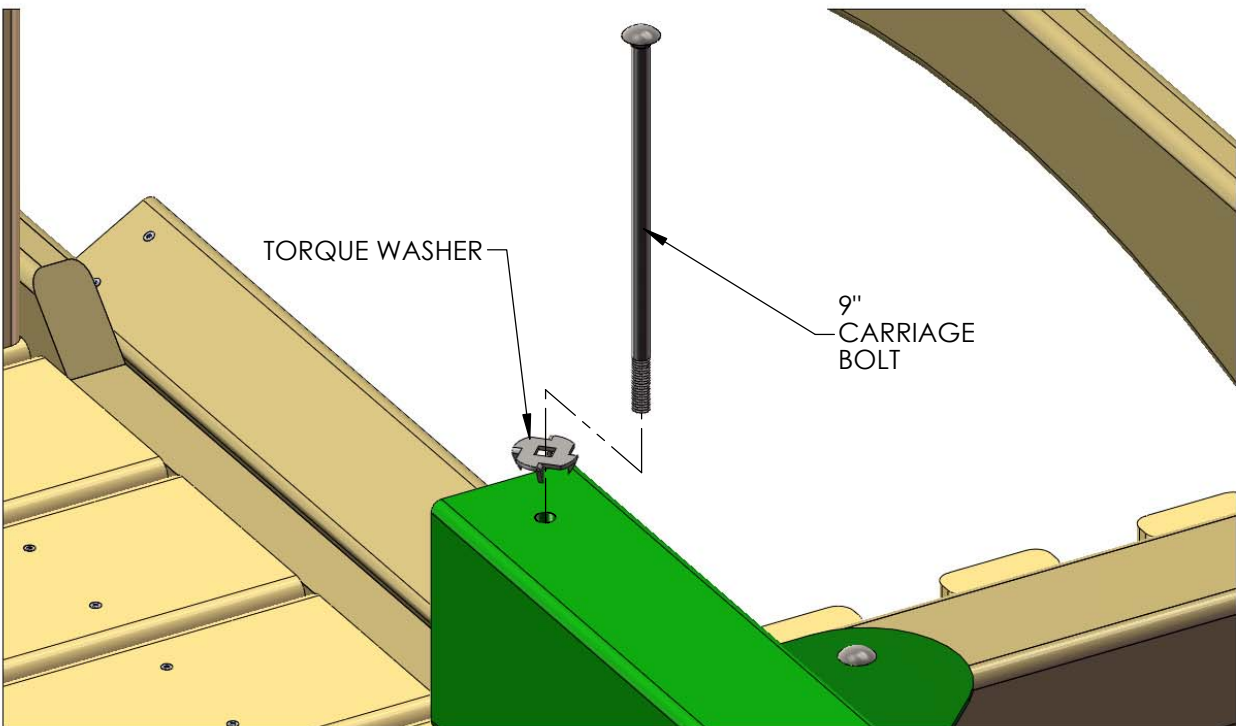

STEP 26: LEVEL SWING BEAM

1: PLACE A LEVEL ON TOP OF THE SWING BEAM AND ADJUST THE BEAM LEGS IN OR OUT AS NEEDED TO MAKE THE SWING BEAM LEVEL.

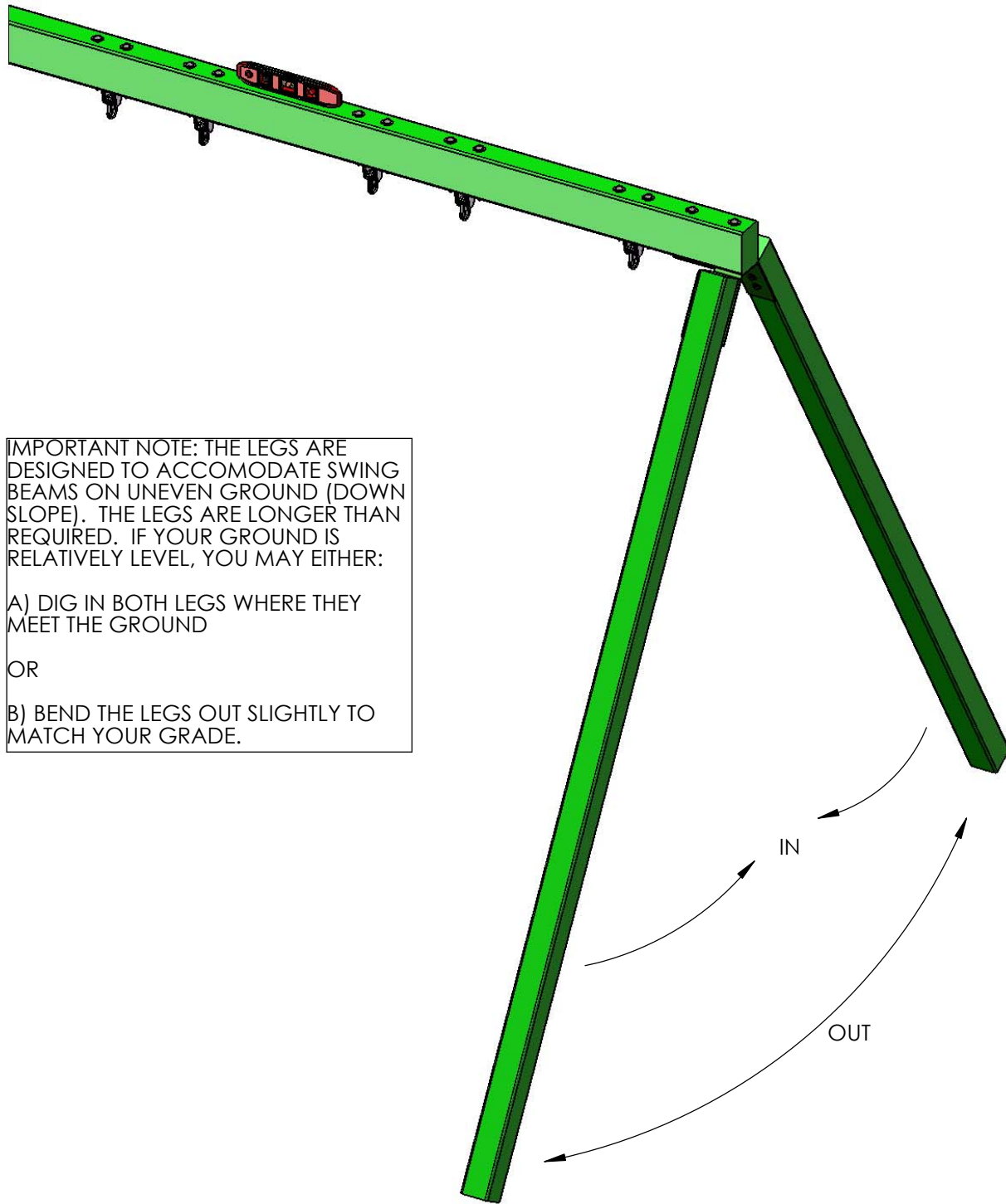

IMPORTANT NOTE: THE LEGS ARE DESIGNED TO ACCOMODATE SWING BEAMS ON UNEVEN GROUND (DOWN SLOPE). THE LEGS ARE LONGER THAN REQUIRED. IF YOUR GROUND IS RELATIVELY LEVEL, YOU MAY EITHER:

A) DIG IN BOTH LEGS WHERE THEY MEET THE GROUND

OR

B) BEND THE LEGS OUT SLIGHTLY TO MATCH YOUR GRADE.

STEP 27: SWING LEG CROSS-MEMBER

- 1: POSITION THE 2 X 4 X 58" SWING LEG CROSS-MEMBER AGAINST THE SWING BEAM LEGS.
- 2: LEVEL CROSS-MEMBER AND MARK THE LOCATION OF THE SECURING HOLES INSIDE THE CROSS-MEMBER HOLES.
- 3: USE 3/8 X 3-1/2" LAG SCREWS WITH 3/8" WASHERS TO SECURE THE CROSS-MEMBER TO THE SWING BEAM LEGS.

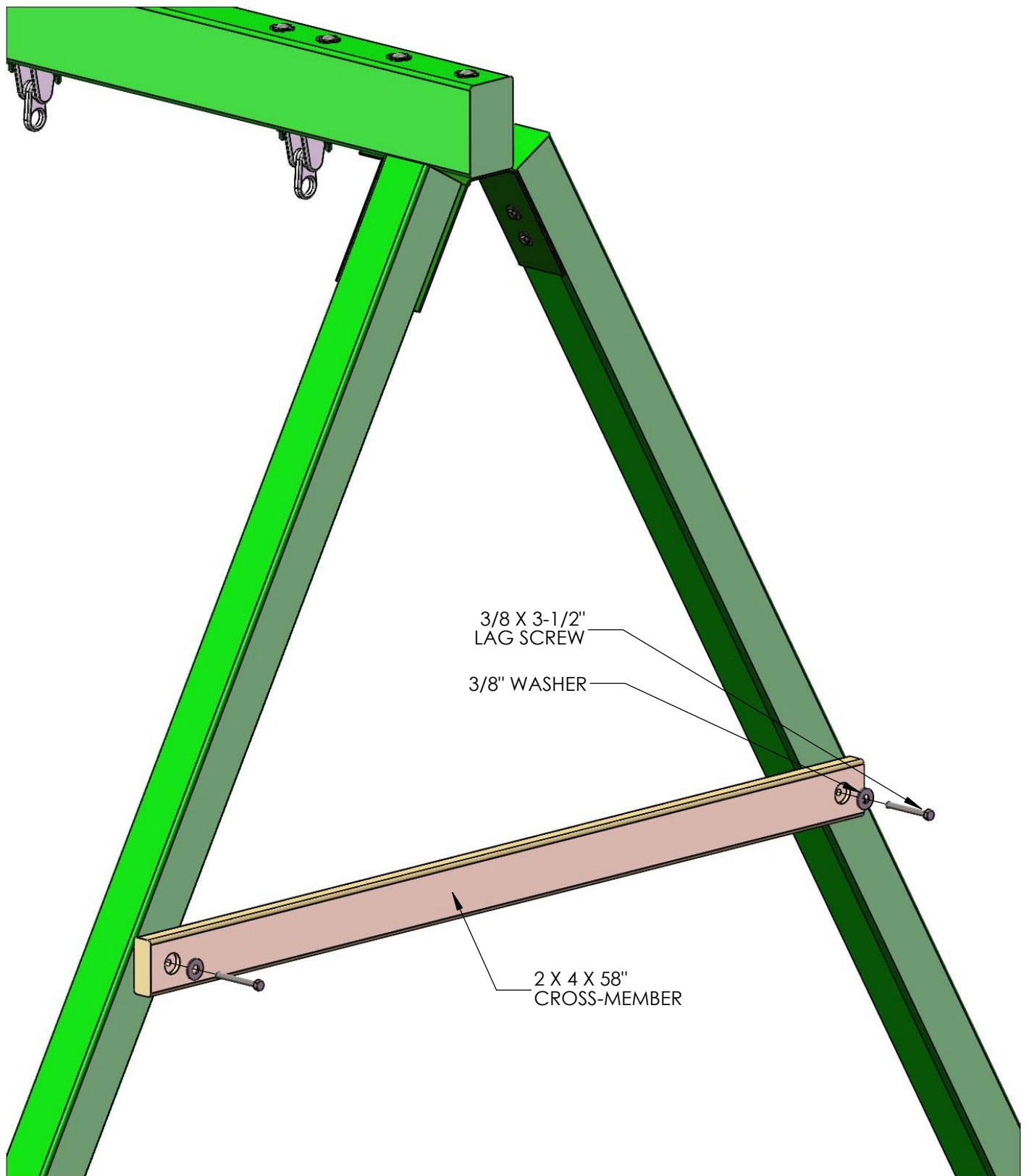

STEP 28: ROOF SUPPORTS

1: WITH OFFSET HOLES DOWN, ATTACH THE 2 X 4 X 35.15" ROOF SUPPORTS TO THE FORT WITH 5/16 X 4-1/2" HEX BOLTS. THE ROOF SUPPORTS SHOULD MEET IN THE MIDDLE TO FORM A RIGHT ANGLE.

2: CONNECT THE ENDS WITH A 2-1/2" WOOD SCREW.

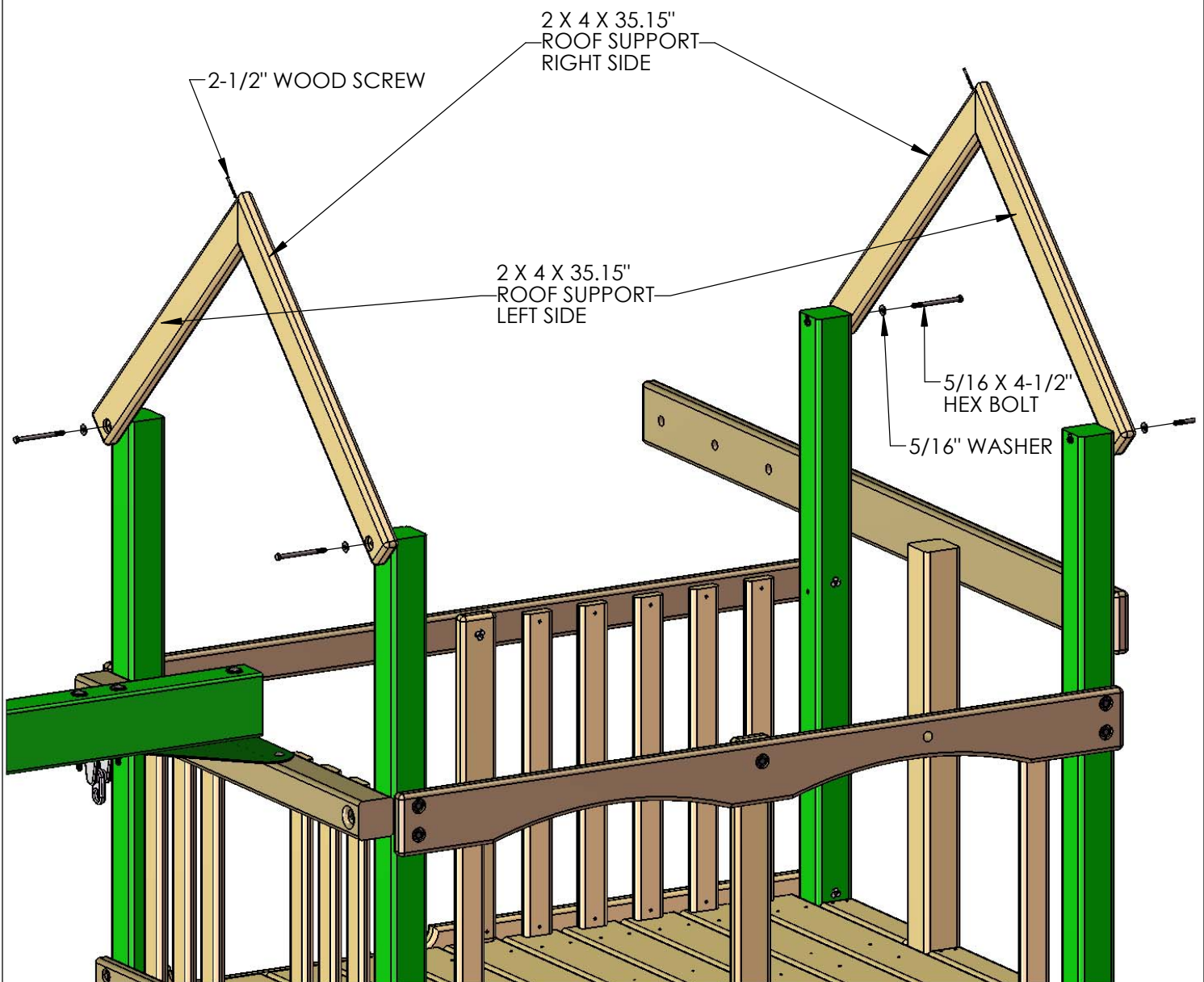

STEP 29: ROOF PEAK SUPPORT

1: PLACE THE 5/4 X 6 X 10" ROOF PEAK SUPPORT AGAINST THE ANGLED ROOF SUPPORTS AND FLUSH TO THE SIDES OF THE ANGLED ROOF SUPPORTS. FASTEN THE ROOF PEAK SUPPORT TO THE ANGLED ROOF SUPPORTS WITH 2" WOOD SCREWS. REPEAT ON OTHER SIDE.

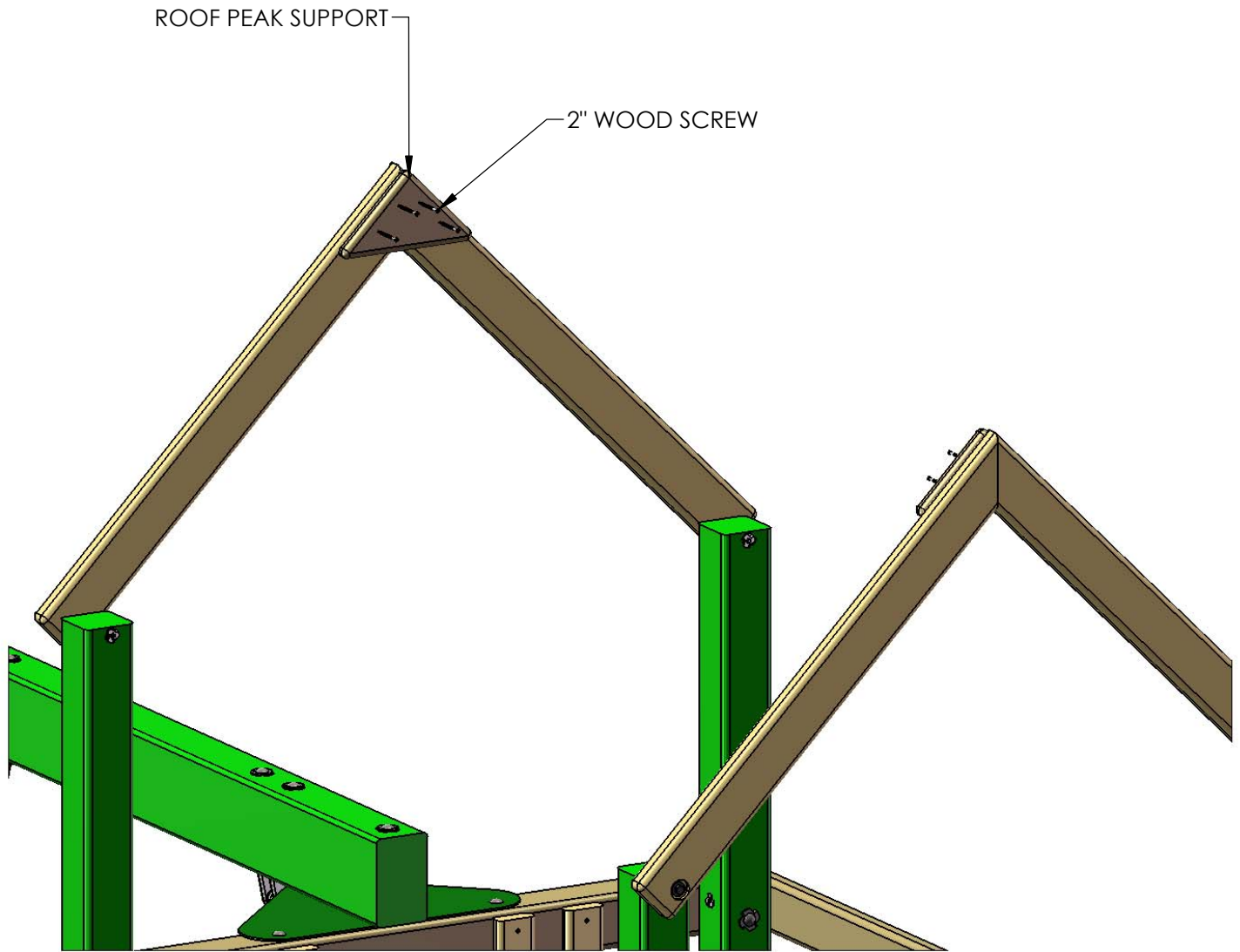

STEP 30: ROOF STARTER REAR

1: PLACE THE 1 X 4 X 76-7/8" ROOF STARTER REAR AT THE PEAK OF THE ROOF. THE HOLES IN THE ROOF STARTER SHOULD BE CENTERED ON THE ROOF SUPPORTS, AND THE FLAT TOP END OF THE ROOF STARTER SHOULD BE PLACED FLUSHED TO THE PEAK OF THE ROOF SUPPORT.

2: FASTEN THE ROOF STARTER TO THE ROOF SUPPORTS WITH 1-1/2" WOOD SCREWS.

MEASURE DIM A ACROSS THE BOTTOM OF THE ROOF SUPPORTS NEAR THE CORNER POSTS. WHEN ATTACHING THE ROOF STARTER DIM B AT THE ROOF PEAK SHOULD MATCH DIM A. THIS WILL MAKE THE ROOF SUPPORTS PARALLEL TO EACH OTHER. DUE TO WOOD MILLING VARIATIONS YOUR HOLES IN THE ROOF STARTER WILL EITHER BE CENTERED ON THE ROOF SUPPORTS OR THEY WILL BE OFFSET TOWARDS THE INSIDE OF THE ROOF SUPPORTS SLIGHTLY. SUBTRACT DIM A FROM 76-7/8" AND THEN DIVIDE THIS NUMBER BY 2. THIS WILL GIVE YOU THE OVERHANG FOR EACH SIDE. USE THE OVERHANG NUMBER ON EACH SIDE TO KEEP YOUR ROOF SUPPORTS PARALLEL.

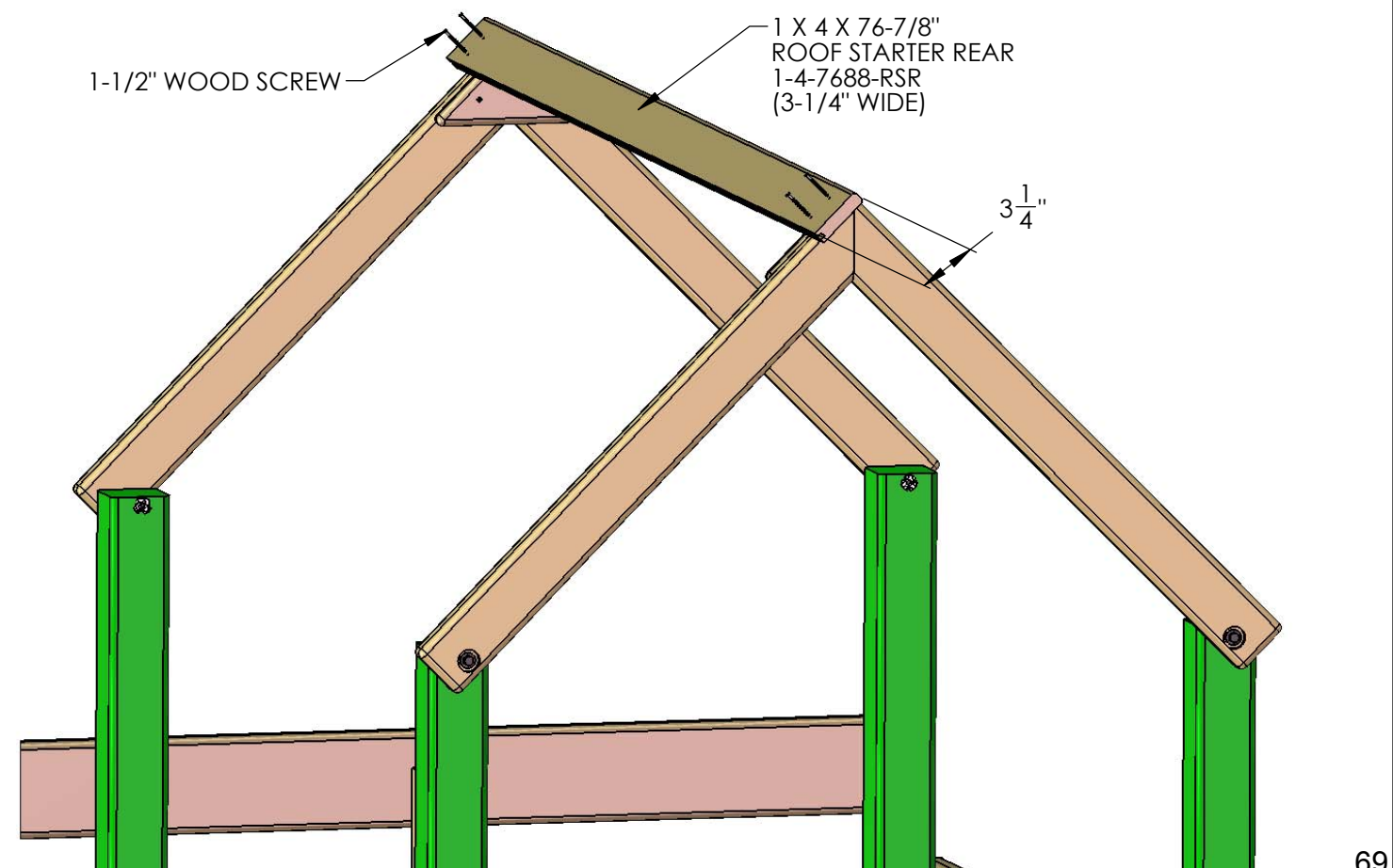
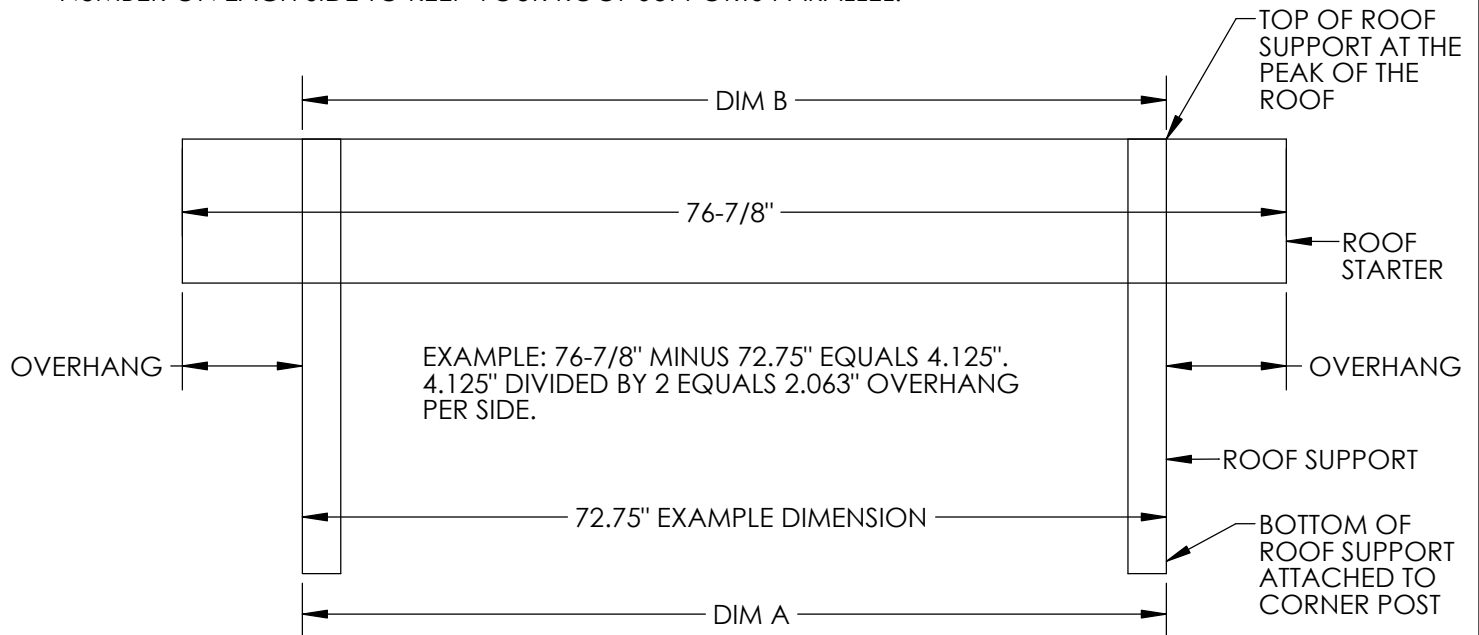

STEP 31: ROOF REAR SECTION AND CHIMNEY

1: PLACE THE 1 X 5 X 76-7/8" ROOF BOARDS ON TOP OF THE ROOF SUPPORTS, FITTING THE TONGUE END INTO THE GROOVE END OF THE ROOF STARTER REAR. THIS SIDE OF THE ROOF GETS SEVEN ROOF BOARDS.

2: FASTEN THE ROOF BOARDS TO THE ROOF SUPPORTS WITH 1-1/2" WOOD SCREWS.

3: PLACE THE 1 X 4 X 76-7/8" ROOF FINISHER AT THE END OF THE ROOF ASSEMBLY, AND FASTEN WITH 1-1/2" WOOD SCREWS.

4: MOUNT THE 2 X 4 X 69-3/4" ROOF FINISHER SUPPORT UNDERNEATH THE ROOF UP AGAINST THE ROOF FINISHER REAR AND ATTACH TO THE REAR CORNER POST USING 5/16" LAG SCREWS AND 5/16" WASHERS.

TIP: USE THE INSTRUCTIONS PROVIDED IN THE APPENDIX TO BUILD THE CHIMNEY. INSTALL THREE ROOF BOARDS AND INSTALL THE CHIMNEY ACCORDING TO THE CHIMNEY INSTRUCTIONS.

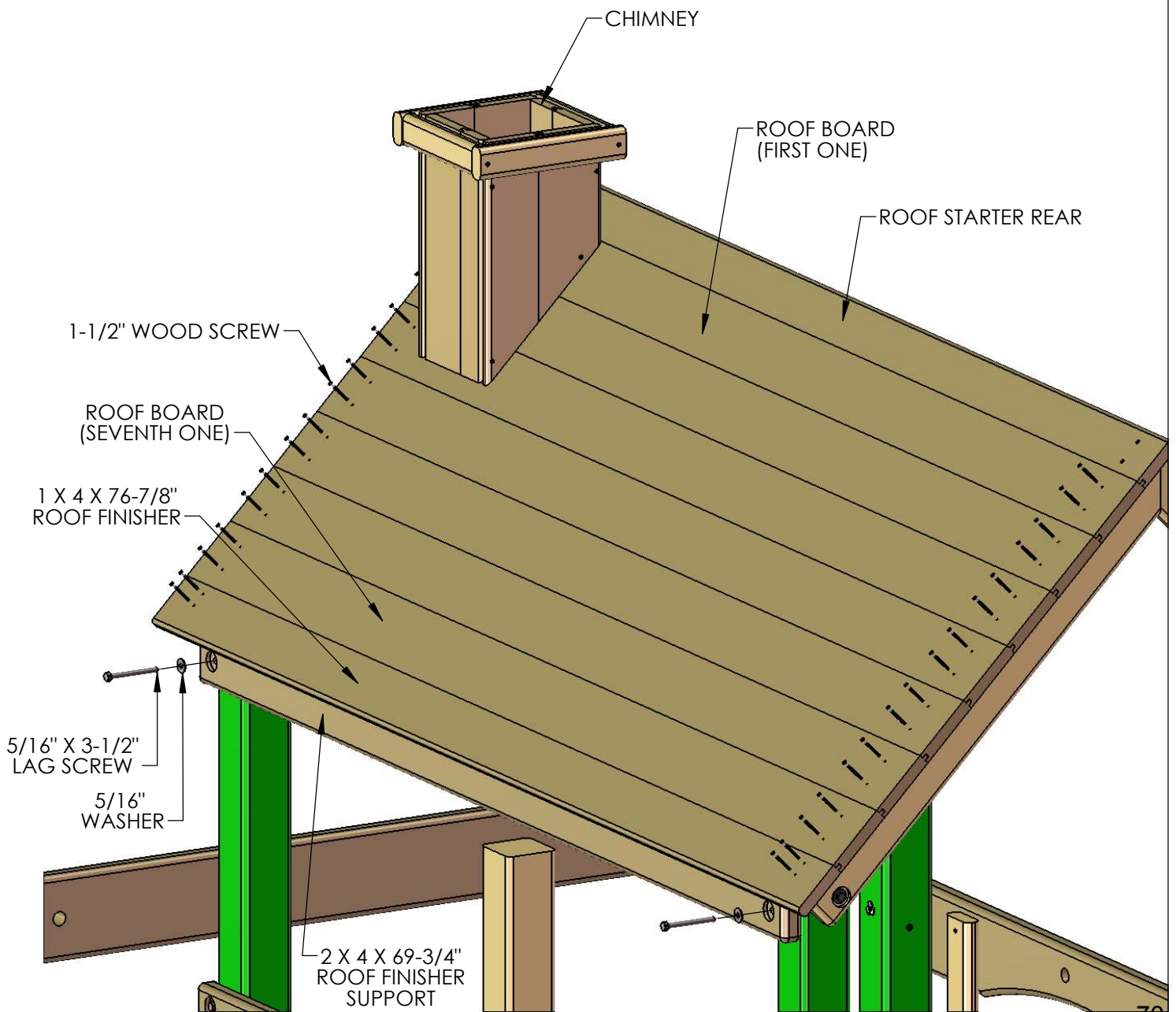

STEP 32: ROOF FRONT SECTION

1: PLACE THE 1 X 4 X 76-7/8" ROOF STARTER FRONT BOARD AT THE PEAK OF THE ROOF OVERLAPPING THE ROOF STARTER REAR. THE HOLES IN THE ROOF STARTER FRONT SHOULD BE CENTERED ON THE ROOF SUPPORTS, AND THE FLAT TOP END OF THE ROOF STARTER FRONT SHOULD BE PLACED FLUSH TO THE TOP EDGE OF THE ROOF STARTER REAR.

2: FASTEN THE ROOF STARTER FRONT TO THE ROOF SUPPORTS WITH 1-1/2" WOOD SCREWS.

3: PLACE THE 1 X 5 X 76-7/8" ROOF BOARDS ON TOP OF THE ROOF SUPPORTS, FITTING THE TONGUE END INTO THE GROOVE END OF THE ROOF STARTER REAR. THIS SIDE OF THE ROOF GETS SEVEN ROOF BOARDS.

4: FASTEN THE ROOF BOARDS TO THE ROOF SUPPORTS WITH 1-1/2" WOOD SCREWS.

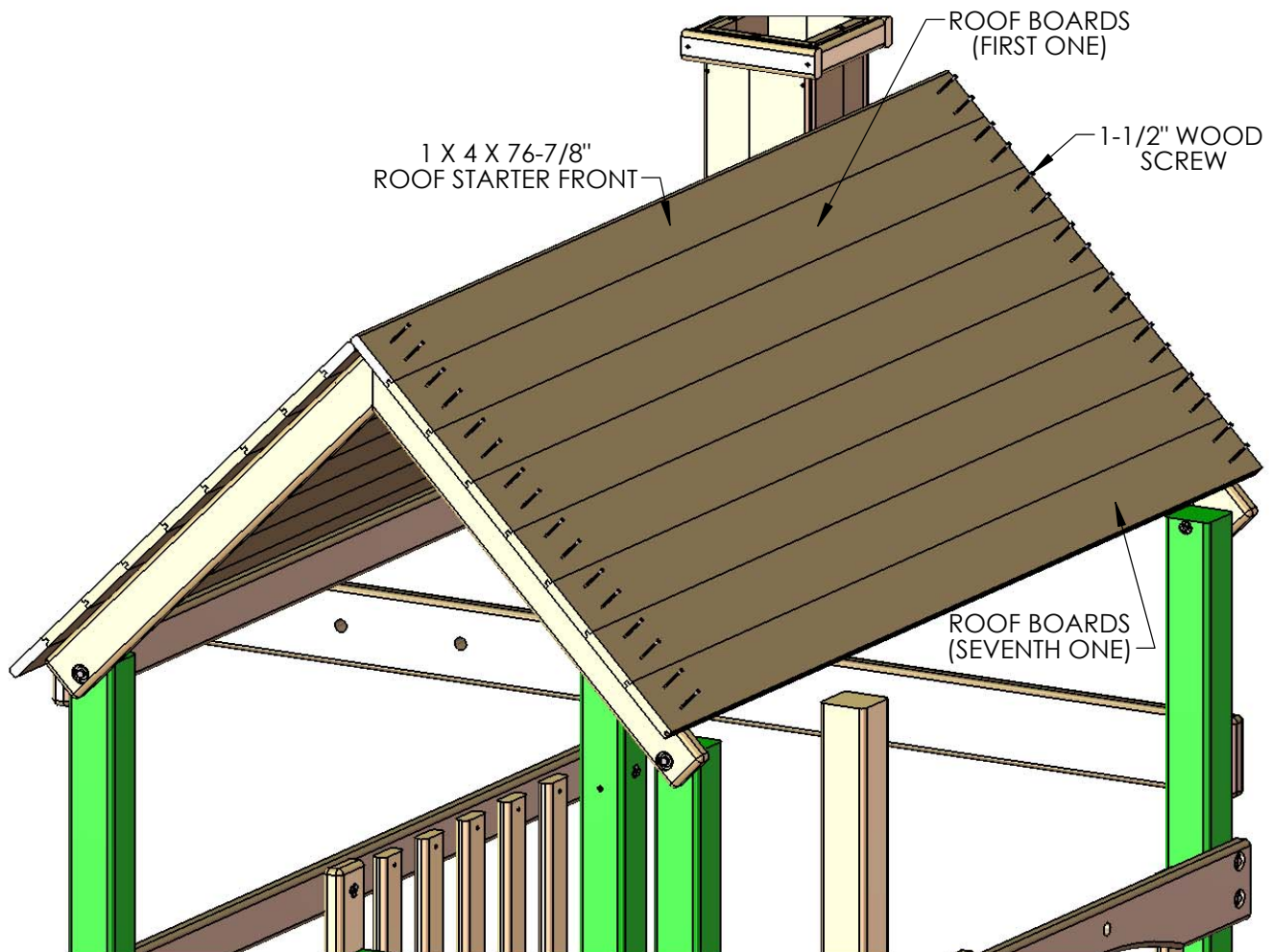
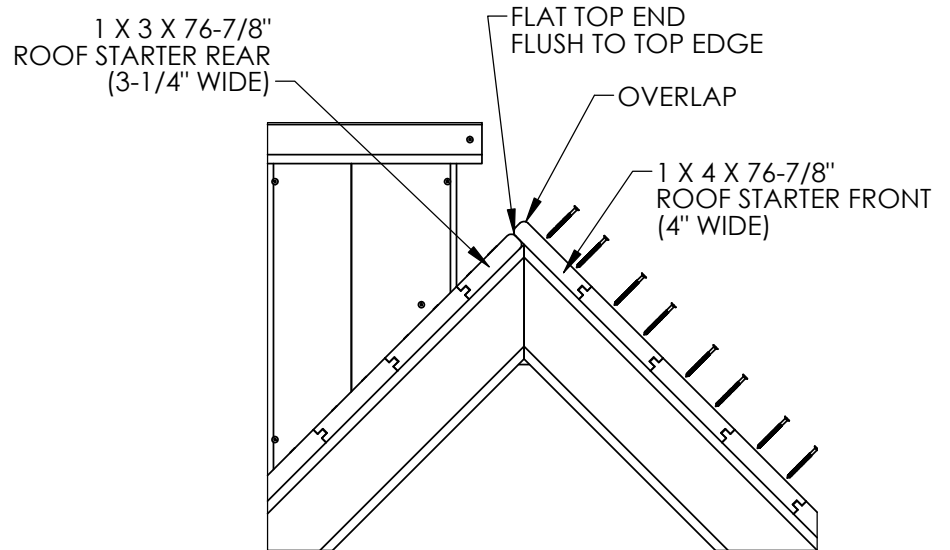

STEP 33: DORMERS

1: USE THE INSTRUCTIONS PROVIDED IN THE APPENDIX TO BUILD THE DORMERS. AFTER INSTALLING THE SEVENTH ROOF BOARD INSTALL THE DORMER MOUNTING BLOCK 9-3/4" FROM THE SIDE EDGE OF THE ROOF TO THE SIDE EDGE OF THE DORMER MOUNTING BLOCK, AND 15" FROM THE BOTTOM OF THE SEVENTH ROOF BOARD TO THE TOP EDGE OF THE DORMER MOUNTING BLOCK. INSERT TWO #8 X 2" WOOD SCREWS THROUGH THE MOUNTING BLOCK INTO THE ROOF BOARD.

2: MOUNT THE DORMER ON TOP OF THE ROOF, 4-1/2" FROM THE BOTTOM EDGE OF THE SEVENTH ROOF BOARD TO THE BOTTOM EDGE OF THE DORMER, THE DORMER MOUNTING BLOCK SHOULD BE IN BETWEEN THE WALLS OF THE DORMER. MAKE SURE THE DORMER IS HORIZONTALLY PARALLEL TO THE ROOF BOARDS AND FULLY RESTING ON TOP OF THE ROOF. THE PRE-DRILLED HOLES ON EACH SIDE OF THE DORMER SHOULD BE CENTERED WITH THE DORMER MOUNTING BLOCK. INSERT ONE #8 X 1-1/2" WOOD SCREW THROUGH EACH HOLE ON BOTH SIDES INTO THE DORMER MOUNTING BLOCK.

3: REPEAT SUB-STEP 1 TO 2 FOR THE OTHER DORMER.

4: INSTALL TWO 2" SCREWS FROM UNDERNEATH THE ROOF INTO THE DORMER MOUNTING BLOCKS.

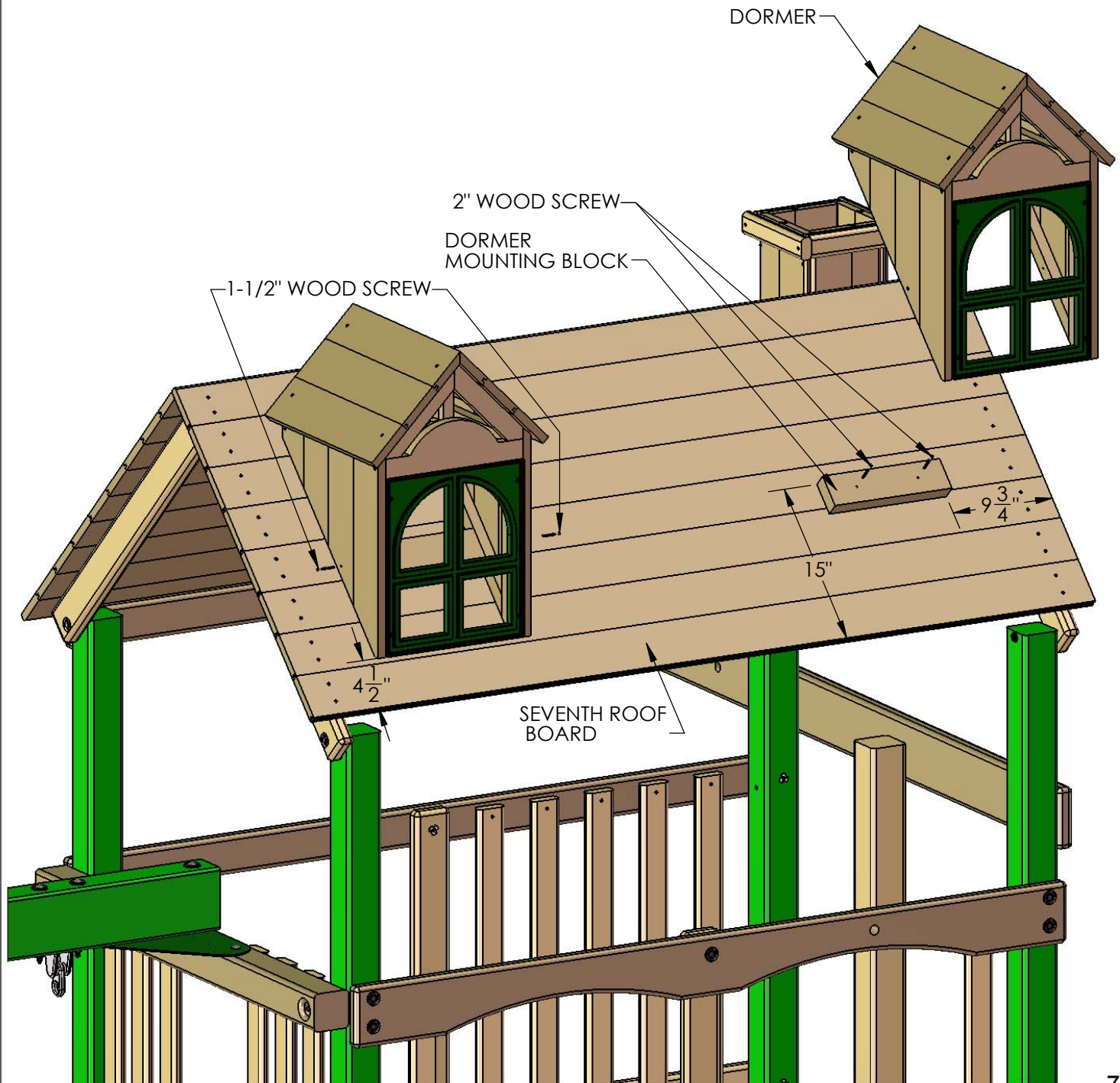

STEP 34: FRONT GABLE ASSEMBLY

1: FIND ONE 5 X 11 X 46.97" ROOF PANEL LEFT ASSEMBLY, ONE 5 X 11 X 46.97" ROOF PANEL RIGHT ASSEMBLY, ONE 5/4 X 5 X 10.81 ROOF PANEL PEAK SUPPORT AND A FRONT PLASTIC ARCH.

2: PLACE THE ROOF PANEL ASSEMBLIES ON A FLAT SURFACE WITH THE COUNTERSUNK HOLES FACING UP, ALIGN THE ANGLED ENDS OF THE ROOF PANEL ASSEMBLIES FLUSH AT THE PEAK AND LEAVING A GAP AT THE BOTTOM OF THE SEAM, THIS PROVIDES YOU FREEDOM FOR ADJUSTABILITY.

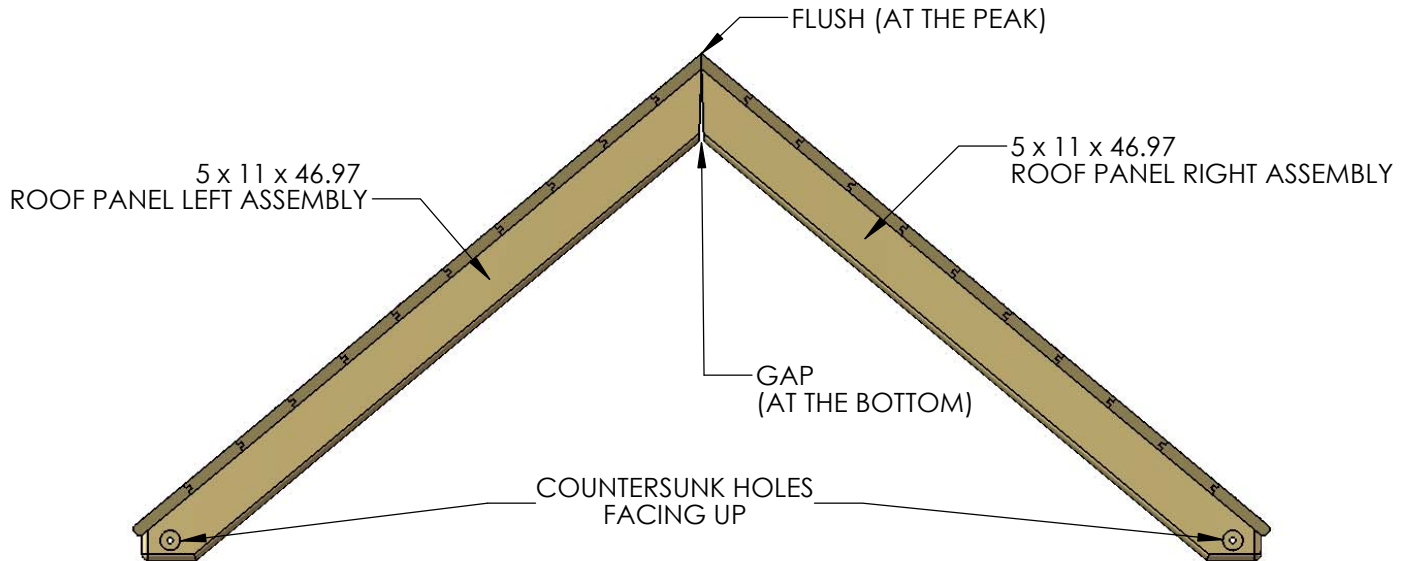

3: PLACE THE FRONT PLASTIC ARCH ON TOP OF THE ROOF SUPPORTS. MAKE SURE TO KEEP THE ROOF PANEL ASSEMBLIES TIGHT AT THE PEAK AND THE FRONT PLASTIC ARCH FLUSH TO THE ROOF OVERHANG ON BOTH SIDES. FASTEN USING #8 X 1-1/4" WOOD SCREWS. THE FINAL ASSEMBLY SHOULD MEASURE 69-7/8" AT THE BOTTOM.

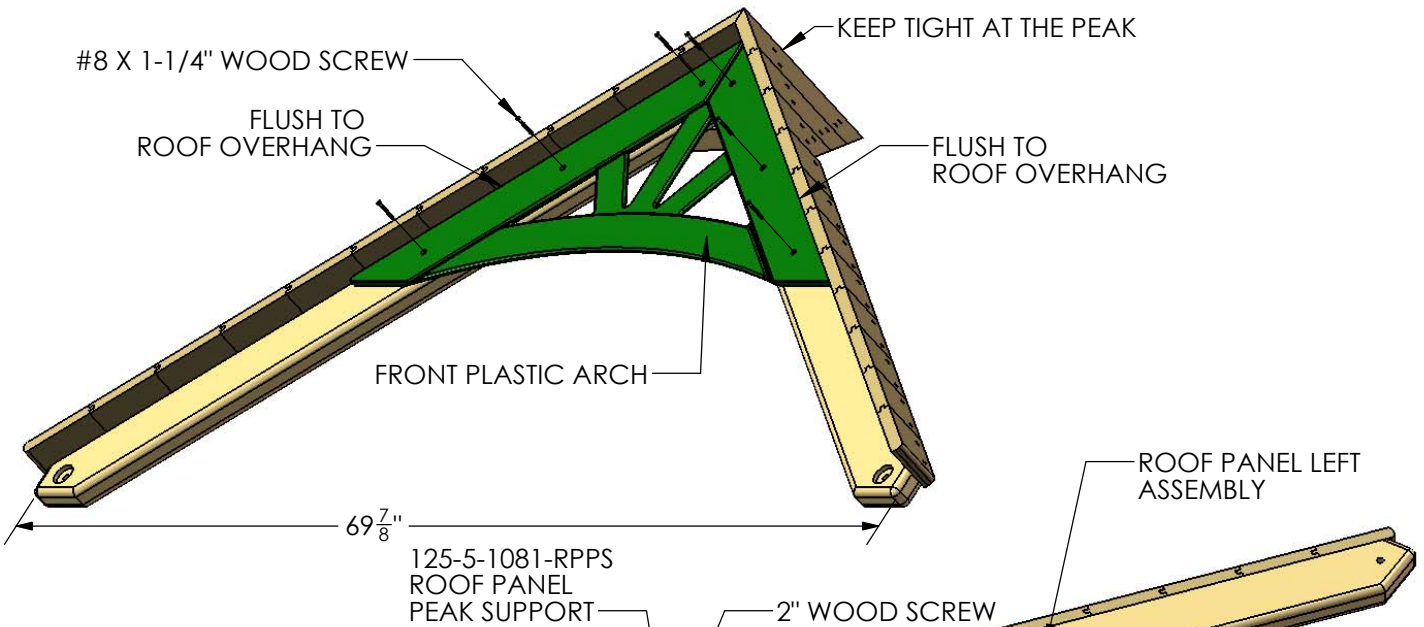

4: PLACE THE ROOF PANEL PEAK SUPPORT ON TOP OF THE TWO PANELS AND FLUSH TO THE SIDES OF THE ROOF BOARD BATTENS. FASTEN THE ROOF PANEL PEAK SUPPORT TO THE ROOF PANELS USING 2" WOOD SCREWS.

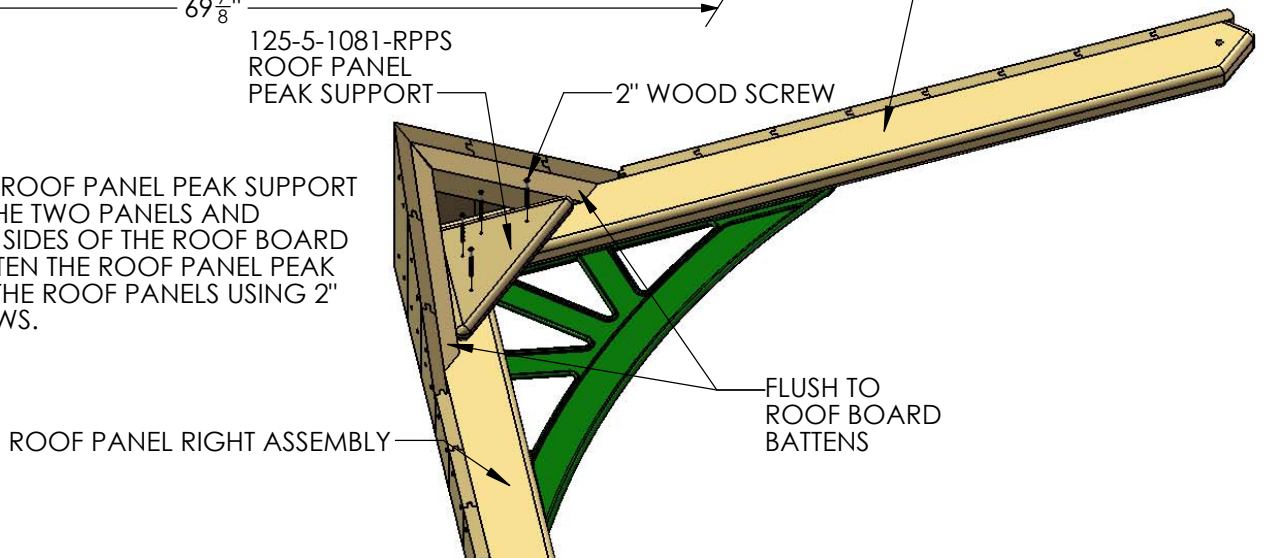

STEP 35: ATTACHING THE FRONT GABLE

1: MOUNT THE GABLE ASSEMBLY RESTING ABOVE THE TOP PANEL BOARD, MAKE SURE THE GABLE ASSEMBLY IS FLUSH AGAINST THE FRONT CORNER POSTS. THE GABLE ROOF PEAK SHOULD BE RESTING ON TOP OF THE ROOF FRONT SECTION.

TIP: MAKE SURE THE DISTANCE BETWEEN THE GABLE ASSEMBLY AND THE ROOF OVERHANG IS EQUAL ON BOTH SIDES. IT IS RECOMMENDED TO TEST FIT THE 1 X 4 X 29.29" ROOF FINISHERS FRONT LEFT AND RIGHT TO ASSURE THIS EQUAL DISTANCE (DO NOT FASTEN). IF NECESSARY SLIDE THE GABLE ASSEMBLY LEFT OR RIGHT UNTIL FINAL POSITION IS ACCOMPLISHED.

2: THE GABLE ASSEMBLY BOTTOM COUNTERSUNK HOLES WILL REMAIN EMPTY FOR NOW.

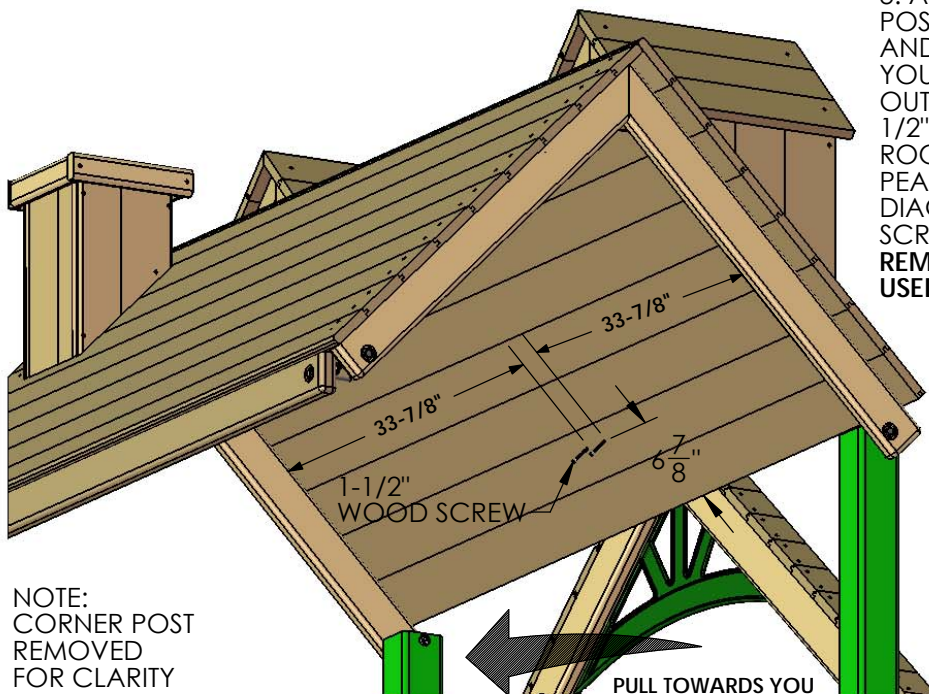
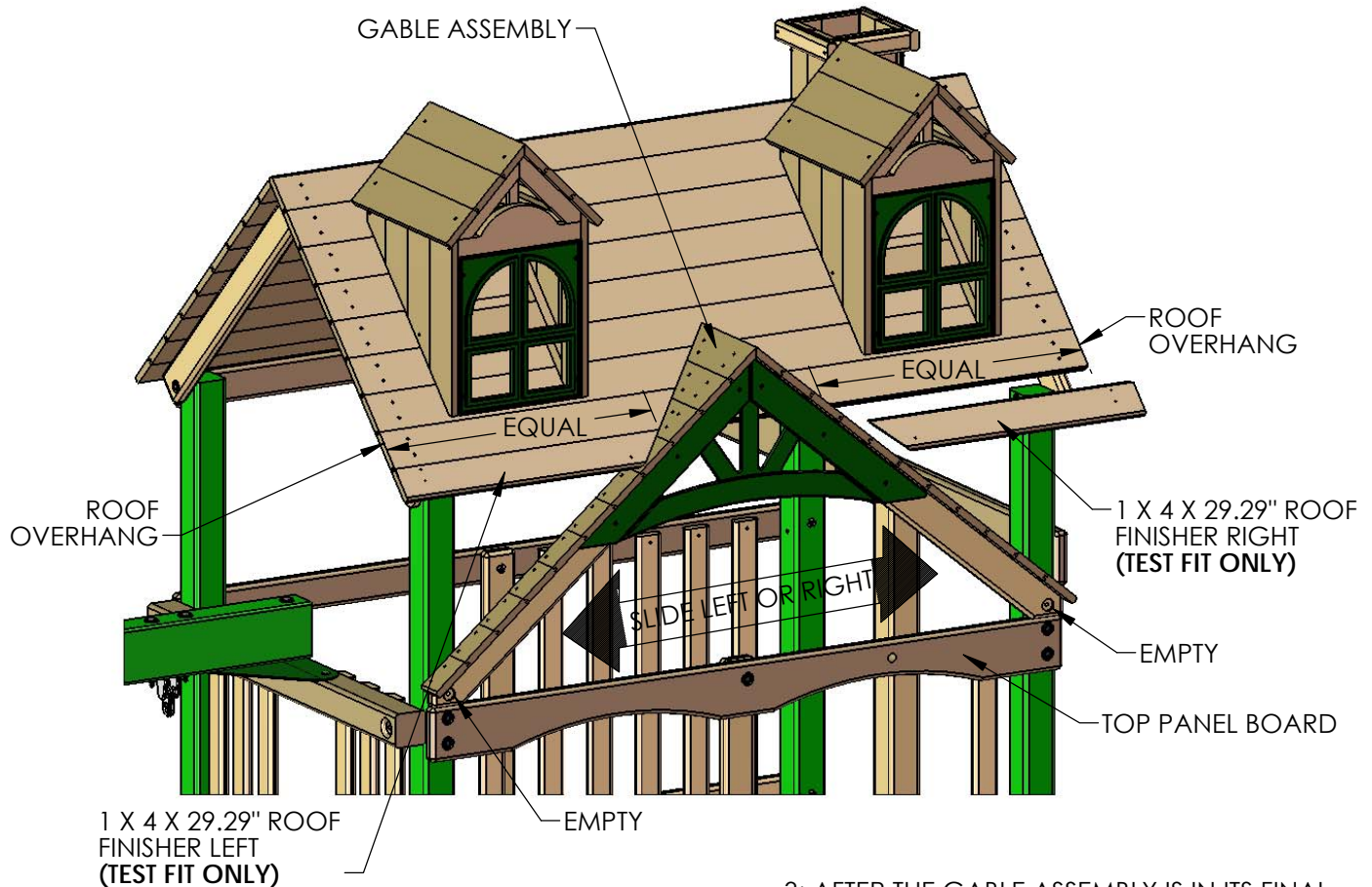

3: AFTER THE GABLE ASSEMBLY IS IN ITS FINAL POSITION. GO INSIDE ON TOP OF THE DECK AND PULL THE GABLE ASSEMBLY TOWARDS YOU MAKING SURE IT IS FLUSH TO THE OUTSIDE OF THE ROOF AND INSERT TWO 1-1/2" WOOD SCREWS FROM UNDERNEATH THE ROOF INTO THE GABLE ASSEMBLY ROOF PEAK. USE THE DIMENSIONS SHOWN IN THE DIAGRAM TO THE LEFT TO INSERT THE WOOD SCREWS IN THE CORRECT LOCATION. REMOVE THE ROOF FINISHERS, THESE WILL BE USED IN A LATER STEP.

NOTE:
CORNER POST
REMOVED
FOR CLARITY

STEP 36: WALL PANEL SUPPORTS

1: PLACE THE 2 X 4 X 22.75" WALL PANEL SUPPORT LEFT ANGLED END ON TOP OF THE GABLE ASSEMBLY LEFT SIDE AND THE OPPOSITE END WITH THE COUNTERSUNK HOLE FLUSH AGAINST THE LEFT FRONT CORNER POST. MAKE SURE THE ANGLED END OF THE WALL PANEL SUPPORT IS FLUSH TO THE INSIDE OF THE GABLE ASSEMBLY. THE WALL PANEL SUPPORT TOP EDGE MUST BE PARALLEL AT 21-7/8" TO THE TOP EDGE OF THE TOP PANEL BOARD. ATTACH THE WALL PANEL SUPPORT LEFT TO THE GABLE ASSEMBLY WITH ONE #8 X 2-1/2" WOOD SCREW.

2: THE COUNTERSUNK HOLE WILL REMAIN EMPTY FOR NOW.

3: REPEAT SUB-STEPS 1 & 2 FOR THE OPPOSITE SIDE.

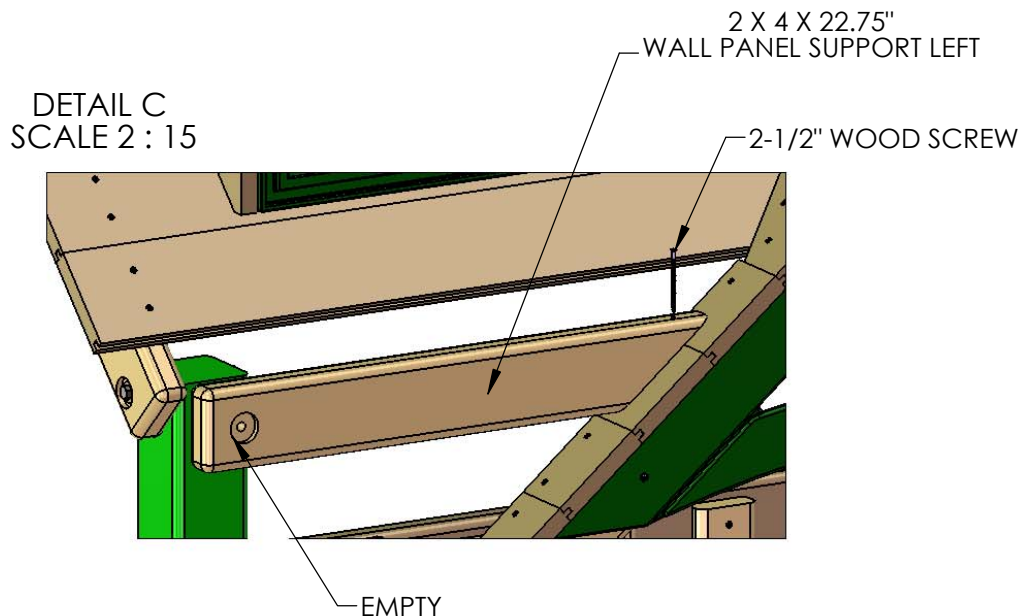

STEP 37: ROOF FINISHERS FRONT

1: PLACE THE 1 X 4 X 29.29" ROOF FINISHER FRONT LEFT ANGLED END ON TOP OF THE GABLE ASSEMBLY LEFT SIDE. PLACE THE 1 X 4 X 29.29" ROOF FINISHER FRONT RIGHT ANGLED END ON TOP OF THE GABLE ASSEMBLY RIGHT SIDE. FIT THE TONGUE END INTO THE GROOVE OF THE ROOF BOARD ABOVE THEM.

2: MAKE SURE THAT BOTH ROOF FINISHERS ENDS ARE FLUSH ON BOTH SIDES OF THE ROOF AND TIGHT TO THE GABLE ASSEMBLY.

TIP: DO THIS ONLY IF "THE ROOF FINISHERS ARE UNEVEN WITH THE OVERHANG". REMOVE THE ROOF FINISHERS SO YOU CAN ACCESS TO THE WOOD SCREWS ATTACHING THE WALL PANEL SUPPORTS. ONCE YOU REMOVED THE WALL PANEL SUPPORTS ON BOTH SIDES, PROCEED TO LOOSEN UP THE WOOD SCREWS ATTACHING THE GABLE ASSEMBLY FROM UNDERNEATH THE ROOF. SLIDE THE GABLE ASSEMBLY LEFT OR RIGHT. TEST FIT THE ROOF FINISHERS ON BOTH SIDES. ONCE THE CORRECT POSITION IS ACCOMPLISHED PROCEED TO RE-ATTACH THE REMOVED PIECES.

3: INSERT 5/16 X 3-1/2" LAG SCREWS AND 5/16" WASHERS INTO THE WALL PANEL SUPPORTS AND GABLE ASSEMBLY COUNTERSUNK HOLES.

4: FASTEN THE ROOF FINISHER FRONT LEFT AND ROOF FINISHER FRONT RIGHT TO THE ROOF SUPPORTS AND TO THE WALL PANEL SUPPORTS WITH #8 X 1-1/2" WOOD SCREWS ON BOTH SIDES OF THE ROOF.

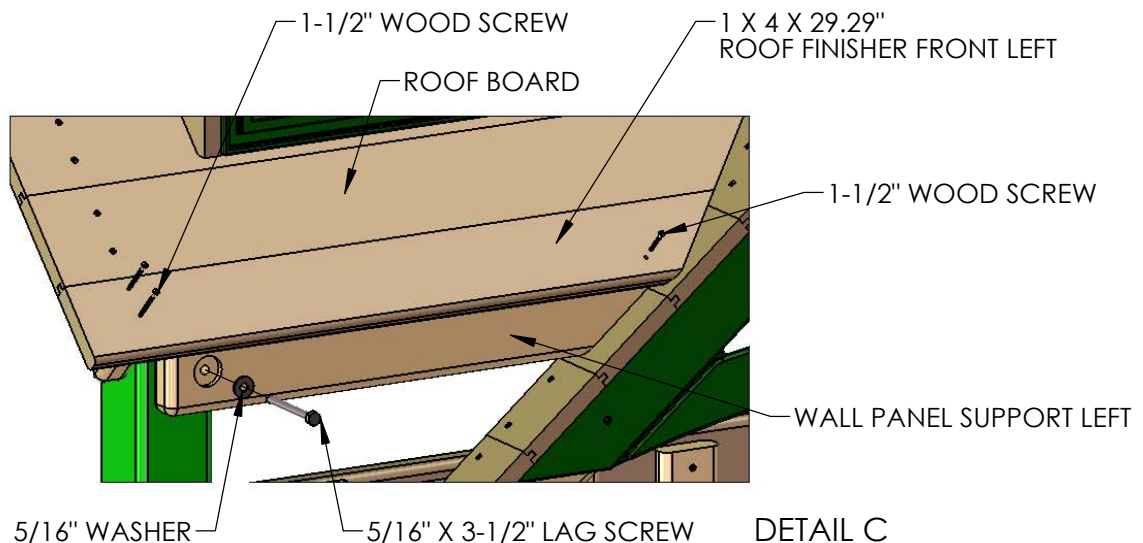
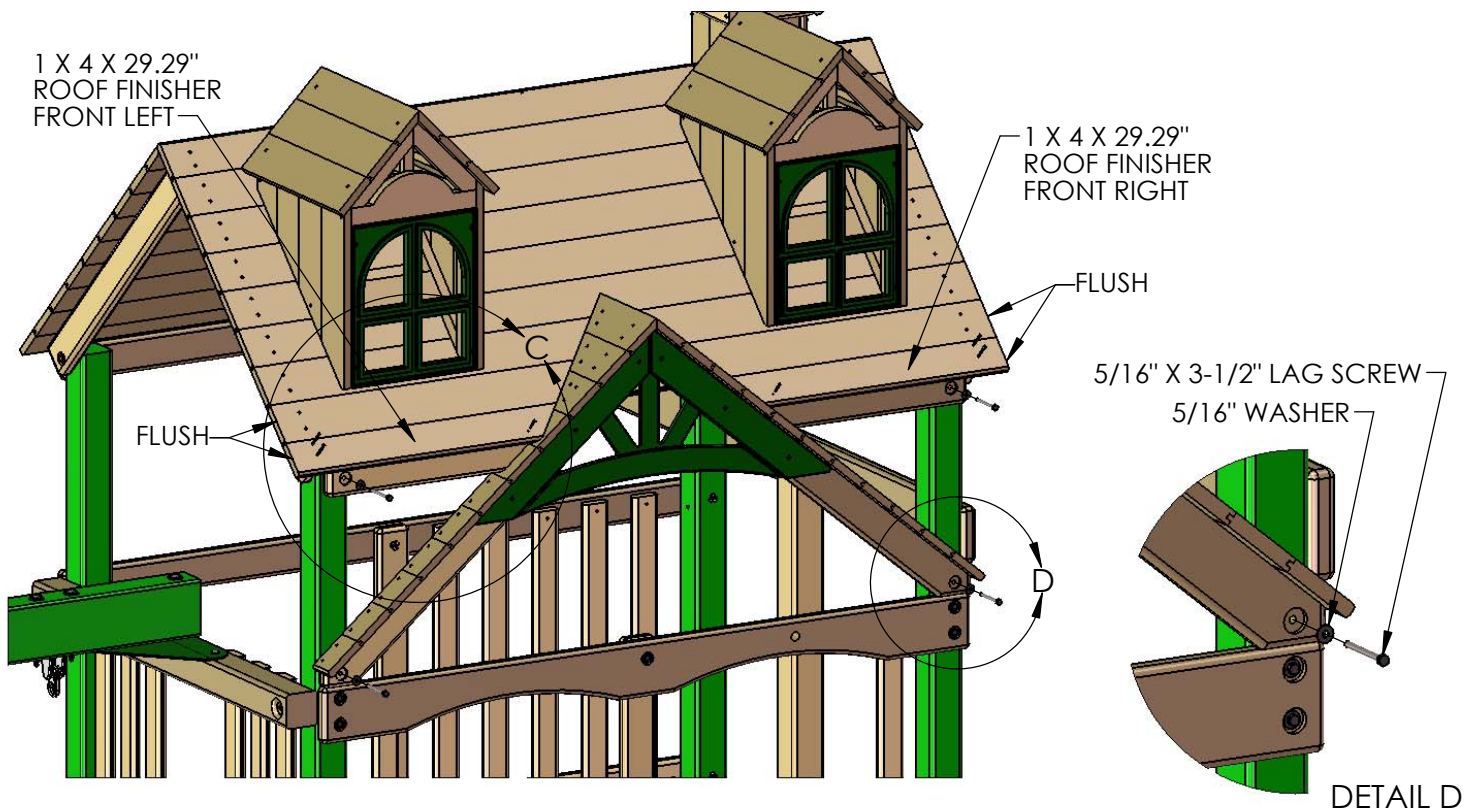

STEP 38: ROOF BATTEN

1: PLACE THE 1 X 2 X 32" ROOF BATTEN UP AGAINST THE ROOF PANEL, CENTERED BETWEEN THE ROOF SUPPORTS, FLUSH THE BOTTOM EDGE OF THE ROOF BATTEN TO THE BOTTOM EDGE OF THE SEVENTH ROOF BOARD, MAKE SURE IT IS PARALLEL TO THE ROOF SUPPORTS. INSERT 1-1/2" WOOD SCREWS THROUGH THE PRE-DRILLED HOLES ALONG THE BATTEN.

2: REPEAT THE PREVIOUS SUB-STEP FOR THE OTHER SIDE.

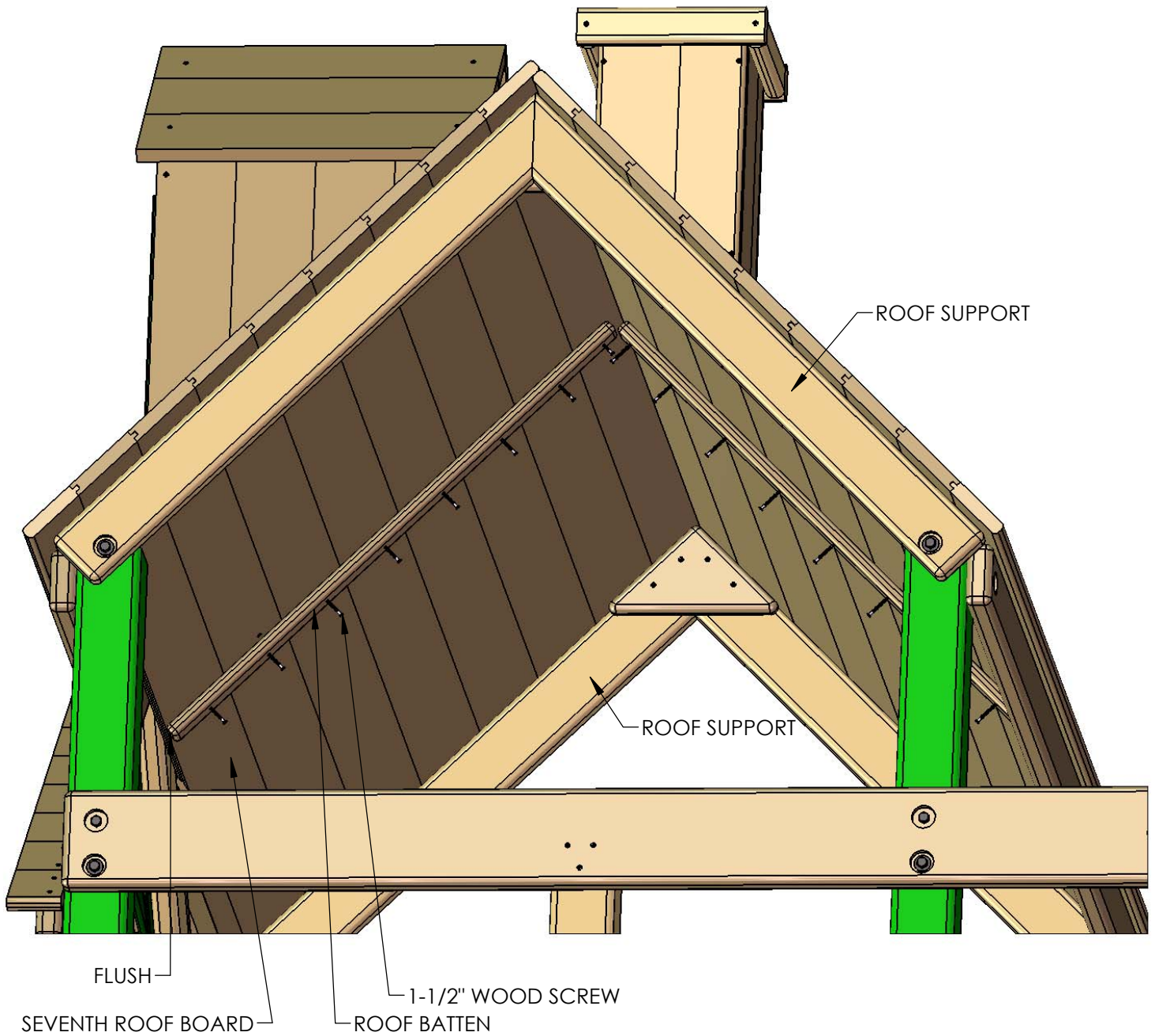

STEP 39: WALL PANEL BOARDS

1: START MOUNTING THE 1 X 4 X 19.31" WALL PANEL BOARD AGAINST THE GABLE LEFT ROOF SUPPORT AND THE WALL PANEL SUPPORT LEFT. THE SIDE EDGE OF THE WALL PANEL BOARD MUST BE PARALLEL AND 1/4" FROM THE SIDE EDGE OF THE FRONT LEFT CORNER POST. THE WALL PANEL BOARD BOTTOM ANGLED END SHOULD BE PARALLEL AND 1" FROM THE SIDE EDGE OF THE GABLE ROOF SUPPORT. FASTEN THE WALL PANEL BOARD WITH FOUR 1-1/2" WOOD SCREWS.

2: MOUNT THE 1 X 4 X 15.75" WALL PANEL BOARD AGAINST THE GABLE LEFT ROOF SUPPORT AND THE WALL PANEL SUPPORT LEFT. THE SIDE EDGE OF THE WALL PANEL BOARD MUST BE PARALLEL AND 1/4" FROM THE SIDE EDGE OF THE PREVIOUS WALL PANEL BOARD. THE WALL PANEL BOARD BOTTOM ANGLED END SHOULD BE PARALLEL AND 1" FROM THE SIDE EDGE OF THE GABLE ROOF SUPPORT. FASTEN THE WALL PANEL BOARD WITH FOUR 1-1/2" WOOD SCREWS.

3: MOUNT THE 1 X 4 X 12.25" WALL PANEL BOARD AGAINST THE GABLE LEFT ROOF SUPPORT AND THE WALL PANEL SUPPORT LEFT. THE SIDE EDGE OF THE WALL PANEL BOARD MUST BE PARALLEL AND 1/4" FROM THE SIDE EDGE OF THE PREVIOUS WALL PANEL BOARD. THE WALL PANEL BOARD BOTTOM ANGLED END SHOULD BE PARALLEL AND 1" FROM THE SIDE EDGE OF THE GABLE ROOF SUPPORT. FASTEN THE WALL PANEL BOARD WITH FOUR 1-1/2" WOOD SCREWS.

4: MOUNT THE 1 X 4 X 8.75" WALL PANEL BOARD AGAINST THE GABLE LEFT ROOF SUPPORT AND THE WALL PANEL SUPPORT LEFT. THE SIDE EDGE OF THE WALL PANEL BOARD MUST BE PARALLEL AND 1/4" FROM THE SIDE EDGE OF THE PREVIOUS WALL PANEL BOARD. THE WALL PANEL BOARD BOTTOM ANGLED END SHOULD BE PARALLEL AND 1" FROM THE SIDE EDGE OF THE GABLE ROOF SUPPORT. FASTEN THE WALL PANEL BOARD WITH FOUR 1-1/2" WOOD SCREWS.

5: REPEAT SUB-STEP 1 TO 4 FOR THE OTHER SIDE.

NOTE:
ROOF BOARDS REMOVED FROM VIEW FOR CLARITY

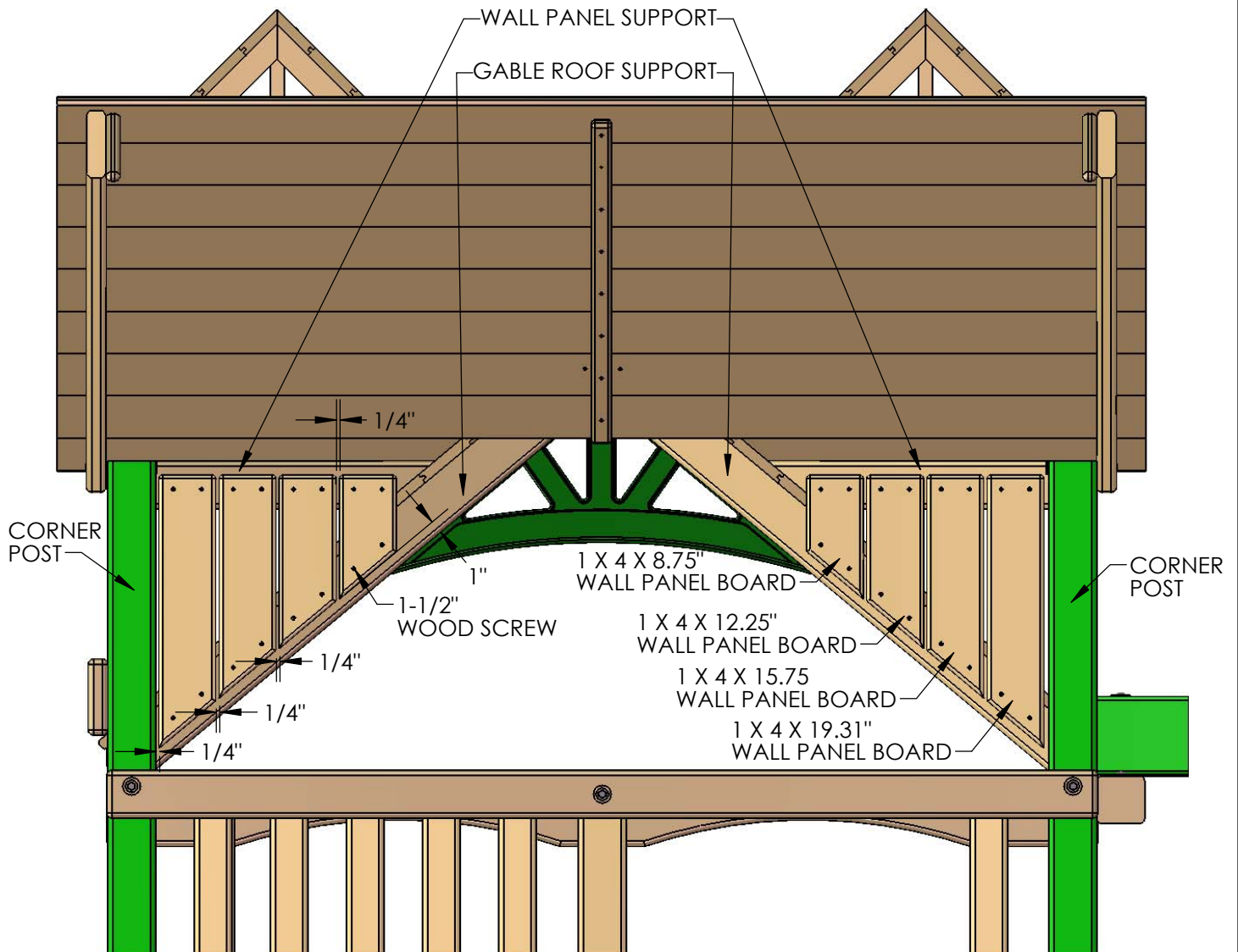

STEP 40: PLASTIC SUNBURST

1: MOUNT THE PLASTIC SUNBEAM TO THE ROOF SUPPORTS ON THE LEFT AND RIGHT SIDE OF THE ROOF, THE PLASTIC SUNBEAM MUST BE UP AGAINST THE OVERHANGING ROOF BOARDS. FASTEN THE PLASTIC SUNBEAM TO THE ROOF SUPPORTS USING TWO #8 X 2-1/2" WOOD SCREWS ON THE TOP AND SIX #8 X 2" WOOD SCREWS ON THE REMAINING HOLES.

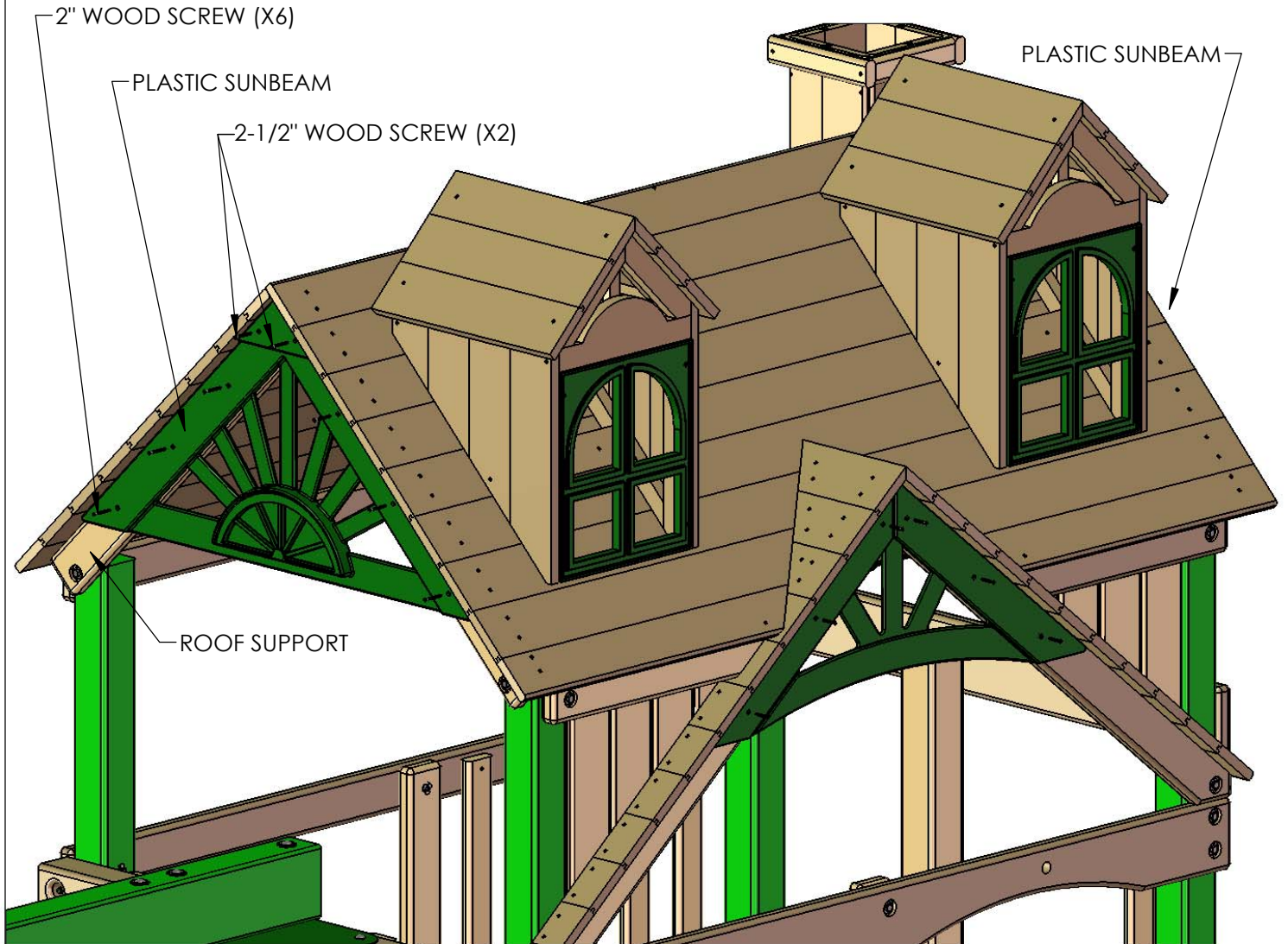

STEP 41: HANGING THE SWINGS

- 1: START BY ATTACHING ONE SPRING CLIP TO EACH IRON DUCTILE ON THE SWING BEAM.
- 2: ATTACH ONE CHAIN PER ACCESSORY TO EACH SPRING CLIP.
- 3: ADJUST HEIGHT AS NEEDED

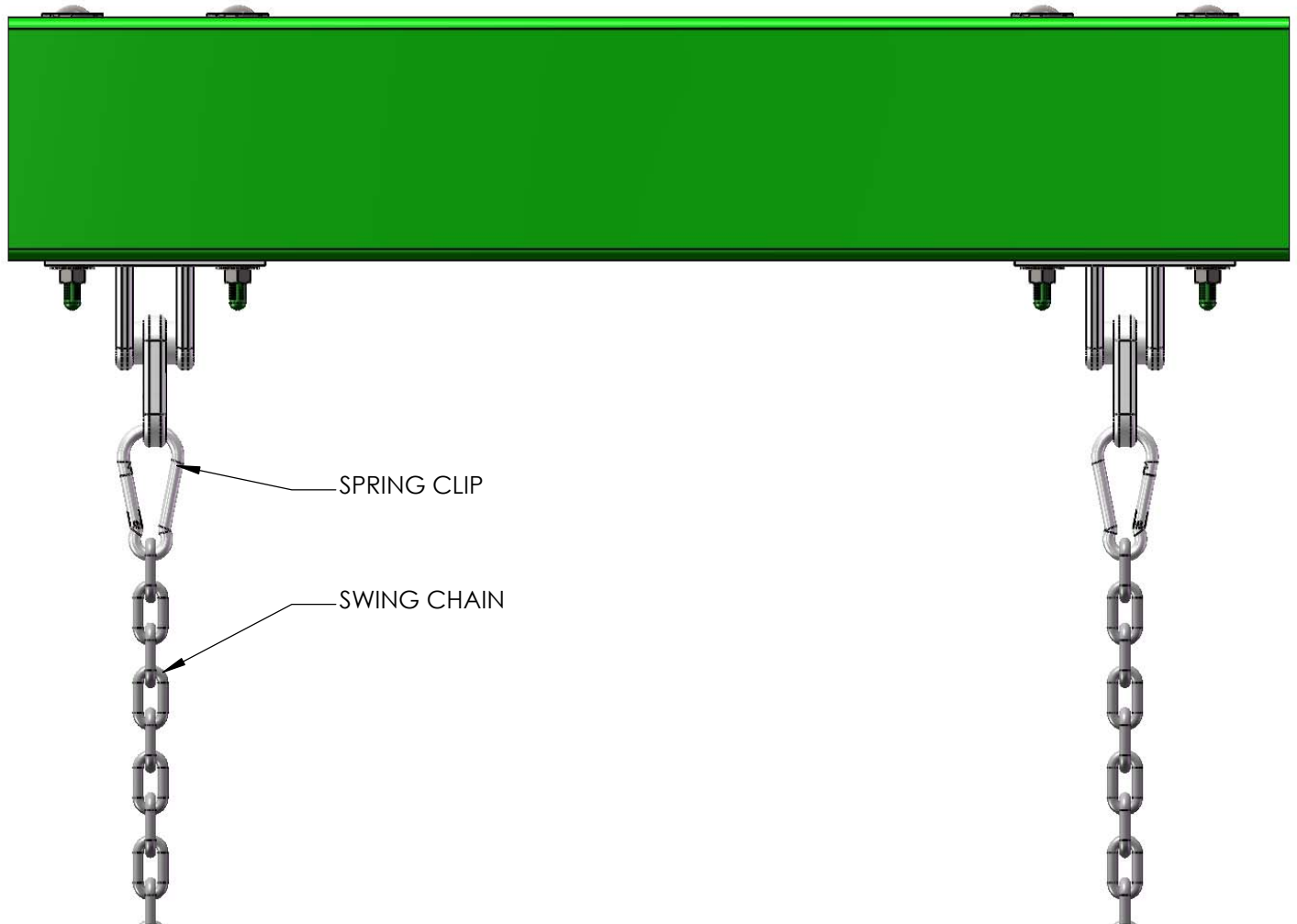

STEP 42: SAFETY BOARD

1: MEASURE 24" FROM THE BOTTOM OF THE CORNER POSTS ON THE LEFT SIDE OF THE FORT. MARK THESE POSITIONS ON THE OUTSIDE OF THE CORNER POSTS. ATTACH THE 2 X 4 X 47-1/2" SAFETY BOARD WITH OFFSET HOLES ON THE CORNER POSTS WITH 5/16 X 3-1/2" LAG SCREWS AND 5/16 WASHERS.

NOTE: THE OFFSET HOLES CAN BE PLACED UP OR DOWN IN THIS STEP.

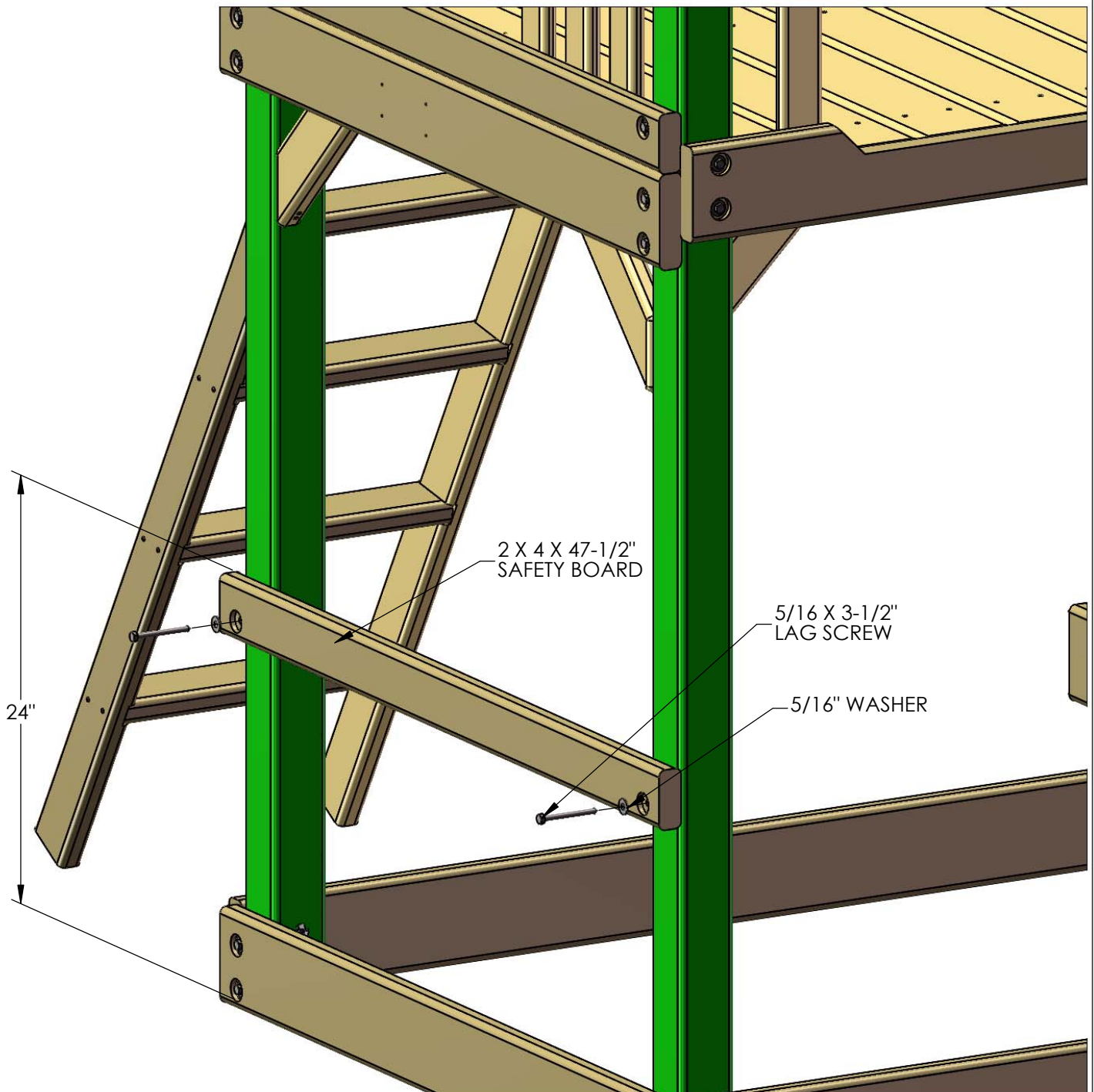

STEP 43: PICNIC TABLE

1: LOCATE TWO 2 X 4 X 14-3/4" PT TOP SUPPORTS, TWO 2 X 4 X 27-1/2" PT SEAT SUPPORTS, TWO 2 X 4 X 32-1/2" PT LEGS AND TWO 5/4 X 3 X 13-1/4" PICNIC TABLE SLATS.

2: FOR THE LEFT SIDE ASSEMBLY, PLACE A 2 X 4 X 14-3/4" PT TOP SUPPORT AND A 2 X 4 X 27-1/2" PT SEAT SUPPORT PARALLEL TO ONE ANOTHER. PLACE A 2 X 4 X 32-1/2" PT LEG ON TOP AT THE 7-1/2" DIMENSION. THE TOP OF THE PT LEG SHOULD BE FLUSH TO THE TOP OF THE PT TOP SUPPORT. ATTACH THE PT LEG TO THE SUPPORTS WITH #8 X 2-1/2" WOOD SCREWS.

3: FOR THE RIGHT SIDE ASSEMBLY, PLACE A 2 X 4 X 14-3/4" PT TOP SUPPORT AND A 2 X 4 X 27-1/2" PT SEAT SUPPORT PARALLEL TO ONE ANOTHER. PLACE A 2 X 4 X 32-1/2" PT LEG ON TOP AT THE 7-1/2" DIMENSION. THE TOP OF THE PT LEG SHOULD BE FLUSH TO THE TOP OF THE PT TOP SUPPORT. ATTACH THE PT LEG TO THE SUPPORTS WITH #8 X 2-1/2" WOOD SCREWS.

4: PLACE THE PICNIC TABLE SLAT NEXT TO THE PICNIC TABLE LEG FOR EACH ASSEMBLY BELOW. LEAVE A 3/16" GAP BETWEEN THE TOP OF THE SLAT AND THE LEG. USE THE 6-15/16" DIMENSION TO LOCATE THE BOTTOM END OF THE SLAT. FASTEN THE PICNIC TABLE SLAT TO THE SUPPORTS WITH TWO #8 X 2" WOOD SCREWS.

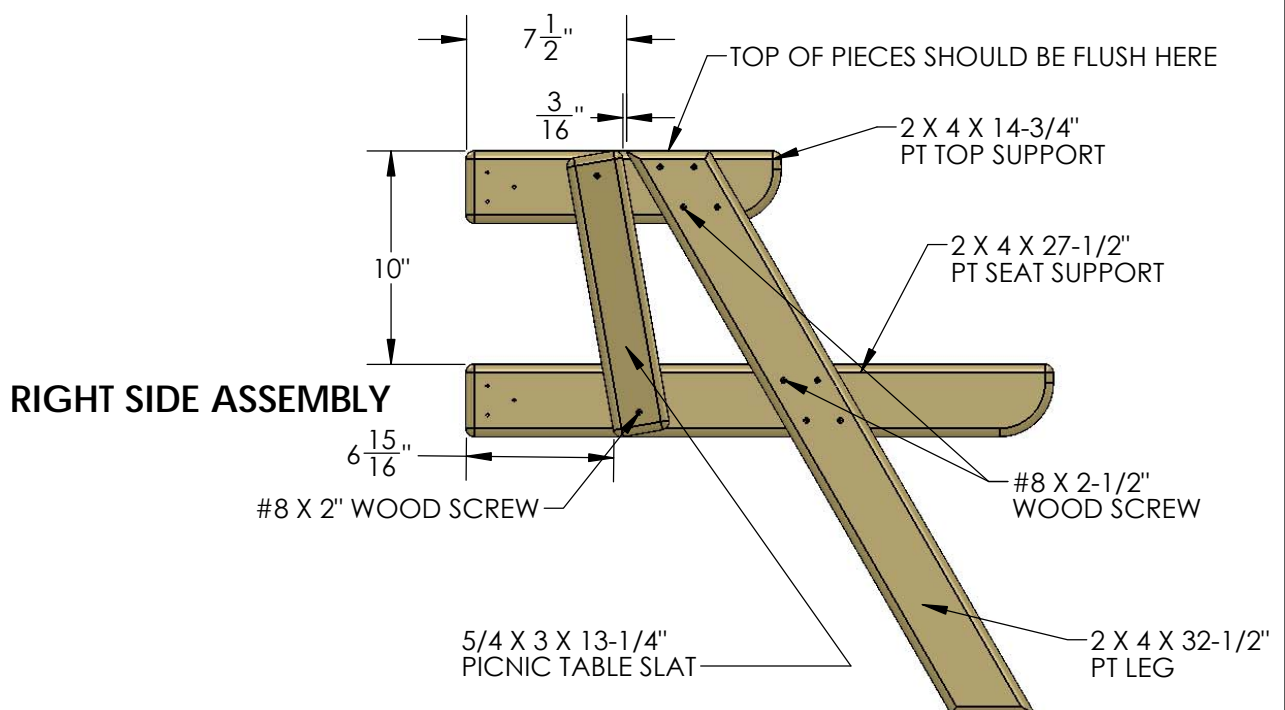
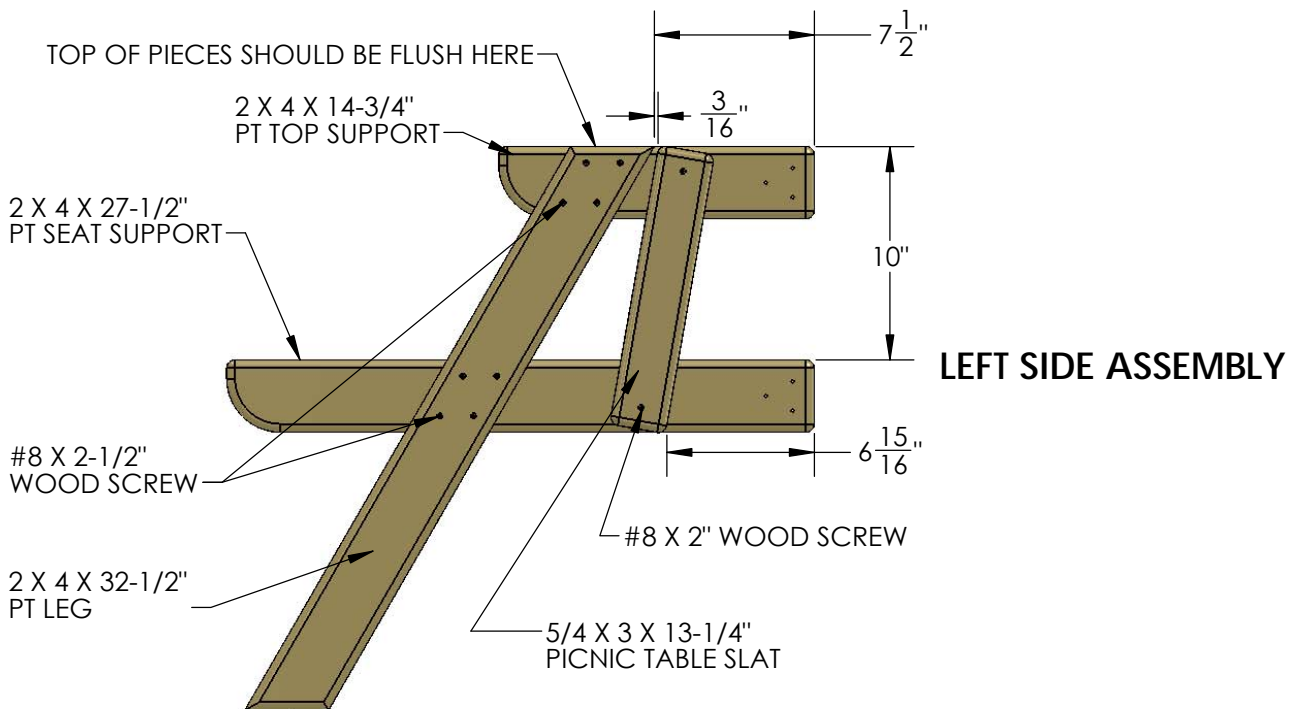

STEP 44: PICNIC TABLE

- 1: MEASURE 26-3/8" FROM THE BOTTOM OF THE CORNER POSTS ON THE RIGHT SIDE OF THE PLAYSET. MAKE MARKS ON THE INSIDE OF THE CORNER POSTS WITH A PEN OR PENCIL AT 26-3/8"
- 2: PLACE THE TOP OF THE RIGHT SIDE ASSEMBLY FLUSH TO THE MARK ON THE RIGHT FRONT CORNER POST. ATTACH THE RIGHT SIDE ASSEMBLY TO THE INSIDE OF THE CORNER POST WITH #8 X 3" WOOD SCREWS.
- 3: PLACE THE TOP OF THE LEFT SIDE ASSEMBLY FLUSH TO THE MARK ON THE RIGHT REAR CORNER POST. ATTACH THE LEFT SIDE ASSEMBLY TO THE INSIDE OF THE CORNER POST WITH #8 X 3" WOOD SCREWS.

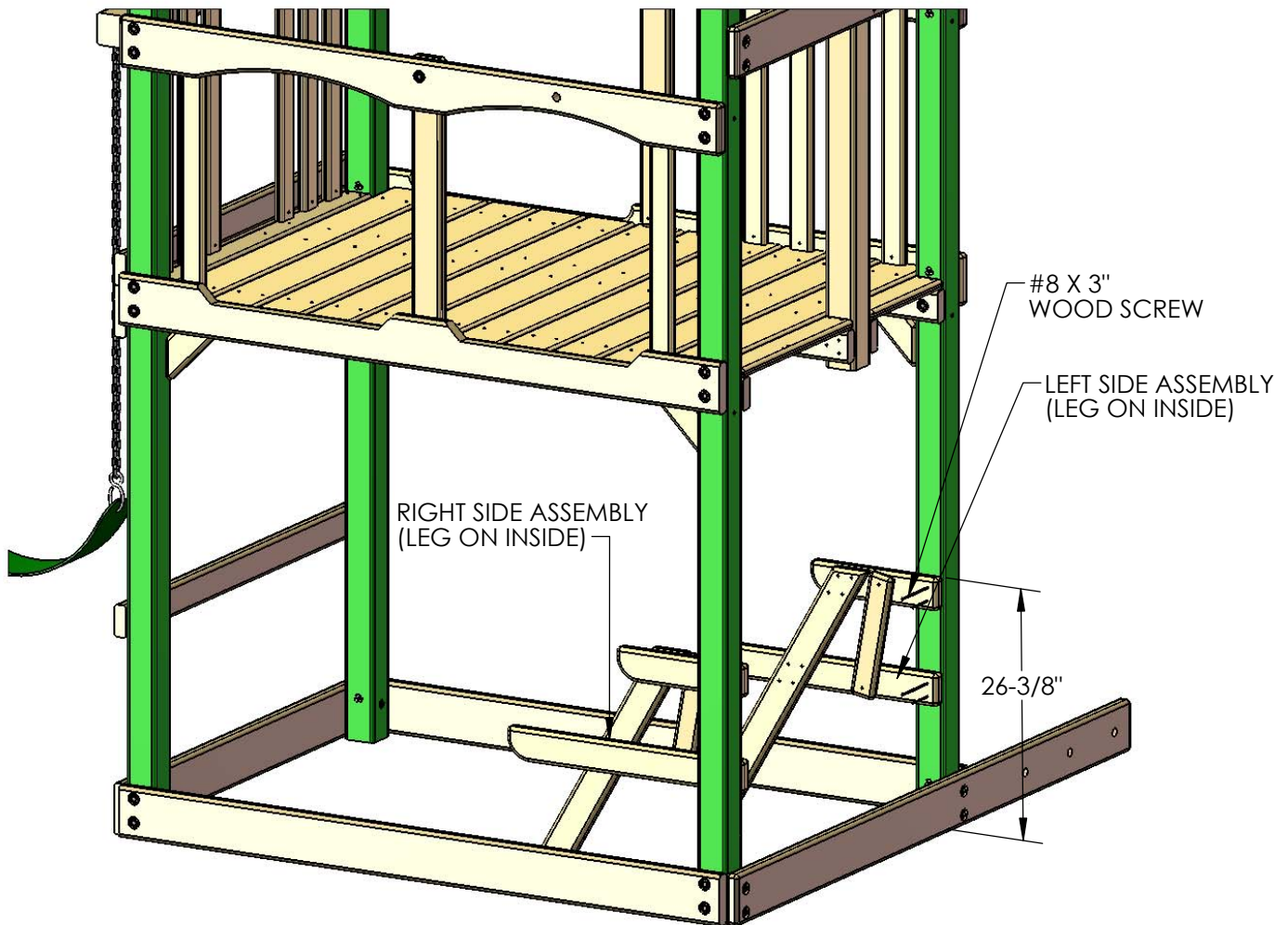

NOTE: ROCK WALL AND LADDER REMOVED FOR CLARITY.

STEP 45: PICNIC TABLE

- 1: LOCATE FOUR 5/4 X 6 X 43" PT TOP AND SEAT BOARDS.
- 2: CENTER THE HOLES IN THE BOARDS OVER THE TOP OR SEAT SUPPORTS.
- 3: FASTEN THE PT TOP AND SEAT BOARDS TO THE TOP OR SEAT SUPPORTS WITH #8 X 2-1/2" WOOD SCREWS.

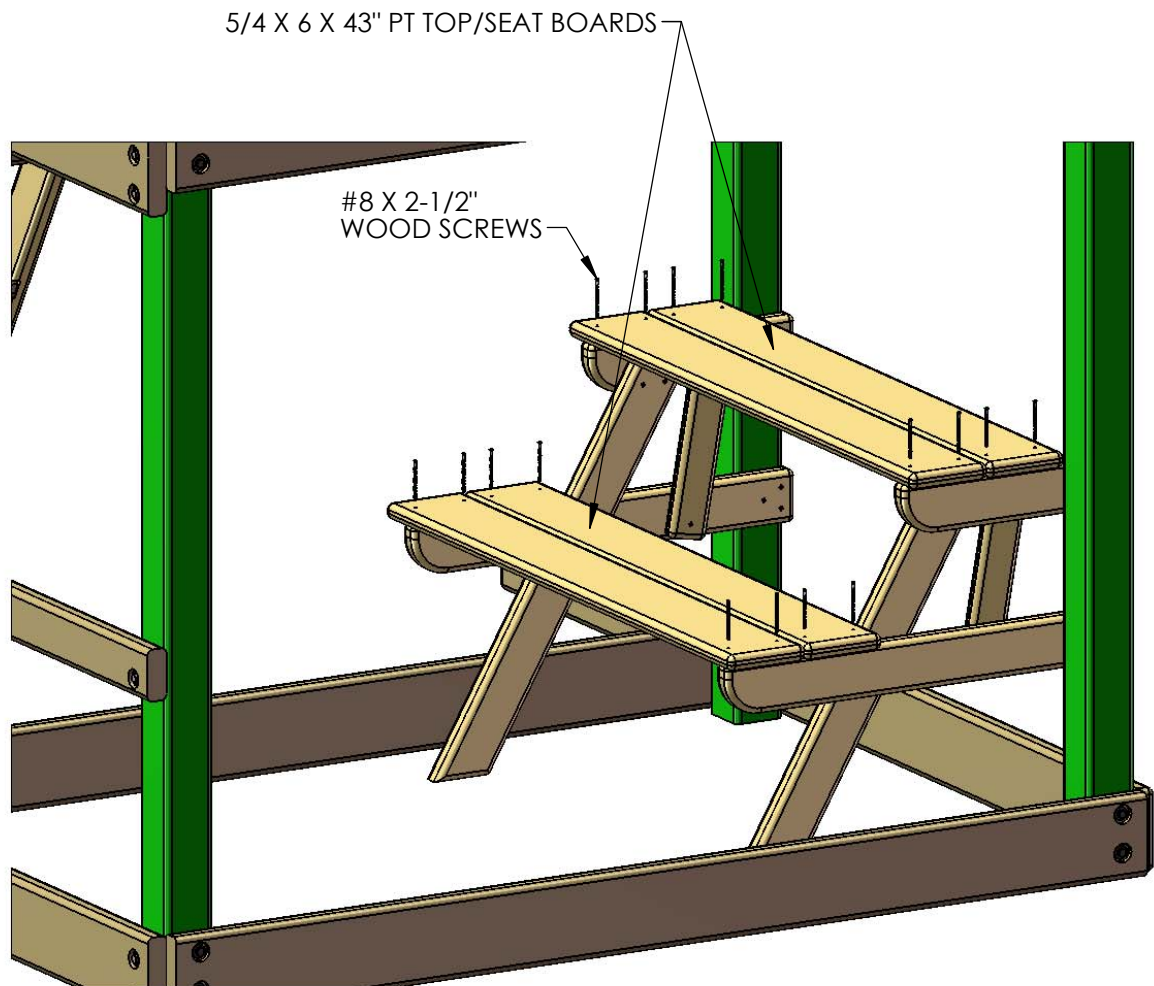

STEP 46: ROPE LADDER

1: FIND THREE ROPE LADDER ROPES. MAKE A KNOT IN THE END OF EACH ROPE AND THREAD THE FREE END THROUGH THE BACK SIDE OF THE ROPE LADDER SUPPORT. PULL EACH ROPE TAUGHT.

2: MEASURE DOWN FROM THE BOTTOM OF THE ROPE LADDER SUPPORT 14" AND TIE A KNOT. THE BOTTOM OF THE KNOT SHOULD BE 14 INCHES BELOW THE ROPE LADDER SUPPORT. SLIDE EACH ROPE THROUGH THE HOLES IN ONE ROPE LADDER RUNG. SLIDE THE RUNG UP AGAINST THE BOTTOM OF THE KNOTS.

3: TIE THREE KNOTS BELOW THE ROPE LADDER RUNG.

4: MEASURE DOWN FROM THE BOTTOM OF THE ROPE LADDER RUNG 10-5/8" AND MAKE A MARK ON THE ROPE WITH A PIECE OF TAPE OR A MARKER. THREAD ANOTHER ROPE LADDER RUNG ONTO THE HOLES.

5: WITH THE TOP OF THE RUNG EVEN WITH THE 10-5/8" MARK TIE THREE KNOTS BELOW THE SECOND ROPE LADDER RUNG.

6: REPEAT SUBSTEPS 4-5 FOR THE REMAINING ROPE LADDER RUNGS.

7: THREAD THE BOTTOM END OF EACH ROPE THROUGH THE HOLES IN THE ROPE LADDER RUNNER AND TIE THEM OFF. GRAB EACH ROPE AND ATTEMPT TO WRAP IT AROUND YOUR HAND. IF THE ROPE WRAPS AROUND YOUR HAND IT IS TOO LOOSE. IF THE ROPE IS TOO LOOSE UNTIE THE KNOT BEHIND THE ROPE LADDER RUNNER AND RETIE IT UNTIL YOU CAN NO LONGER WRAP THE ROPE AROUND YOUR HAND.

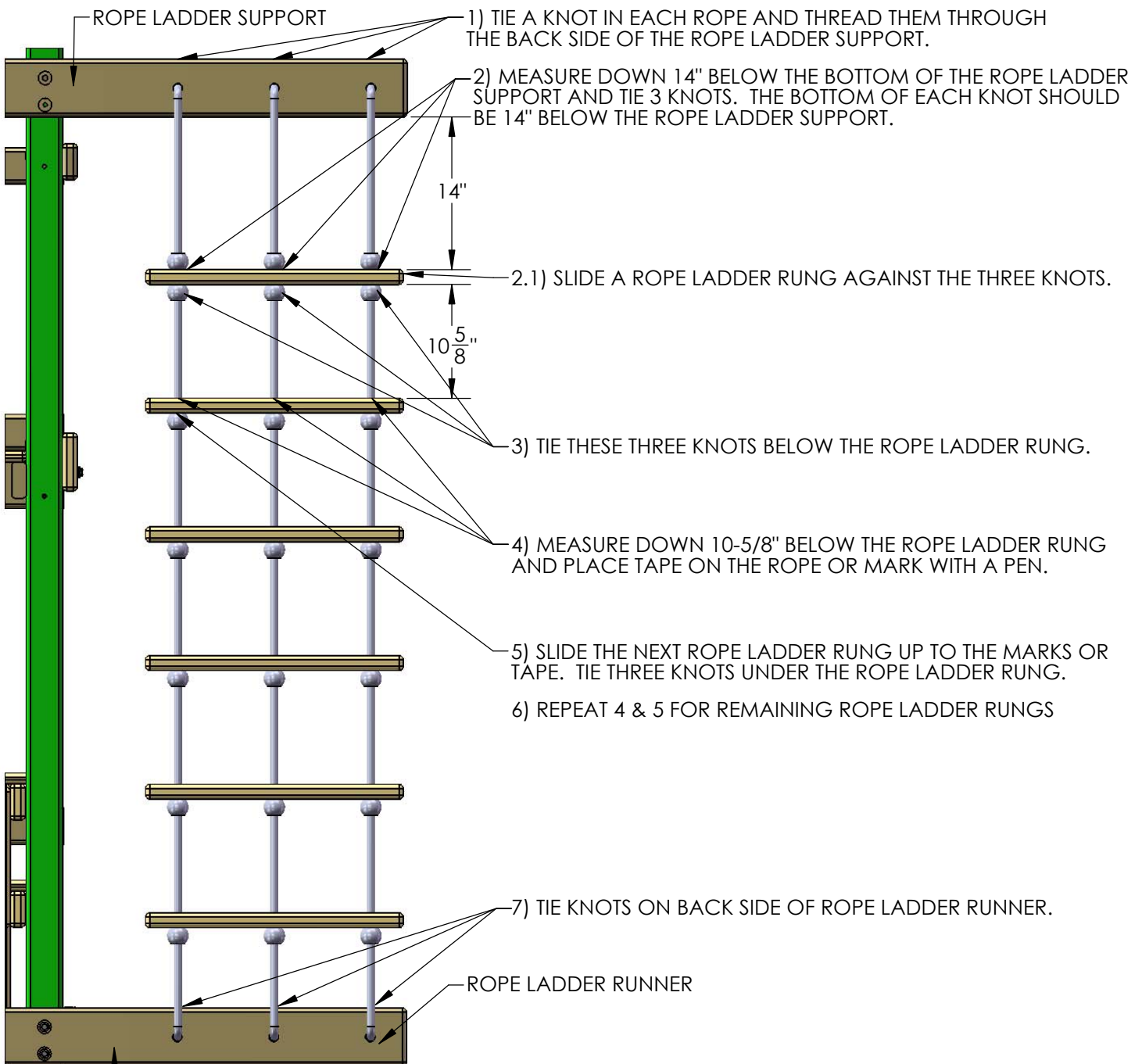

THIS IS THE VIEW AS IF YOU WERE STANDING AT THE RIGHT SIDE OF THE PLAY SET.

STEP 47: EXTREME TUBE SLIDE

1: ASSEMBLE THE EXTREME TUBE SLIDE (SEE INSTRUCTIONS ENCLOSED IN EXTREME TUBE SLIDE BOX.)

2: USE STEP 47A TO ATTACH THE SLIDE TO THE PLAY SET.

PLACE A PLASTIC "T-SHAPED" PLUG IN THE HOLE IN THE CORNER POST HERE BEFORE MOUNTING THE SLIDE TO THE PLAY SET IN THE NEXT STEP.

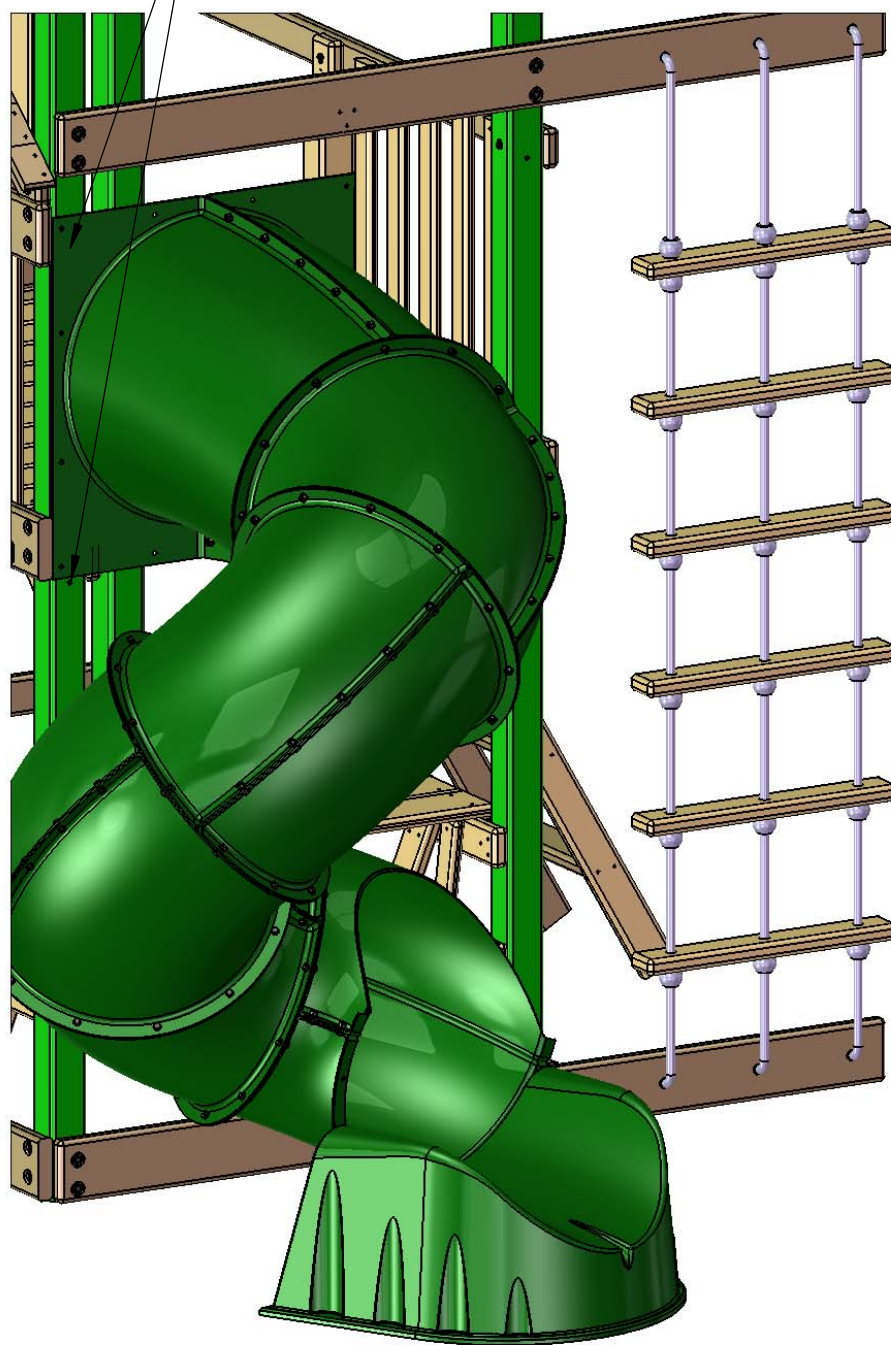

STEP 47A: ATTACHING THE SLIDE TO THE FORT

1: ATTACH SLIDE ENTRY ASSEMBLY TO THE CORNER POST AND CENTER POST OF THE FORT WITH 5/16 X 3-1/2" LAG SCREWS WITH 5/16" FENDER WASHERS.

2: DO NOT ATTACH THE BOTTOM RIGHT HOLE OF THE SLIDE ENTRY PLATE AT THIS TIME.

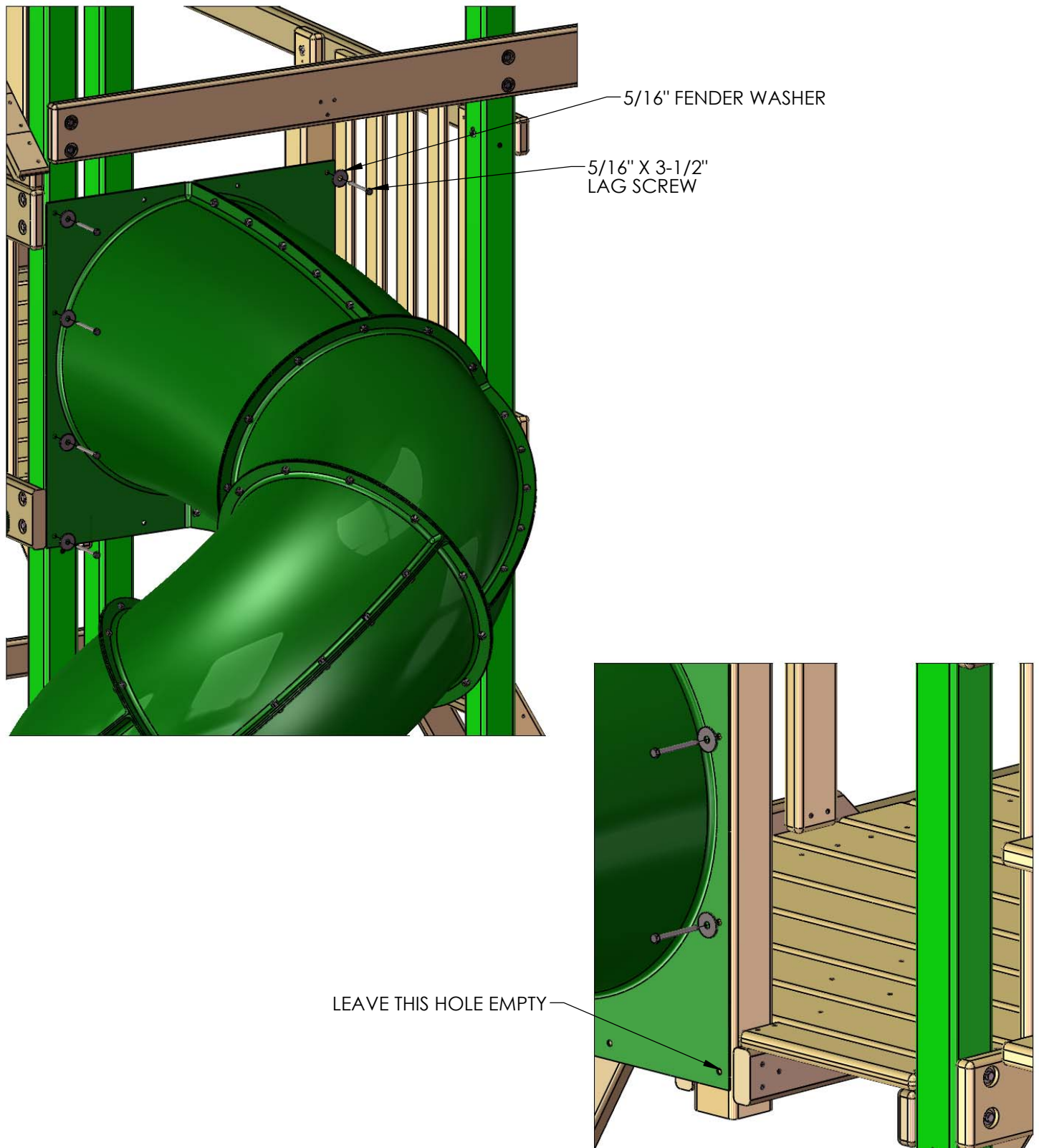

STEP 47B: SLIDE PANEL

- 1: FIND THE 2 X 4 X 21-1/2" END PANEL BOARD, AND THE 2 X 6 X 21-1/2" END PANEL BOARD.
- 2: PLACE THE 2 X 6 X 21-1/2" BOTTOM PANEL BOARD AGAINST THE CORNER POST WITH OFFSET HOLES DOWN, AND MOUNT THE BOTTOM RIGHT HOLE WITH A 5/16 X 4-1/2" HEX BOLT AND 5/16" WASHER INTO THE HOLE OF THE CORNER POST, AND INTO THE T-NUT.
- 3: FASTEN THE REMAINING HOLES OF THE 2 X 6 X 21-1/2" END PANEL BOARD TO THE CORNER POST AND CENTER POST WITH 5/16 X 3-1/2" LAG SCREWS AND 5/16" WASHERS.
- 4: PLACE THE 2 X 4 X 21-1/2" END PANEL BOARD ABOVE THE 2 X 6 X 21-1/2" END PANEL BOARD, AND FASTEN TO THE CENTER POST AND CORNER POST WITH 5/16 X 3-1/2" LAG SCREWS AND 5/16" WASHERS.
- 5: FROM THE INSIDE OF THE FORT, FASTEN THE 5/4 X 3 X 33" PANEL SLATS WITH 2" WOOD SCREWS.
- 6: TIGHTEN ALL HARDWARE ON THE SLIDE.

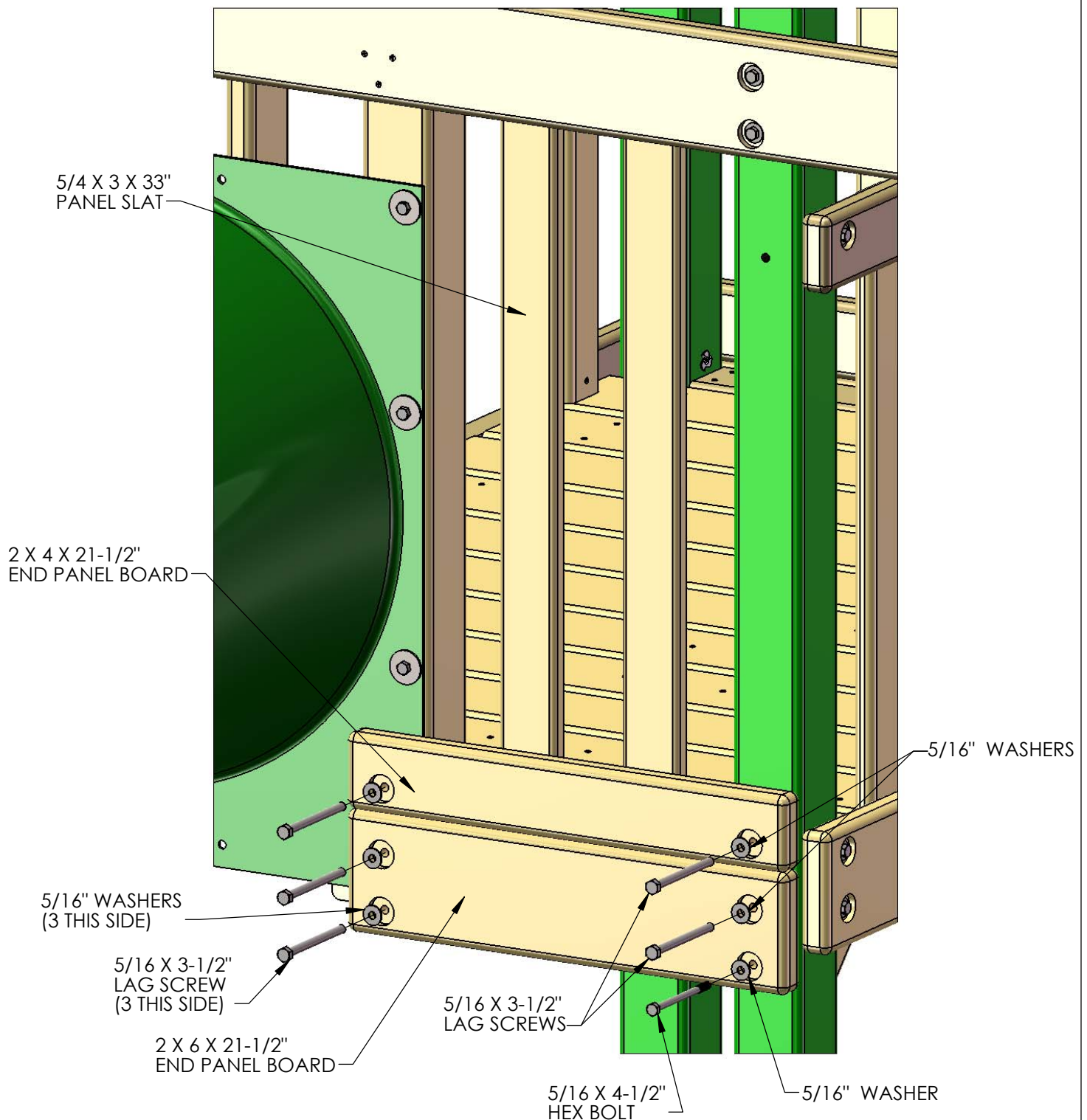

STEP 47C: ATTACHING SLIDE HEADER BOARD

1: PLACE THE 2 X 4 X 29-1/4" SLIDE HEADER BOARD BETWEEN THE SLIDE AND THE ROPE LADDER SUPPORT. ATTACH SLIDE HEADER BOARD TO POSTS WITH 5/16" X 3-1/2" LAG SCREWS AND 5/16" WASHERS.

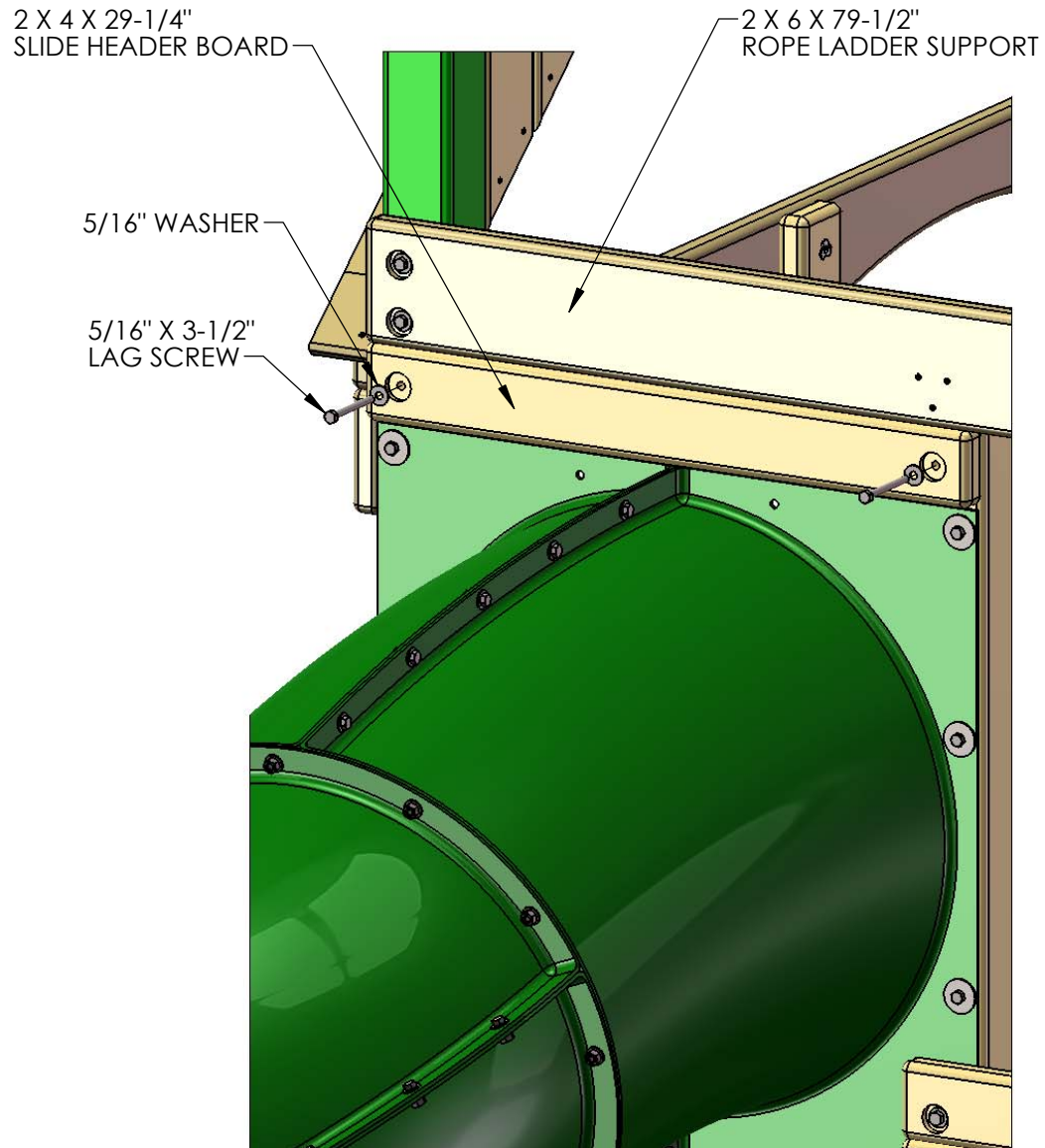

STEP 48: ANGLE SUPPORTS ON TUBE SLIDE SIDE

- 1: TWO 2 X 4 X 18" ANGLE SUPPORTS ARE MOUNTED UNDER THE DECK ON THE RIGHT SIDE (TUBE SLIDE SIDE).
- 2: FOR THE ANGLE SUPPORT AT THE RIGHT REAR USE TWO 2-1/2" WOOD SCREWS THROUGH THE TOP OF THE BRACE INTO THE 2 X 6 X 21-1/2" END PANEL BOARD. USE ONE 2" AND ONE 3" WOOD SCREW TO FASTEN THE ANGLE SUPPORT TO THE RIGHT REAR CORNER POST.

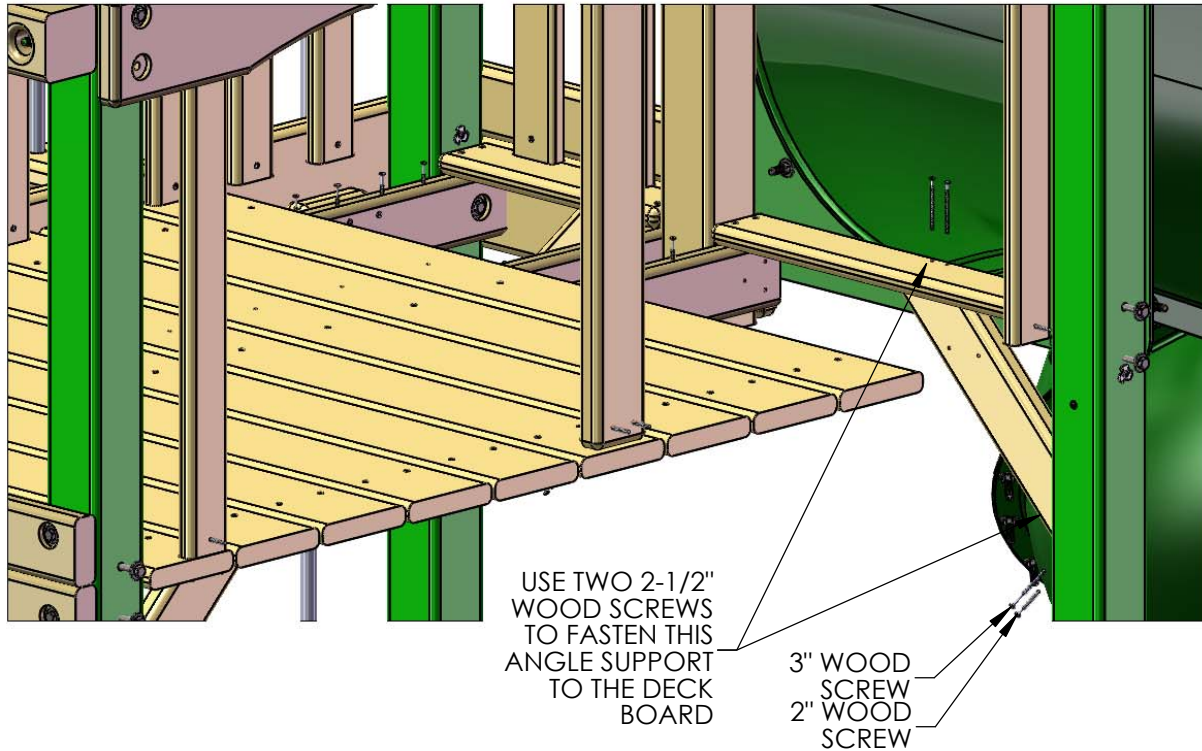

- 3: FOR THE 2 X 4 X 18" ANGLE SUPPORTS AT THE RIGHT FRONT USE TWO 2-1/2" WOOD SCREWS THROUGH THE DECK AND INTO THE ANGLE SUPPORT. USE ONE 2" AND ONE 3" WOOD SCREW TO FASTEN THE RIGHT FRONT ANGLE SUPPORTS TO THE RIGHT FRONT CORNER POST.

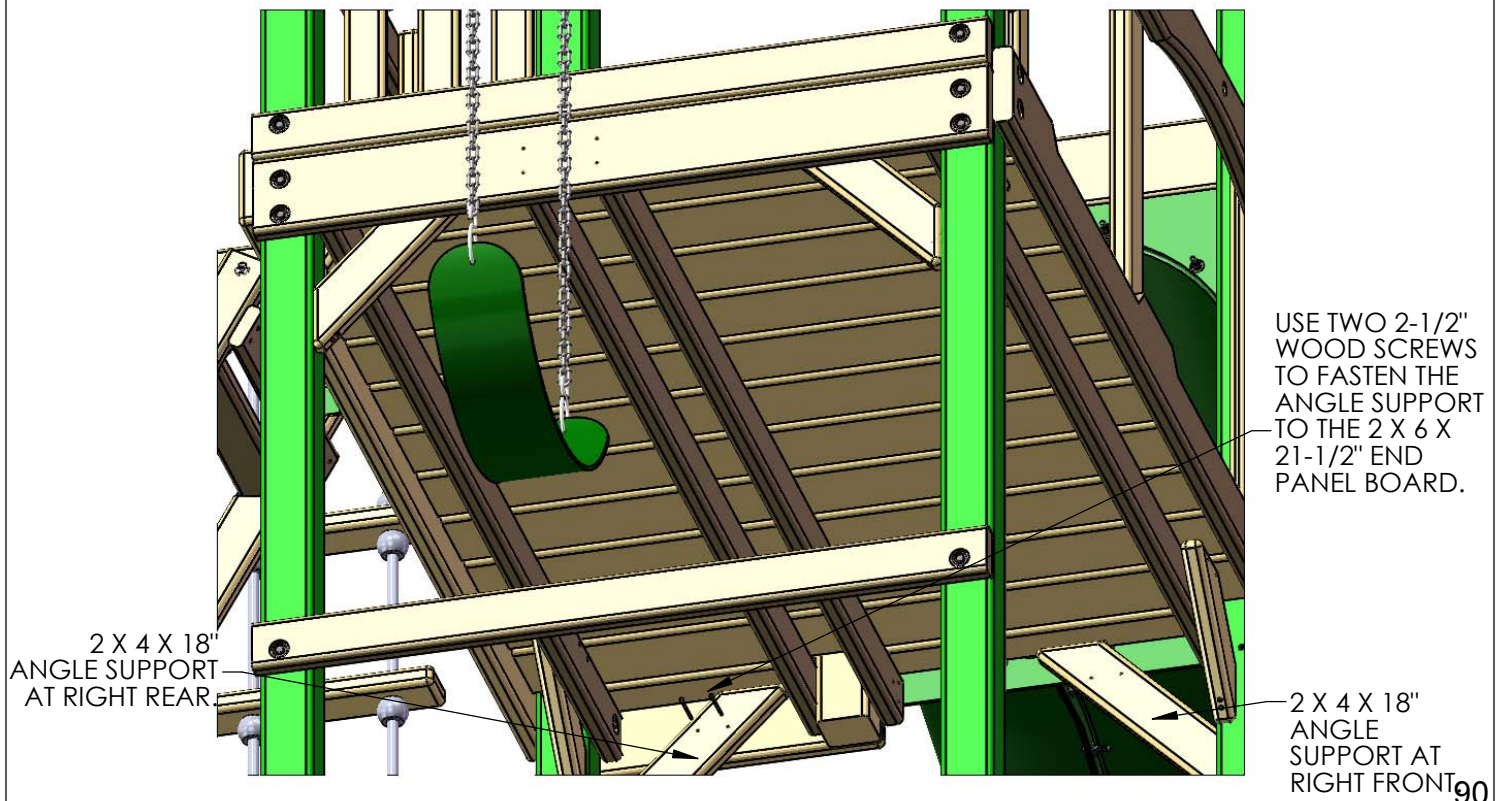

STEP 49: WAVE SLIDE

- 1: PLACE THE SLIDE IN THE OPENING AT THE FRONT OF THE FORT. LAY THE SLIDE ON THE DECK WITH THE LIP EXTENDING ONTO THE DECK.
- 2: PREDRILL 1/8" HOLES INTO THE DECK BOARDS AT THE SCREW LOCATIONS.
- 3: ATTACH THE SLIDE TO THE DECK WITH 1-1/4" PAN HEAD SCREWS. ****DO NOT OVERTIGHTEN****

#14 X 1-1/4" PAN HEAD SCREW
****DO NOT OVERTIGHTEN****



STEP 50: INSTALLING THE ROCK WALL ROPE

1: TIE A KNOT AT ONE END OF THE 10' ROPE AND THREAD IT THROUGH THE BACK SIDE OF THE HOLE IN THE FRONT TOP PANEL BOARD.

2: THE UNTIED END WILL GO THROUGH THE HOLE OF THE BOTTOM ROCK WALL BOARD. TIE A SECURE KNOT AT THE END MAKING SURE THAT THE ROPE IS TIGHT AND WILL NOT WRAP AROUND YOUR HAND. HINT: TO REDUCE THE AMOUNT OF SLACK IN THE ROPE, LIFT THE ROCK WALL ASSEMBLY SLIGHTLY WHEN TYING THE KNOT IN THE BOTTOM ROCK WALL BOARD. WHEN YOU LOWER THE ASSEMBLY, THE ROPE WILL TIGHTEN.

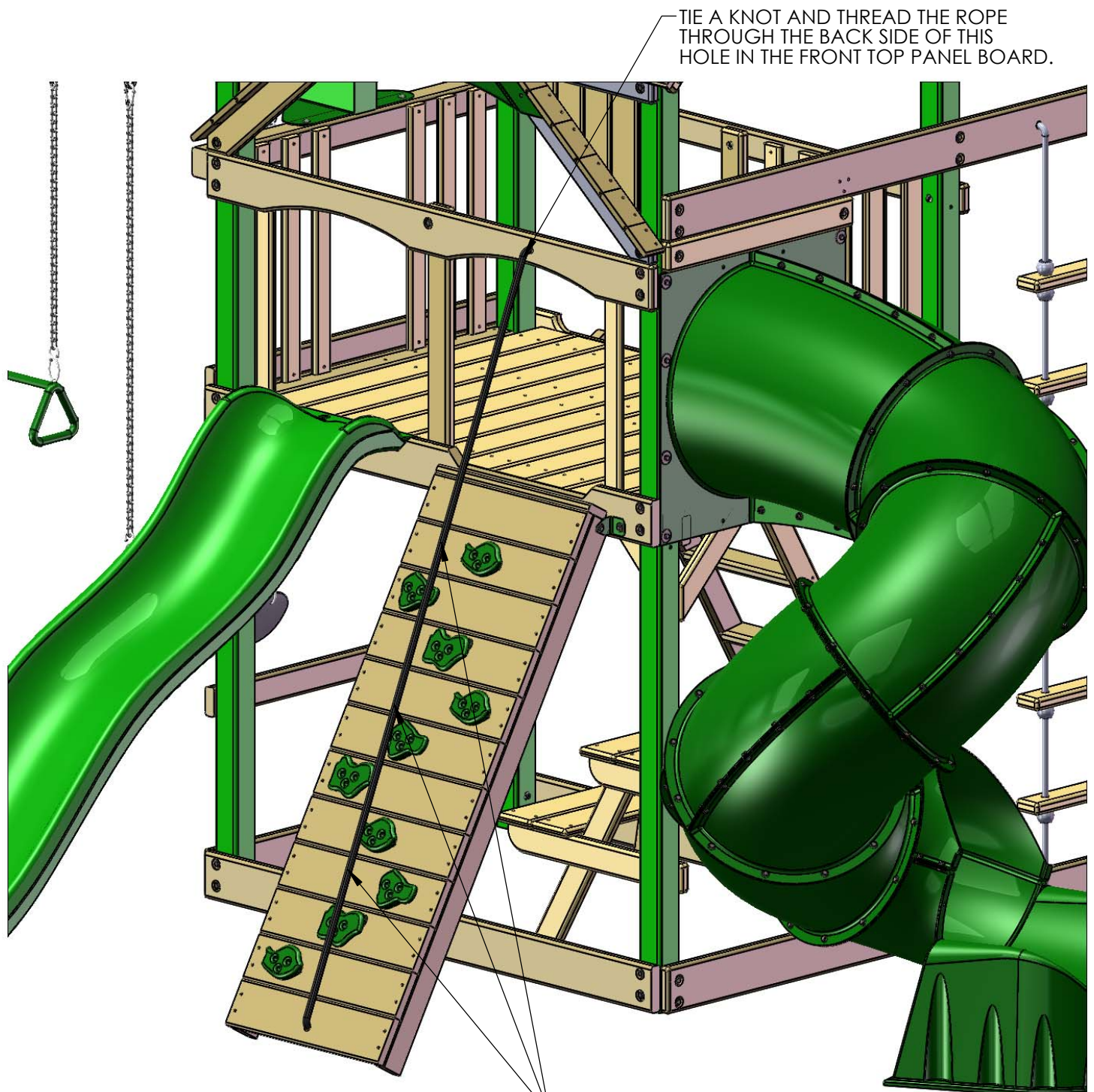

NOTE: YOU MAY TIE UP TO THREE KNOTS SPACED ABOUT 18" APART TO AID IN CLIMBING.

STEP 51: SAFETY HANDLES

- 1: LOCATE THE SAFETY HANDLE BAG.
- 2: ADJUST THE SAFETY HANDLES UP OR DOWN TO SUIT THE NEEDS OF YOUR CHILD.
- 3: ATTACH EACH SAFETY HANDLE TO THE PANEL CENTER POST OR CORNER POST WITH TWO PAN HEAD SCREWS AND TWO WASHERS PROVIDED WITH THE SAFETY HANDLES.

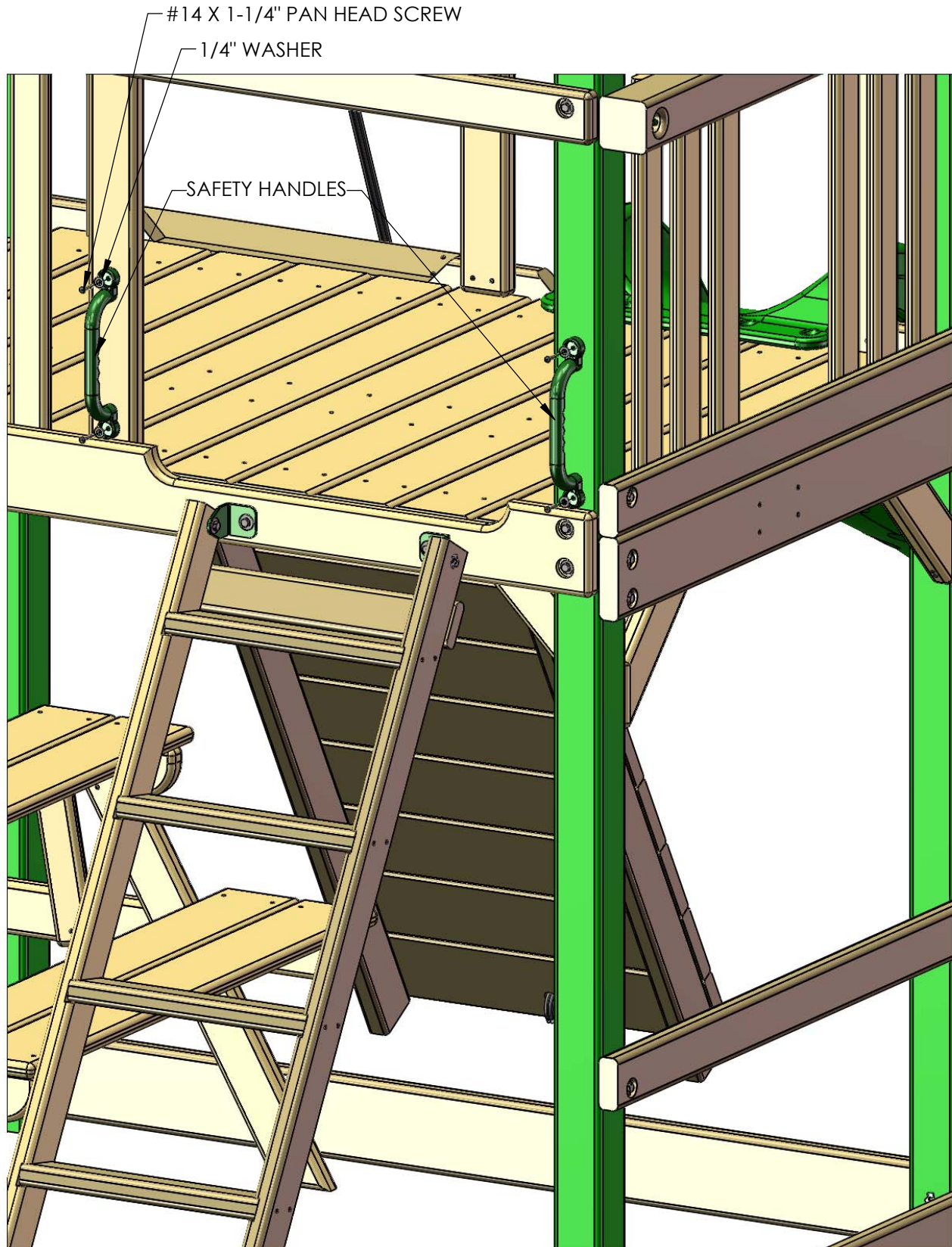

STEP 52: TELESCOPE

1: WITH THE 1-1/4" WOOD SCREWS PROVIDED IN THE TELESCOPE BAG, FASTEN ONE OF THE SQUARE TELESCOPE BRACKETS TO THE FRONT TOP PANEL BOARD ON THE SLIDE SIDE OF THE CENTER POST.

2: PLACE THE TELESCOPE STAND AND TELESCOPE INTO THE SLOT OF THE TELESCOPE BRACKET.

3: FASTEN THE REMAINING TELESCOPE BRACKET TO THE OPPOSITE SIDE THAT THE FIRST TELESCOPE BRACKET WAS INSTALLED ON WITH 1-1/4" WOOD SCREWS PROVIDED WITH THE TELESCOPE.

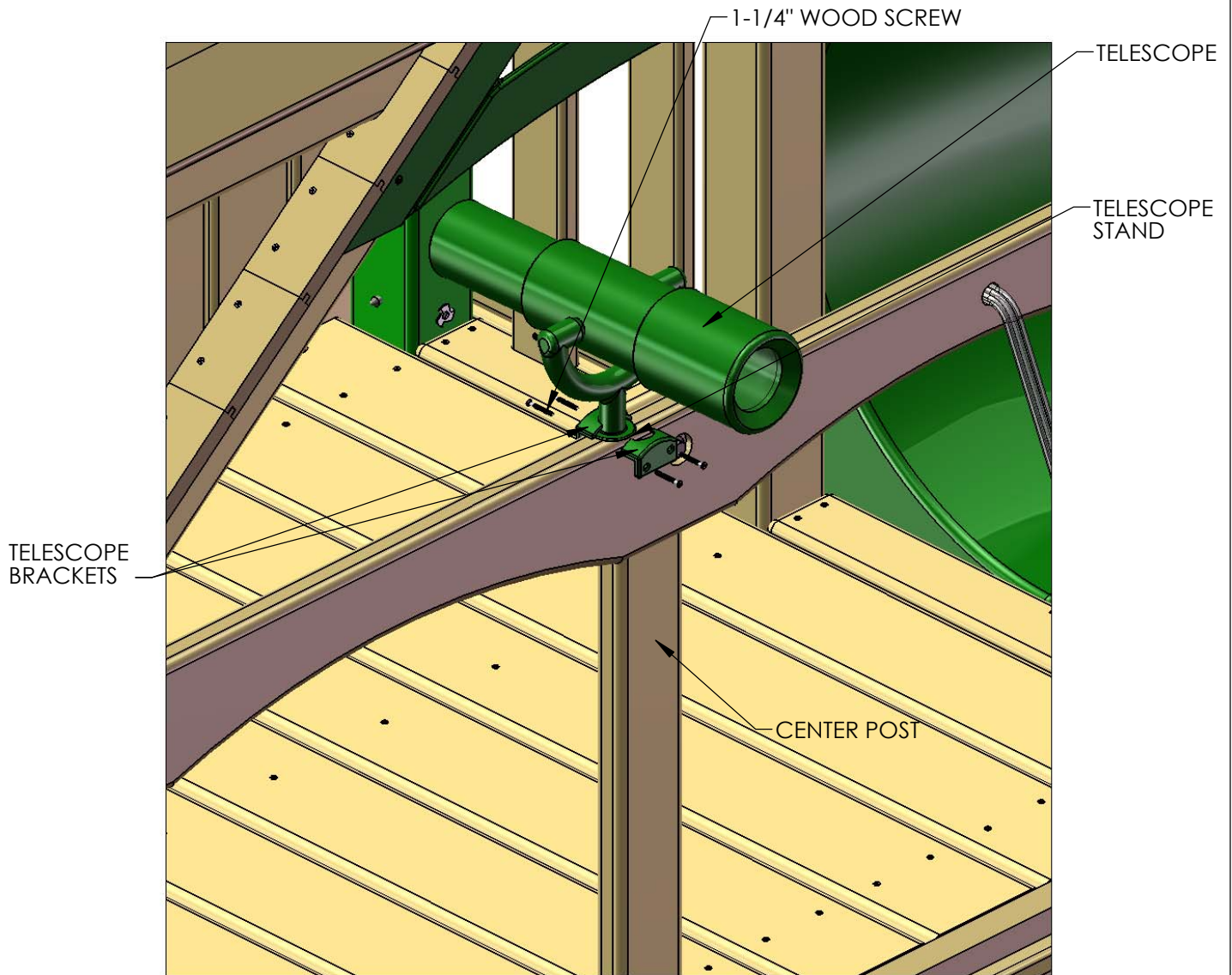

STEP 53: TIC TAC TOE ASSEMBLY

1: LOCATE THE TIC TAC TOE BOX.

2: FOLLOW THE INSTRUCTIONS IN THE BOX TO ASSEMBLE THE TIC TAC TOE OMITTING STEPS 6 AND 7.

3: LOCATE TWO 5/4 X 3 X 17-1/2" TIC TAC TOE MOUNTS.

4: USE THE SCREWS INCLUDED WITH THE TIC TAC TOE TO ATTACH THE GREEN BRACKETS TO THE TIC TAC TOE MOUNTS. EACH GREEN BRACKET SHOULD BE CENTERED OVER THE TIC TAC TOE MOUNT.

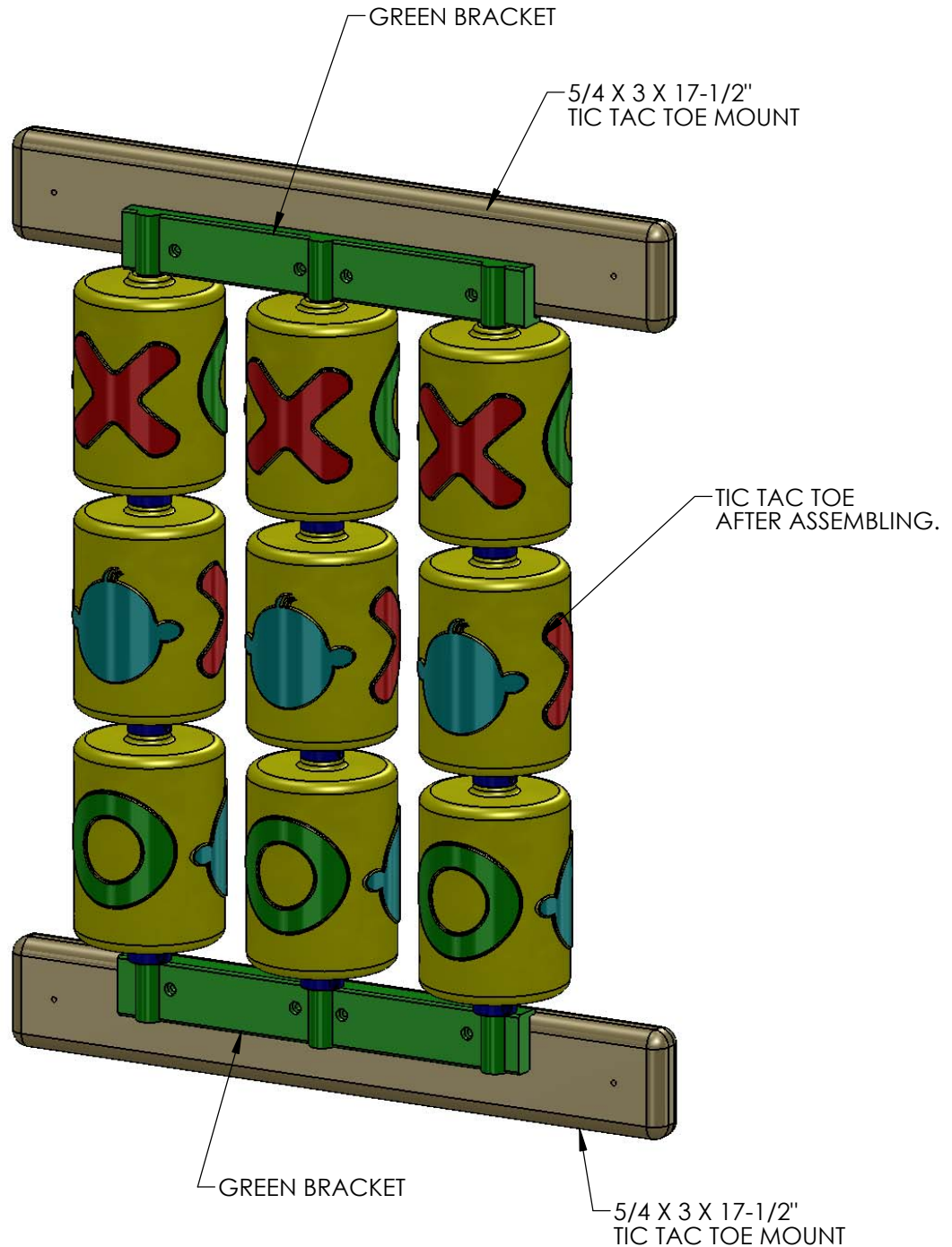

STEP 54: TIC TAC TOE INSTALLATION

1: PLACE THE TIC TAC TOE AGAINST THE PANEL SLATS AT THE LEFT SIDE OF THE PLAY SET ON THE INSIDE. THE TIC TAC TOE MOUNT SHOULD BE APPROXIMATELY 4" OFF THE DECK.

2: ATTACH THE TIC TAC TOE MOUNTS TO THE PANEL SLATS WITH #8 X 1-3/4" WOOD SCREWS.

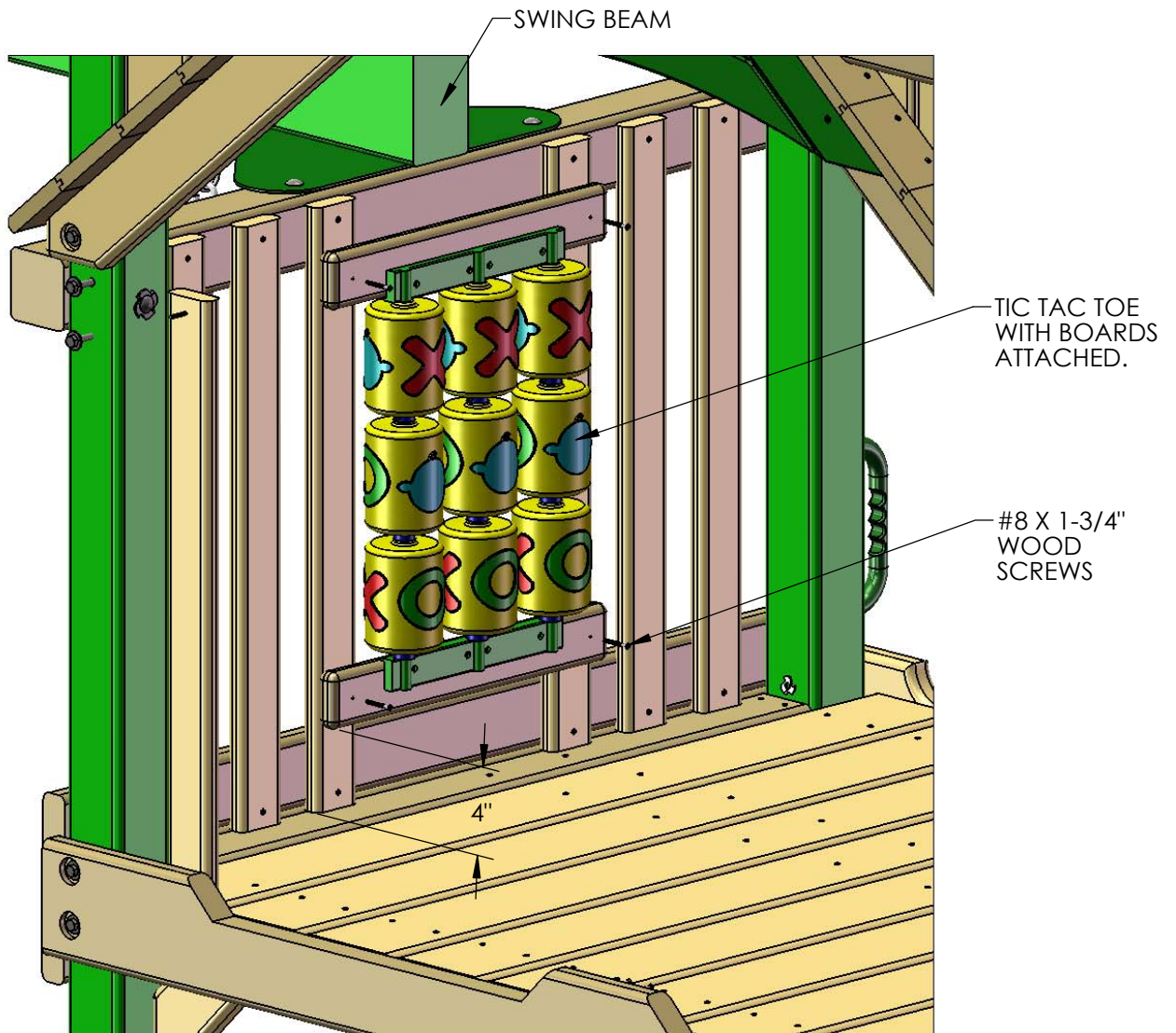

STEP 55: SANDBOX SEATS AND NAME PLATE

- 1: PLACE THE 5/4 X 6 X 22" SANDBOX SEATS ONTO THE TOP OF THE SANDBOX BOARDS AS SHOWN BELOW.
- 2: ATTACH THE SANDBOX SEATS TO THE SANDBOX BOARDS WITH #8 X 2" WOOD SCREWS.
- 3: LOCATE THE NAME PLATE FOR YOUR PLAY SET. ATTACH THE NAME PLATE TO THE FRONT OF THE SWING BEAM WITH #8 X 1" WOOD SCREWS.

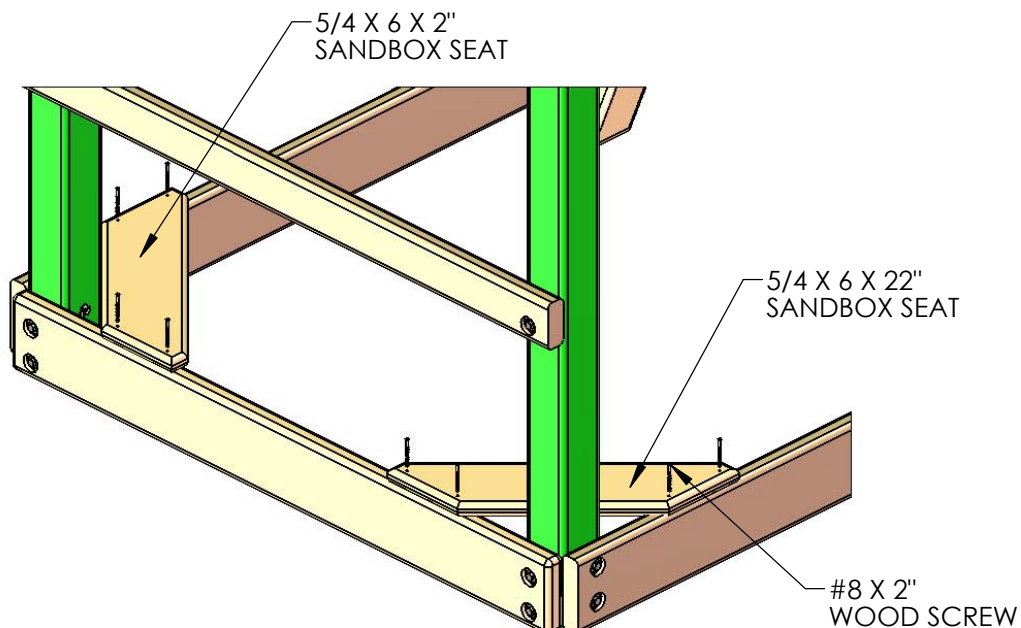
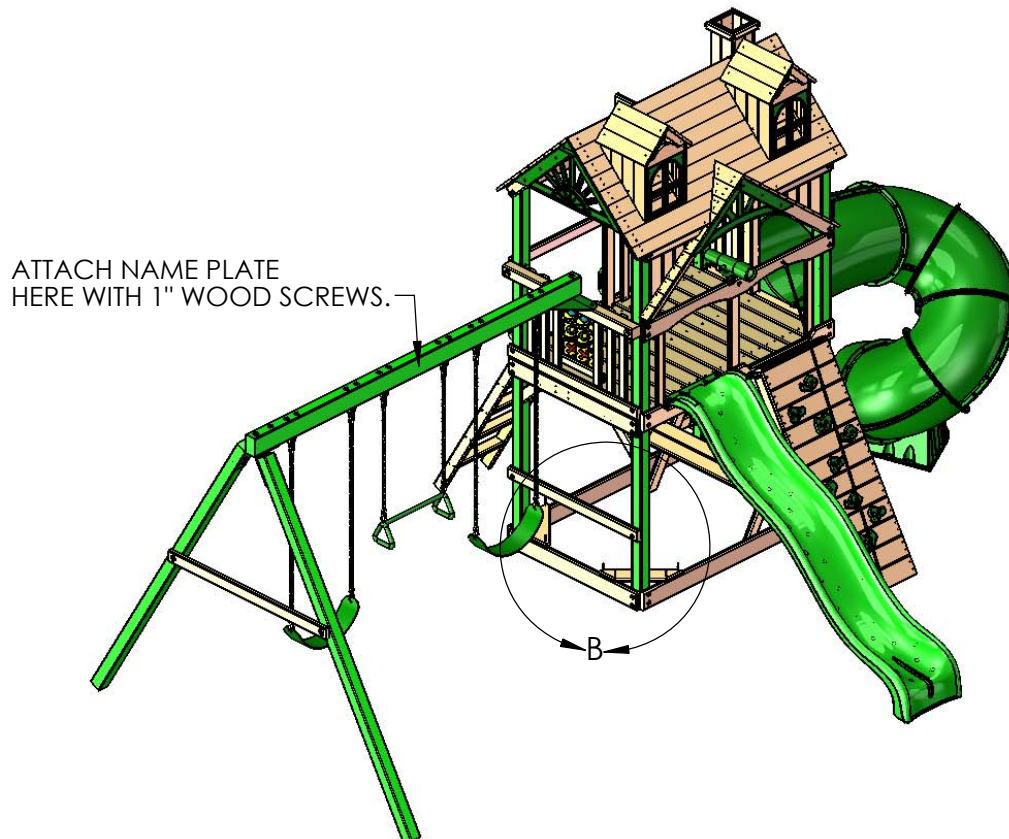

STEP 56: SOLAR WALL LIGHTS

1: WITH A PENCIL MAKE A CENTER MARK ON THE OUTSIDE FACE OF THE 1 X 4 X 19.31 WALL PANEL BOARD, MEASURE 4-7/8" HORIZONTALLY FROM THE OUTSIDE EDGE OF THE CORNER POST TOWARDS THE CENTER OF THE WALL PANEL BOARD AND 2-3/8" FROM THE BOTTOM EDGE OF THE WALL PANEL SUPPORT TOWARDS THE CENTER OF THE WALL PANEL BOARD AS SHOWN IN THE DIAGRAM BELOW.

2: PARTIALLY INSERT A #8 X 1" WOOD SCREW INTO THE WALL PANEL BOARD CENTER MARK FROM PREVIOUS SUB-STEP, MAKE SURE THE HEAD OF THE SCREW IS STICKING OUT ABOUT 3/8" FROM THE OUTSIDE FACE OF THE WALL PANEL BOARD.

3: MOUNT THE SOLAR WALL LIGHT ON TO THE WALL USING THE HEAD OF THE WOOD SCREW AS A HANGER IN TO THE SLOT LOCATED IN THE BACK OF THE SOLAR WALL LIGHT. **THE ON/OFF SWITCH IS LOCATED IN THE BOTTOM REAR END OF THE SOLAR WALL LIGHT, YOU CAN ACCESS TO THIS SWITCH BY SWINGING THE SOLAR WALL LIGHT TOWARDS THE OUTSIDE OF THE CORNER POST.**

4: REPEAT SUB-STEPS 1 TO 3 FOR THE OTHER SIDE.



1" WOOD SCREW

SOLAR WALL LIGHT

1 X 4 X 19.31
WALL PANEL BOARD

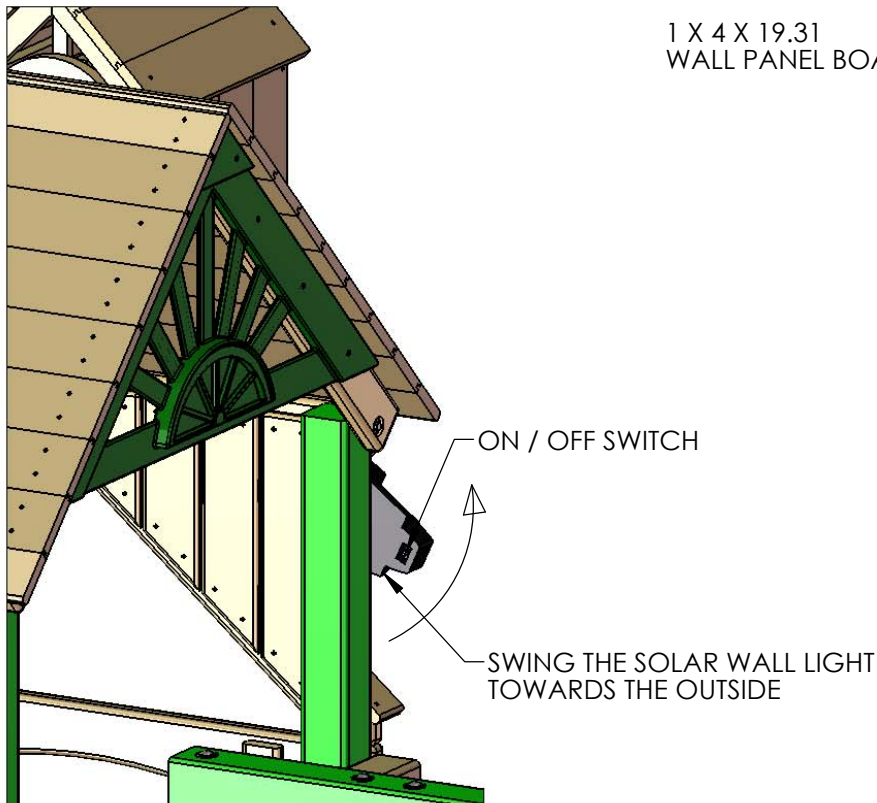

STEP 57: STEERING WHEEL

- 1: GO TO THE REAR CENTER POST ON THE DECK.
- 2: DRILL A 3/16" PILOT HOLE 1" BELOW THE CENTER OF THE T-NUT. DRILL THE HOLE 2" DEEP.
- 3: PLACE THE STEERING WHEEL INSERT INSIDE THE STEERING WHEEL.
- 4: USE THE 2-1/2" LAG SCREW AND WASHER TO FASTEN THE STEERING WHEEL TO THE REAR CENTER POST. DO NOT OVER-TIGHTEN THE LAG SCREW OR THE STEERING WHEEL WILL NOT TURN.
- 5: PLACE THE STEERING WHEEL CAP OVER THE CENTER OF THE STEERING WHEEL AND SNAP IT INTO THE STEERING WHEEL INSERT.

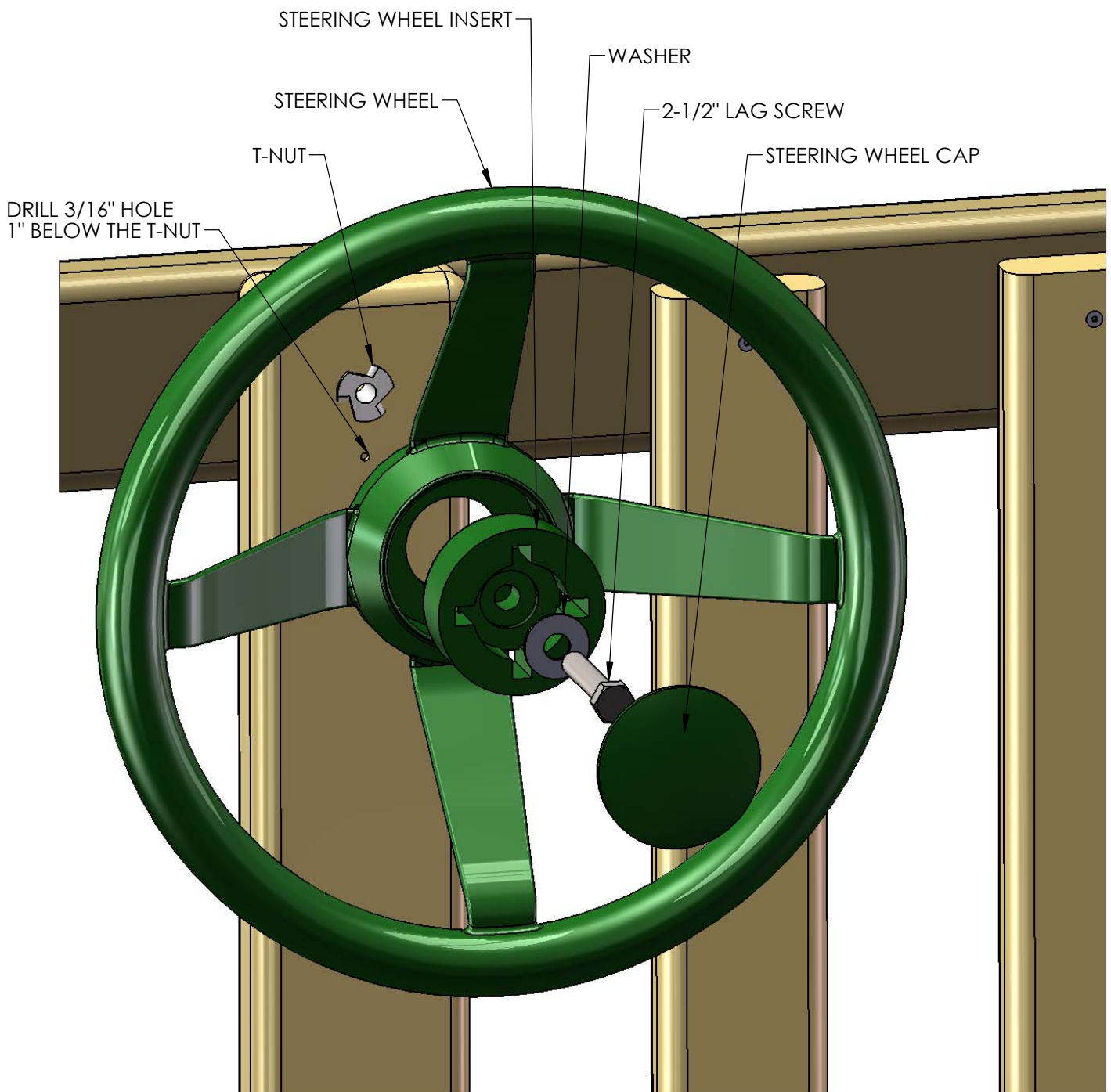

STEP 58: GROUND STAKES

1: HAMMER A GROUND STAKE INTO THE EARTH NEXT TO EACH SWING LEG AT AN ANGLE. DO NOT HOLD THE UPPER PORTION OF THE STAKE AFTER THE FIRST COUPLE OF HITS OR IT MAY VIBRATE HARSHLY AGAINST YOUR HAND. IF THE TOP PART OF THE STAKE TWISTS WHEN IT ENCOUNTERS A ROCK OR ROOT YOU MAY HAVE TO BEND THE TOP PORTION OF THE STAKE AGAINST THE SWING LEG. FINALLY INSTALL THE SCREW AND WASHER.

2: ATTACH EACH GROUND STAKE TO THE SWING LEG WITH A #14 X 2" PAN HEAD SCREW AND A 1/4" FENDER WASHER PROVIDED WITH THE GROUND STAKE.

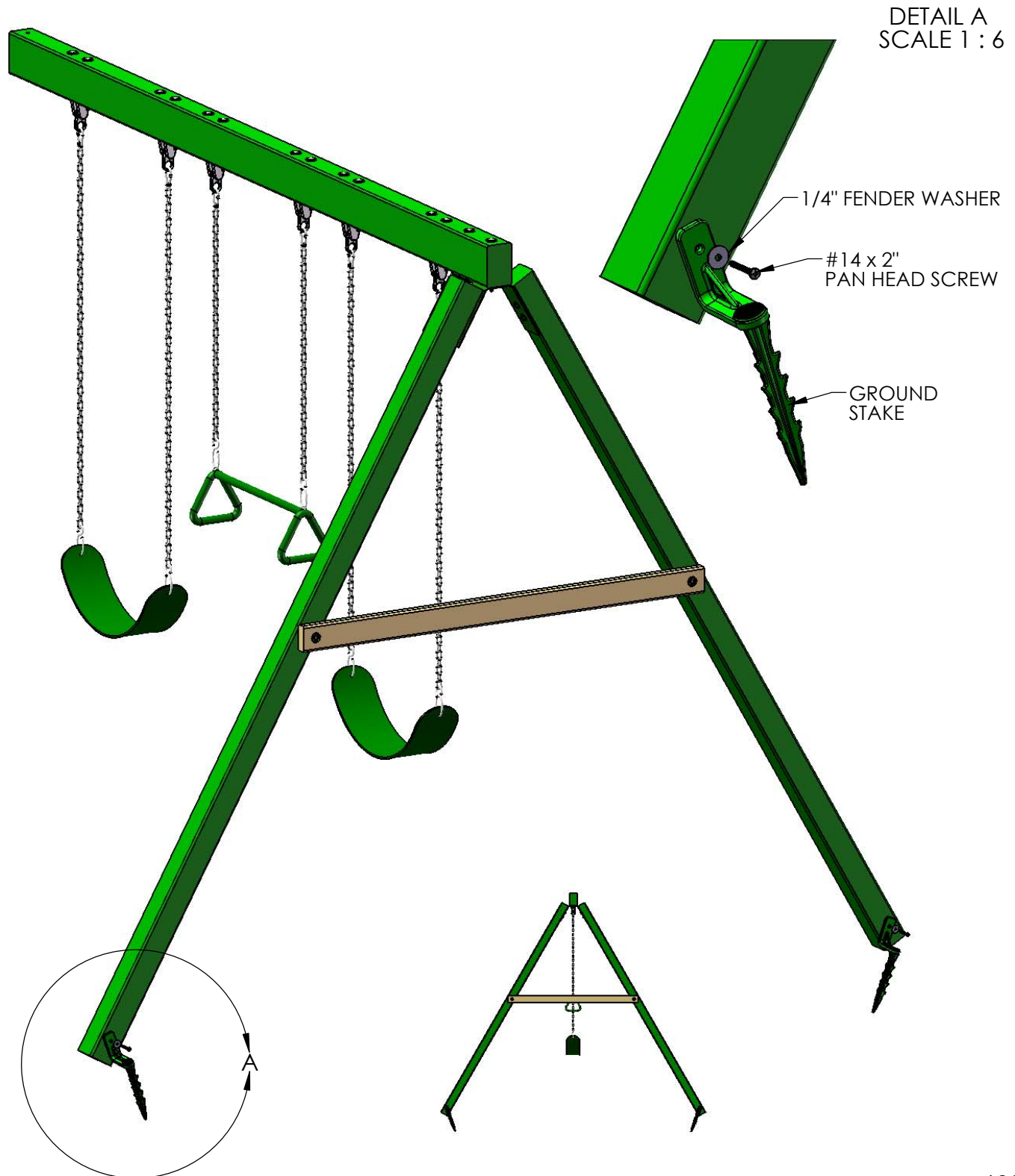

Leftover Parts List 1500CW/CWR/CT Play Sets

Our 1500 series play sets are modular and include parts to construct many different models. Some of these parts included with your play set will not be used because they are for a different model. The list below includes parts for your play set that will be leftover when construction is completed.

2 pieces 125-3-2825-PS Panel Slats (We include these parts in case the customer wishes to fill in the area where the Tic Tac Toe is located. Should the Tic Tac Toe become damaged the customer could use these boards to fill in the gap until a replacement Tic Tac Toe is ordered.)

1 piece 125-4-4038-DS Deck Spacer (This part is only used for sets in the 1500 series without a tube slide on the side of the unit.)

APPENDIX

#8 X 1-1/4"
WOOD SCREW
QTY: 22



#8 X 1-1/2"
WOOD SCREW
QTY: 34



#8 X 1-3/4"
WOOD SCREW
QTY: 8



#8 X 2"
WOOD SCREW
QTY: 6



#8 X 2-1/2"
WOOD SCREW
QTY: 4

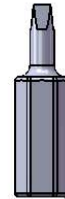

#2 SQUARE
DRIVE BIT
QTY: 1

9

8

7

6

5



4

3

2

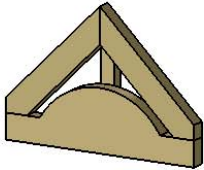
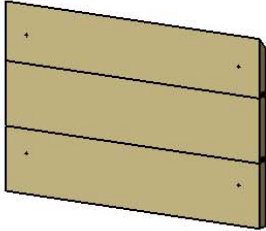
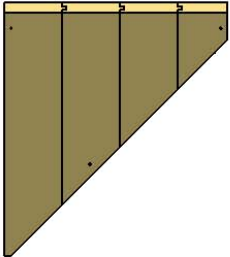
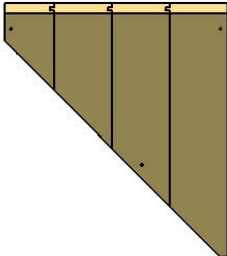
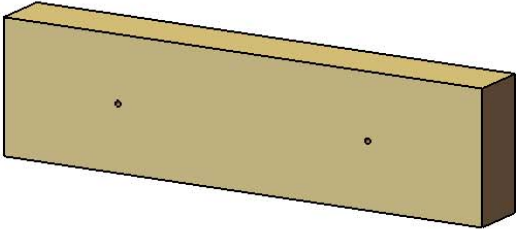
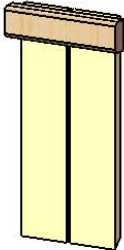
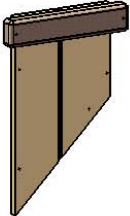
1

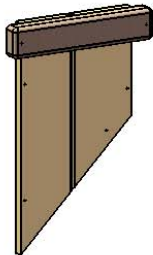
PICTURE	DESCRIPTION	QTY.
	DORMER SUNRAY ASSEMBLY 2-10-1355-DS	4
	DORMER ROOF PANEL ASSEMBLY 2-13-1828-DRPA	4
	DORMER SIDE RIGHT ASSEMBLY 2-17-1850-DSRA	2
	DORMER SIDE LEFT ASSEMBLY 2-17-1850-DSLA	2
	DORMER MOUNT 2-3-1150-DM	2
	CHIMNEY FRONT ASSEMBLY 2-8-1500-CFA	1
	CHIMNEY RIGHT SIDE ASSEMBLY 2-10-1500-CRS	1

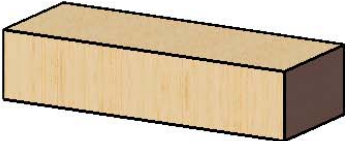
PICTURE	DESCRIPTION	QTY.
	CHIMNEY LEFT SIDE ASSEMBLY 2-10-1500-CLS	1
	CHIMNEY REAR ASSEMBLY 2-8-0700-CRA	1
	CHIMNEY MOUNTING BLOCK 2-3-0675-CMB	1

STEP 1: DORMER SUNRAYS AND SIDES

1: FIND ONE DORMER SIDE LEFT ASSEMBLY AND ONE DORMER SIDE RIGHT ASSEMBLY.

2: FIND TWO DORMER SUNRAY ASSEMBLIES.

3: PLACE THE TWO DORMER SUNRAY ASSEMBLIES BETWEEN THE DORMER SIDE LEFT ASSEMBLY AND DORMER SIDE RIGHT ASSEMBLY. ONE DORMER SUNRAY ASSEMBLY FLUSH TO THE FRONT FLAT END OF THE DORMER SIDE ASSEMBLIES AND THE OTHER DORMER SUNRAY ASSEMBLY FLUSH TO THE REAR FLAT END OF THE DORMER SIDE ASSEMBLIES AS SHOWN BELOW.

4: ATTACH THE DORMER SIDE ASSEMBLIES TO THE DORMER SUNRAY ASSEMBLIES WITH #8 X 1-1/2" WOOD.

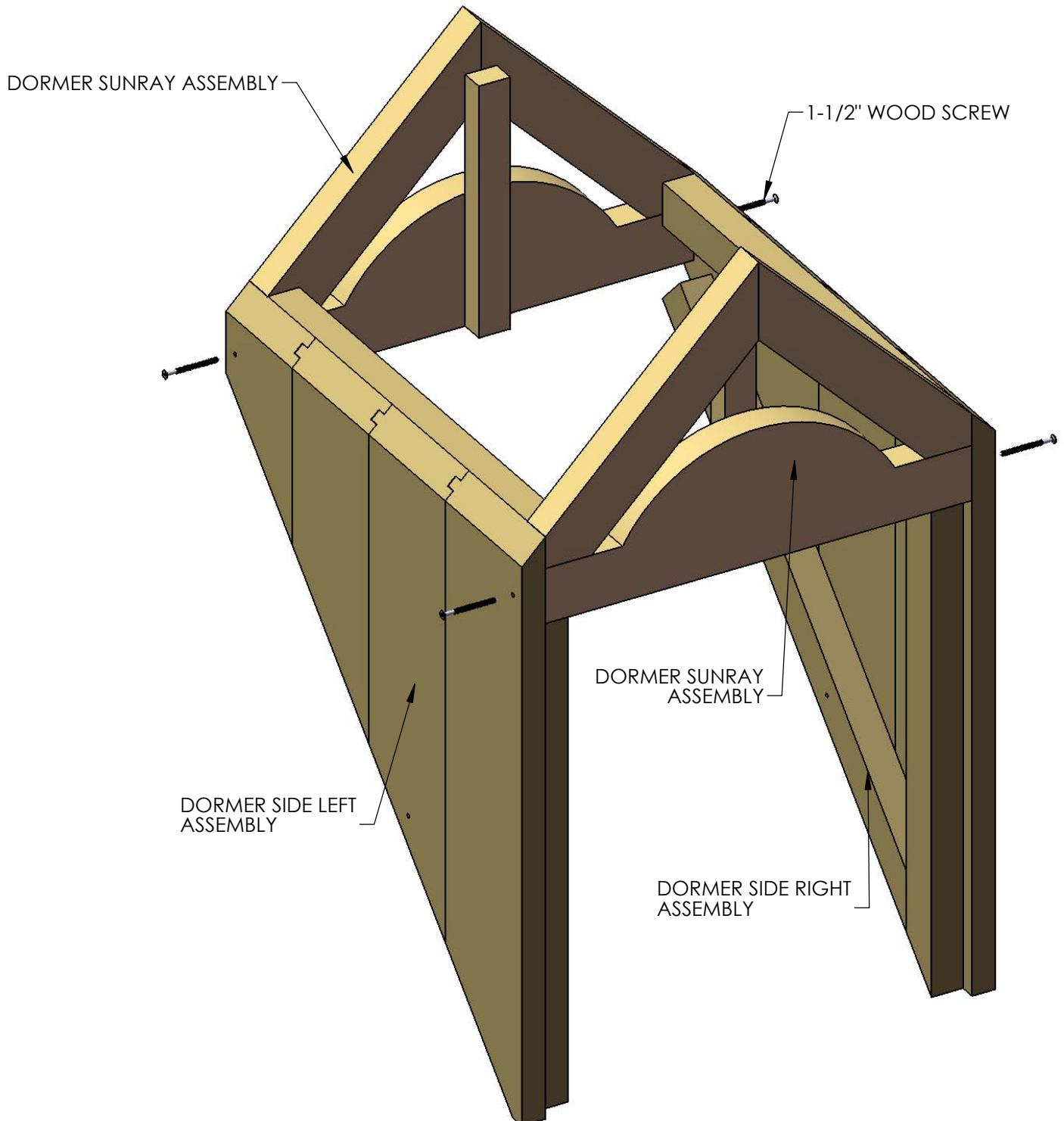

STEP 2: DORMER WINDOW

1: MOUNT THE DORMER WINDOW IN THE FRONT OF THE DORMER, THE WINDOW SHOULD FIT IN BETWEEN THE DORMER SIDES AND THE DORMER SUNRAY. THE BACK FACE OF THE WINDOW MUST BE RESTING AGAINST THE DORMER SIDES BATTENS.

2: MAKE SURE THE HOLES ON THE DORMER WINDOW ARE CENTERED WITH THE DORMER SIDES BATTENS AND THE DORMER SIDES ARE FLUSH TO THE SIDE EDGES OF THE DORMER WINDOW AND FASTEN WITH #8 X 1-1/2" WOOD SCREWS.

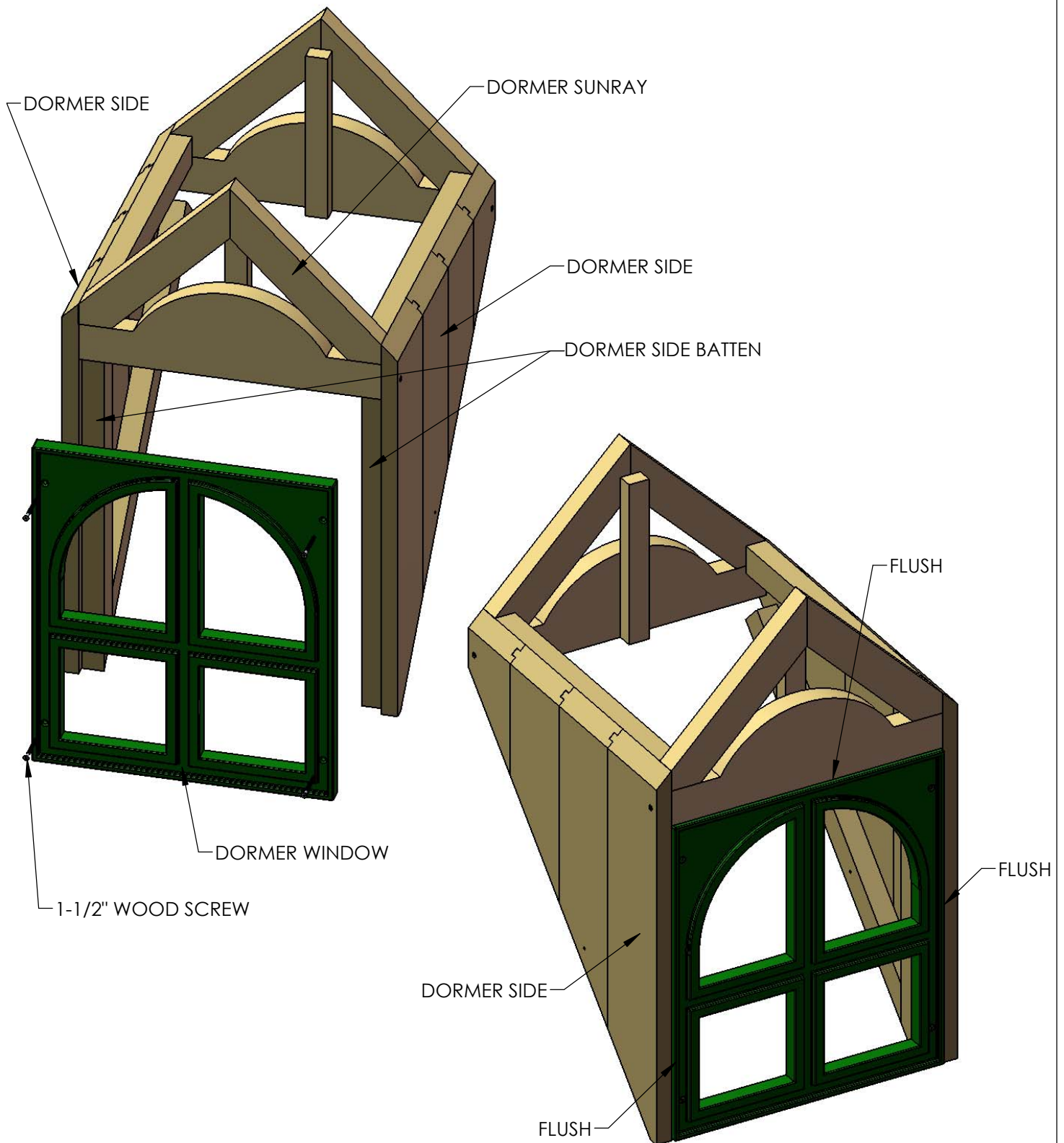

STEP 3: DORMER ROOF PANELS

1: FIND TWO DORMER ROOF PANEL ASSEMBLIES.

2: PLACE ONE DORMER ROOF PANEL ASSEMBLY ON TOP OF THE DORMER SUNRAY ASSEMBLIES, THE ROOF PANEL BOARDS MUST OVERHANG EQUALLY OFF THE FRONT AND BACK, MAKE SURE THE PRE-DRILLED HOLES ON THE ROOF PANEL ARE CENTERED WITH THE TOP FACE OF THE DORMER SUNRAY ASSEMBLIES. FASTEN WITH #8 X 1-1/2" WOOD SCREWS.

3: REPEAT THE PREVIOUS SUB-STEP FOR THE OTHER SIDE.

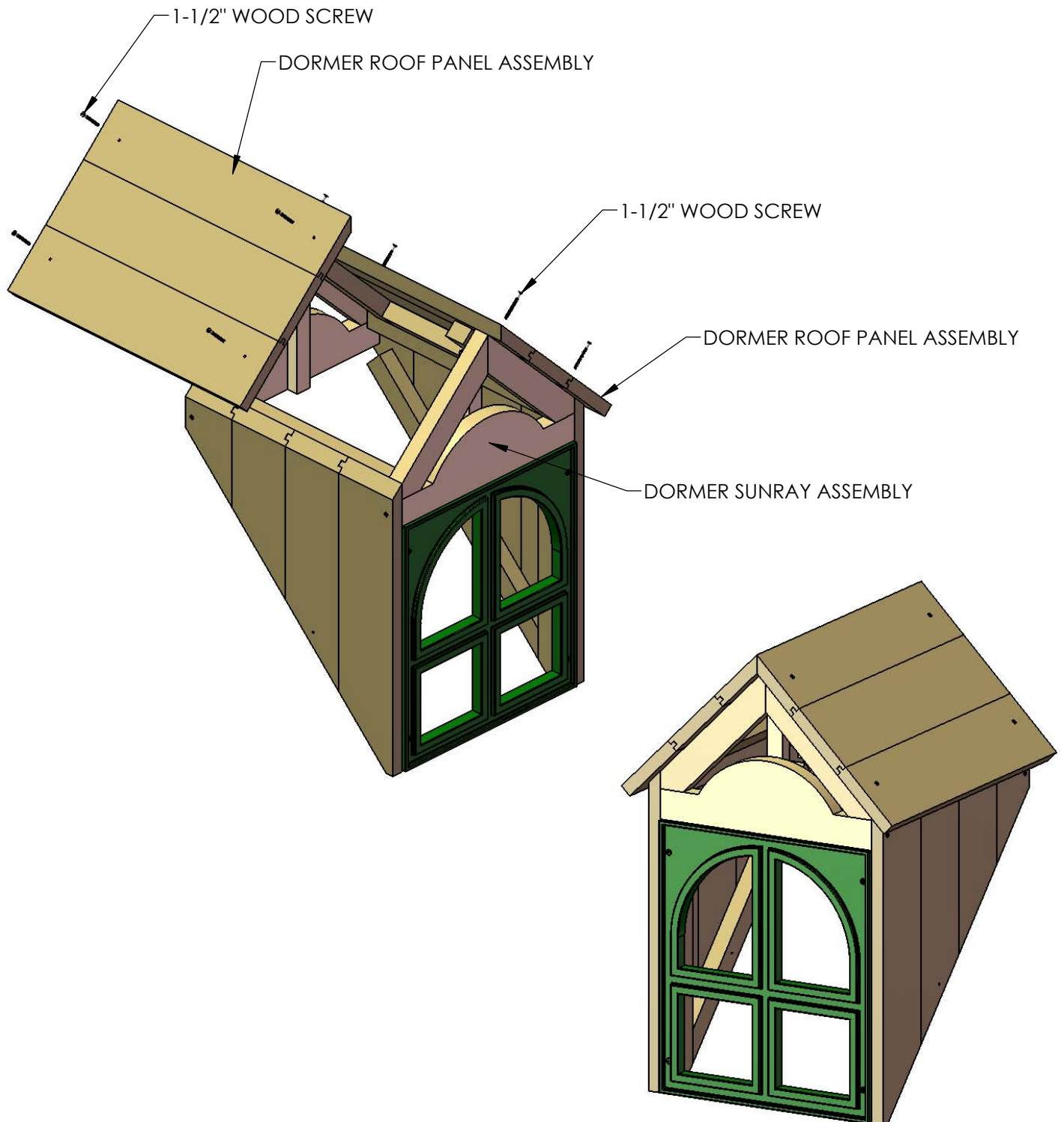

STEP 4: CHIMNEY

1: FIND THE FRONT AND LEFT SIDE OF THE CHIMNEY.

2: ATTACH THE FRONT AND LEFT SIDES OF THE CHIMNEY WITH A 2" WOOD SCREW.

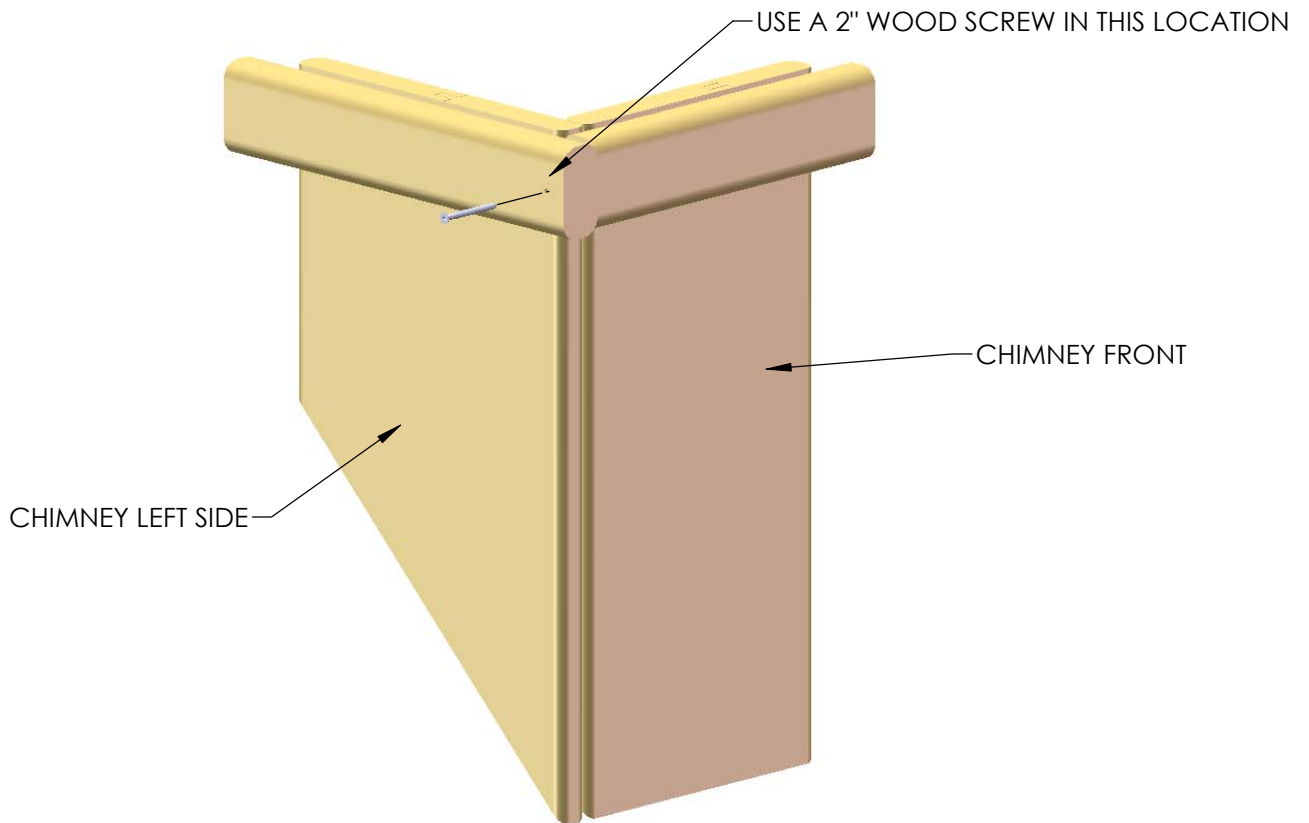

1: FIND THE REAR AND RIGHT SIDE OF THE CHIMNEY.

2: ATTACH THE REAR AND RIGHT SIDES OF THE CHIMNEY WITH A 2" WOOD SCREW.

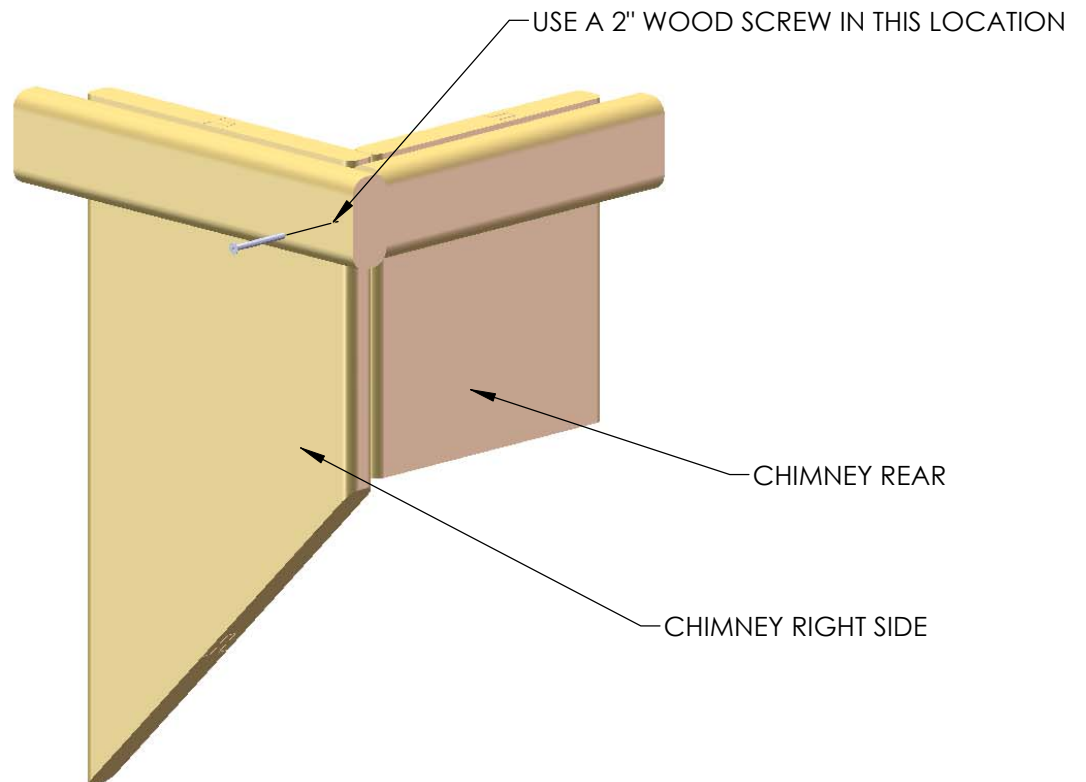

STEP 5: CHIMNEY

1: ATTACH THE CHIMNEY SIDES FROM THE PREVIOUS SIDES TO FORM THE CHIMNEY WITH 2" AND 1-1/4" WOOD SCREWS.

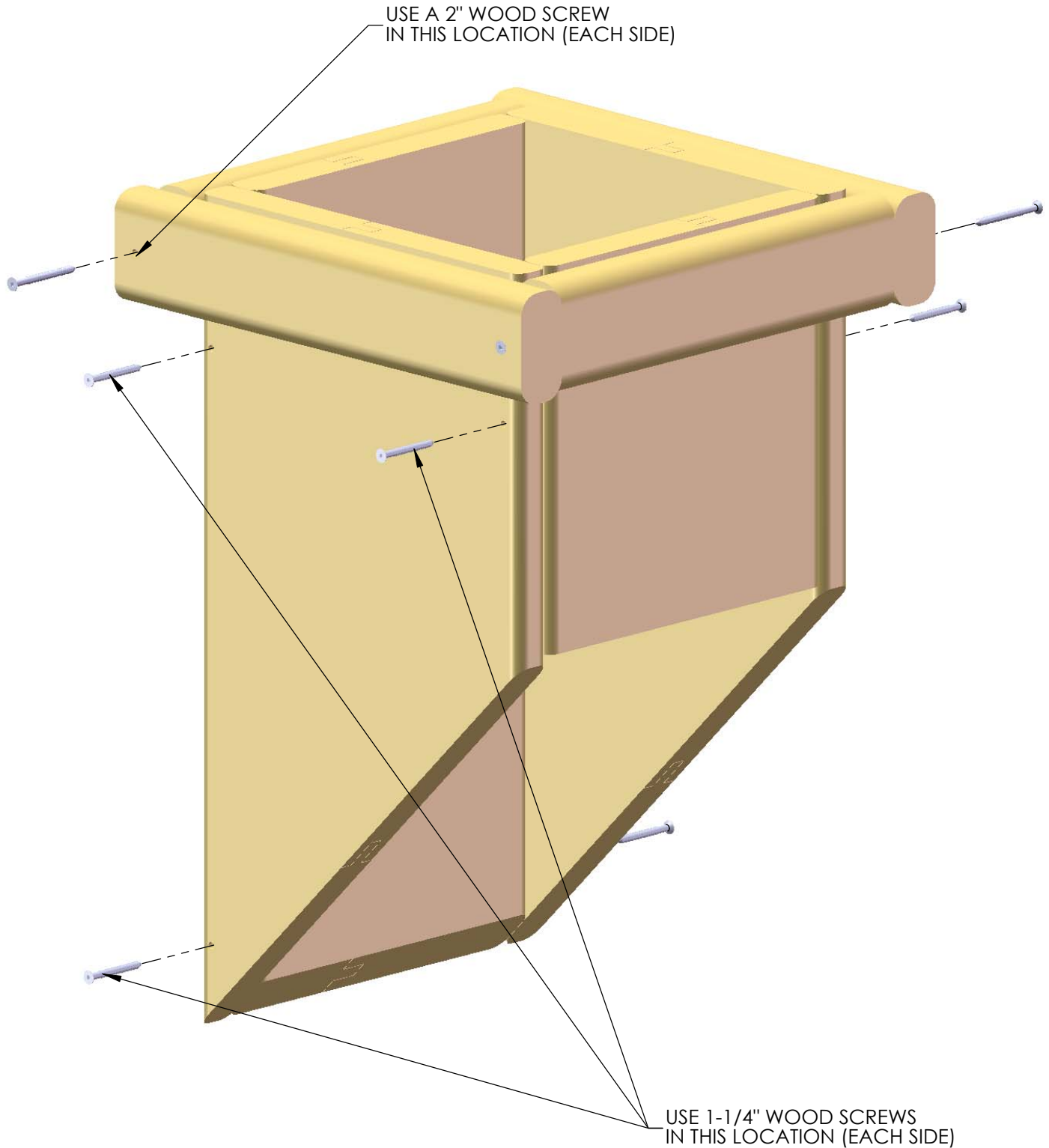

STEP 6: CHIMNEY

1: FASTEN THE 5/4 X 3 X 6-3/4" CHIMNEY MOUNTING BLOCK TO THE ROOF WITH 1-1/2" WOOD SCREWS. YOU CAN PLACE THE BLOCK AT ANY DESIRED PLACE ON THE ROOF. USE THE DIAGRAM BELOW AS A GUIDE AS TO WHERE YOU MIGHT INSTALL YOUR CHIMNEY.

2: AFTER INSTALLING THE CHIMNEY MOUNTING BLOCK, PLACE THE CHIMNEY ASSEMBLY ON THE ROOF SO THAT THE INSIDE OF THE BACK WALL RESTS AGAINST THE BLOCK.

3: FASTEN THE CHIMNEY TO THE CHIMNEY MOUNTING BLOCK WITH A 1-1/2" WOOD SCREW IN EACH SIDE.

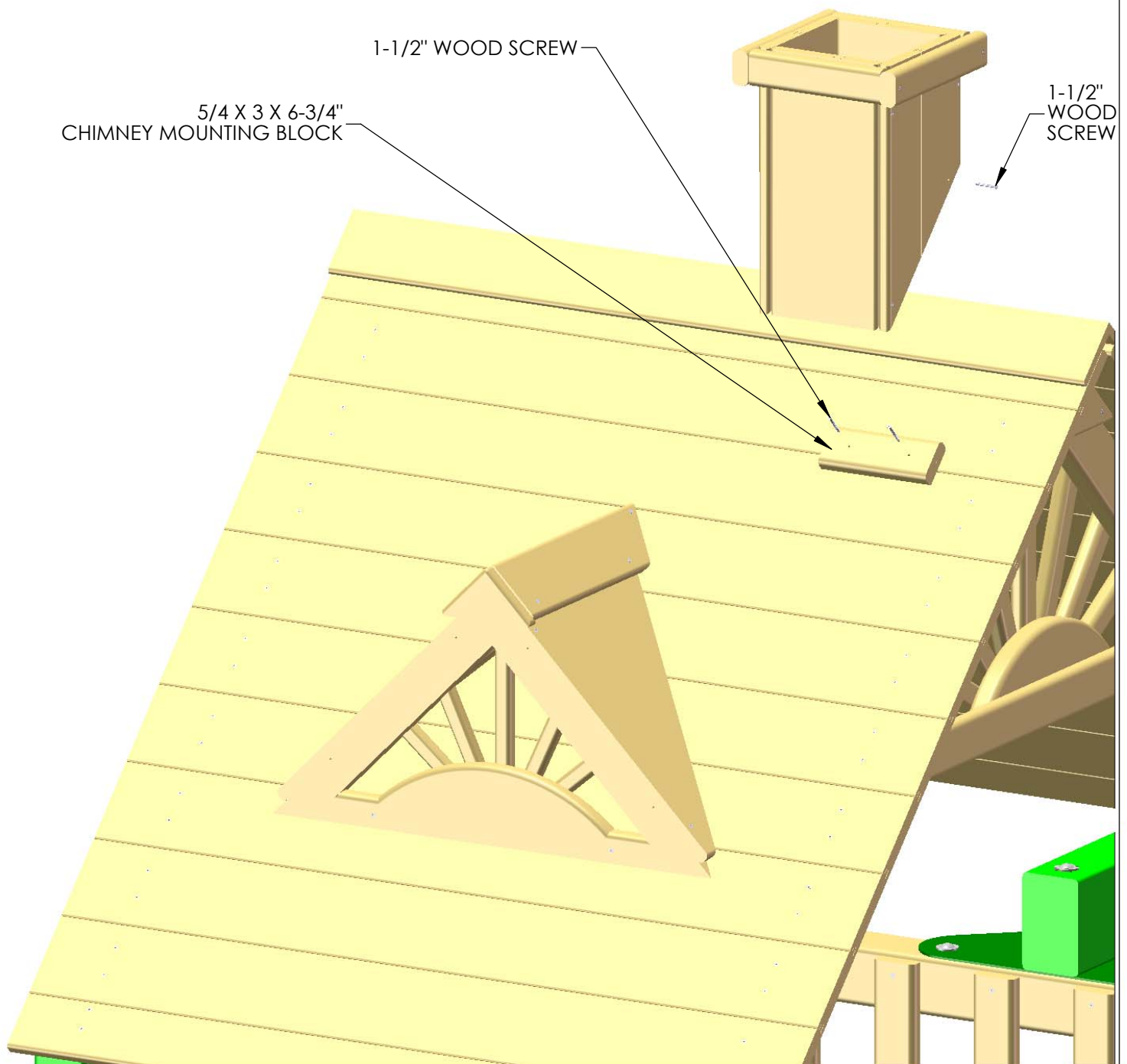

ABOVE UNIT MAY NOT BE YOUR EXACT PLAYSET.
SHOWN FOR ILLUSTRATION PURPOSES ONLY.