

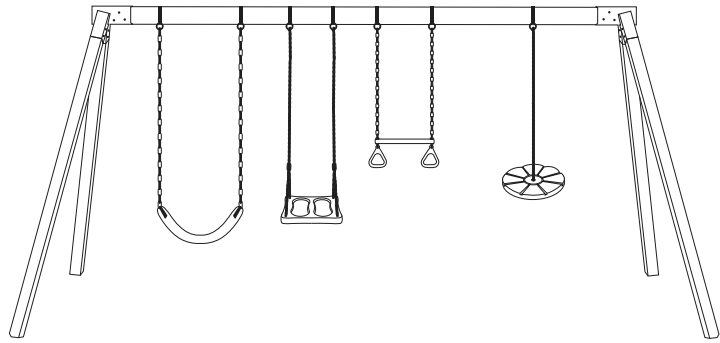

SWINGAN

Manual



DIY SWING SET

It's time to swing!

INTRODUCTION

Dear valued customer

Congratulations! You have purchased the Swingan DIY Swing set, where the fun begins!

Please read this entire booklet completely before beginning the assembly process. We have included important safety information that you must adhere to, to prevent injuries.

PLEASE RETAIN THESE INSTRUCTIONS FOR FUTURE REFERENCE.

KEEP THEM IN A SAFE PLACE WHERE YOU CAN REFER TO THEM AS NEEDED.

TABLE OF CONTENTS

• Instructions for use – Safety Instructions	PAGE 3
• Safe Use	PAGE 4
• Maintenance	PAGE 5
• Swingan Warranty	PAGE 6
• Kit Components	PAGE 7
• Tools Required	PAGE 8
• How to Build	PAGE 9
• Assembling the A Frame	PAGE 9
• Preparing the Swing Hanging Bar	PAGE 10
• Installing the Swing Hanger Screws	PAGE 10
• Attaching the top Beam to the a-frames	PAGE 11
• Assembling the Belt Swing	PAGE 12
• Hanging the Swings	PAGE 12

INSTRUCTIONS FOR USE – SAFETY INSTRUCTIONS

Carefully read the following instructions BEFORE using your Swingan product. This information was meticulously put together for your safety and to reduce risk of injury. Always keep the safety of your children in mind as you build your set and as your children play on it.

SAFETY ADVISORIES

INSTALLATION

- Use a water sealant on your beams to protect the wood and prevent cracking and warping.
- Install the swing set only on a level surface.
- Never install the swing set on a hard surface such as tiles, concrete, packed earth etc. Only install the swing set over a soft and proper shock-absorbent material such as wood chips, mulch or shredded rubber, of sufficient depth – between 9-12". Dirt and grass, which are the most prevalent surfaces under home playground equipment, do not adequately protect children from serious head injuries.
- Do not install loose fill surfacing over hard surfaces such as concrete or asphalt.
- The swing set should be placed at least 6ft from any surrounding structures, and surface material should extend the full 6ft around the swing set in all directions.
- Remove any tripping hazards, such as rocks, tree stumps, loose toys etc. from the play area.
- Always anchor your swing set into the ground to prevent movement and guarantee stability when the swing set is played on.

SAFE USE

- The swing set is designed to be used by children ages 4 and up. No more than 4 persons should use the set at once, not more than one person per swing.
- An adult should always supervise children using the swing set.
- Do not allow a child or adult to use the swing set if they have a physical condition that hampers their ability to use the equipment properly.
- Teach children not to walk close to, in front, in between or behind moving swings.
- Make sure your children know not to jump off a swing that is in motion.
- Teach children not to twist or loop the swing chains/ropes. This may weaken the strength of the chain/rope.
- Teach children to only use each swing in the proper manner it is intended for. Children should learn to sit in the centre of the swing, with their full weight on the seat.
- Instruct children not to push empty seats – the swing may hit them on the rebound, and may cause serious injury.
- All who use the swing set should dress appropriately e.g. avoiding loose strings that could get caught in the swing chains.
- Take care when using the equipment after it has gotten wet, only allow children on the swings when there is sufficient traction for them to be safe.
- No one should use the equipment before you have checked that it is assembled and anchored properly.

MAINTENANCE

- Carry out maintenance checks monthly or before the start of a usage period, checking more regularly in seasons of high usage.
- Inspect nuts and bolts for tightness
- Oil all moving steel parts
- Check water sealant and repaint areas of exposure. We recommend sealing annually to keep your swing set looking brand new.
- Scan for rough areas that may need sanding
- Check that all accessories and parts are in proper working order

For more detailed information on playground safety, download the United States Consumer Product Safety Commission's Outdoor Home Playground Safety Handbook at no cost:

<https://www.cpsc.gov/s3fs-public/324.pdf>

Check the swing equipment before each use, and perform maintenance regularly. This includes, but is not limited to checking the swing set for cracks, breaks, missing pieces, excess wear, loose connections, decreased stability and for overall integrity.

SWINGAN WARRANTY

S
W
I
N
G
A
N
W
A
R
R
A
N
T
Y

Swingan products are manufactured under the highest standards of quality and workmanship. Your Swingan item comes with a limited warranty showing our dedication to providing only quality products.

Our warranty covers defects in material and workmanship. Allowing for reasonable wear and tear, should any such defect become apparent during the warranty period, Swingan will supply a free replacement for any defective part (installation not included). This limited warranty does not cover damage incurred through regular wear and tear, improper maintenance, abuse and misuse, commercial use or accidents.

The warranty is effective from the date of purchase as shown on your receipt, and in accordance with the applicable legalities of your state and/or region. All parts of this swing set are under warranty for 1 year from the date of purchase.

After the warranty expires, we offer a 15% discount on all our replacement parts, up until 2 years from the original purchase date. Customers must show proof of purchase in order to receive this discount. We make every effort to ensure that we ship our products in perfect condition. In the event that you receive your swing or ladder with any of the parts missing or broken, contact Swingan customer service for immediate replacement at no cost to you.

If you made an error when purchasing your swing, ladder, or part, we will gladly make an exchange. However, you will be responsible for any shipping charges required for the exchange.







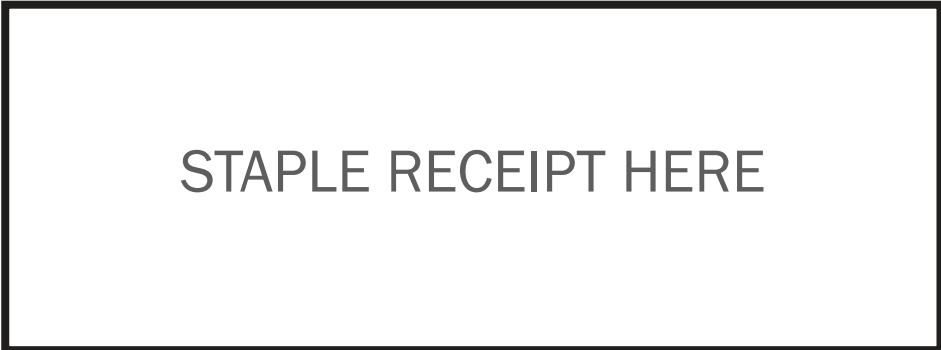

FOR YOUR RECORDS:

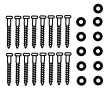
Please take the time to enter the information below. You will need this information for warranty claims.

Place of Purchase: _____ Date of Purchase: _____



KIT COMPONENTS

Part	Description	Quantity
	A-Frame Bucket	2
	Bracket Hardware	2
	Belt Swing Seat	1
	Coated Chains	2
	Fully Assembled Trapeze Bar with Rings	1
	Fully Assembled Disc Swing	1
	Fully Assembled Standing Swing	1
	Screw Swing Hanger	7
	Snaphook	7

TOOLS REQUIRED

1.

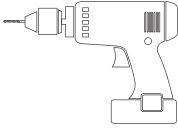

ELECTRIC DRILL

6.

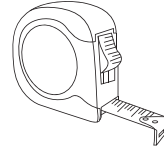

TAPE MEASURE

2.

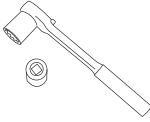

SOCKET & WRENCH

7.

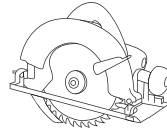

CIRCULAR SAW

3.

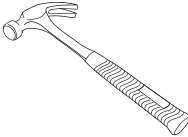

HAMMER

8.

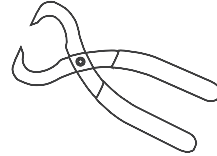

PLIERS

4.

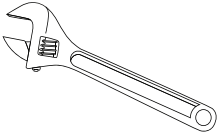

WRENCH

9.

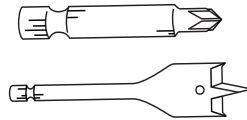

PHILIPS BIT & SPADE BIT

5.

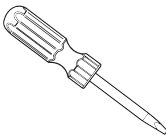

SCREWDRIVER

10.

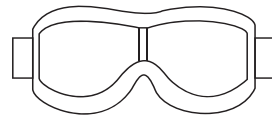

SAFETY GLASSES

Before starting assembly, check that you have all necessary parts. If any parts are missing or damaged on delivery, please contact Swingan customer support directly on 1-800-574-9323 for immediate replacement.

HOW TO BUILD YOUR SWING SET

In order to build this swing set you must purchase wooden beams. The A-frame brackets are designed to be used with a 4x6 top beam and 4x4 support beams. To build the swing set according to our design and safety specifications you should use a 12ft top beam and 8ft side support beams. This will create a play set with final dimensions of approximately 12ft length, 8ft depth and 7.8ft height.

Before building this swing set, check that you have a minimum space of 24ft by 20ft, to ensure at least 6ft of space on each side of the set.

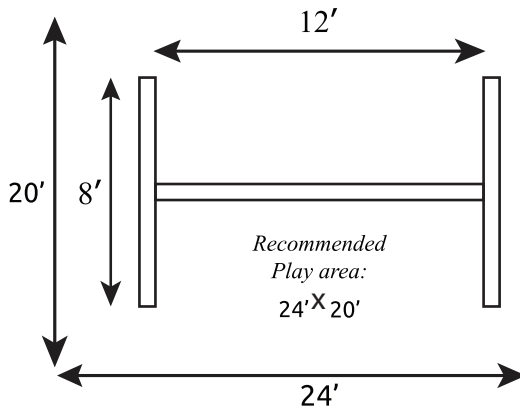

ASSEMBLING THE A-FRAME

1. Measure the two 4"x4"x8' beams to ensure that they are the same length, adjusting as needed. Lay the two beams on a level surface and slide the top ends into the leg openings on the A-frame bracket. These are the two shorter openings.
2. Secure the bracket to the beams using 4 lag bolts and washers for each beam. Drive the bolts through the ready holes of the bracket firmly into the wooden beam, 2 on each side of each beam. (Pre-drilling holes smaller than the bolts before screwing the bolts in may allow easier securing with less risk of splintering the wood.)
3. Repeat steps 1 and 2 for the other bracket, so you now have two V-shaped leg frames.

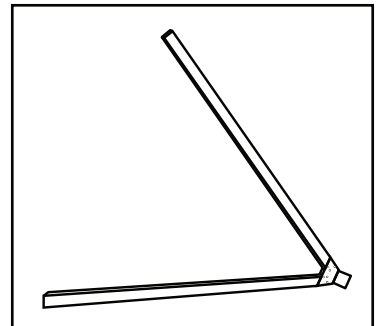

PREPARING THE SWING HANGING BAR

- Measure and mark the 120" top beam for placement of the swings. Make the markings on the 4" surface of the beam. Mark each spot where a swing hanger screw must be installed to hang a swing chain on. See the diagram below for the measurements of how to place your swings in accordance with safety requirements. Dotted lines indicate where markings must be made.

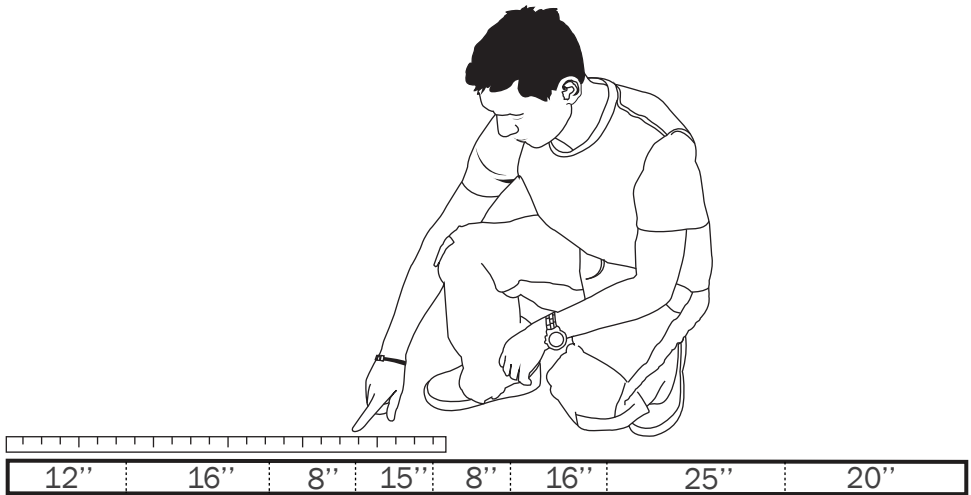

- Drill holes through the beam using a 3/8" drill bit. Drill through the full 6" of the wood, at 90° angles to the beam. Drill a hole at each marked spot.

INSTALLING THE SWING HANGER SCREWS

1. Place a washer on each end the drilled hole, flush with the wood.
2. Slide the screw hanger through the first washer, through the beam and through the second washer.
3. Tighten the screw in place using the two accompanying nuts, screwing them onto the top of the screw hanger on the other side of the beam.
4. Repeat steps 1-3 at each drilled hole and swing hanger screw.

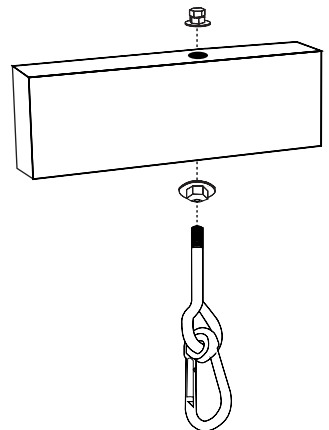

ATTACHING THE TOP BEAM TO THE A-FRAMES

NOTE: YOU WILL REQUIRE THE ASSISTANCE OF ANOTHER PERSON FOR THIS PART OF THE ASSEMBLY.

1. Lay the top beam on the ground on a 6" side, with the screw hangers on the side closer to you.
2. Stand one A-Frame on its side, with one beam flat on the ground and the other in the air. The legs should be pointing in the same direction as the swing hangers. (See Image)
3. Lift the top beam slightly and tilt it so that it can slide into the opening on the A-Frame bracket. Slide the top beam into opening of the bracket.
4. Secure the bracket to the beams using 6 lag bolts and washers for each beam, 3 on each side. Drive the bolts through the ready holes of the bracket firmly into the wooden beam. (Pre-drilling holes smaller than the bolts before screwing the bolts in may allow easier securing with less risk of splintering the wood.)
5. Repeat steps 2-4 for the second A-Frame at the other end of the top beam.
6. Together with your assistant, lift the top beam off the ground by holding the two A-Frame brackets. Lift the beam until it is above the two support frames, and the support frames rest firmly on the ground.
7. Check that your swing frame is standing firm and stable. Add stakes for a stronger grounding if desired.

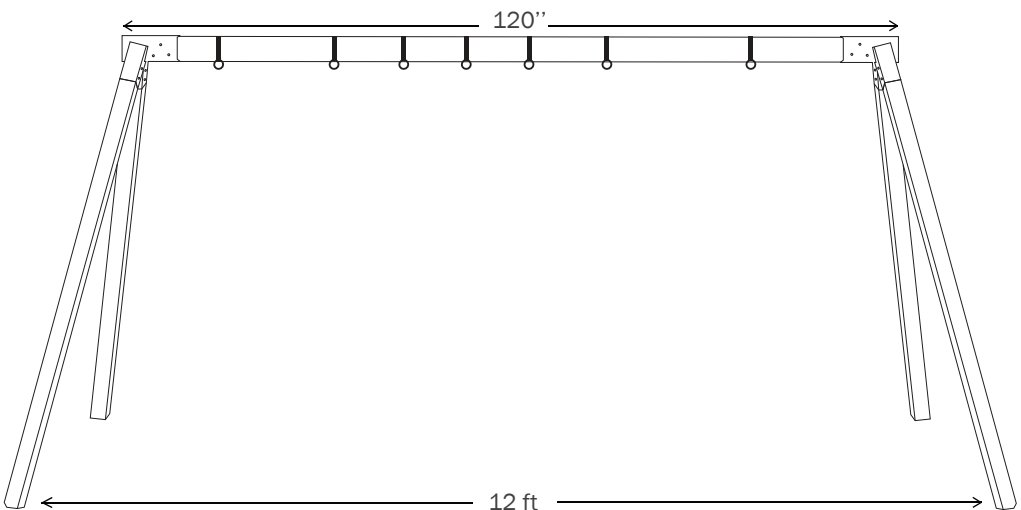

You are now ready to start hanging your swings!

ASSEMBLING THE BELT SWING

1. Collect the belt swing seat and the two coated chains.
2. Thread the S-Hook on the end of a chain through the hole on one end of the swing seat.
3. Crimp the hook opening closed using pliers to secure the connection.
(See Image)
4. Repeat steps 2-3 with the S-Hook on the other chain, connecting it to the hole on the other end of the swing seat.

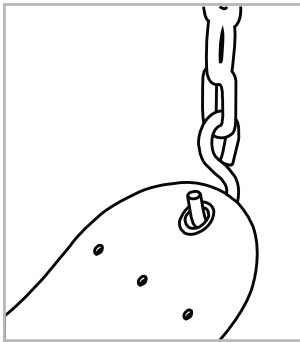

HANGING THE SWINGS

All the swings are now fully assembled. Using the snap hooks at the top of each chain or rope, hook each swing onto the swing hanger snap hooks, at its designated spot. See the image below for the position of each swing.

(Image not drawn to scale.)

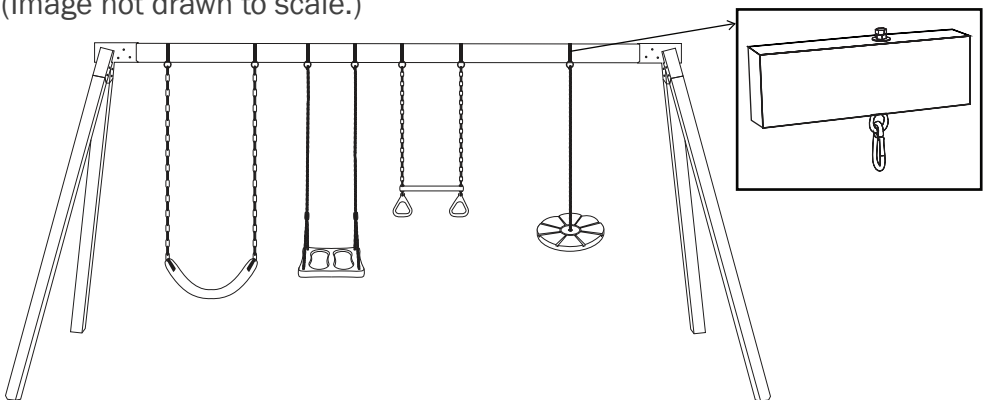

NOTE: There must be a minimum of 8" clearance space between the bottom of each swing and the floor. Adjust each swing to the desired height and ...
have fun swinging!

Your swingset
is fully assembled
and
ready for FUN!

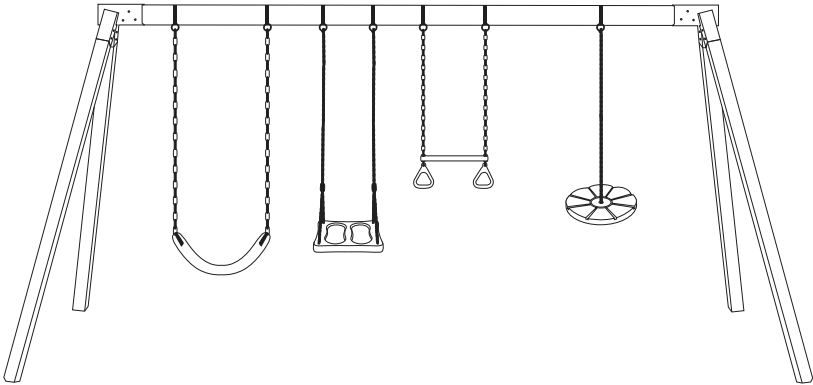

CONTACT INFO:

☎ US: 1800-574-9323
UK: 020-3150-0484
✉ Support@swingan.com

🏠 2 Mill St. Cornwall NY 12518
🌐 Web: www.swingan.com

SWINGAN