

GEN2200DFI

2200 SURGE WATTS / 1800 RUNNING WATTS

DUAL FUEL LPG LIQUID PROPANE & GASOLINE

INVERTER PORTABLE GENERATOR

INSTRUCTION MANUAL



READ ALL INSTRUCTIONS AND WARNINGS BEFORE USING THIS PRODUCT.

This manual provides important information on proper operation & maintenance. Every effort has been made to ensure the accuracy of this manual. These instructions are not meant to cover every possible condition and situation that may occur. We reserve the right to change this product at any time without prior notice.

**IF THERE IS ANY QUESTION ABOUT A CONDITION BEING SAFE OR UNSAFE,
DO NOT OPERATE THIS PRODUCT!**

Visit our website for Frequently Asked Questions <http://sportsmanseriesbrand.com>

DO NOT RETURN THIS GENERATOR TO THE RETAILER!

If you experience a problem, have questions or need parts for this product, call Customer Service at 1-866-460-9436, Monday-Friday, 8 AM - 4 PM Central Time. A copy of the sales receipt is required.

FOR CONSUMER USE ONLY – NOT FOR PROFESSIONAL USE.

KEEP THIS MANUAL, SALES RECEIPT & APPLICABLE WARRANTY FOR FUTURE REFERENCE.

DANGER CARBON MONOXIDE

Using a generator indoors CAN KILL YOU IN MINUTES

Generator exhaust contains carbon monoxide (CO). This is a poison you cannot see or smell. If you can smell the generator exhaust, you are breathing CO. But even if you cannot smell the exhaust, you could be breathing CO.

- NEVER use a generator inside homes, garages, crawlspaces, or other partly enclosed areas. Deadly levels of carbon monoxide can build up in these areas. Using a fan or opening windows and doors does NOT supply enough fresh air.
- ONLY use a generator outside and far away from windows, doors, and vents. These openings can pull in generator exhaust.

Even when you use a generator correctly, CO may leak into the home. ALWAYS use a battery-powered or battery-backup CO alarm in the home.

WARNING!

California Proposition 65

Engine exhaust and some of its constituents are known to the state of California to cause cancer, birth defects, and other reproductive harm.

ADVERTENCIA!

Proposición 65 de California

El escape del motor y algunos de sus constituyentes se reconocen en el estado de California como causante de cáncer, defectos de nacimiento y otros daños reproductivos.

WARNING!

California Proposition 65

This product contains or emits chemicals known to the state of California to cause cancer, birth defects, and other reproductive harm.

ADVERTENCIA!

Proposición 65 de California

Este producto contiene o emite químicos que en el estado de California como causante de cáncer, defectos de nacimiento y otros daños reproductivos.

Model GEN2200DF 2200 Surge Watts / 1800 Running Watts

This unit is a Dual Fuel LPG or Gasoline Fuel powered Inverter generator.

FEATURES:

- 2200 Surge Output / 1800 Running Watts*
 - 120V Operation
 - 3.0 HP Engine, 4 Stroke , 4650 RPM
 - Displacement (CC): 79.7
 - Low Oil Shut Off
 - UL Listed Electrical Components
 - Engine Shut Off Switch
 - Power Outlets
 - Spark Plug Model A7RTC
 - 1-12V DC Outlet
 - 2-120V Outlets
 - Parallel Outlet
 - 1 Gallon Max Capacity Gasoline Fuel Tank
 - Complies with EPA & CARB emissions
 - Decibel Rating < 53 db 0% load measured at 23 feet
 - Run time =7 hrs @ 50% load Gasoline
 - Run time =18 hrs @ 50% load LPG with 20 lbs tank
 - Fuel type - Liquid Propane Gas (also commonly referred to as LP, LPG and Propane) Or Unleaded Gasoline
 - If you are using a generator above sea level, the generator may not function properly because of air flow getting through the mixer.
 - High Altitude Use: This generator is not recommended for high altitude use above 3,000 feet.
 - **Propane Tank Not Included**
 - If you want to use a propane tank larger than 20 lbs, call Customer Service for details at 866-460-9436.
- * SURGE WATTS / RUNNING WATTS MAY BE REDUCED BY 10% WHEN USING PROPANE FUEL VS USING GASOLINE.**



2 YEAR LIMITED EMISSION-RELATED WARRANTY

THIS ENGINE MEETS U.S. EPA EMISSION STANDARDS UNDER 40 CFR 1054.625 .The emission-related limited warranty is valid for two (2) years. Keep the purchase receipt and mail in the product registration card for proof of purchase. Buffalo Corp limits emission-related warranty repairs to authorized service centers for owners located within 100 miles of an authorized service center. For owners located more than 100 miles from an authorized service center, Buffalo Corp will, in its sole discretion, either pay for shipping costs to and from an authorized service center, provide for a service technician to come to the owner to make the warranty repair, or pay for the repair to be made at a local non-authorized service center. The provisions of this paragraph apply only for the contiguous states, excluding the states with high-altitude areas identified in 40 CFR part 1068, Appendix III.

To exercise this warranty, DO NOT RETURN TO RETAILER. Instead, call Customer Service toll free at 1-866-460-9436 (email address info@buffalotools.com) and you will be instructed on where to take the engine for warranty service. Take the generator and proof of purchase (your receipt) to the repair facility recommended by the Customer Service Representative. The warranty does not extend to generators damaged or affected by fuel contamination, accidents, neglect, misuse, unauthorized alterations, use in an application for which the product was not designed and any other modifications or abuse.

1 YEAR LIMITED WARRANTY (30 Day Limited Warranty for Commercial and Rental Purpose)

Generators are warranted to be free from defects in materials and workmanship for a period of 1 YEAR from date of original purchase. Buffalo Corp. is not liable for any indirect, incidental or consequential damages from the sale or use of this product. Any implied warranties are limited to 1 YEAR as stated, or as otherwise stated, in this written limited warranty. Some states do not allow the exclusion or limitation of incidental or consequential damages. Some states do not allow limitation on the length of an implied warranty. Buffalo Corp will repair or replace, at its discretion, any part that is proven to be defective in materials or workmanship under normal use during the 1 YEAR warranty period. Warranty repairs or replacements will be made without charge for parts or labor. Parts replaced during warranty repairs will be considered as part of the original product and will have the same warranty period as the original product. This warranty gives you specific legal rights, and you may have other rights that vary state to state

TABLE OF CONTENTS

RECOGNIZE SAFETY SYMBOLS, WORDS AND LABELS.....	5
PACKAGE CONTENTS	
PACKAGE CONTENTS	10
COMPONENTS	11
PREPARING THE GENERATOR FOR USE	11
Using This Generator For The First Time.....	12
Step 1 – Add Oil	12
Step 2 – Connect Fuel.....	13
Step 3 – Ground The Generator.....	14
Subsequent Use Of This Generator.....	14
Step 1 – Verify Oil Level	14
Step 3 – Ground The Generator.....	15
STARTING THE GENERATOR.....	15
USING THE GENERATOR.....	16
AC Usage.....	16
AC Parallel Usage.....	18
DC Usage.....	19
STOPPING THE GENERATOR.....	19
MAINTENANCE/CARE	20
Recommended Maintenance Schedule	20
Cleaning The Generator.....	20
Checking The Oil Level	20
Changing/Adding Oil	21
Air Filter Maintenance	22
Spark Plug Maintenance	22
Spark Arrestor	23
Changing Fuel Line	23
Fuel Tank Usage & Maintenance.....	23
STORAGE/TRANSPORT PROCEDURES	23
TROUBLESHOOTING	24
SPECIFICATIONS	25
PARTS DIAGRAM	26
WIRING DIAGRAM	30
EMISSIONS CONTROL SYSTEM WARRANTY	31

RECOGNIZE SAFETY SYMBOLS, WORDS AND LABELS

What You Need to Know About Safety Instructions

Warning and Important Safety Instructions appearing in this manual are not meant to cover all possible conditions and situations that may occur. Common sense, caution and care must be exercised when operating or cleaning tools and equipment.

Always contact your dealer, distributor, service agent or manufacturer about problems or conditions you do not understand.



This is the safety alert symbol. It is used to alert you to potential personal injury hazards. Obey all safety messages that follow this symbol to avoid possible injury or death.



DANGER indicates an imminently hazardous situation which, if not avoided, will result in death or serious injury.



WARNING indicates a potentially hazardous situation which, if not avoided, could result in death or serious injury.



CAUTION indicates a potentially hazardous situation which, if not avoided, may result in minor or moderate injury.



CAUTION used without the safety alert symbol indicates a potentially hazardous situation which, if not avoided, may result in property damage.

High Altitude Use:

This generator is not recommended for high altitude use above 3,000 feet.

Legal Requirements:

Federal and/or State Occupational Safety and Health Administration (OSHA) regulations, local codes, and/or ordinances may apply to the intended use of this generator. Consult a qualified electrician, electrical inspector, and/or the local agency having jurisdiction. Some areas require generators to be registered with local utility companies. Additional regulations may apply if this generator will be used at a construction site.

IMPORTANT SAFETY INSTRUCTIONS

STOP!

Before using this generator and if you have any questions regarding the hazard and safety notices listed in this manual and/or on this generator, call 1-866-460-9436, Monday - Friday, 8 AM - 4 PM Central Time.

DANGER

Carbon Monoxide Gas: When in operation, the exhaust from this generator contains poisonous carbon monoxide gas. Carbon monoxide gas is both odorless and colorless AND may be present even if you do not see or smell gas. Breathing this poison gas can lead to headaches, dizziness, drowsiness, loss of consciousness and eventually death.

- Use this generator ONLY outdoors in non-confined areas.
- Keep at least several feet of clearance on all sides to allow proper ventilation for this generator.

WARNING

Chemicals: According to the State of California, the exhaust from this generator contains chemicals known to cause cancer, birth defects, or other reproductive harm.

WARNING

Propane (LPG): This generator may emit highly flammable and explosive vapors, which can cause severe burns or even death. A nearby open flame can lead to an explosion even if not directly in contact the fuel.

- Do not operate this generator near open flame.
- Always operate this generator on a firm, level surface.

This fuel is highly flammable and explosive. Handling fuel can result in serious injury or burns.

- Before starting the generator, inspect your LPG tank valve for damage or leaks, attach only approved tanks that have been properly filled by an approved station. DO NOT light or smoke cigarettes.

Replace the hose at the first sign of a leak or if age-cracking becomes apparent.

- Always handle propane fuel and generator outdoors.
- Before transporting, turn the fuel valve to the "off" position and disconnect the spark plug.

DANGER

Powerful Voltage: This generator produces powerful voltage, which can result in electrocution.

- ALWAYS ground this generator before using it. (See "Ground the Generator" section in this manual).
- Only electrical devices should be plugged into this generator, either directly or with an extension cord. NEVER connect a building electrical system to this generator without a qualified electrician. **Doing so voids your warranty.** Such connections must isolate generator power from utility power and comply with local electrical laws and codes. Failure to comply can create a back feed into utility lines creating an electrocution hazard, which may result in serious injury or death to utility workers. Such a back feed may cause this generator to explode, burn and create fires when utility power is restored.
- Do not use this generator in wet conditions (rain, snow, active sprinkler system, wet hands, etc.). Always keep this generator dry and operate it with dry hands.
- Do not touch bare wires or outlets (receptacles).
- Do not allow children or non-qualified persons to operate this generator.

DANGER

High Temperatures: This generator produces heat when in operation. Temperatures near the exhaust can exceed 150 Degrees Fahrenheit (65 Degrees Celsius).

- Do not touch hot surfaces. Observe all warning placards on this generator denoting hot surfaces.
- Allow this generator to cool for several minutes after use before touching the engine, muffler or other areas that are hot during operation and before storing indoors.
- Hot exhaust may ignite some materials. Keep flammable materials away from this generator.
- Keep at least several feet of clearance on all sides of this generator during operation. Do not enclose this generator in any structure.

⚠ WARNING

Usage: Avoid the use of extension cords if possible. If you choose to use them, be sure they are sized adequately to handle the flow of electricity. An undersized cord can overheat, short out and cause a fire.

⚠ CAUTION

Usage: Misuse of this generator can damage it or shorten its life.

- Use this generator only for its intended purpose.
- Operate this generator only on a dry, level surface.
- Allow this generator to run for several minutes before connecting any electrical devices.
- Promptly turn off any malfunctioning devices and disconnect them.
- Do not operate an excessive number of electrical devices in excess of the wattage capacity of this generator.
- Do not turn on electrical devices until *after* they are connected to this generator.
- Turn off all connected electrical devices before stopping this generator.

⚠ DANGER

Flammable liquid gas under pressure. Can form explosive mixtures with air. May cause frostbite. **In Case Of Inhalation:** Persons suffering from lack of oxygen should be removed to fresh air. If victim is not breathing, administer artificial respiration. If breathing is difficult, administer oxygen. Obtain prompt medical attention. **In Case Of Eye Contact:** Contact with liquid or cold vapor can cause freezing of tissue. Gently flush eyes with lukewarm water. Obtain medical attention immediately. **In Case Of Skin Contact:** Contact with liquid or cold vapor can cause frostbite. Immediately warm affected area with lukewarm water not to exceed 105°F (40°C). **Fire And Explosion Hazards:** Propane is easily ignited. It is heavier than air, therefore, it may collect in low areas or travel along the ground where an ignition source may be present. Pressure in a container can build up due to heat, and it may rupture if pressure relief devices should fail to function. **Storage:** Cylinders should be stored upright with valve protection cap in place and firmly secured to prevent falling or being knocked over. Protect cylinders from physical damage; do not drag, roll, slide or drop. Use a suitable hand truck for cylinder movement. Post "No Smoking or Open Flames" signs in the storage areas. There should be no sources of ignition. All electrical equipment should be explosion proof in the storage and use areas. Storage areas must meet national electric codes for class 1 hazardous areas.

⚠ DANGER

Propane smells like rotten eggs, a skunk's spray, or a dead animal. IF YOU SMELL GAS- NO FLAMES OR SPARKS! Immediately put out all smoking materials and other open flames. Do not operate lights, appliances, telephones, or cell phones. - Flames or sparks from these sources can trigger an explosion or a fire.

WHAT IS CARBON MONOXIDE (CO)?

You can't taste or smell CO, but it is a very dangerous gas. High levels of CO can come from appliances that are not operating correctly, or from a venting system or chimney that becomes blocked. CO CAN BE DEADLY! High levels of CO can make you dizzy or sick. In extreme cases, CO can cause brain damage or death.

Symptoms of CO poisoning include: headache, dizziness, fatigue, shortness of breath, and nausea.

IF YOU SUSPECT CO IS PRESENT, ACT IMMEDIATELY!

1. If you or a family member shows physical symptoms of CO poisoning, get everyone out of the building and call 911 or your local fire department.
2. If it is safe to do so, open windows to allow entry of fresh air, and turn off any appliances you suspect may be releasing CO.
3. If no one has symptoms, but you suspect that CO is present, call your propane retailer or a qualified service technician to check CO levels and your propane equipment.

⚠ WARNING

Usage: Consult a physician(s) before using this generator if using a pacemaker. Electromagnetic fields in close proximity to a heart pacemaker could cause a pacemaker to malfunction or fail. Caution is necessary when near the engine's recoil starter.

⚠ CAUTION

Usage: Prolonged exposure to high noise levels can be hazardous to hearing. Always wear ANSI-approved hearing protection when operating or working around the generator when it is running.

⚠ WARNING

THIS GENERATOR PRODUCES HEAT WHEN RUNNING. TEMPERATURES NEAR EXHAUST CAN EXCEED 150°F. (65° C) DO NOT TOUCH HOT SURFACES. PAY ATTENTION TO WARNING LABELS ON THE GENERATOR DENOTING HOT PARTS OF THE MACHINE. ALLOW GENERATOR TO COOL AFTER USE BEFORE TOUCHING ENGINE OR AREAS WHICH HEAT DURING USE.

⚠ WARNING

The engine exhaust from this product contains chemicals known to the State of California to cause cancer, birth defects or other reproductive harm.

⚠ WARNING

EXHAUST CONTAINS POISONOUS CARBON MONOXIDE GAS THAT CAN BUILD UP TO DANGEROUS LEVELS IN CLOSED AREAS. BREATHING CARBON MONOXIDE CAN CAUSE UNCONSCIOUSNESS OR DEATH. Never run the generator in a closed or even partly closed area where people may be present.

⚠ WARNING

THE GENERATOR IS A POTENTIAL SOURCE OF ELECTRICAL SHOCK IF NOT KEPT DRY. Do not expose the generator to moisture, rain or snow. Do not operate the generator with wet hands. READ OWNER'S MANUAL CAREFULLY BEFORE OPERATION.

⚠ DANGER

IMPROPER CONNECTIONS TO A BUILDING CAN ALLOW ELECTRICAL CURRENT TO BACKFEED INTO UTILITY LINES, CREATING AN ELECTROCUTION HAZARD. Connections to a building must isolate generator power from utility power and comply with all applicable laws and electrical codes.

⚠ WARNING

Propane smells like rotten eggs, a skunk's spray, or a dead animal. IF YOU SMELL GAS- NO FLAMES OR SPARKS! Immediately put out all smoking materials and other open flames. Do not operate lights, appliances, telephones, or cell phones. Flames or sparks from these sources can trigger an explosion or a fire.

⚠ WARNING

GASOLINE IS HIGHLY FLAMMABLE AND EXPLOSIVE. YOU COULD BE BURNED OR SERIOUSLY INJURED IF THE GASOLINE IS IGNITED. Before refueling, stop the engine and keep heat, sparks and flame away. Handle fuel only outdoors. Do not fill the fuel tank above the upper limit line. Wipe up spills immediately.

In addition to the previously described safety information, familiarize yourself with all safety and hazard notices on this generator.

⚠ DANGER POISONOUS GAS

Generator exhaust contains toxic carbon monoxide gas. Breathing exhaust can cause loss of consciousness and shortness of breath. NEVER operate generator in poorly ventilated areas.

⚠ WARNING

Risk of electric shock. Do not remove cover. No user serviceable parts inside. Refer servicing to qualified service personnel.

⚠ WARNING! RISK OF ELECTRIC SHOCK

This generator produces high voltage.
 Always ground properly before use.
 Do not connect to any building electrical system.
 Never use in rainy or wet conditions.
 Never touch bare wires or receptacles.
 Never allow children or non-qualified person to operate.



⚠ WARNING

Propane smells like rotten eggs, a skunk's spray, or a dead animal. IF YOU SMELL GAS- NO FLAMES OR SPARKS! Immediately put out all smoking materials and other open flames. Do not operate lights, appliances, telephones, or cell phones. Flames or sparks from these sources can trigger an explosion or a fire.

⚠ CAUTION! HOT EXHAUST

⚠ DO NOT TOUCH

⚠ CAUTION! HIGH TEMPERATURE DO NOT TOUCH

⚠ DANGER

Using a generator indoors CAN KILL YOU IN MINUTES. Generator exhaust contains carbon monoxide. This is a poison you cannot see or smell.

NEVER use inside a home or garage. EVEN IF doors and windows are open.







Only use OUTSIDE and far away from windows, doors, and vents.

PACKAGE CONTENTS

The following items are supplied with this Model GEN2200DFI Portable LP & Gasoline Generator. Verify that all items are included.

STOP!

If there are missing items, call 1-866-460-9436, Monday - Friday, 8 AM - 4 PM Central Time for customer service. **DO NOT RETURN THIS GENERATOR TO THE RETAILER.**

Item List:	
	Set of 2 DC connector wires for charging 12 Volt automotive-type batteries
	Spark plug wrench
	Funnel for adding Oil
	5 Ft. Regulator Hose Kit (YOU MUST USE THE SUPPLIED REGULATOR FOR SAFE OPERATION)
	T Type Wrench
	Sockets
	Crosshead screwdriver

GENERATOR COMPONENTS

Observe the locations and functions of the various components and controls of this generator.

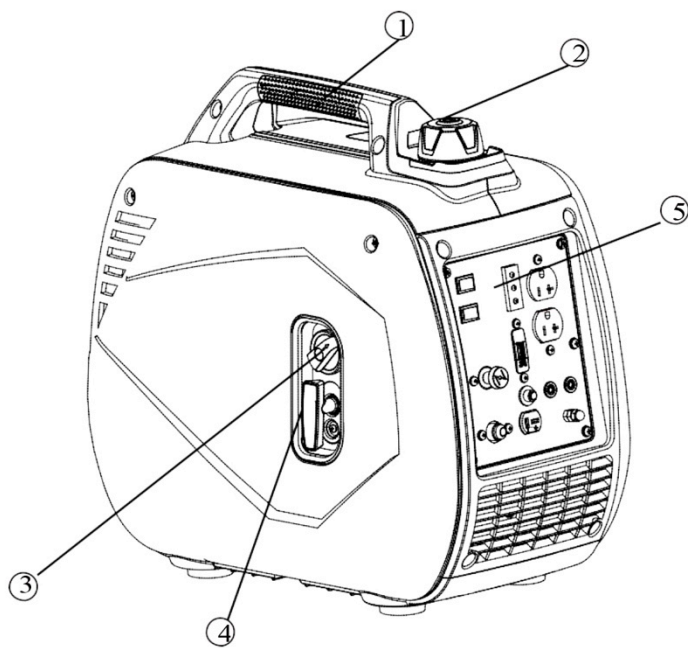

1. Carrying handle
2. Fuel Cap
3. Fuel Switch
4. Recoil Starter Grip
5. Control Panel

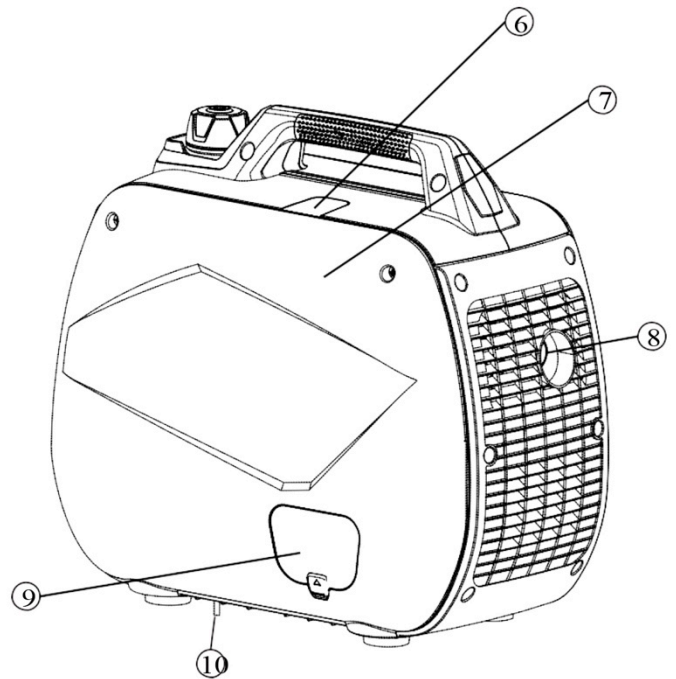

6. Spark Plug Cap
7. Removable Service Panel
8. Muffler
9. Oil Check Access
10. Fuel drain pipe

WARNING:
YOU MUST USE
THE SUPPLIED
REGULATOR FOR
SAFE OPERATION



To prevent electrical shock from faulty appliances, the generator should be grounded. Connect a length of heavy wire between the ground terminal and the ground source.

Consult with a qualified electrician to ensure compliance with local electrical codes.

ATTENTION:

The Air-fuel Mixer is not adjustable. Tampering with the governor can damage your generator and electrical devices, and will void your warranty.

PREPARING THE GENERATOR FOR USE

Using this Generator for the First-Time

STOP!

CAUTION

The following section describes the required steps for preparing this generator for the first use. Failure to correctly perform these steps can damage this generator and/or shorten its life. If still unsure about how to perform any of these steps after reading this section, call 1-866-460-9436 Monday - Friday, 8 AM - 4 PM Central Time for customer service.

If this generator is being used for the first time, the following few steps are required to prepare it for operation:

Step 1 - Add Oil

This generator requires engine oil to function. Engine oil is a major factor affecting engine performance and service life. When new from the package, this generator contains no oil in the engine crankcase. The correct quantity of oil is equal to the oil capacity of the engine crankcase and is 12 fluid oz. Add the correct quantity of oil before operating this generator for the first time. When replenishing oil for subsequent use of this generator, always determine that this generator has the correct quantity of oil.

Model GEN2200DFI Oil Capacity	12 ounces
Model GEN2200DFI Oil Type Recommended	High Detergent Motor Oil, SAE10W-30

To add oil:

1. Confirm that this generator is on a level surface.
2. Unscrew the oil filler/dipstick cap from the engine as illustrated in Figure 1.
3. Using a funnel, add high detergent motor oil to fill the engine crankcase to the correct quantity. SAE10W-30 oil is recommended for general, all-temperature use. **When the engine crankcase is full, the oil level should reach all the way up to the threads** as illustrated in Figure 2.
4. Replace the oil filler/dipstick cap.

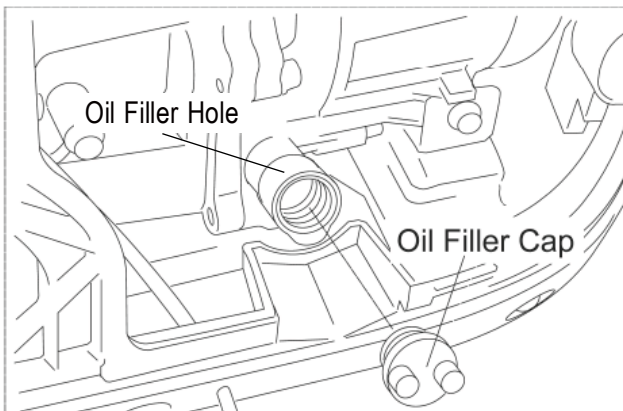

Figure 1 - Unscrew the Oil Cap



Figure 2 - Add Oil To TOP Of Threads

Step 2 – Connect Fuel

⚠ WARNING

Sulfur, water, dust, etc. are harmful for engine. If the gas supply source (LPG) contains these harmful elements, user must use filter to remove sulfur, water etc. and clean gas. Otherwise, the engine service lifetime will be shortened.

Choose either LPG or Gasoline fuel. If using LPG, first connect the regulator that was included with the generator to Propane Fuel Tank, then connect the other end to the Gas Inlet. (Fig A) Make sure the LPG cylinder is vertical and securely positioned

If using gasoline fuel, add Unleaded gasoline only with an octane rating of 87 or higher.
Maximum Capacity: 1.0 Gallons

Pre-Operation Check List

Step 1 Check that the gas supply source is in good condition. Check that the gas inlet connection is tightly fixed and not leaking.

Step 2 CHOKE VALVE GRIP is at CHOKE (CLOSE) position. The generator may be hard to start if CHOKE VALVE GRIP is at RUN (OPEN) position.

Step 3 Check if engine oil is full.

Step 4 Make sure GROUND TERMINAL is properly grounded.

Step 5 AC OUTPUT no load connected.
Disconnect all electrical loads from the generator set before starting the engine. The generator may be hard to start if a load is connected.

Step 6 DC OUTPUT no load connected.

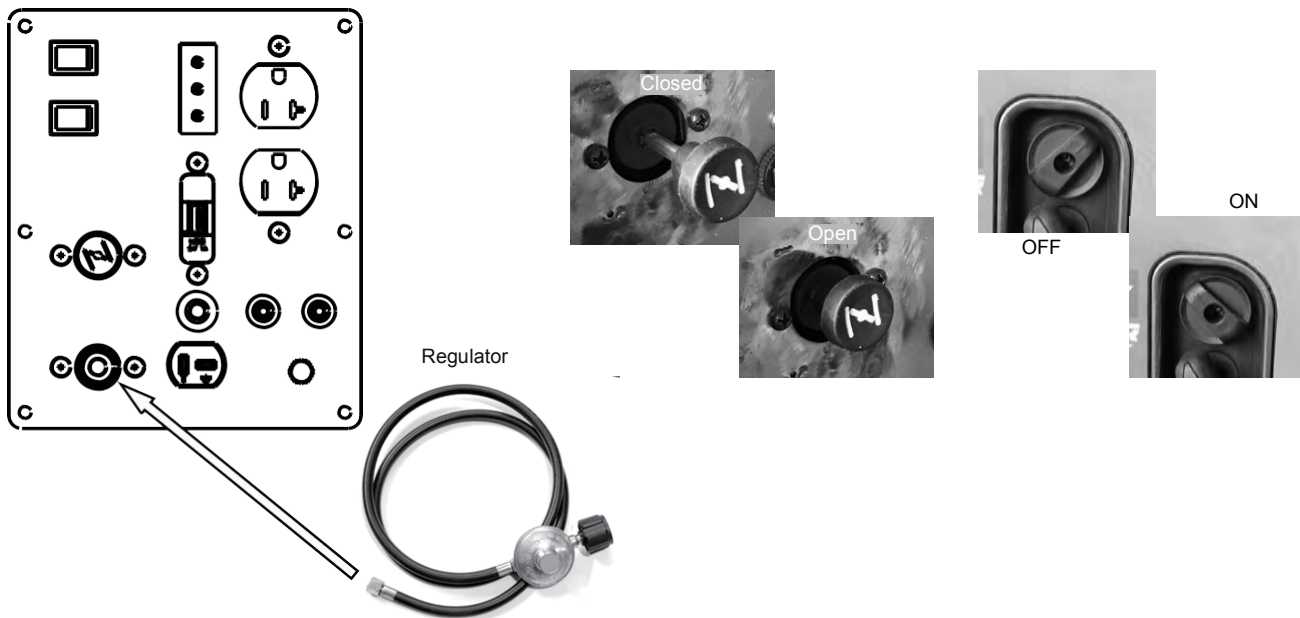

Step 3 - Ground the Generator

WARNING

Failure to properly ground this generator can result in electrocution.

Ground this generator by tightening the grounding nut against a grounding wire as illustrated in Figure 3. A No. 12 AWG (American Wire Gauge) stranded copper wire is generally an acceptable grounding wire. The other end of this grounding wire should be connected to a copper or brass grounding rod that is driven into the earth.

Grounding codes can vary by location. Contact a local electrician for information on grounding regulations for your area.

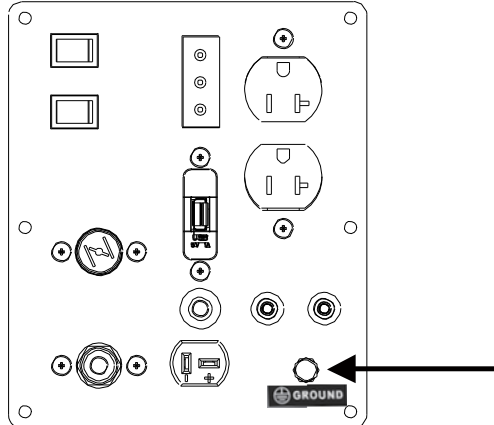

Figure 3 - Attaching the Grounding Wire to this Generator

Subsequent Use of this Generator

For subsequent uses of this generator after the first use, certain steps still must be completed to prepare it for operation.

IMPORTANT: Be familiar with the procedures described in the previous section titled “Using the Generator for the First Time” of this manual. If not, review this section now.

Step 1 - Verify Oil Level

Even though this generator is equipped with an automatic shutoff to protect it from damage due to low oil, it is important to check the oil level in the engine crankcase before each use to ensure that there is sufficient quantity.

1. Verify that this generator is on a level surface.
2. Unscrew the oil filler/dipstick cap from the engine.
3. With a dry cloth, wipe the oil off of the dipstick that is located on the inside of the cap.
4. Fully insert the dipstick without screwing the filler/dipstick cap and then remove again. There should be oil on the dipstick. If there is no oil on the dipstick, or oil is visible only at the very end of the dipstick, add oil until the engine crankcase is filled. (See “Changing/Adding Oil” in the “Maintenance/Care” section of this manual).
5. Confirm that the oil filler/dipstick cap is properly screwed in place when finished verifying the oil level.

Model GEN220DFI Oil Capacity	12 ounces
Model GEN220DFI Oil Type Recommended	High Detergent Motor Oil, SAE10W-30

Step 3 - Ground the Generator

WARNING

Failure to properly ground this generator can result in electrocution.

Ground this generator by tightening the grounding nut against a grounding wire as previously illustrated in Figure 3. A generally acceptable grounding wire is a No. 12 AWG (American Wire Gauge) stranded copper wire. The other end of this grounding wire should be connected to a copper or brass grounding rod that is driven into the earth. Grounding codes can vary by location. Contact a local electrician for information on grounding regulations for your area.

STARTING THE GENERATOR

STOP!

Before starting this generator, confirm that all the steps in the section titled, "Preparing the Generator for Use," of this manual have been correctly completed. If unsure about how to perform any of these steps, call 1-866-460-9436, Monday - Friday, 8 AM - 4 PM Central Time for customer service.

CAUTION

Disconnect all electrical loads from this generator before attempting to start.

- Step 1 If using Propane LPG fuel, open fuel supply on the LP tank.
If using gasoline, make sure unleaded gasoline fuel has been added to the tank.
- Step 2 Turn ENGINE SWITCH at ON position.
- Step 3 Move Choke Lever to CHOKE position.
- Step 4 For recoil start: Pull the STARTER GRIP slowly until resistance is felt and then pull rapidly. After the engine started, return the STARTER GRIP gently to prevent damage to the starter or housing. DO NOT allow the starter grip to snap back. Return it slowly by hand.
- Step 5 Turn the CHOKE LEVER to RUN position.

Choke Rod

The choke is used to provide an enriched fuel mixture when starting a cold engine. It can be opened and closed by operating the choke rod manually. Pull the rod out toward CLOSED to enrich the mixture for cold starting

USING THE GENERATOR

After the engine has been running for several minutes, electrical devices may be connected to this generator.

AC Usage

Electrical devices running on AC current may be connected according to their wattage requirements. The rated (running) and surge wattage:

Model GEN2200DFI Rated (Running) Wattage	1800
Model GEN2200DFI Surge Wattage	2200

The *rated (running) wattage* corresponds to the maximum wattage a generator can output on a continuous basis.

The *surge wattage* corresponds to the maximum amount of power a generator can output for a short time. Many electrical devices, such as a refrigerator, require short bursts of extra power for starting and stopping fan motors, etc., in addition to their listed rated wattage. Motorized devices typically require more than their rated wattage for startup. The surge wattage ability of a generator allows for this extra power requirement.

The total running wattage requirement of the electrical devices connected to a generator should not exceed the rated wattage of the generator itself. To calculate the total wattage requirement of the electrical devices to be connected, look up the rated (running) wattage of each device and add these numbers together to find the total wattage that all of the devices together will draw from the generator. If the total wattage of the selected devices exceeds the rated wattage of the generator, DO NOT connect all of the devices. Select a combination of the electrical devices that will have a total wattage less than or equal to the rated wattage for the generator, i.e., no more than 1800 watts for this generator.

⚠ CAUTION

This generator can run at its surge wattage capacity for only a short time. Connect electrical devices requiring a rated (running) wattage equal to or less than the rated wattage of this generator. Never connect devices requiring a rated wattage equal to the surge wattage of a generator.

A device's rated (running) wattage should be listed somewhere on the device itself and/or in its manual. If the wattage specification for a device is not available, the wattage can be calculated by multiplying the Voltage requirement (120 or 240) by the Amperage drawn.

Watts = Volts x Amperes

Or, the wattage required by a device can be estimated by using the following chart (see Figure 7). The chart provides only estimates and it is better to know the exact wattage of each electrical device to be powered by this generator.

Electrical Device	Rated (Running) Watts	Additional Surge Watts
air compressor (1 HP)	1500	3000
air compressor (1 - 1/2 HP)	2500	2500
airless sprayer (1/3 HP)	600	1200
box fan	300	600
clock radio AM/FM	300	0
coffee maker	1500	0
computer w/17 inch monitor	800	0
deep freezer	500	500
electric drill (1/2 HP)	1000	1000
DVD/CD player or VCR	100	0
furnace fan blower (1/2 HP)	800	1300
garage door opener (1/2 HP)	480	520
hot plate	2500	0
light bulb (75 watt)	75	0
microwave oven (1000 watt)	1000	0
quartz halogen work light	1000	0
refrigerator/freezer (18 Cu. Ft.)	800	1600
saw - circular (7 1/4 inch)	1500	1500
saw - miter (10 inch)	1800	1800
saw - reciprocating	960	1040
security system	180	0
electric stove - single element	1500	0
sump pump	800	1200
television (27 inch color)	500	0
electric water heater (40 gallon)	4000	0
window air conditioner (10000 BTU)	1200	1800
window fan	300	600

Figure 7 - Estimated wattage requirements for common electrical devices.

Connect electrical devices to this generator according to the following procedure:

1. Allow the engine to run for several minutes after it has been started.
2. Confirm that the electrical device is switched off prior to plugging it into this generator.

CAUTION

Connect only electrical devices that are in good working order. Faulty devices or power cords present the risk of electrical shock. Immediately turn off and disconnect any device that commences to operate abnormally, sluggish or abruptly stops. Determine if the problem was the device or the rated load capacity of this generator has been exceeded.

NOTE: While this generator is running, power is available from either the standard 120 Volt outlets or the 12 Volt DC outlet. Both 120 Volts and 12V can be simultaneously drawn from this generator.

3. Turn on the connected electrical devices beginning with the device with the highest rated wattage requirement and then each additional device with the next lower rated wattage requirement.

CAUTION

Do not connect 50Hz or 3-phase loads to this generator.

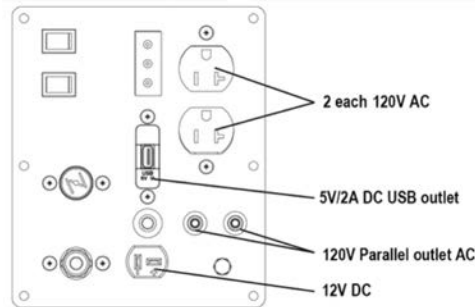

Figure 8 - Outlets available on this generator

SOME NOTES ABOUT POWER CORDS

Long or thin cords can require more wattage from a generator to power an electrical device. Figure 9 shows the recommended cords according to the power requirement of the electrical device. When using cords that exceed these specifications, allow for the electrical device to have a slightly higher rated wattage requirement.

Device Requirements			Max. Cord Length (ft) by Wire Gauge				
Amps	Watts (120V)	Watts (240V)	#8 wire	#10 wire	#12 wire	#14 wire	#16 wire
2.5	300	600	NR	1000	600	375	250
5	600	1200	NR	500	300	200	125
7.5	900	1800	NR	350	200	125	100
10	1200	2400	NR	250	150	100	50
15	1800	3600	NR	150	100	65	NR
20	2400	4800	175	125	75	50	NR
25	3000	6000	150	100	60	NR	NR
30	3600	7200	125	65	NR	NR	NR
40	4800	9600	90	NR	NR	NR	NR

NR = Not Recommended.

Figure 9 - Maximum Extension Cord Lengths by Power Requirement

ECONOMY SWITCH

The Economy Switch automatically reduces engine speed when loads are turned off or disconnected. When appliances are turned on or reconnected, the engine returns to the proper speed to power the electrical load. If high electrical loads are connected simultaneously, turn the Economy switch to the OFF position to reduce voltage changes.

ECONOMY ON: Recommended to minimize fuel consumption and further reduce noise levels when less than a full load is applied to the generator.

ECONOMY OFF: The Economy function will not operate. When using the DC output, turn the Economy Switch to the OFF position. Make sure the Economy Switch is in the OFF position before starting. Turn the Economy Switch to the ON position after the engine has warmed up for 2 or 3 minutes

AC PARALLEL TERMINALS

The parallel port terminals are used with a parallel kit (sold separately). It will allow two generators to be linked to increase output. The black and white wire connections are non-polarized and can be inserted into either the left or right ports.

NOTE: Do not disconnect cables while the generator is running. The generator or the load may be damaged.

NOTE: Only connect two identical Inverter Generators together using a Parallel Kit.

⚠ WARNING

Do not pair more than 2 generators.

Only use the BUFFALO parallel output cable for parallel operation (sold separately).

⚠ CAUTION

You can use the outlets on the control panel of the generator while operating in parallel. Do not exceed combined load on all outlets 26 amps running or 33 amps surge.

⚠ WARNING

If parallel cables are not properly connected to the generators, either or both generators can be damaged and could explode.

⚠ CAUTION

DO NOT connect or disconnect the parallel connection cable from the control panel while the generators are running. Turn off both generators before disconnecting parallel cables.

Before connecting an appliance to a generator, make sure that the appliance is in good working order and that its electrical rating does not exceed that of the outlet. Most appliances require more than their electrical rating for startup.

1. Have both generators ready to operate.
2. Plug in BOTH parallel cables FIRST. If you attach black wire on left and white wire on right, duplicate the same position on the opposite generator.
3. Attach both ground connections on both control panels.
4. Power up each generator, with the Economy Switch in off position.
5. After running a few minutes, plug in appliances into RV cable or outlet on control panel. Make sure appliances are off.
6. Gradually turn on each appliance after making sure both generators are in normal running (the output indicator LED (green) flashes).

Note: The required power of the electrical appliance connected to the parallel outlet cannot exceed the rated output of paralleled generators. See specifications page in owner's manual.

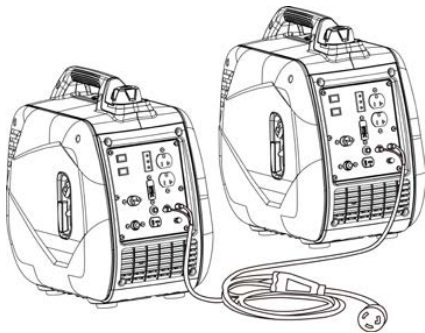

Turning Off Generators while in Parallel Function

1. Disconnect or turn off item plugged into parallel receptacle.
2. Turn off both generators.
3. Carefully disconnect the parallel cables from both generators

DC Usage

CAUTION

The DC outlet is only for recharging 12 Volt automotive-type batteries. Do not connect any other device to this outlet.

CAUTION

Use this generator only for recharging 12 Volt batteries. NEVER attempt to jumpstart a car with this generator.

DANGER

Failing to use the correct procedure can cause a battery to explode, seriously injuring anyone nearby. Keep heat, sparks, flame and smoking materials away from the battery.

To connect 12 Volt batteries to the DC outlet:

1. Connect the red charging wire to the positive terminal of the battery and the black charging wire to the negative terminal of the battery.
2. Connect the plug end of the wire to the 12V DC outlet on this generator.
3. Start this generator.
4. When disconnecting, always disconnect the wires from this generator first to avoid a spark.

DANGER

Storage batteries emit highly explosive hydrogen gas when charged.

Batteries also contain acid, which can cause severe chemical burns.

- Do not allow open flames or cigarettes nearby for several minutes after charging a battery.
- Always wear protective goggles and rubber gloves when charging a battery.
 - If battery acid gets on the skin, flush with water.
 - If battery acid gets in the eyes, flush with water and immediately call a physician.
 - If battery acid is swallowed, drink large quantities of milk and immediately call a physician.

STOPPING THE GENERATOR

To stop this generator:

1. Turn off all connected electrical devices and then unplug them.
2. Allow this generator to run for several more minutes with no electrical devices connected to help stabilize the temperature of this generator.
3. Turn off the engine switch.
4. If using Propane, turn the propane tank fuel valve to the "off" position.

WARNING

Allow this generator to cool down before touching areas that become hot during operation.

MAINTENANCE/CARE

Proper routine maintenance of this generator is essential for safe, economical, and trouble-free operation. It will help prolong the life of this generator as well as help reduce air pollution. Perform maintenance checks and procedures according to the schedule in Figure 10.

STOP!

If you have questions about maintenance procedures described in this manual, call 1-866-460-9436, Monday - Friday, 8 AM - 4 PM Central Time.

⚠ CAUTION

Never perform maintenance procedures while this generator is running. Allow this generator to cool before commencing any maintenance procedures. Keep heat, sparks and flame away.

⚠ WARNING

Improper maintenance and/or failure to correct any problems prior to operating this generator can cause a malfunction which could cause death or serious injury. Always follow the inspection and maintenance recommendations and schedules in this manual.

Recommended Maintenance Schedule

		Each Use	Every Month or Each 20 Hrs	Every 3 Months or Each 50 Hrs	Every 6 Months or Each 100 Hrs	Every Year or Each 300 Hrs
Engine Oil	Check Level	X				
	Replace		X (First Use)		X	
Air Filter	Check					
	Clean			X		X
Fuel Filler	Clean				X	
Spark Plug	Check/Clean			X		
	Clean					X
Spark Arrestor	Clean				X	
Valve Cleanace	Check/adjust					X

Figure 10 - Recommended maintenance schedule

Cleaning the Generator

Always try to use this generator in a cool dry place. If this generator becomes dirty, the exterior can be cleaned with a damp cloth, soft brush, vacuum and/or pressurized air.

Never clean this generator with a bucket of water and/or a hose as water can get inside and cause a short circuit or corrosion.

Never use gasoline to clean parts of this generator.

Checking the Oil Level

Even though this generator is equipped with an automatic shutoff to protect it from damage due to low oil, it is important to check the oil level in the engine crankcase before each use to ensure that there is a sufficient quantity.

To check the oil level:

1. Verify that this generator is shut down and on a level surface.
2. Unscrew the oil filler/dipstick cap from the engine as illustrated in Figure 11.
3. With a dry cloth, wipe the oil off of the dipstick that is located on the inside of the cap.
4. Insert the dipstick as if replacing the cap and then remove again. There should be oil on the dipstick. If there is no oil on the dipstick, or oil is visible only at the very end of the dipstick, add oil until the engine crankcase is filled (see "Changing/Adding Oil" in this section of this manual).
5. Confirm that the oil filler/dipstick cap is properly in place when finished verifying the oil level.

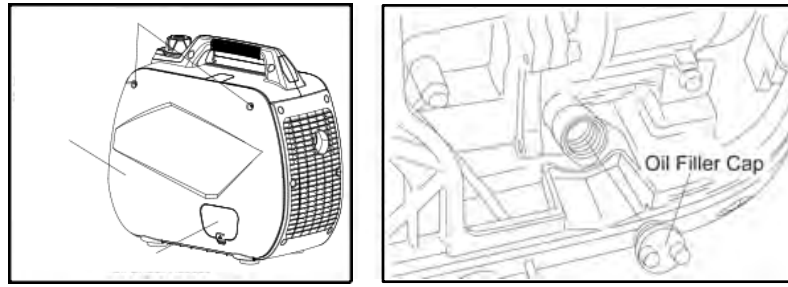

Figure 11 - Checking the Oil

Changing/Adding Oil

The oil level in this generator should be checked before each use. When the oil level is low, add oil until the level is sufficient to operate this generator.

To drain the oil from this generator:

The oil should be changed after the first 20 hours of operation. The oil should then be changed every 6 months, or for every 100 hours of use time, or when it has become contaminated with water and/or dirt.

Drain the oil while the engine is still warm to assure rapid and complete draining.

1. Loosen the cover screw and remove the maintenance cover. (Fig 11A)
2. Remove the oil filler cap (Fig 11B).
3. Drain dirty oil into a container.
4. Refill with the recommended oil, and check the oil level.
5. Reinstall the maintenance cover and tighten the cover screw securely.
6. Engine oil capacity : 12 ounces
7. Wash your hands with soap and water after handling used oil.

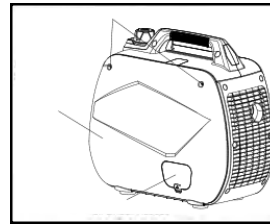

(Fig 11A)

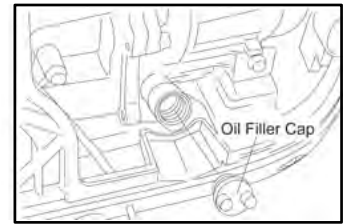

(Fig 11B)

NOTE: Never dispose of used motor oil in the trash, down a drain or on the ground. Put oil in a sealed container and contact your local recycling center or auto garage to arrange oil disposal.

To add oil to the engine crankcase:

1. Confirm that this generator is on a level surface.
2. Unscrew the oil filler/dipstick cap from the engine as illustrated in Figure 11 above.
3. Using a funnel, add high detergent motor oil to fill the engine crankcase to the correct quantity. SAE10W-30 oil is recommended for general use.

When the engine crankcase is full, the oil level should reach the lower lip of the oil filling opening as shown in Figure 12.

Model GEN2200DFI Oil Capacity	12 ounces
Model GEN2200DFI Oil Type Recommended	High Detergent Motor Oil, SAE10W-30



Figure 12 - Adding Oil

Air Filter Maintenance

A dirty air cleaner will restrict air flow to the carburetor. To prevent carburetor malfunction, service the air cleaner regularly. Service more frequently when operating the generator in extremely dirty areas.



WARNING!

Do not use gasoline or low flash point solvents for cleaning. They are flammable and explosive under certain conditions.



CAUTION:

Never run the generator without the air filter, otherwise rapid engine wear may result.

1. Loosen the cover screws and remove the maintenance cover. (Fig. 14A)
2. Remove the air cleaner cover. (Fig. 14B)
3. Wash the filter in a non-flammable or high flash point solvent and dry it thoroughly.
4. Soak the filter in clean engine oil and squeeze out the excess oil.
5. Reinstall the air filter and the air cleaner cover. Tighten the cover screw securely.
6. Reinstall the maintenance cover and tighten the cover screw securely.

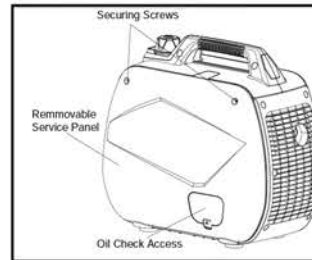

Fig. 14A

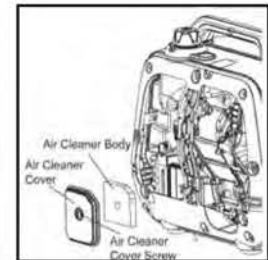
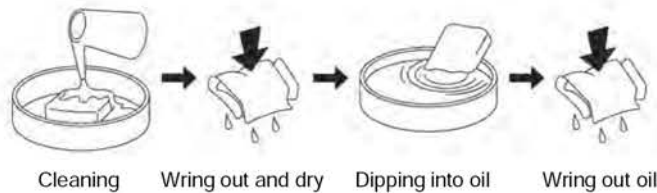

Fig. 14B



Spark Plug Service

- RECOMMENDED SPARK PLUG: NGK CR7HSA
 - To ensure proper engine operation, the spark plug must be properly gapped and free of deposits.
1. Loosen the cover screws and remove the maintenance cover. (Fig.15A)
 2. Remove the spark plug cap. (Fig. 15B)
 3. Clean any dirt from around the spark plug base.
 4. Use the wrench to remove the spark plug. (Fig. 15C).
 5. Visually inspect the spark plug. Discard it if the insulator is cracked or chipped. Clean the spark plug with a wire brush if it is to be reused.
 6. Measure the plug gap with a feeler gauge. The gap should be 0.60-0.70mm (0.024-0.028"). Correct as necessary by carefully bending the side electrode. (Fig. 15 D)
 7. Install the spark plug carefully, by hand, to avoid cross-threading.
 8. After a new spark plug has been seated by hand, it should be tightened 1/2 turn with a wrench to compress its washer.
 9. If a used plug is being reinstalled, it should only require 1/8 to 1/4 turn after being seated.
 10. Reinstall the spark plug cap on the spark plug securely.



CAUTION:

Make sure engine is cool before servicing or removing spark plug.

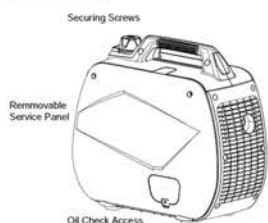

Fig. 15A



Fig 15B



Fig 15B

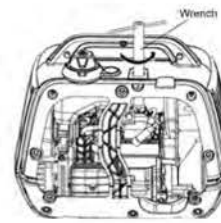

Fig 15C

0.60-0.70mm
(0.024-0.028 In)



Fig 15D

Spark Arrestor

1. Allow the engine to cool completely before servicing the spark arrester.
2. Remove the three screws holding the cover plate which retains the end of the spark arrester to the muffler.
3. Remove the spark arrester screen.
4. Carefully remove the carbon deposits from the spark arrester screen with a wire brush.
5. Replace the spark arrester if it is damaged.
6. Position the spark arrester in the muffler and attach with the three screws.

Changing Fuel Line

Fuel line installation instruction (include the carburetor and the fuel tank ,etc.) :

1. Connect clamp to the fuel hose;
2. Slide fuel hose onto connection until it touches the bottom;
3. Then secure with clamp.

Fuel tank usage and maintenance instructions

1. Please pay attention to the cleanliness of the fuel tank inside when you add the fuel into the fuel tank at the first time, and use a small amount of diesel oil (kerosene) to flush fuel tank inside, after flushed fuel tank inside, and then start filling the fuel.
2. Please pay attention to the sundries will be went into the fuel tank inside when you are filling the fuel; and the fuel quality will affect the performance and safety of the equipment.
3. Please note that the tank should be kept at least a certain amount of space for the expansion of fuel. The rated capacity should be controlled in the fuel tank of the maximum liquid capacity of 95%.
4. Fuel tank pipeline must not use the materials which can cause pipeline blockage due to dissolution.
5. The fuel tank should be regularly discharged residues; After discharging residues, the fuel tank can be used again.
6. Please pay attention to fire safety when you are using the fuel tank.
7. The fuel tank should avoid exposure, and should be placed far away from the fire source, no smoking in the vicinity of the fuel tank, no spark or flame, volatile fuel will cause an explosion.
8. The fuel tank should be regularly checked if the rubber sealing has being aged or not, if you find the components are damaged, please immediately stop using, and replace it.

Storage/Transport Procedures

To prevent fuel spill when transporting or during temporary storage, the generator should be secured upright in its normal operating position, with the engine switch OFF.

1. Be sure the storage area is free of excessive humidity and dust.
 - a. Keep heat, sparks, and flame away.
 - b. Handle fuel only outdoors.
 - c. Wipe up spills immediately.
 - d. Keep out of reach of children and pets.
2. Drain the fuel.
 - a. Drain all gasoline from the fuel tank into an approved gasoline container.
 - b. Loosen the screw of the service panel and remove the service panel, loosen the carburetor bolt and drain the gasoline to a suitable container by the fuel drain pipe.
 - c. When all the fuel is drained, turn the petcock to the OFF position, and tighten the drain screw securely.
3. Clear the engine oil.
4. Remove the spark plug and pour about a table- spoon of clean engine oil into the cylinder. Crank the engine several revolutions to distribute the oil, the reinstall the spark plug.
5. Reinstall the spark plug cap on the spark plug securely.
6. Reinstall the spark plug Access.
7. Reinstall the maintenance cover and tighten the cover screw securely.
8. Pull the starter grip slowly until resistance is felt, then return the starter grip gently. This closes the valves so moisture cannot enter.

Troubleshooting

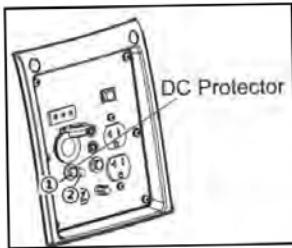

Generator won't produce power

- Safety device (DC protector) to "OFF" ②
Press the DC protector to "ON" ①.
- Safety device (AC) to "OFF"
AC protected automatically by inverter
- Stop the Engine ,then restart..



WARNING!

Be sure that is no spilled fuel around the spark plug.
Spilled fuel may ignite.

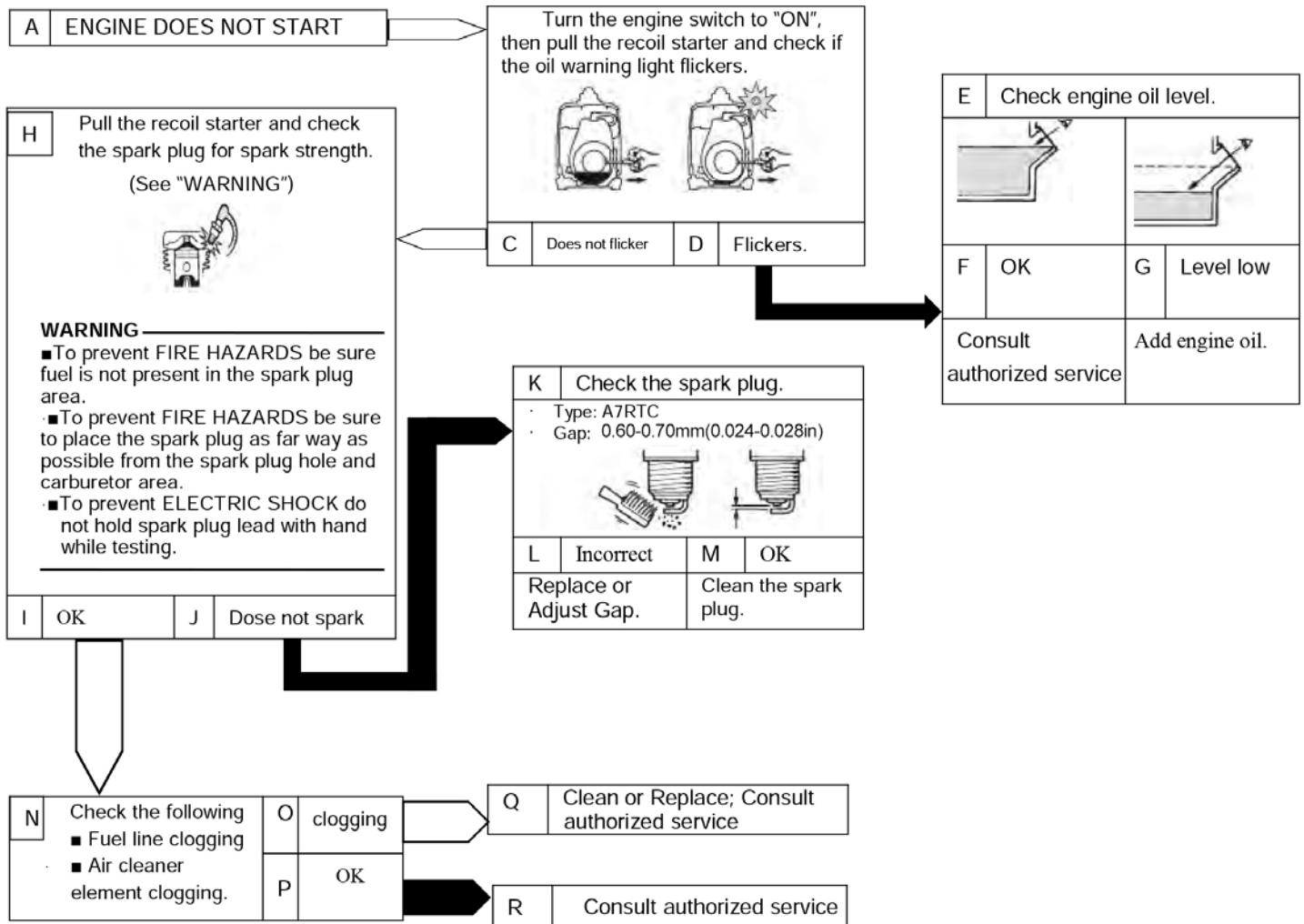

SPECIFICATIONS

GEN2200DFI 2200 Surge Watt / 1800 Running Watt Portable Dual Fuel LPG Liquid Propane Gas & Gasoline Invertor Generator

Generator

Type	Revolving Magnetic Field, Self Exciting, Multi-Pole, Single Phase
------	---

AC Output

Rated Wattage (W)	1800
Surge Wattage (W)	2200
Rated Voltage (V)	120
Rated Amperage	15
Rated Frequency (Hz)	60
Phase	Single

DC Output

Voltage (V)	12
Circuit Breaker Amperage (A)	8

Engine

Engine Type	4-stroke single cylinder with forced air cooling system.
Engine Displacement	79.7cc
Engine Model (HP)	3.0
Compression Ratio	9:1
Ignition System	CDI
Starting System	Recoil
Bore* Stroke (mm)	48.6x43.0
Continuous Operating Hours	Run time = 7 hrs @ 50% load Gasoline fuel
Continuous Operating Hours	Run time = 18 hrs @ 50% load per 20 lbs of LPG fuel
Oil Capacity (SAE10W-30)	12 ounces

PARTS DIAGRAM

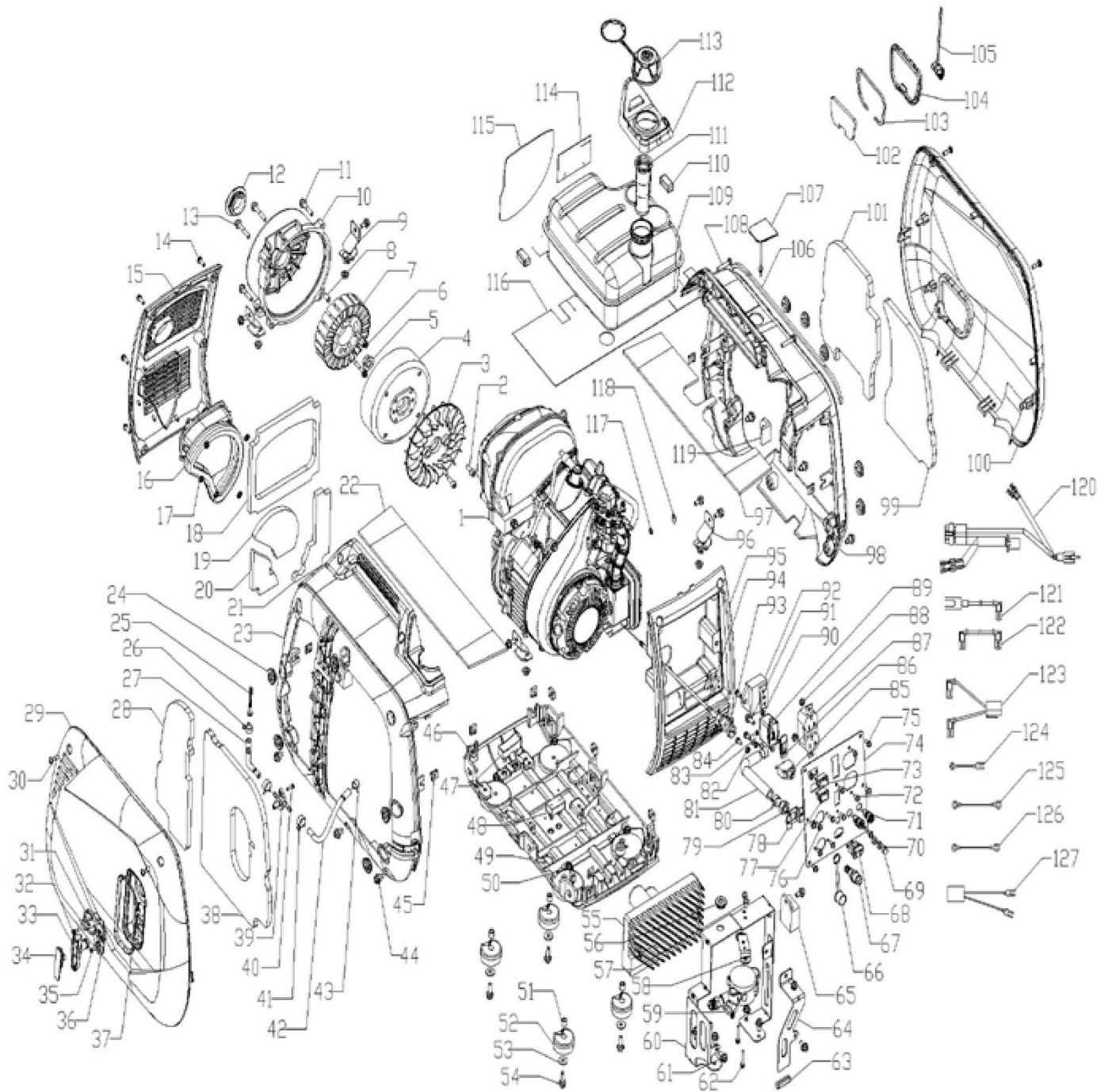

#	Part Number	Description	QTY.	#	Part Number	Description	QTY
1	101200080001000	Engine	1	58	20010422005120	Valve Fixing Plate	1
2	B02210601627	Cross Recess Head Screw	2	59	2704012008000	Pressure Reducing Valve	1
3	32100422003800	Fan	1	60	21060422005800	Inverter Mounting Bracket Assembly	1
4	22070422003000	Alternator	1	61	B01310601267	Flange Nuts	13
5	34010114001000	Hexagon Flange Nut	1	62	B02270403027	Cross Recess Head Screw	2
6	B02040503565	Inner Hexagon Screw	2	63	31130422003800	Rubber Grommets Mounting Bracket	1
7	22050422003000	Stator	1	64	31120422003800	Inverter Mounting Bracket, Fuel	1
8	31140127002000	Pin	2	65	23250421200000	Voltage regulator	1
9	22030422003800	Shock Absorbing Foot	2	66	3X210457501000	Gas Inlet Cap	1
10	32070422003000	End Cover	1	67	3X190457501000	Gas Inlet Connector	1
11	B01310603065	Increased Flange Bolt	3	68	22060411500000	T Type Socket	1
12	32080422003000	Plug, end cover	1	69	B04190600044	Cap Nut	1
13	B01310603566	Increased Flange Bolt	2	70	B04010600048	Hex Nut	2
14	B13080501627	Screw	13	71	20110421202000	Parallel Connection Socket	2
15	34120422003800	Rear Exhaust Cover	1	72	B02210401227	Cross Recess Head Screw	6
16	34130422003800	Rubber Duct	1	73	22030410900000	Engine Switch	1
17	30010222511060	Retainer Ring	5	74	25020452005800	Panel Assy	1
18	34140422003000	Insulating Foam, Exhaust Port	1	75	B02210501227	Cross Recess Head Screw	4
19	34170422003000	Insulating Foam, Duct	1	76	B13080400827	Screw	2
20	34150422003000	Insulating Foam, Left Inlet	1	77	25050422003000	Smart Switch	1
21	34160422003000	Insulating Foam, Right Inlet	1	78	35020452005120	Air Hose Fitting Mounting Bracket	1
22	34050422005000	Insulating Foam, Left top seal	1	79	3X200457501000	Fixing Nut	1
23	24030422005000	Left Body Cover	1	80	3X230457501000	Stainless Clamp	2
24	34040422003800	Rubber Grommet	10	81	3X220457501000	Fuel Gas Hose	1
25	20140421200000	Fuel Filter	1	82	B07180005056	Lock Washer Φ5	2
26	31210421202000	Clamp	1	83	32060421202000	Grounding Piece φ5	1
27	33100422003800	Oil Pipe	1	84	B13080500827	Screw	2
28	34200422003000	Left Foam Seal II	1	85	B28421080010	Circuit Breaker	1
29	34180422005750	Left Body Cover	1	86	35270422003001	USB Rubber Holder	1
30	30230421202000	Screw M6*17	4	87	22070413200000	120V Socket	1
31	34220422003800	Fuel Petcock Knob	1	88	B04280400047	Flang Nut	2
32	30040422001670	Screw M4*11	1	89	23290422000000	USB Socket	1
33	30160421202000	Pull Start Handle	1	90	B04200400047	Nut	2
34	30170421202000	Pull Start Handle Cover	1	91	B01310601628	Flang Bol	1
35	B05210501607	Truss Head Tapping Screw	1	92	25030422003000	Light Indicator Assembly	1
36	34210422003800	Rope Guide Plate Assembly	1	93	32160422003800	Choke Lever Mounting Plate	1
37	34330422003000	Decorating Ring	1	94	22080422003000	Choke Lever	1
38	34190422003000	Left Foam Seal I	1	95	34110422003800	Front Cover	1
39	20110421200001	Fuel Cock	1	96	22030422003801	Shock Absorbing Foot	2
40	B05210401607	Truss Head Tapping Screw	1	97	34070422005000	Insulating Foam, Right Top Seal	1
41	31190421202000	Clamp	2	98	24050422005000	Right Casing	1
42	33110422003800	Fuel Hose, Carburetor	1	99	34240422003000	Insulating Foam I, Right Body Cover	1
43	31200421202000	Clamp	1	100	34230422005750	Right Body	1
44	31150422003020	Shoulder Screws	6	101	34250422003000	Insulating Foam II, Right Body Cover	1
45	30220421202000	Spring Nut	12	102	34280422003000	Foam II, Oil Fill Cover	1
46	31070422003020	Square Nut	6	103	34290422003000	Foam II, Oil Fill Cover	1
47	31030422003800	Cushion Pad	1	104	34260422003750	Oil Fill Cover	1
48	31040422003800	Bumper Block, Engine	1	105	34270422003800	Tether, Oil Fill Cover	1
49	21020422003000	Body Base Plate	1	106	34320422003000	Foam Strip, Right Body Cover	1
50	B04280600047	Flange Nut	8	107	34100422003800	Spark Plug Access Cover	1
51	31020412600010	Spacer	4	108	B02210602027	Cross Recess Head Screw	2
52	31050422003800	Damping Foot	4	109	23010422005800	Fuel Tank	1
53	B07020006047	Flat Gasket	4	110	33060422003800	Tank Mounting Rubber Cushion	2
54	B01310602067	Flange Nut	4	111	21030421202000	Fuel Filter	1
55	21040422005000	Inverter Assy	1	112	34080422005000	Rubber Mat, fuel filling Port	1
56	31140422003800	Damping Ring, Fuel Tank	1	113	21120421202001	Fuel Tank Cap	1
57	B13080501227	Screw	2	114	33070422003000	Silver Paper I	1

#	Part Number	Description	QTY.
115	33080422003000	Silver Paper II	1
116	33090422003000	Silver Paper III	1
117	B07180006056	Lock Washer Φ 6	2
118	30090422001000	Grounding Piece ϕ 6	1
119	34030422003800	Rubber Pad	2
120	21070422003000	Cable Assy	1
121	35110422005000	Parallel Cable	2
122	35130422003000	Connection Cabel,DC protector	1
123	35120422003000	DC Connecting Cable (American)	1
124	35080422003000	Ground Wire5-5	1
125	35090422003000	Ground Wire5-6	1
126	32090422003000	Ground Wire6-6	1
127	22070421202000	AC Connecting Cable	1

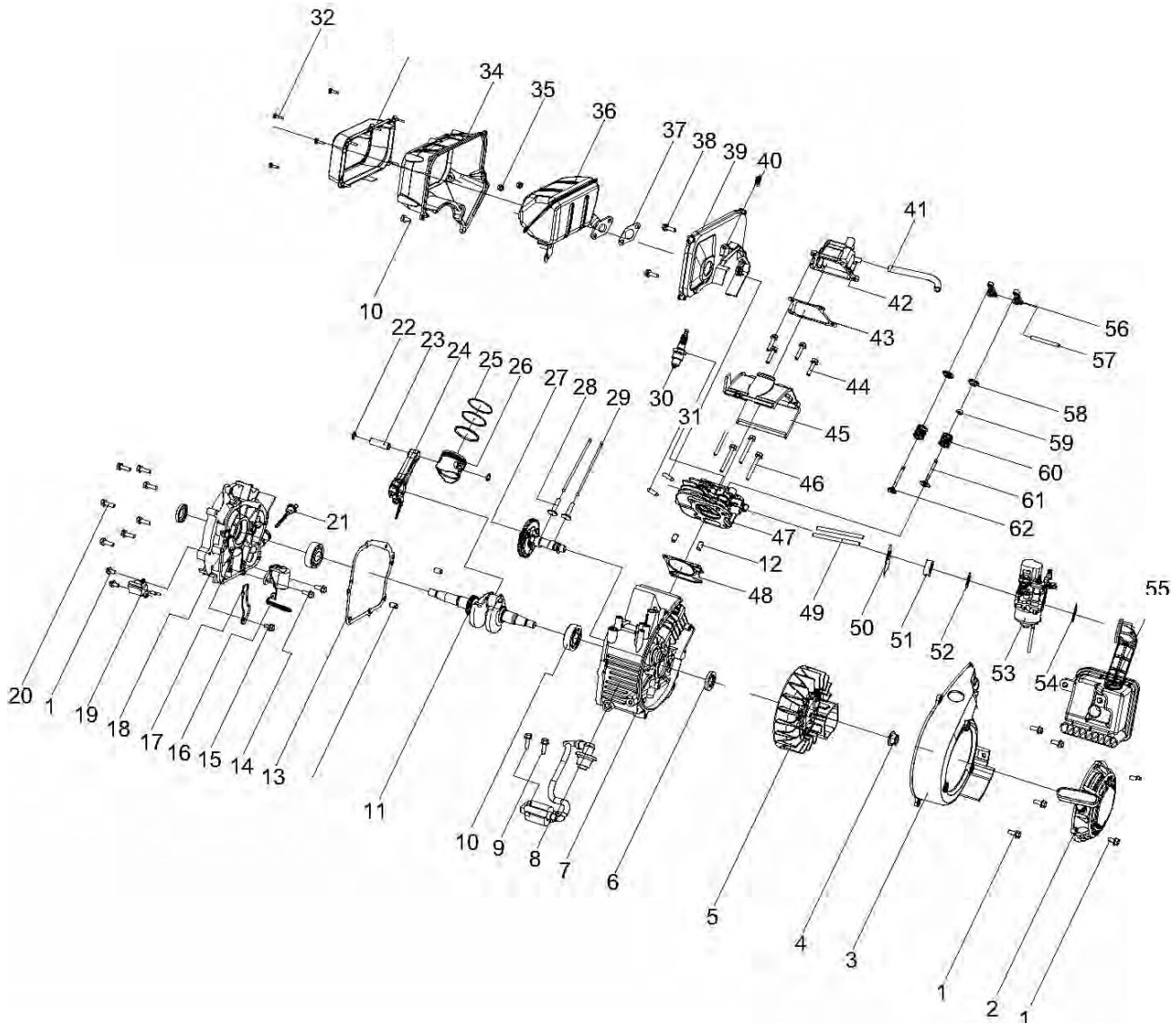

#	Part Number	Description	QTY.
1	B01310601466	Bolt, Flange M6*14	7
2	26040119001000	Stater Assy.	1
3	36070120001000	Case, Fan	1
4	34060119001020	Nut M12	1
5	38030119001000	Rotor Assy.	1
6	B15302035053	Oil Seal Φ 20* Φ 35*5	2
7	31070120001000	Crankcase	1
8	38020119001000	Ignition Coil Assy.	1
9	B01310602066	Bolt, Flange M6*20	2
10	B12016020453	Bearing 6204/P53	2
11	24020120001000	Crankshaft Assy.	1
12	31140127002000	Pin, Dowel	4
13	31020120001000	Gasket, Crankcase Cover	1
14	B01310601666	Bolt, Flange M6*16	2
15	B01310601266	Bolt, Flange M6*12	2
16	31030119001000	Oil Lever Gauge Assy.	1
17	31040120001000	Clamp	1
18	31010120001000	Cover Crankcase	1
19	38010119001000	Coil Assy.	1
20	B01310602066	Bolt, Flange M6*20	9
21	31050120001000	Oil Dipstick Assy.	1
22	34030119001000	Circlip	2
23	34020119001000	Pin, Piston	1
24	24030119001000	Connecting Rod Assy.	1
25	24040119001000	Piston Ring Set	1
26	34010119001000	Piston	1
27	22040119001000	Camshaft Assy.	1
28	32060120001000	Lifter, Valve	2
29	32080120001000	Rod, Valve Push	2
30	31250114001000	Plug, Spark A7RTC	1
31	32120119001000	Bolt, Stud	2
32	B020048016C6	Screw, ST4.8*16	5
33	36030120001000	Duct	1
34	36310119001000	Protector Assy.	1
35	B04280600026	Nut M6	4
36	37010120001000	Muffler	1
37	370101190001000	Gasket of Muffler	1

#	Part Number	Description	QTY.
38	B01310601666	Bolt, Flange M6*16	2
39	36100120001000	Protector Assy.	1
40	36060120001000	Nut Spring	1
41	37060120001000	Pipe, Breather	1
42	32200120001000	Cover, Cylinder Head	1
43	32110120001000	Gasket, Cylinder	1
44	B01310601866	Bolt, Flange M6*18	4
45	36010120001000	Air Shroud, Cylinder 1	1
46	B01310605086	Bolt, Flange M6*50	4
47	22020120001000	Head, Cylinder	1
48	32130119001000	Gasket, Cylinder Head	1
49	32050135001000	Bolt, Stud	2
50	32120120001000	Gasket, Manifold	1
51	32130120001000	Joint	1
52	37020120001000	Gasket, Manifold	1
53	27030120008000	Carburetor Assy.	1
54	37030120001000	Gasket Air Cleaner	1
55	27030120001000	Air Cleaner	1
56	22030120001000	ARM, Valve Rocker	2
57	32030120001000	Shaft, Rocker	1
58	33110114001000	Retainer, Valve Spring	2
59	31010114001000	Seal, Valve Stem	1
60	32050120001000	Spring, Compression	2
61	32010120001000	Valve, Exhaust	1
62	32020120001000	Valve, Intake	1

Wiring Diagram

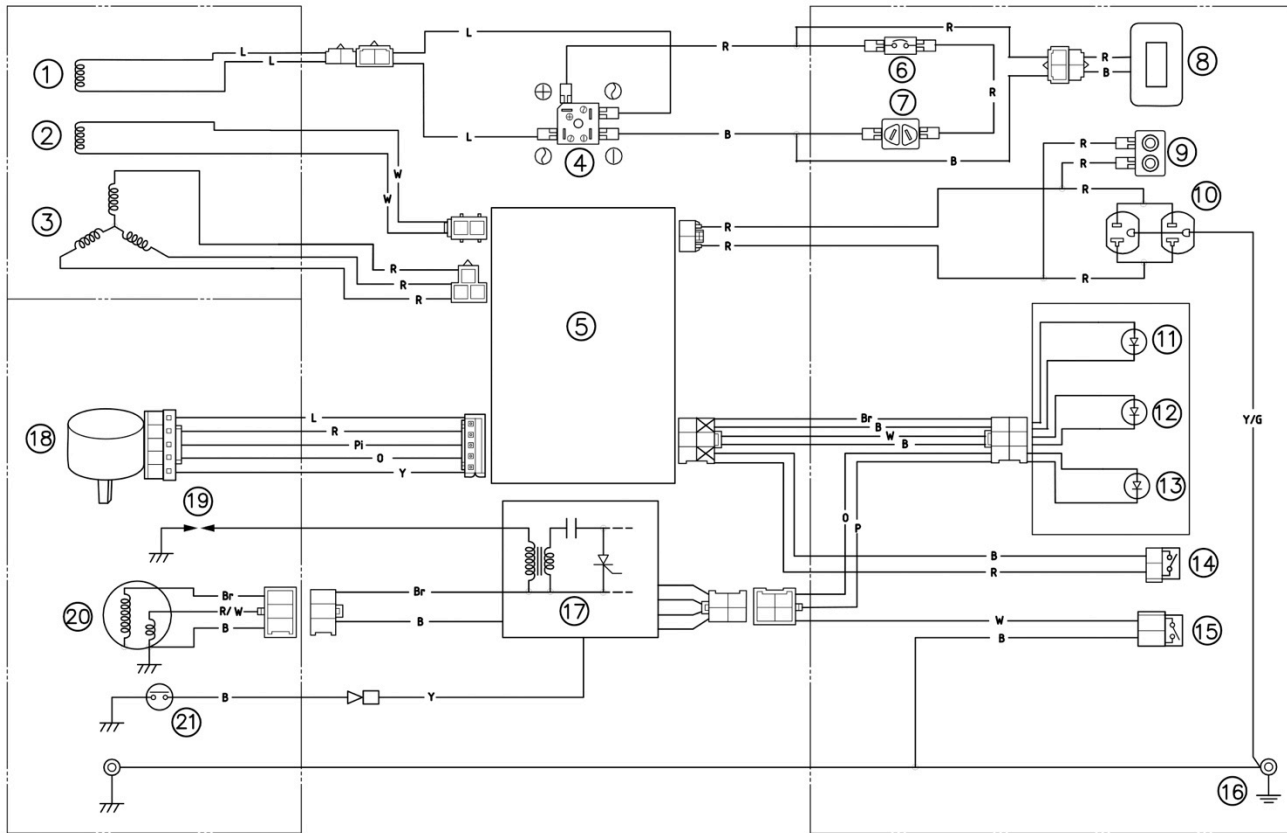

- ① DC WINDING
- ② SUB WINDING
- ③ MAIN WINDING
- ④ RECTIFIER
- ⑤ INVERTER UNIT
- ⑥ CIRCUIT BREAKER (DC)
- ⑦ DC OUTPUT RECEPTACLE
- ⑧ USB OUTPUT RECEPTACLE
- ⑨ TWIN TECH (PARALLEL TERMINAL)
- ⑩ AC OUTPUT RECEPTACLE
- ⑪ OUTPUT INDICATOR
- ⑫ OVERLOAD INDICATOR
- ⑬ OIL ALERT INDICATOR
- ⑭ ECO THROTTLE SWITCH
- ⑮ ENGINE STOP SWITCH
- ⑯ GROUND (Earth) terminal
- ⑰ C. D. I. UNIT
- ⑱ THROTTLE CONTROL MOTOR
- ⑲ SPARK PLUG
- ⑳ C. D. I. MAGNETO
- ㉑ OIL LEVEL SWITCH

Color code

B	Black
Br	Brown
G	Green
L	Blue
O	Orange
P	Purple
Pi	Pink
R	Red
W	White
Y	Yellow
Y/G	Yellow/Green
R/W	Red/White

EMISSION CONTROL SYSTEM WARRANTY

BUFFALO CORPORATION

Your Warranty Rights and Obligations

The California Air Resources Board, U.S. EPA and Buffalo Corp. are pleased to explain the Emission Control System Warranty on your 2017 model year new outdoor power equipment engine.

California

In California, new spark-ignited small off-road equipment engines must be designed, built and equipped to meet the State's stringent anti-smog standards.

Other States, U.S. Territories

In other areas of the United States, your engine must be designed, built and equipped to meet the U.S. EPA emission standards for spark-ignited engines at or below 19 kilowatts.

All of the United States

Buffalo Corp. must warrant the emission control system on your power equipment engine for the periods of time listed below provided there has been no abuse, neglect or improper maintenance of your power equipment engine. Where a warrantable condition exists, Buffalo Corp. will repair your power equipment engine at no cost to you including diagnosis, parts and labor.

Your emissions control system may include parts such as: carburetors or fuel injection system, ignition system, catalytic converters, fuel tanks, valves, filters, clamps, connectors, and other associated components. Also, included may be hoses, belts, connectors, sensors, and other emission-related assemblies.

Manufacturer's Warranty Coverage:

The emission control system is warranted for two years. If any emissions-related part on your engine is defective, the part will be repaired or replaced by Buffalo Corp.

Owner's Warranty Responsibility

As the power equipment engine owner, you are responsible for the performance of the required maintenance listed in your owner's manual. BUFFALO CORP.

recommends that you retain all receipts covering maintenance on your power equipment engine, but BUFFALO CORP. can not deny warranty solely for the lack of receipts or for your failure to ensure the performance of all scheduled maintenance.

As the power equipment engine owner, you should however be aware that BUFFALO CORP. may deny your warranty coverage if your power equipment engine or a part has failed due to abuse, neglect, improper maintenance or unapproved modifications.

You are responsible for presenting your power equipment engine to distribution center or service center authorized by BUFFALO CORP. as soon as the problem exists.

The warranty repairs should be completed in a reasonable amount of time, not to exceed 30 day.

If you have any questions regarding your warranty rights and responsibilities, you should contact Buffalo Corp. customer service representative at 1-866-460-9436 or write to info@bufflotools.com

DEFECTS WARRANTY COVERAGE

Adopted by the Air Resources Board, Buffalo Corp. warrants to the ultimate purchaser and each subsequent purchaser that the small off-road engine (SORE)(1) has been designed, built and equipped so as to conform with all applicable regulations; and (2) is free from defects in materials and workmanship that cause the failure of a warranted part to conform with those regulations as may be applicable to the terms and conditions stated below.

(a) The warranty period begins on the date the engine is delivered to an ultimate purchaser or first placed into service. The warranty period is two years.

(b) Subject to certain conditions and exclusions as stated below, the warranty on emissions related parts is as follows:

(1) Any warranted part that is not scheduled for replacement as required maintenance in your Owner's Manual is warranted for the warranty period stated above. If the part fails during the period of warranty coverage, the part will be repaired or replaced by Buffalo Corp. According to Subsection (4) below. Any such part repaired or replaced under warranty will be warranted for the remainder of the periods.

(2) Any warranted part that is scheduled only for regular inspection in your owner's manual is warranted for the warranty period stated above. Any such part repaired or replaced under warranty will be warranted for the remaining warranty period.

(3) Any warranted part that is scheduled for replacement as required maintenance in your owner's manual is warranted for the period of time before the first scheduled replacement date for that part. If the part fails before the first scheduled replacement, the part will be repaired or replaced by Buffalo Corp. According to Subsection (4) below. Any such part repaired or replaced under warranty will be warranted for the remainder of the period prior to the first scheduled replacement point for the part.

(4) Repair or replacement of any warranted part under the warranty provisions herein must be performed at a warranty station at no charge to the owner.

(5) Notwithstanding the provisions herein, warranty services or repair will be provided at all of our distribution centers that are franchised to service the subject engines.

- (6) The engine owner must not be charged for diagnostic labor that leads to the determination that a warranted part is in fact defective, provided that such diagnostic work is performed at a warranty station.
- (7) Buffalo Corp. is liable for damages to other engine components proximately caused by a failure under warranty of any warranted part.
- (8) Throughout the engine warranty period stated above, Buffalo Corp. will maintain a supply of warranted part sufficient to meet the expected demand for such parts.
- (9) Any replacement may be used in the performance of any warranty maintenance or repairs and must be provided without charge to the owner. Such use will not reduce the warranty obligations of Buffalo Corp.
- (10) Add-on or modified parts that are not exempted by the Air Resources Board may not be used. The use of any non-exempted add-on or modified parts by the ultimate purchaser will be grounds for disallowing a warranty claims. Buffalo Corp. will not be liable to warrant failures of warranted parts caused by the use of a non-exempted add-on or modified part.
- (11) The manufacturer issuing the warranty shall provide any documents that describe that manufacturer's warranty procedures or policies within five working days of request by the Air Resources Board.

EMISSION WARRANTY PARTS LIST

- (1) Fuel Metering System:
 - (a) Gasoline carburetor assembly and its internal components
 - (b) Carburetor gaskets (c) Fuel line
 - (d) Clamps (e) Fuel tank
 - (f) Fuel line fittings (g) Pressure regulator(if equipped)
 - (h) Mixer assembly and its internal components (if equipped)
- (2) Air induction system including:
 - (a) Intake pipe/manifold (b) Air cleaner
- (3) Ignition system including:
 - (a) Spark plug (b) Ignition coil
- (4) Catalytic muffler assembly including:
 - (a) Muffler gasket (b) Exhaust manifold
 - (c) Catalytic converter (if available)
- (5) Crankcase breather assembly including:
 - (a) Breather connection tube
- (6) Fuel tank evaporative emissions control system including:
 - (a) Purge valves (b) Carbon canister
 - (c) Canister mounting brackets (d) Fuel cap
 - (e) Fuel tank
- (7) Miscellaneous items used in above systems including:
 - (a) Switches (b) Hoses, belts connectors and assemblies
- (8) Air injection system
 - (a) Pulse valve

201709