



OUTDOOR STORAGE

MODEL N° 60075

CONSISTS OF MODEL N° 6402
AND EXTENSION KIT MODEL N° 6422

COPY

Keep this Identification Number in case you need to contact our Customer Service Department.



OUTDOOR STORAGE

MODEL N° 6402

OWNER'S MANUAL

COPY

Keep this Identification Number in case you must contact our Customer Service Department.

IMPORTANT! PLEASE READ BEFORE BEGINNING ASSEMBLY

Dear Valued Customer,

We would like to congratulate you on your purchase of a Lifetime® Outdoor Storage Shed! We are confident that you have made the perfect choice and you will be very pleased with your new storage solution.

Lifetime® Outdoor Storage is part of the family of products created and manufactured by Lifetime® Products, Inc. Like all of our products, you can be assured that the quality of your Lifetime Outdoor Storage Shed is the best in the world! And, we back that quality up by offering the best warranty in the business – A 10-year warranty that fully covers the Shed!

All of our Sheds are built with the highest-quality steel and high-density polyethylene (HDPE) parts. The design and construction of our steel-reinforced double-Wall Panels is second to none. All of our exposed steel parts and gables are powder coated and we use high-density polyethylene plastic. What makes polyethylene so special? It has superior strength and durability, and, it won't crack or degrade outdoors.

So now that you know the quality you are getting in a Lifetime Outdoor Storage Shed, please take the time to READ THIS INSTRUCTION MANUAL!

We have taken great care in providing the best possible form of instructions to help you put your new Outdoor Storage Shed together. Before you get started, PLEASE read the following preparation tips to help you get started!

We can assure you, your construction experience will be a lot more enjoyable if you do!

PREPARATION TIPS:

- The first step is simple... RELAX! You have made a great purchase, but Rome was not built in a day. Plan to spend a good part of your weekend putting together your fine Outdoor Storage Shed. Our philosophy is, if it comes together quickly and easily, it surely will come apart quickly and easily! Your Lifetime® Outdoor Storage Shed will surely last a long, long time, if you are patient, and take all the time necessary to put it together as we have instructed.
- Grab a friend to join in on the fun! This is not a one-person endeavor. We have found that not only will things go smoother if you have two or more people participating in the construction of the Shed, but it will go quicker as well. So, the more the merrier!
- Make sure you have all the tools necessary for constructing your new Shed. There is a "Tools Required For This Assembly" list on page five of this Owner's Manual.
- The plastic pieces of your Shed may become damaged by over tightening the screws. To avoid this damage, we strongly recommend the use of a low-powered power screwdriver or a drill that has an adjustable clutch that is set on a low-torque setting. If neither is available, use a hand screwdriver. If a hand screwdriver is all you have, take several breaks... your wrist will need it!
- You will also need two small ladders (when it comes time to do the roof!).

IMPORTANT! PLEASE READ BEFORE BEGINNING ASSEMBLY

- Before beginning assembly, remove the Parts List from the center of this Owner's Manual and take an inventory of the parts included with your Outdoor Storage Shed. Also, read through the entire instruction manual. It's always a great practice to get a feel for the flow of the process and to familiarize yourself with the parts involved. But, try not to get ahead of yourself and start the process out of order.
- FOLLOW THE INSTRUCTIONS IN ORDER! Everything goes together in a certain order, and we have learned what that correct order should be. In our state-of-the-art research and testing facility, we have painstakingly created these instructions. The order of construction is there for a reason, and some parts simply will not fit if built out of order. Just follow along with the order in the instructions and everything will fit together and things will go very smooth.
- YOUR SHED MUST BE BUILT ON A LEVEL SURFACE! If the spot you have chosen to place your wonderful new Outdoor Storage Shed is not level, the Shed will not assemble correctly! We recommend a concrete patio, a wood platform or creating a pad with pea gravel. Your Shed is meant to last a lifetime, so provide the proper foundation for it before you start to build.
- Before you build it, make sure you are allowed to build it! Consult all building codes, as well as city and county ordinances, to ensure that you do not require a building permit to construct your Outdoor Storage Shed. Proper building permit documentation may be required in your neighborhood, and it would be quite unfortunate to learn this after your Outdoor Storage Shed is already built!

Now that you're ready to begin the construction of your wonderful new Outdoor Storage Shed, step back, take a deep breath, get yourself a large cold beverage and enjoy yourself. We guarantee that after spending the right amount of time in building your Shed, you will be able to enjoy it for years to come.

Thanks for choosing Lifetime®, and have fun!

ABOUT LIFETIME PRODUCTS, INC.

Lifetime Products, Inc., has applied innovation and cutting-edge technology in plastics and metals to create a family of affordable lifestyle products that feature superior strength and durability. The world's leading manufacturer of folding tables and chairs, Lifetime was founded in 1986 as the maker of portable basketball systems that revolutionized the industry with patented technology. With diverse offerings such as outdoor storage sheds and steel utility trailers, Lifetime continues to develop innovative products that outfit the way you live.

Lifetime makes the things you need for the lifestyle you want. By innovating products in and around the home, Lifetime simplifies your everyday life and enables you to get the most out of your free time.



REGISTER YOUR LIFETIME PRODUCT TODAY!

There are benefits to registering your Lifetime product. With our new online product registration form, it's fast and easy! Register with us at www.lifetime.com and enjoy these great benefits:

- Receive exclusive money-saving offers from BuyLifetime.com, our online store, as well as NEW product notifications and special closeout promotions!
- In the unlikely event of a product recall or safety modification, we will notify you.
- Registering your product guarantees you warranty service. If you do not register your product, your warranty rights will not be diminished. But you will need to provide a sales receipt to verify your product purchase date before warranty service will be provided.

LIFETIME'S PROMISE TO YOU:

Maintaining your privacy is our long-standing policy at Lifetime. And you can rest assured that Lifetime will not sell or provide your personal data to other third parties, or allow them to use your personal data for their own purposes.

We invite you to read our privacy policy at www.lifetime.com

REGISTER today!

****U.S. and Canada customers ONLY****

IF ASSISTANCE IS NEEDED,

DO NOT CONTACT THE STORE!

CALL OUR CUSTOMER SERVICE DEPARTMENT at 1 (800) 225-3865

HOURS: 7:00 a.m. to 5:00 p.m. Monday through Friday (Mountain Standard Time)

Call, or visit our Web site for Saturday hours

For customers outside the U.S. or Canada, please contact the store for assistance.



SAFETY INSTRUCTIONS



FAILURE TO FOLLOW THESE WARNINGS MAY RESULT IN SERIOUS INJURY OR PROPERTY DAMAGE AND WILL VOID WARRANTY.

To ensure safety, do not attempt to assemble this product without following the instructions carefully. Check entire box and inside all packing material for parts and/or additional instruction material. Before beginning assembly, read the instructions and identify parts using the hardware identifier and parts list in this document. Proper and complete assembly, use and supervision are essential to reduce the risk of accident or injury.

- Do not use or store hot objects such as grills, blowtorches, welding equipment, etc. near the product.
- If using a ladder during assembly, use extreme caution.
- Two capable adults are required for assembly. (It is also recommended that a third adult function as an instruction reader.)

Most injuries are caused by misuse and/or not following instructions. Use caution when using this product.

BEFORE BEGINNING ASSEMBLY



Keep the hardware bags and their contents separate. If any parts are missing, call our Customer Service Department.



Read the “Congratulations” letter on page 2-3. Identify and inventory all parts and hardware using the parts and hardware lists and identifiers in this document.

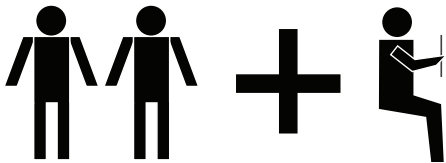

****Two adults required to complete assembly****
(+ one adult suggested as an instruction reader)

Only adults should set up the product. Do not allow children in the set-up area until assembly is complete.



TOOLS REQUIRED FOR THIS ASSEMBLY

7/16"



(2)

3/8"



(1)

Adjustable

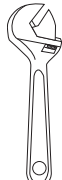

(1)

Rubber Mallet

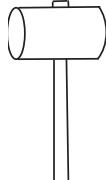

(1)

Box Knife



(1)

Phillips Screwdriver



(1)

Plain Screwdriver



(1)

3/8" Masonry Bit



(1)

2" x 4" x 8' Leveling Board



(1)

6' Ladder



(2)

Power Drill*

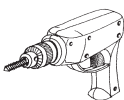

(1)

Work Light

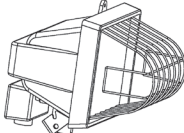

(1)

Pliers



(1)

Flashlight



(1)

Hammer Drill*

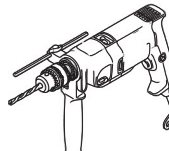

(1)

Safety Glasses



(1 for each person)

*See “Screwdriver Notice” on page 7.

ASSEMBLY GUIDES

Refer to the following areas throughout the instructions to assist in the assembly process:

This area is located at the top, left-hand corner of the page and indicates which tools and hardware are needed to complete the assembly steps on a page.



TOOLS AND HARDWARE REQUIRED FOR THIS PAGE



This area is located at the top, right-hand corner of the page and shows an image of the product with shaded parts indicating which section is being assembled.



This area is usually located in the bottom, left-hand corner of a step and indicates that special attention is needed to perform a particular part of a step.



Note:

These areas are usually located in the bottom, right-hand corner of a step and indicate that damage to the product or serious injury may occur if the caution or warning is not heeded.



CAUTION



WARNING

Throughout the Parts & Hardware List, Part & Hardware Identifiers, and instructions are three-letter IDs. These IDs are below the images of the parts and hardware to help you locate and identify the parts and hardware during assembly. These IDs are not necessarily on the parts themselves.

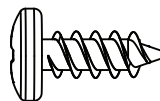

ADZ (x10)
1/4" x 5/8" Pan-Head Screw

IMPORTANT NOTICES

Level Surface Notice:

Surface must be leveled before installation. We recommend building a level work space with a concrete or patio style surface. If the surface is not properly leveled, the Outdoor Shed will not assemble correctly. Proper surface leveling will save you time in the long run, so please do not ignore this step.

Building Code Notice:

Consult all local building codes, as well as city and county ordinances, to ensure that the construction of the Outdoor Shed does not require a building permit. Proper building permit documentation may be required in your neighborhood, and it would be unfortunate to learn this after constructing the Shed.

Screwdriver Notice:

You may use a #2 Phillips head screwdriver bit and a power screwdriver or drill, instead of a hand screwdriver. However, be aware that the plastic pieces of your Shed can be damaged by overtightening of screws. To avoid damage we strongly recommend the use of a low-powered power screwdriver or a drill that has an adjustable clutch that is set on a low torque setting. If neither is available, use a hand screwdriver. In any case use caution to avoid overtightening the screws.

Floor Puncture Notice:

Sharp objects may damage your floor. If resting sharp, heavy objects on your Shed floor, place a block of wood between the sharp object and floor.

CAUTION:

If more than six (6) inches of snow accumulate on the roof of the shed, carefully remove the snow to avoid possible roof collapse. While standing on the ground, remove the snow from the roof with a broom or snow shovel. Do not stand on the roof to remove snow.

PARTS & HARDWARE LIST

BOX 1

SHED PARTS BOX

ID	Description	Qty
AGZ	Right Door	1
AGO	Left Door	1
AGF	Entry Gable	1
AGH	Rear Gable 1	1
AGI	Rear Gable 2	1
AGR	Outer Floor Panel	2
AFX	Center Floor Panel	3
AFV	90" Shelf	1
AFY	Center Roof Cap	4
AGQ	Roof Panel	10
AFS	10" x 30" Shelf	2
AGG	Front Roof Cap	1
AFW	Rear Roof Cap	1

CAQ 6402 SMALL PARTS KIT

AFZ	Corner Shelf	2
AHC	Skylight	5
AFL	Roof Support Strip	10

CAS 6402 METAL KIT 1

AFH	Truss Gutter Channel	8
-----	----------------------	---

CAT 6402 METAL KIT 2

AFG	Roof Truss Brace	4
AFM	Wall/Shelf Support Channel	2
AFC	Door End Channel	2
AFE	Entry Header Bar	1
CRD	Door Hinge Tube	2

BOX 2

SHED PARTS BOX

AGY	Corner Wall Panel 104	1
AGN	Corner Wall Panel 105	1
AGW	Corner Wall Panel 106	1
AGL	Corner Wall Panel 107	1
AHD	Wall Panel	8
AHH	Window Wall Panel	2
AHE	Window	2

CAU 6402 SMALL PARTS BOX

AIX	Wood Shim	4
AIW	Wood Block	1

BHV GABLE ASSEMBLY HARDWARE (x2)

AGP	Louvered Vent	1
AIQ	Vent Screen	1
ADW	#10 x 3/4" Pan-Head Screw	5
AEE	#10 x 1/2" Flat Washer	5
ADZ	1/4" x 5/8" Pan-Head Screw	4
AHS	End Plug	2
ADV	1/4" x 1 1/8" Pan-Head Screw	6
ACB	#10 x 1 1/4" Pan-Head Screw	1

BQH FLOOR ASSEMBLY HARDWARE

BQC	#8 x 1/2" Pan-Head Screw	20
AHO	Door Hinge Bushing	2
ADC	#2 Phillips Bit	1

BEA TRUSS FRAME ASSEMBLY HARDWARE (x4)

ADJ	1/4" Cap Nut	2
ADY	#10 x 3/8" Pan-Head Screw	6
ADK	#10 Cap Nut	6
AIP	Truss Connector	1
ADH	1/4" Threaded Rod	1

ID	Description	Qty
BEB WALL INSTALLATION HARDWARE		
ADZ	1/4" x 5/8" Pan-Head Screw	85
SHELF INSTALLATION HARDWARE		
BHI Corner Shelf Installation Hardware (x2)		
ADZ	1/4" x 5/8" Pan-Head Screw	4
BHH 90" & 30" Shelf Installation Hardware (x3)		
ADZ	1/4" x 5/8" Pan-Head Screw	14
AIY	Shelf Support Bracket	2
BEJ WINDOW INSTALLATION HARDWARE (x2)		
ADZ	1/4" x 5/8" Pan-Head Screw	4
AIS	Window Latch Bracket	2
ADY	#10 x 3/8" Pan-Head Screw	1
BEF LEFT DOOR ASSEMBLY HARDWARE		
AHZ	Left Door Handle	1
AHM	Deadbolt Latch	2
ABU	1/4" x 1 1/2" Carriage Bolt	2
ADW	#10 x 3/4" Pan-Head Screw	3
AEE	#10 x 1/2 Flat Washer	3
ADJ	1/4" Cap Nut	2
AIA	Left Door Lock Bracket	1
AIB	Left Door Strike Plate	1
BEG RIGHT DOOR ASSEMBLY HARDWARE		
AIK	Right Door Handle	1
ABV	1/4" x 2" Carriage Bolt	2
ADB	3/8" x 1/2" Steel Spacer	2
AAB	1/4" Centerlock Nut	2
AHY	Latch Spring	1
AHW	Latch Block	1
AIO	Thumb Lever	1
ADW	#10 x 3/4" Pan-Head Screw	4
AHX	Latch Cover Plate	1
AHV	Latch, Door	1
AIL	Right Door Lock Bracket	1
AEB	1/4" Flat Washer	2
AEE	#10 x 1/2" Flat Washer	5
BHZ DOOR & ENTRY GABLE INSTALLATION HARDWARE		
ADZ	1/4" x 5/8" Pan-Head Screw	6
AHP	Cotter Pin	2
AIC	Left Gap Flap	1
AIM	Right Gap Flap	1
ADX	#10 x 1/2" Pan-Head Screw	4
CAO TRUSS, REAR GABLE, & ROOF INSTALLATION HARDWARE		
ADZ	1/4" x 5/8" Pan-Head Screw	152
AED	#10 x 1" Fender Washer	30
ADX	#10 x 1/2" Pan-Head Screw	30
AXX	Truss Hole Insert	2

PARTS IDENTIFIER

BOX 1

SHED PARTS BOX

Parts shown at 4% of actual size

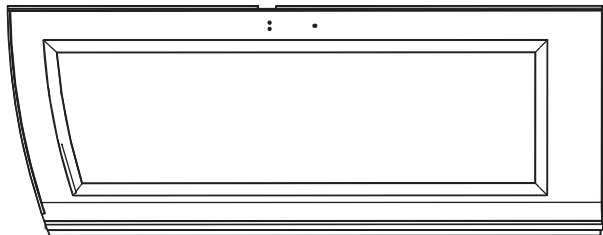

AGO (x1)
Left Door

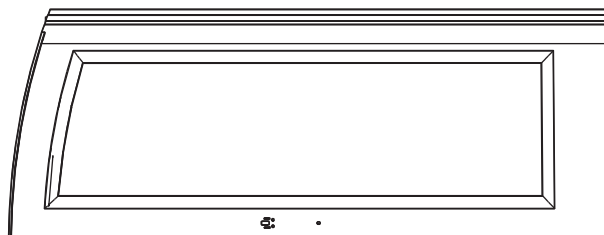

AGZ (x1)
Right Door

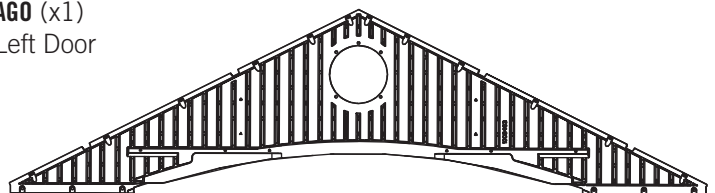

AGF (x1)
Entry Gable

(Rear View)



AGH (x1)
Rear Gable 1

(Rear View)

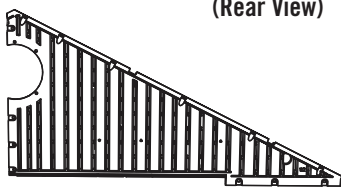

AGI (x1)
Rear Gable 2

(Rear View)

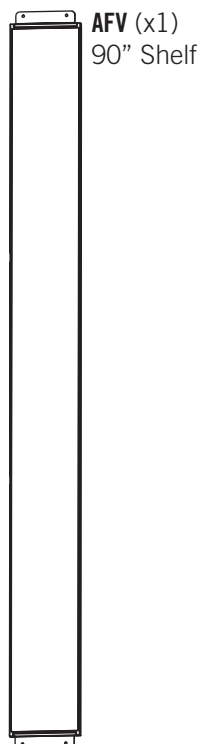

AFV (x1)
90" Shelf

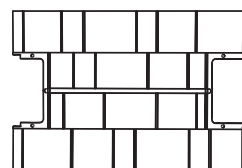

AFY (x4)
Center Roof Cap

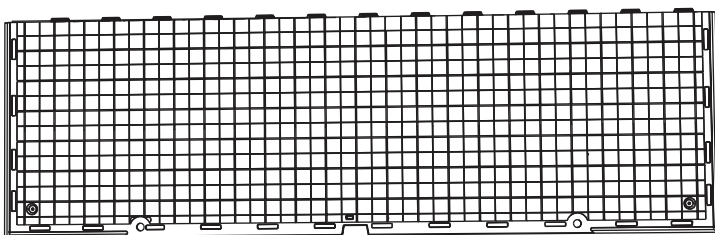

AGR (x2)
Outer Floor Panel

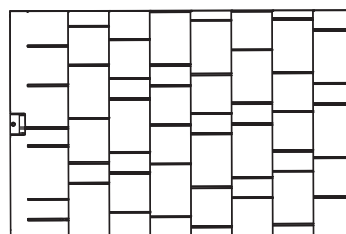

AGQ (x10)
Roof Panel

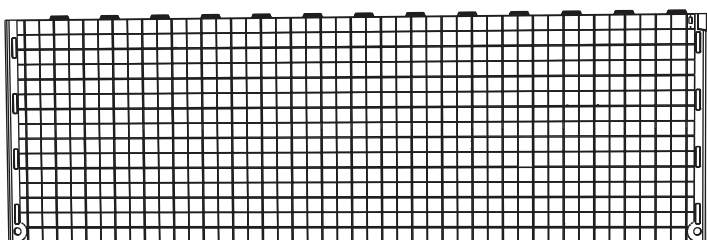

AFX (x3)
Center Floor Panel

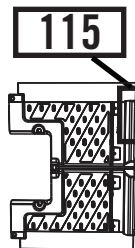

AGG (x1)
Front Roof Cap

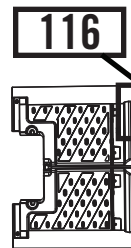

AFW (x1)
Rear Roof Cap



1002314
AFS (x2)
10" x 30" Shelf

! *Note: Throughout the Parts & Hardware List, Part & Hardware Identifiers, and instructions are three-letter IDs. These IDs are below the images of the parts and hardware to help you locate and identify the parts and hardware during assembly. These IDs are not necessarily on the parts themselves.*

PARTS IDENTIFIER

BOX 1

6402 METAL KIT 1 [CAS]

Parts shown at 8% of actual size

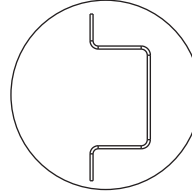
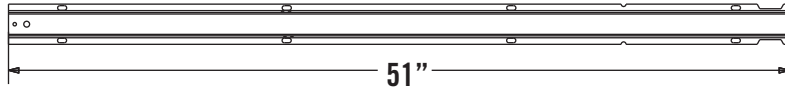

AFH (x8)
Truss Gutter Channel

6402 METAL KIT 2 [CAT]

Parts shown at 8% of actual size

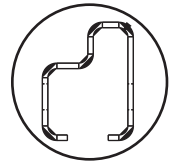
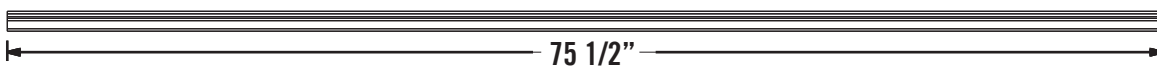

AFC (x2)
Door End Channel

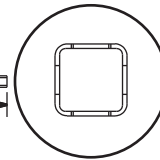
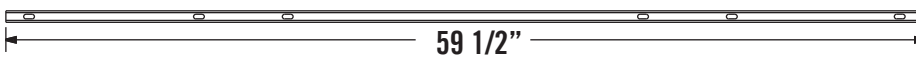

AFE (x1)
Entry Header Bar

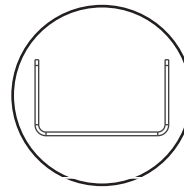

AFG (x4)
Roof Truss Brace

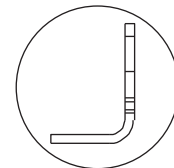
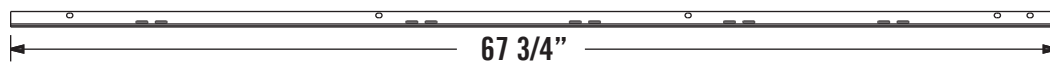

AFM (x2)
Wall/Shelf Support Channel

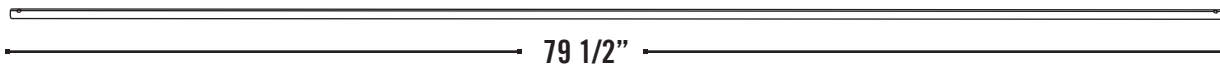

CRD (x2)
Door Hinge Tube

6402 SMALL PARTS KIT [CAQ]

Parts shown at 8% of actual size

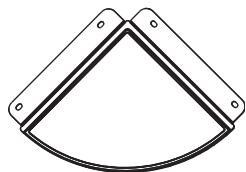

AFZ (x2)
Corner Shelf

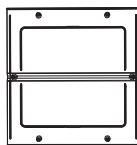

AHC (x5)
Skylight



AFL (x10)
Roof Support Strip

PARTS IDENTIFIER

BOX 2

SHED PARTS BOX

Parts shown at 4% of actual size

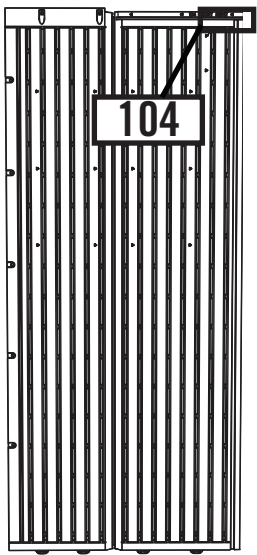

AGY (x1)
Corner Wall Panel 104

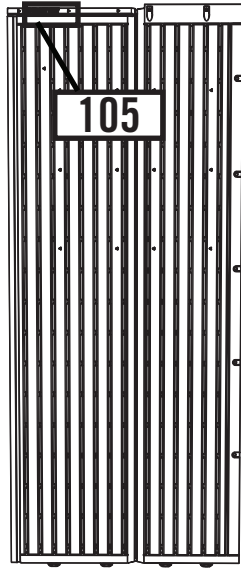

AGN (x1)
Corner Wall Panel 105

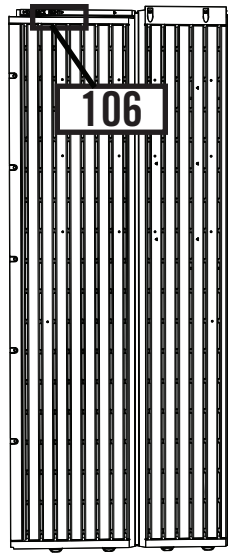

AGW (x1)
Corner Wall Panel 106

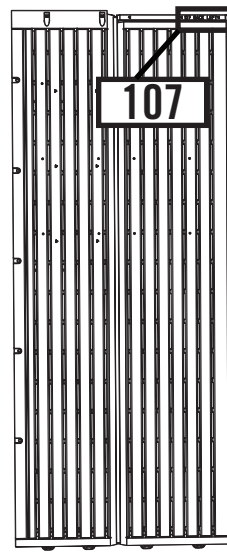

AGL (x1)
Corner Wall Panel 107

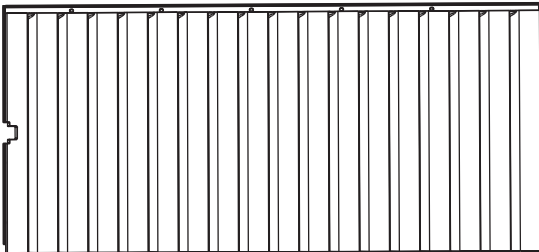

AHD (x8)
Wall Panel

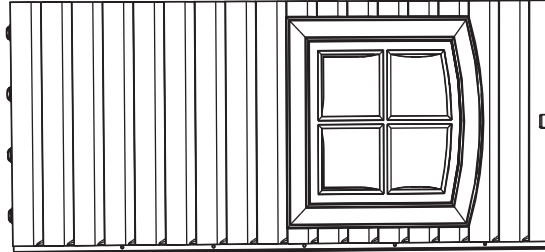

AHH (x2)
Window Wall Panel

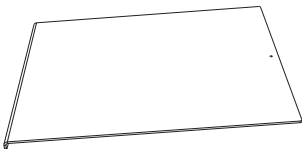

AHE (x2)
Window

PARTS & HARDWARE IDENTIFIER

BOX 2 (CONT.)

6402 SMALL PARTS BOX [CAU]

Parts not shown to scale



AIW (x1)
Wood Block



AIX (x4)
Wood Shim

TRUSS FRAME ASSEMBLY HARDWARE [BEA] x4

Parts shown to scale (*Unless otherwise noted)



ADJ (x2)
1/4" Cap Nut



ADK (x6)
#10 Cap Nut

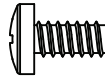

ADY (x6)
#10 Pan-Head Screw

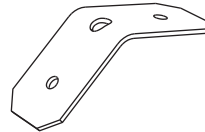

***AIP** (x1)
Truss Connector

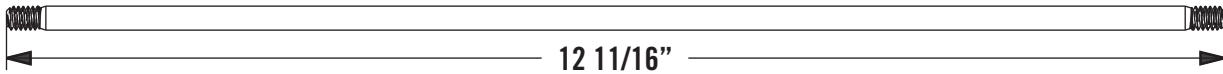

***ADH** (x1)
1/4" Threaded Rod

WALL INSTALLATION HARDWARE [BEB]

Parts shown to scale (*Unless otherwise noted)

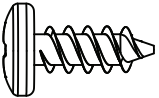

ADZ (x85)
1/4" x 5/8" Pan-Head Screw

SHELF INSTALLATION HARDWARE

Parts shown to scale (*Unless otherwise noted)

Corner Shelf Installation Hardware [BHI] x2

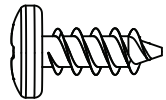

ADZ (x4)
1/4" x 5/8" Pan-Head Screw

90" & 30" Shelf Installation Hardware [BHH] x3

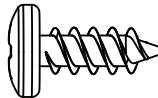

ADZ (x14)
1/4" x 5/8" Pan-Head Screw



***AIY** (x2)
Shelf Support Bracket

FLOOR ASSEMBLY HARDWARE [BQH]

Hardware shown at actual size

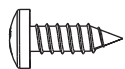

BQC (x20)
#8 x 1/2" Pan-Head Screw
(Only 16 used)

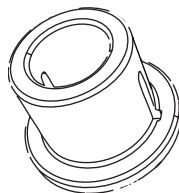

AHO (x2)
Door Hinge Bushing



ADC (x1)
#2 Phillips Bit

PARTS & HARDWARE IDENTIFIER

BOX 2 (CONT.)

GABLE ASSEMBLY HARDWARE [BHV] x2

Parts shown to scale (*Unless otherwise noted)

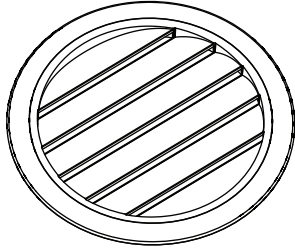

***AGP** (x1)
Louvered Vent

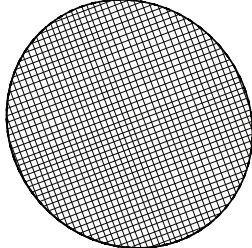

***AIQ** (x1)
Vent Screen

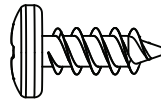

ADZ (x4)
1/4" x 5/8" Pan-Head Screw
(Only 4 used)



AHS (x2)
End Plug
(Only 2 used)

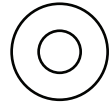

AEE (x5)
#10 x 1/2"
Flat Washer

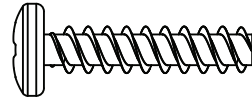

ADV (x6)
1/4" x 1 1/8" Pan-Head Screw
(Only 6 used)

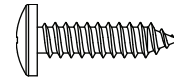

ADW (x5)
#10 x 3/4" Pan-Head Screw

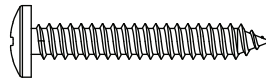

ACB (x1)
#10 x 1 1/4" Pan-Head Screw
(Not used in this model)

LEFT DOOR ASSEMBLY HARDWARE [BEF]

Parts shown to scale (*Unless otherwise noted)

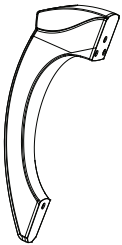

***AHZ** (x1)
Left Door Handle

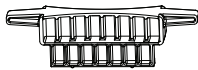

***AHM** (x2)
Deadbolt Latch

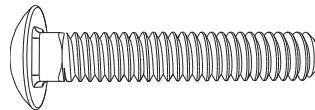

ABU (x2)
1/4" x 1 1/2" Carriage Bolt

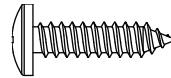

ADW (x3)
#10 x 3/4" Pan-Head Screw

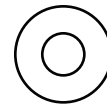

AEE (x3)
#10 x 1/2" Flat Washer



ADJ (x2)
1/4" Cap Nut



***AIA** (x1)
Left Door Lock Bracket

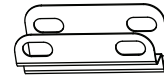

***AIB** (x1)
Left Door Strike Plate

RIGHT DOOR ASSEMBLY HARDWARE [BEG]

Parts shown to scale (*Unless otherwise noted)

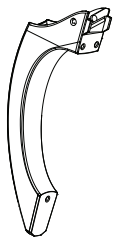

***AIK** (x1)
Right Door Handle

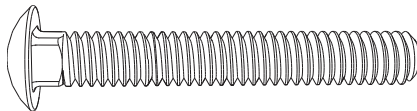

ABV (x2)
1/4" x 2" Carriage Bolt

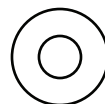

AEE (x5)
#10 x 1/2" Flat Washer
(Only 3 used)



ADB (x2)
3/8" x 1/2" Steel Spacer

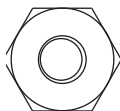

AAB (x2)
1/4" Centerlock Nut

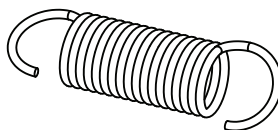

AHY (x1)
Latch Spring

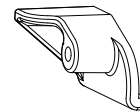

***AHW** (x1)
Latch Block

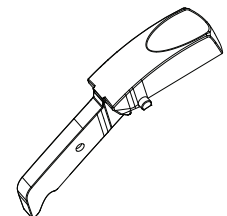

***AIO** (x1)
Thumb Lever

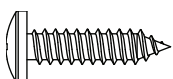

ADW (x4)
#10 x 3/4" Pan-Head Screw

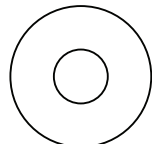

AEB (x2)
1/4" Flat Washer



***AHX** (x1)
Latch Cover Plate

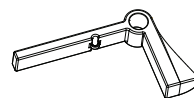

***AHV** (x1)
Door Latch

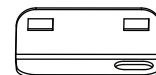

***AIL** (x1)
Right Door Lock Bracket

PARTS & HARDWARE IDENTIFIER

BOX 2 (CONT.)

DOOR & FRONT GABLE INSTALLATION HARDWARE [BHZ]

Parts shown to scale (*Unless otherwise noted)

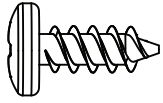

ADZ (x6)
1/4" x 5/8" Pan-Head Screw

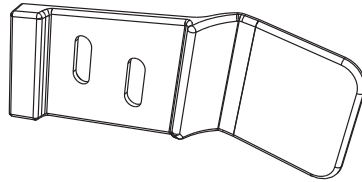

***AIC (x1)**
Left Gap Flap

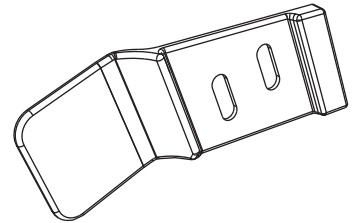

***AIM (x1)**
Right Gap Flap



AHP (x2)
Cotter Pin

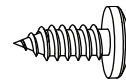

ADX (x4)
#10 x 1/2" Pan-Head Screw

TRUSS, REAR GABLE, & ROOF INSTALLATION HARDWARE BAG [CAO]

Parts shown to scale (*Unless otherwise noted)

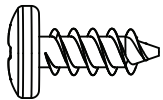

ADZ (x152)
1/4" x 5/8" Pan-Head Screw

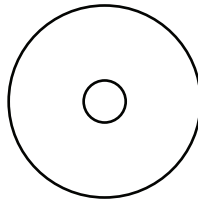

AED (x30)
#10 x 1" Fender Washer

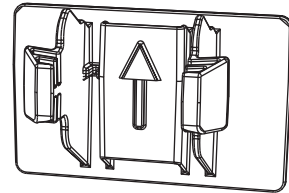

***AXX (x2)**
Truss Hole Insert

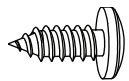

ADX (x30)
#10 x 1/2" Pan-Head Screw

WINDOW INSTALLATION HARDWARE [BEJ] x2

Parts shown to scale (*Unless otherwise noted)

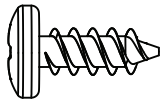

ADZ (x4)
1/4" x 5/8" Pan-Head Screw

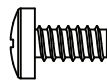

ADY (x1)
#10 x 3/8" Pan-Head Screw

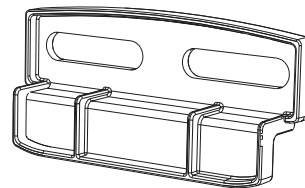

***AIS (x2)**
Window Latch



TOOLS AND HARDWARE REQUIRED FOR THIS PAGE



Concrete (1.5 cu. yd.)

SEC 1

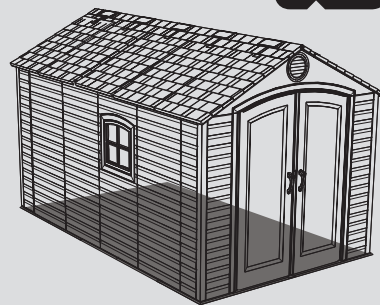

SEC

1.1

SITE PREPARATION - CONCRETE PLATFORM PREPARATION

The actual dimensions of your shed (at its widest and longest points) are 8' x 12' 6". Ensure you select a site that will accommodate these measurements. The base of the shed is slightly smaller than this, so you will need to create a level surface that is at least 93 1/2" x 148". We recommend using a level cement or patio style surface. This will provide the best long-term performance for your shed.



Note: Shed Extension Kits are available for this shed. Please consider possible shed expansion when planning the site for your shed. See back cover of this manual for information on ordering accessories.

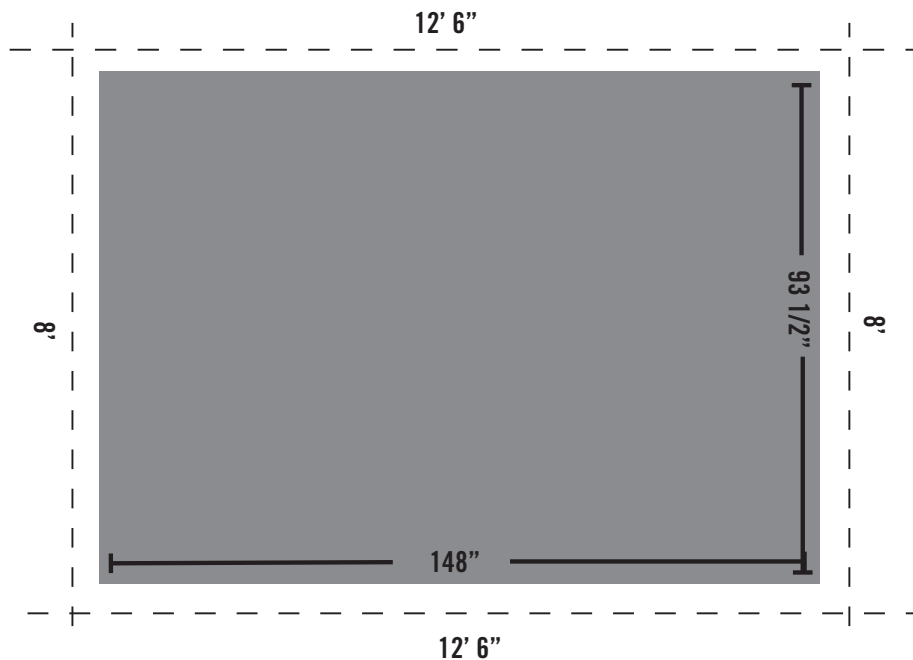

Note: Surface must be leveled before installation. If the surface is not properly leveled, the Outdoor Shed will not assemble or function correctly. Proper surface leveling will save you time in the long run, so please do not ignore this step.



Note: Any platform or similar structure should be built above ground in order to avoid water pooling inside the Shed.



TOOLS AND HARDWARE REQUIRED FOR THIS PAGE



2" x 4" x 90 1/2" (x11) (Not included)



2" x 4" x 148" (x2) (Not included)

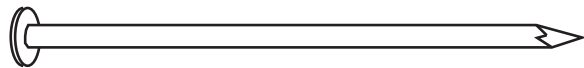

16d 3" Common Nail (x44) (Not included)

SEC 1

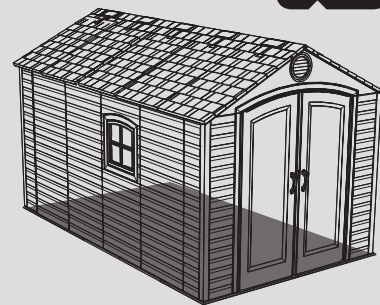

SEC

1.2

ALTERNATIVE SITE PREPARATION: OPTION 1 - WOOD PLATFORM ASSEMBLY

Ensure all lumber used is treated and approved for outdoor use. Build outside frame to 93 1/2" x 148" outside dimensions:

! Note: Whenever possible, you should use the surfaces described on Page 7. When this is not possible, we recommend you use a wood platform or a filled wood frame.

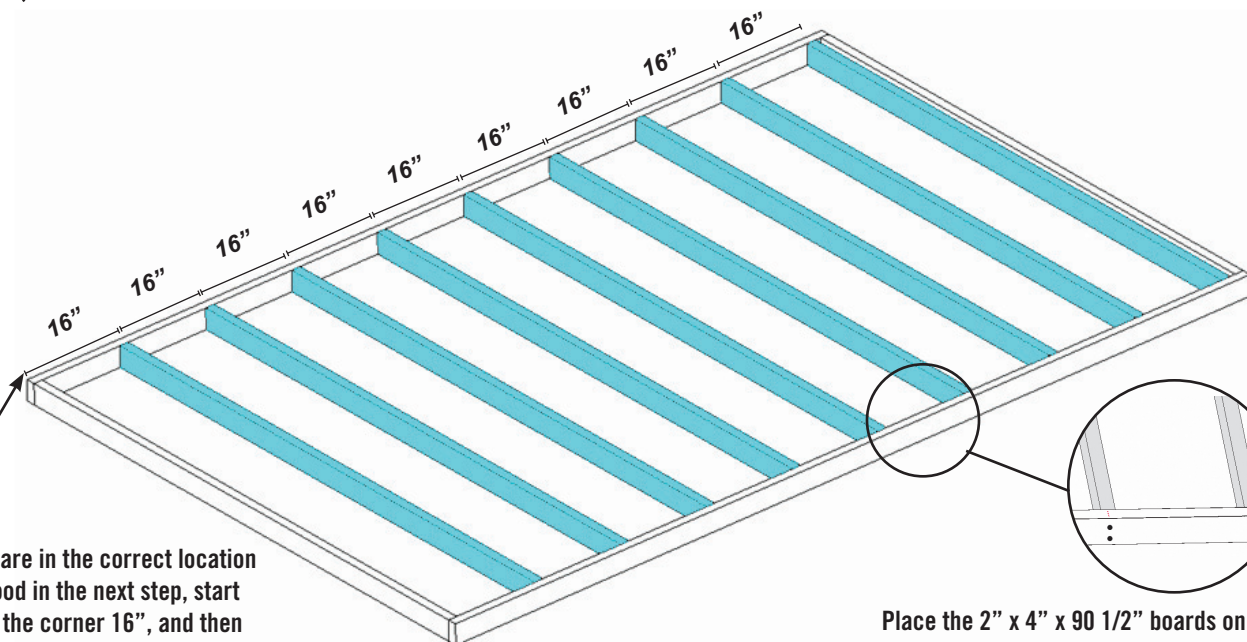
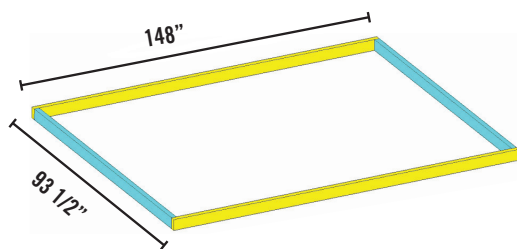

To ensure studs are in the correct location for nailing plywood in the next step, start measuring from the corner 16", and then measure from center to center.

Place the 2" x 4" x 90 1/2" boards on the inside of the frame. Nail each board in place with the 16d nails.

! Note: All lumber must be rated for outdoor use.

! Note: Surface must be leveled before installation. If the surface is not properly leveled, the Outdoor Shed will not assemble or function correctly. Proper surface leveling will save you time in the long run, so please do not ignore this step.



TOOLS AND HARDWARE REQUIRED FOR THIS PAGE

SEC 1



48" x 93 1/2" x 3/4" Treated Plywood (x3)
(Not included)



4" x 93 1/2" x 3/4" Treated Plywood (x1)
(Not included)

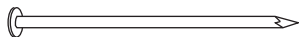

8d 1 1/2" Common Nail (x56)
(Not included)

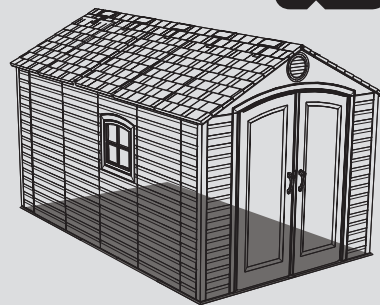

SEC

1.3

ALTERNATIVE SITE PREPARATION: OPTION 1 - WOOD PLATFORM ASSEMBLY (CONT)

Square up the frame by measuring from corner to corner. Measurement A should equal Measurement B.

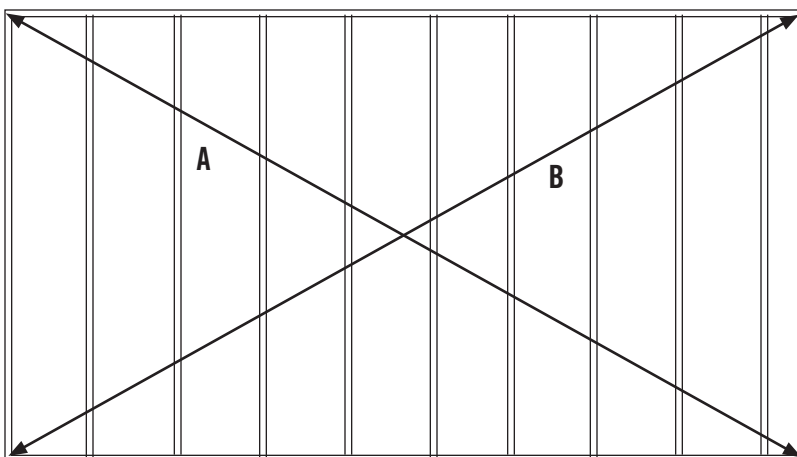

Note: All lumber must be rated for outdoor use.

SEC

1.4

Cut Plywood into sizes called for on previous page. Arrange the Plywood according to the diagram and nail into place with 8d x 1 1/2" nails. Place platform in the desired location. If platform does not rest level on the ground, build up low points with loose dirt until platform is stable. Drill three evenly spaced 1/2" drain holes in plywood between each 2" x 4" joist.

Drain holes





TOOLS AND HARDWARE REQUIRED FOR THIS PAGE

SEC 1



2" x 4" x 148" (x2) (Not included)

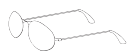

2" x 6" x 89" (x2) (Not included)

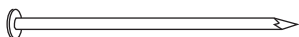

8d 1 1/2" Common Nail (x16)
(Not included)



Pea Gravel (12.5 Cubic Feet)
(Not included)



L-Bracket (x4)
(Not included)

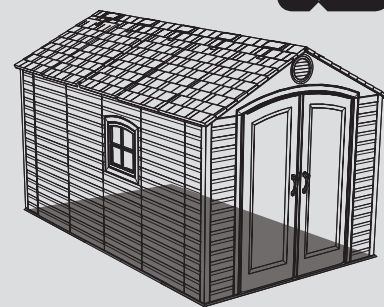

SEC 1.5

ALTERNATIVE SITE PREPARATION: OPTION 2 - FILLED WOOD FRAME ASSEMBLY

Cut outside frame to 8' x 12' 6" outside dimensions. Lay boards flat so widest parts face up. Ensure frame is level. Square up the frame by measuring from corner to corner. Measurement A should equal Measurement B. Nail an L-Bracket on each corner of the frame with 8d nails. Place platform in the desired location. If platform does not rest level on the ground, build up low points with loose dirt or "Pea" gravel, until platform is stable.

! Note: Whenever possible you should use the surfaces described on Page 7.

! Note: All lumber must be rated for outdoor use.

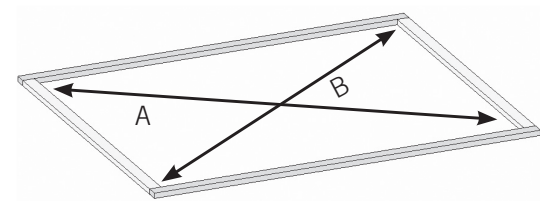
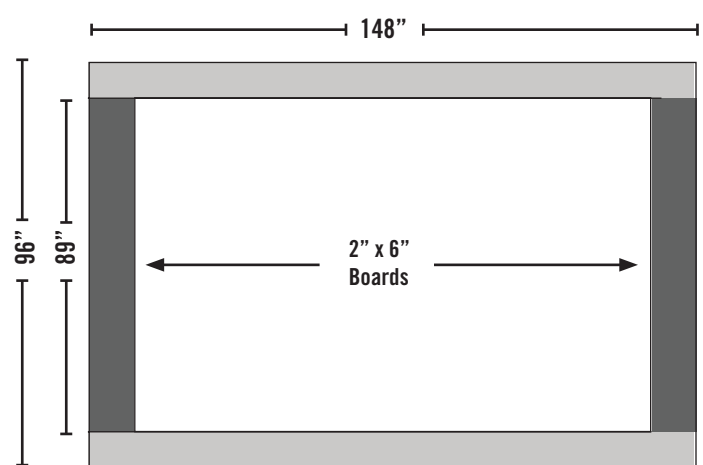

SEC 1.6

Once all boards are level and do not wobble, pack "Pea" gravel around the outside of the frame, and slope away from frame.

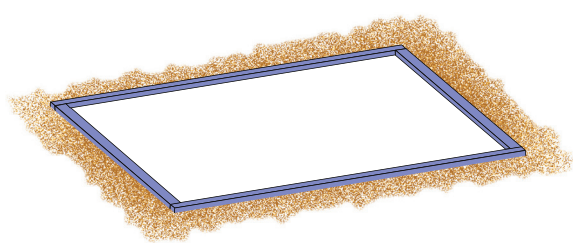

SEC 1.7

Now fill the inside of the frame with "Pea" gravel. Use a leveling board to scrape off extra fill material and to level the surface.

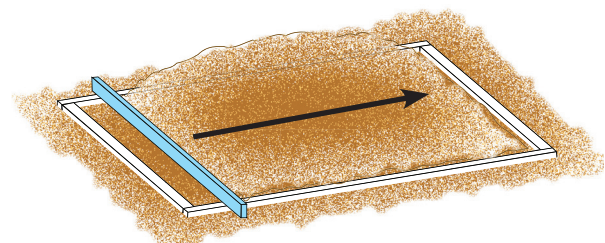

2" x 4" x 8' Leveling Board (x1)

SEC 2 FLOOR ASSEMBLY

HARDWARE REQUIRED

Hardware shown at actual size

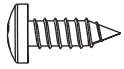

BQC (x20)
#8 x 1/2" Pan-Head Screw
(Only 16 are used)

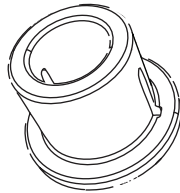

AHO (x2)
Door Hinge Bushing



ADC (x1)
#2 Phillips Bit

PLASTIC PARTS REQUIRED

Parts shown at 4% of actual size

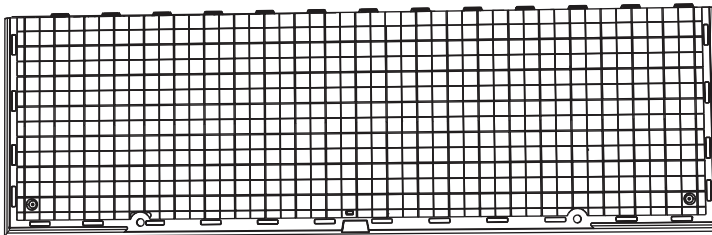

AGR (x2)
Outer Floor Panel

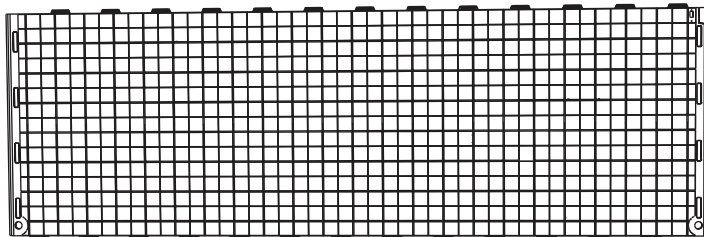

AFX (x3)
Center Floor Panel

TOOLS REQUIRED

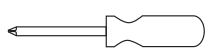

Phillips Screwdriver

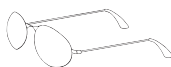

Safety Glasses



ADC (x1)
#2 Phillips Bit (Included)

HARDWARE BAG REQUIRED: BQH



TOOLS AND HARDWARE REQUIRED FOR THIS PAGE

SEC 2

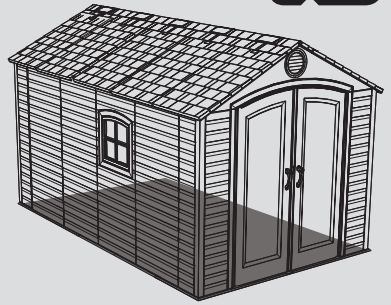

NO HARDWARE REQUIRED FOR THIS STEP

SEC

FLOOR ASSEMBLY

2.1

Lay an **Outer Floor Panel (AGR)** flat on the ground. Hold a **Center Floor Panel (AFX)** at an angle as shown and fit tabs into slots. Lay Center Floor Panel flat.

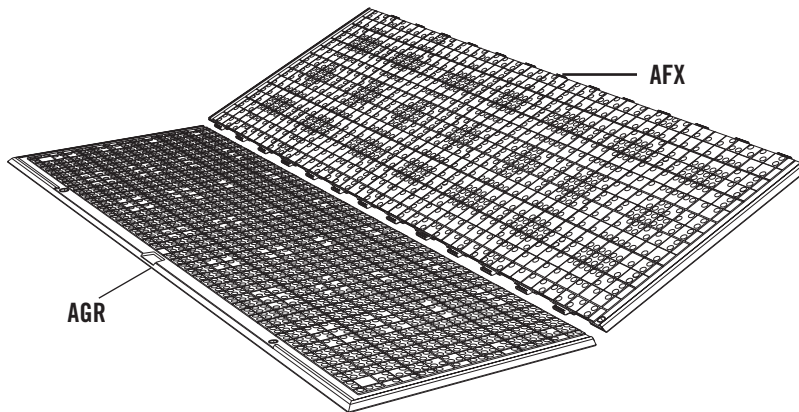

SEC

2.2

Hold the second **Center Floor Panel (AFX)** at an angle as shown and fit tabs into slots. Lay Center Floor Panel flat.

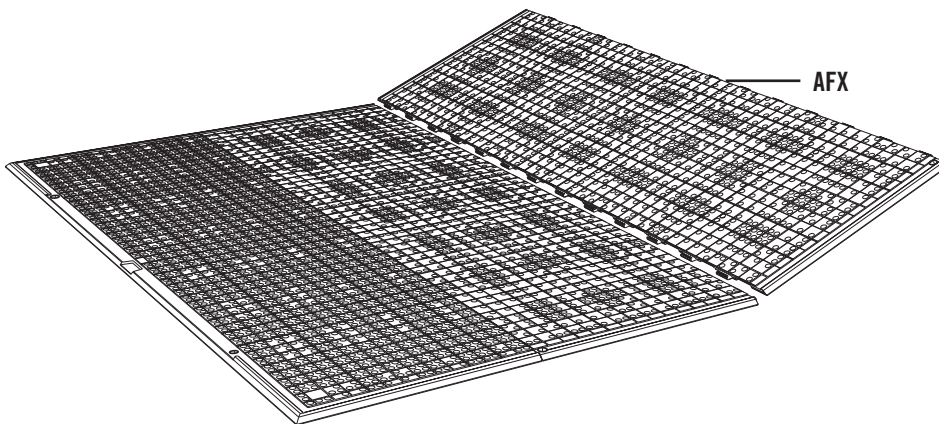

CAUTION

Sharp objects may damage your floor. If resting sharp, heavy objects on your shed floor, place a block of wood between the sharp object and floor.



TOOLS AND HARDWARE REQUIRED FOR THIS PAGE

SEC 2

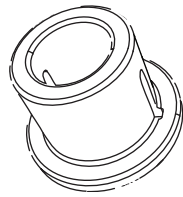

AHO (x2)

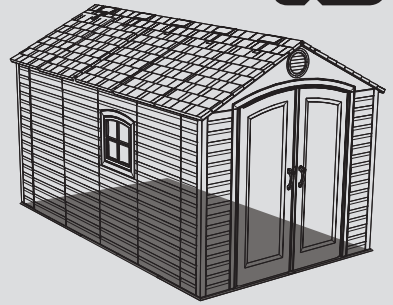

SEC

2.3

Connect the last **Center Floor Panel (AFX)** and then the last **Outer Floor Panel (AGR)** to the Floor as shown.

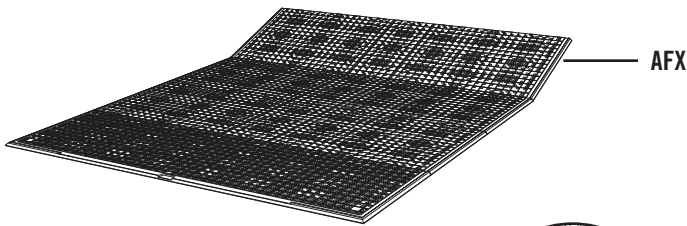

AFX

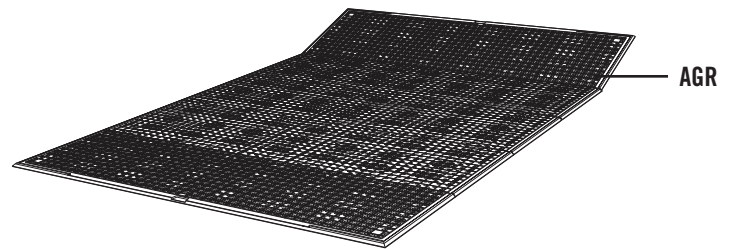

AGR

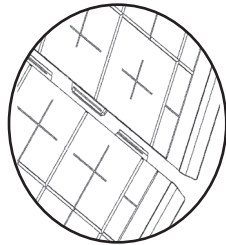

SEC

2.4

Decide which end will be the front of your shed. Lift the Floor Panels up enough to slide the two (2) **Door Hinge Bushings (AHO)** under and up through the holes in the Floor Panels as shown. **These will be used later when installing the Doors.**

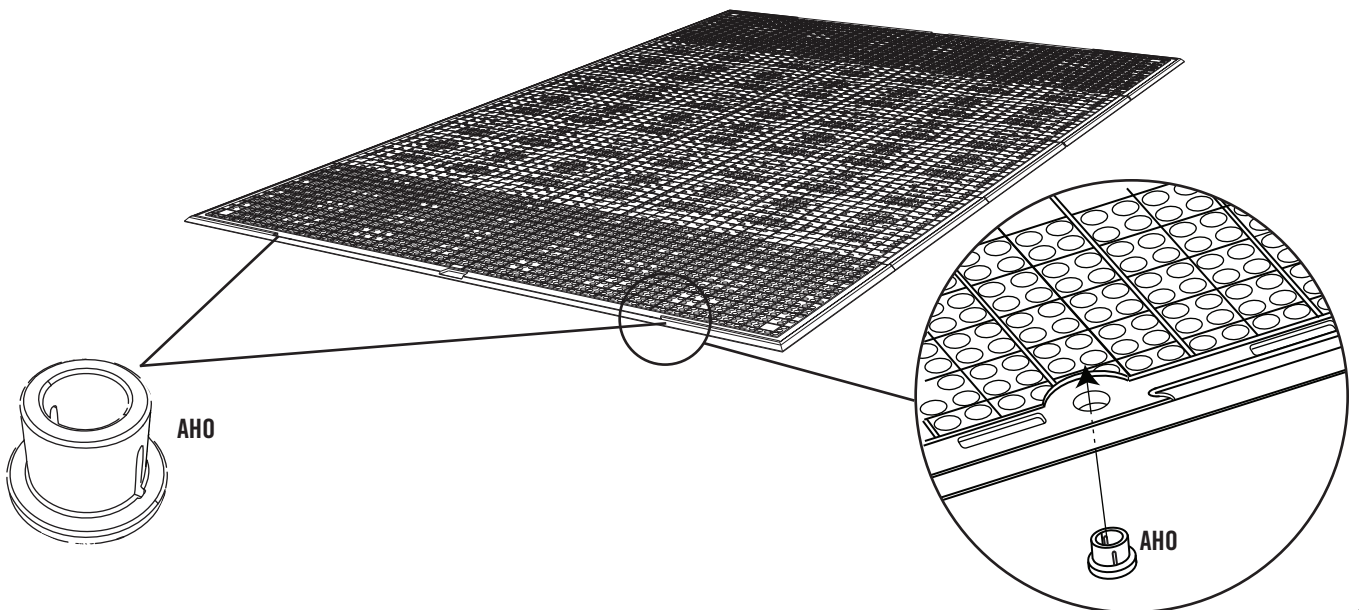

AHO

AHO



TOOLS AND HARDWARE REQUIRED FOR THIS PAGE

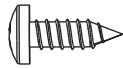
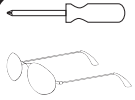

BQC (x20)
(Only 16 are used)

SEC 2

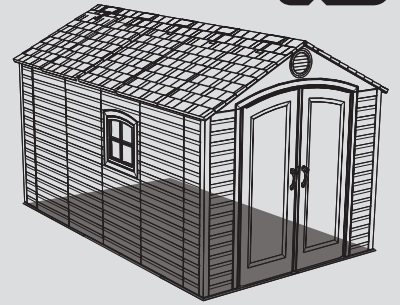

SEC

2.5

Face the seam of the two adjacent Floor Panels. Insert two (2) **#8 x 1/2" Pan-Head Screws (BQC)** near the seam of a Floor Panel and down into the tab of the adjacent Floor Panel at the locations shown. **Repeat this step for both sides of each seam as shown.**

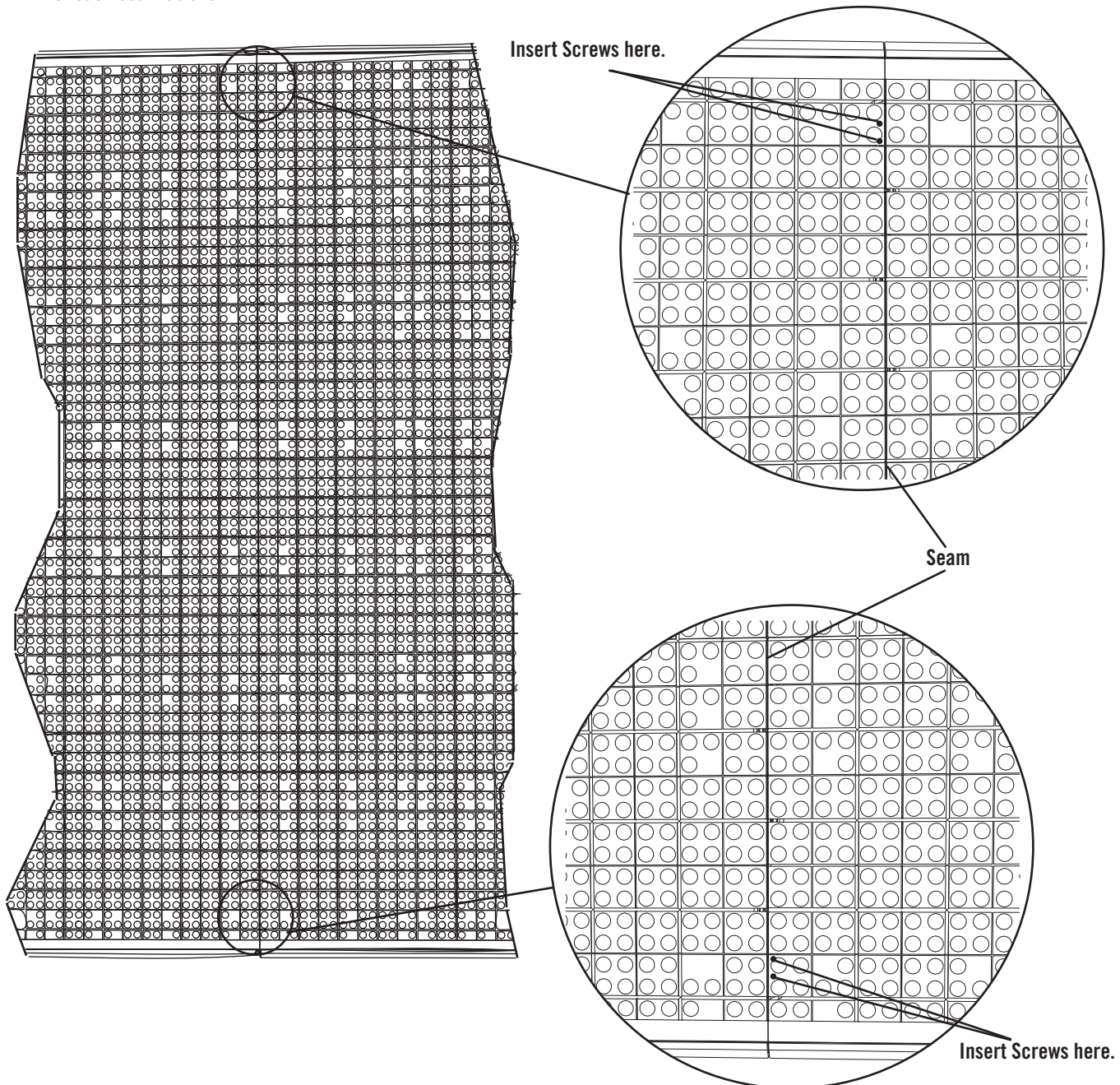



TOOLS AND HARDWARE REQUIRED FOR THIS PAGE

SEC 2



IF YOU PLAN ON ANCHORING YOUR SHED, CHECK WITH YOUR LOCAL HARDWARE STORE FOR SUITABLE HARDWARE.

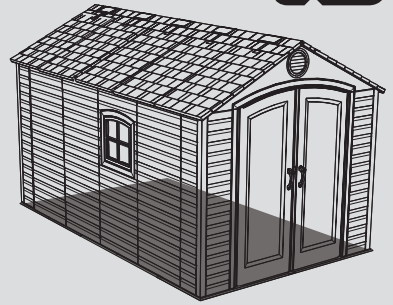

SEC

ANCHORING THE SHED

2.6

If you plan on anchoring your shed, you can anchor it to your platform through the four indentations near the corners of the floor. The anchoring hardware used depends on the platform. If you have a concrete platform, we recommend using four (4) 3/8" Anchor Bolts and four (4) 3/8" x 1" Flat Washers. If you have a wood framed platform, we recommend using four (4) 3/8" Lag Bolts and four (4) 3/8" x 1" Flat Washers. Do not exceed a 3/8" diameter bolt. Refer to your local hardware store for this hardware. **Do not tighten anchoring hardware until instructed to do so at the end of these instructions.**

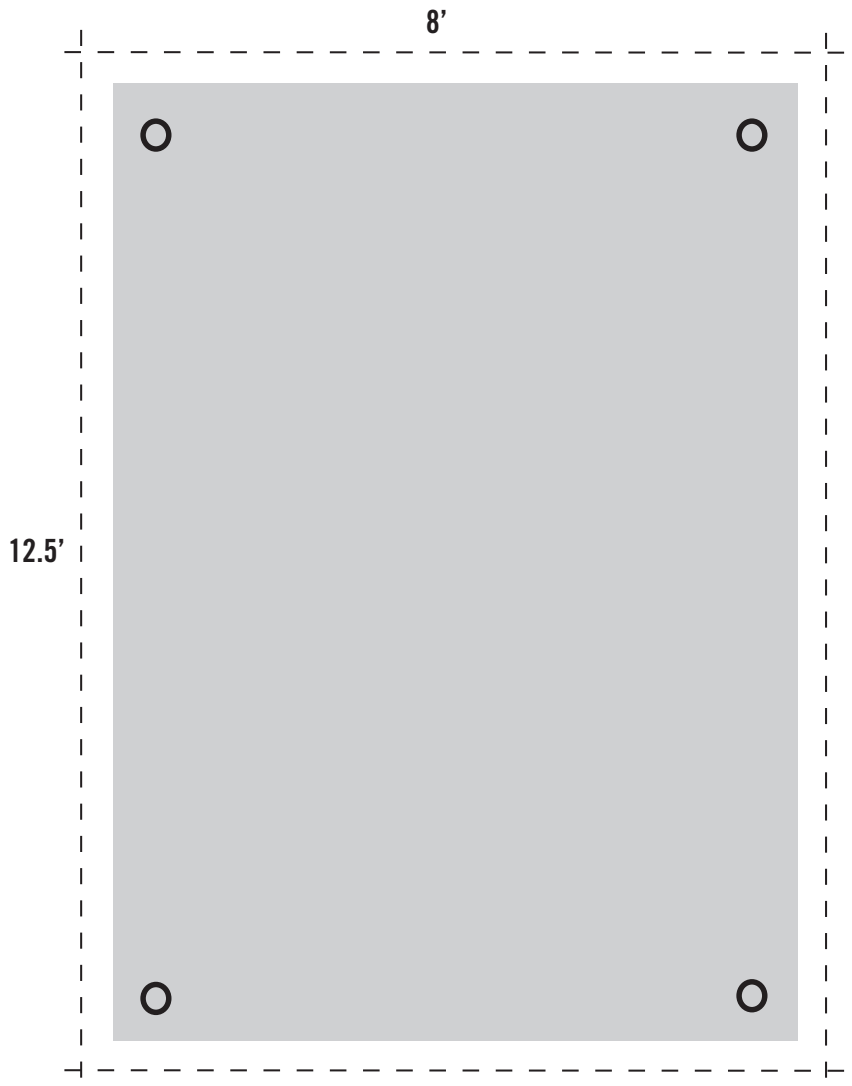

WARNING

Failure to anchor the shed may result in property damage and/or personal injury.

SEC 3 TRUSS ASSEMBLY

HARDWARE REQUIRED

HARDWARE BAG REQUIRED: BEA (x4)

Hardware shown at actual size

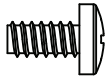

ADY (x24)
#10 x 3/8" Screw



ADJ (x8)
1/4" Cap Nut



ADK (x24)
#10 Cap Nut

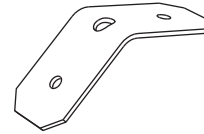

***AIP (x4)**
Truss Connector

Part shown at 50% of actual size

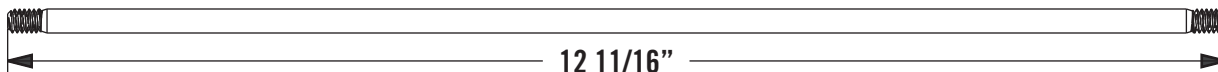

ADH (x4)
1/4" Threaded Rod

METAL PARTS REQUIRED

METAL PARTS KITS 1 & 2 REQUIRED: CAS, CAT

Parts shown at 8% of actual size (*Unless indicated otherwise)

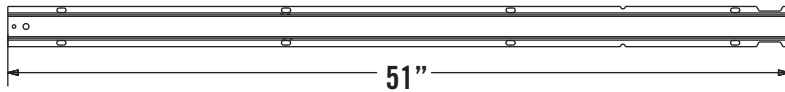

AFH (x8)
Truss Gutter Channel

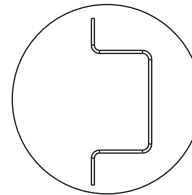

AFG (x4)
Roof Truss Brace (Not to Scale)

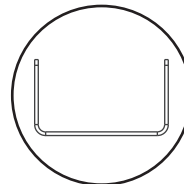

TOOLS REQUIRED

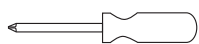

Phillips Screwdriver



7/16" Wrench



3/8" Wrench

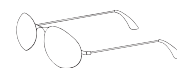

Safety Glasses



TOOLS AND HARDWARE REQUIRED FOR THIS PAGE

SEC 3



3/8"

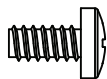
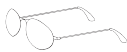

ADY (x4)



ADK (x4)

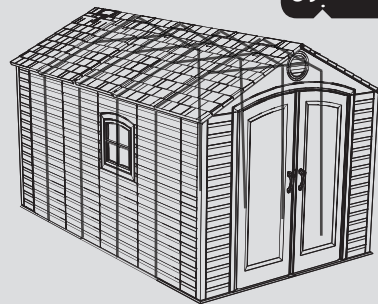

SEC

TRUSS ASSEMBLY

3.1

Stand a **Truss Gutter Channel (AFH)** upright and set a **Truss Connector (AIP)** inside the end of the Channel as shown. Align the holes and secure with one (1) #10 x 3/8" Pan-Head Screw (ADY) and one (1) #10 Cap Nut (ADK).

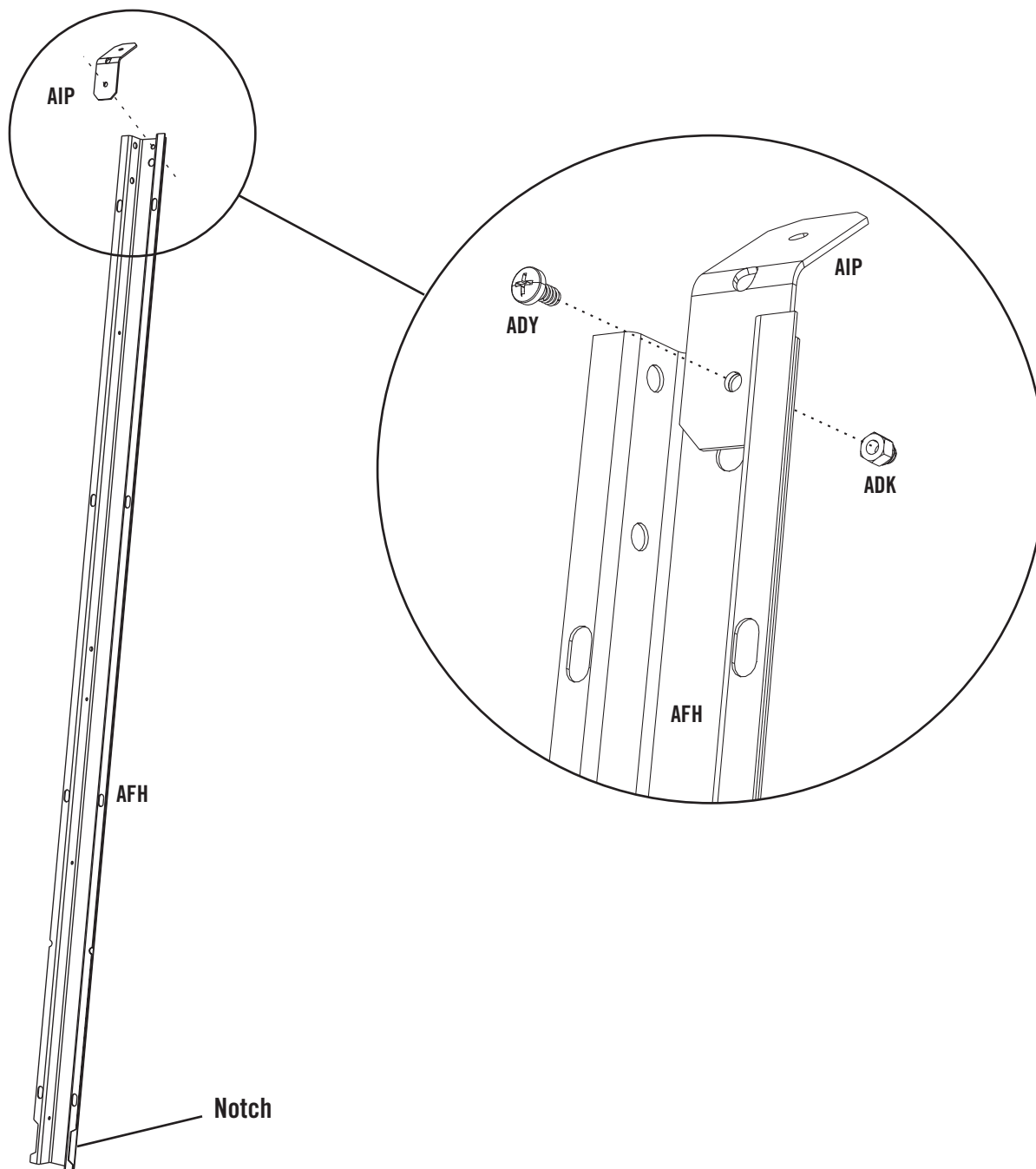



TOOLS AND HARDWARE REQUIRED FOR THIS PAGE

SEC 3

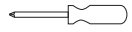

3/8"

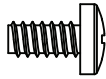

ADY (x4)



ADK (x4)

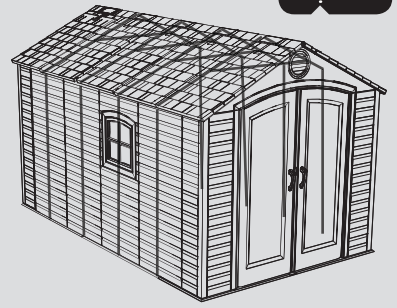

SEC

3.2

Connect another **Truss Gutter Channel (AFH)** to the Truss Connector using one (1) **#10 x 3/8" Pan-Head Screw (ADY)** and one (1) **#10 Cap Nut (ADK)**.

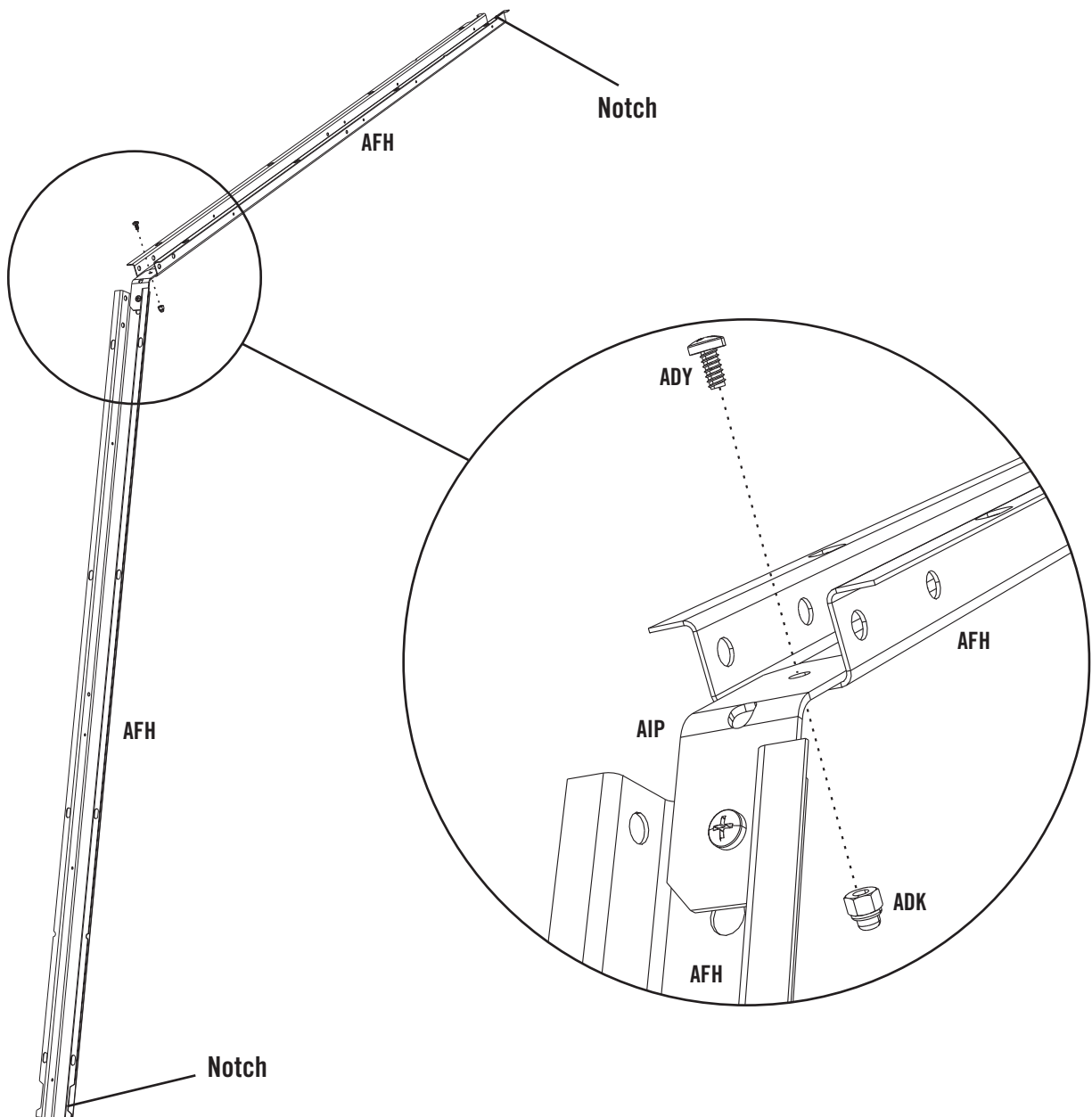



TOOLS AND HARDWARE REQUIRED FOR THIS PAGE

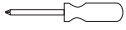

3/8"

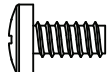

ADY (x16)



ADK (x16)

SEC 3

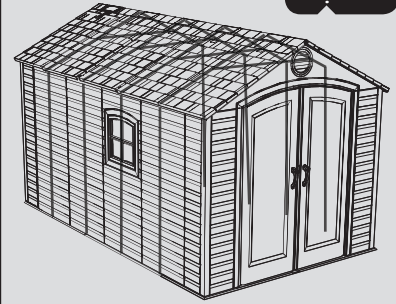

SEC

3.3

Lay the Truss Assembly on its side, and align the holes in a **Roof Truss Brace (AFG)** with those circled on the Truss Gutter Channels as shown.

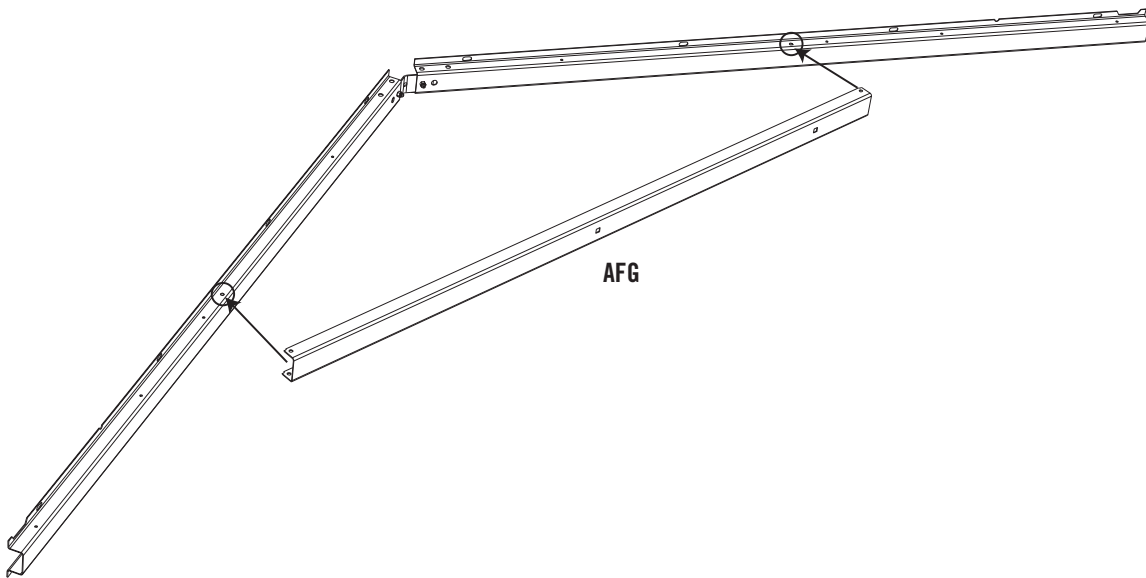

SEC

3.4

Secure the Roof Truss Brace to the Truss Gutter Channel using two (2) #10 x 3/8" Pan-Head Screws (ADY) and two (2) #10 Cap Nuts (ADK). Repeat this step for the other end of the Roof Truss Brace.

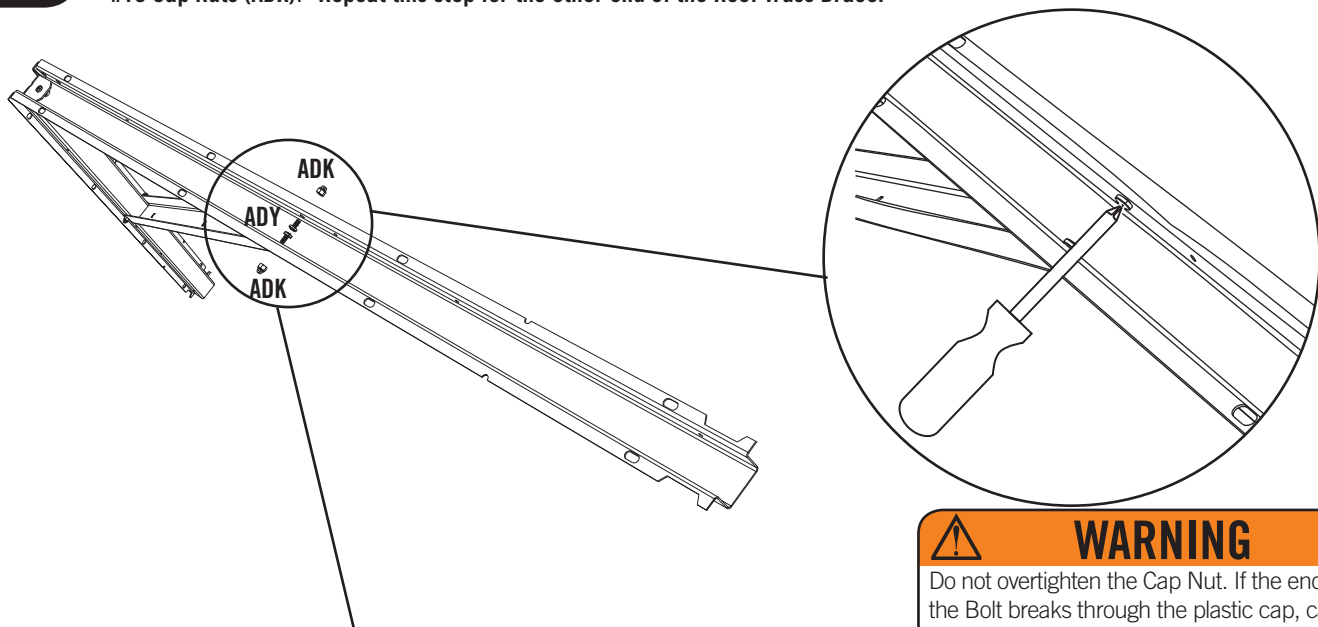

Note: The Cap Nuts goes on the outside of the Truss.



WARNING

Do not overtighten the Cap Nut. If the end of the Bolt breaks through the plastic cap, call our Customer Service Department. Exposed threads on the end of the Bolt may cause serious injuries.



TOOLS AND HARDWARE REQUIRED FOR THIS PAGE

SEC 3



7/16" (x2)



ADJ (x8)

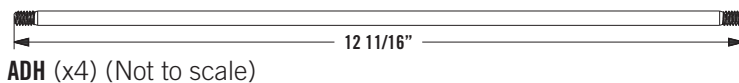

ADH (x4) (Not to scale)

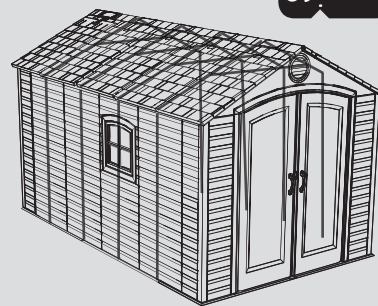

SEC

3.5

With the Truss Assembly on its side, slide one (1) 1/4" Threaded Rod (ADH) through the Roof Truss Brace and Truss Connector as shown. Secure the top and bottom of the 1/4" Threaded Rod with one (1) 1/4" Cap Nut (ADJ) on each end. Tighten all hardware. The 1/4" Threaded Rod will still spin freely. Set aside. **Repeat this section for all four Truss Assemblies.**

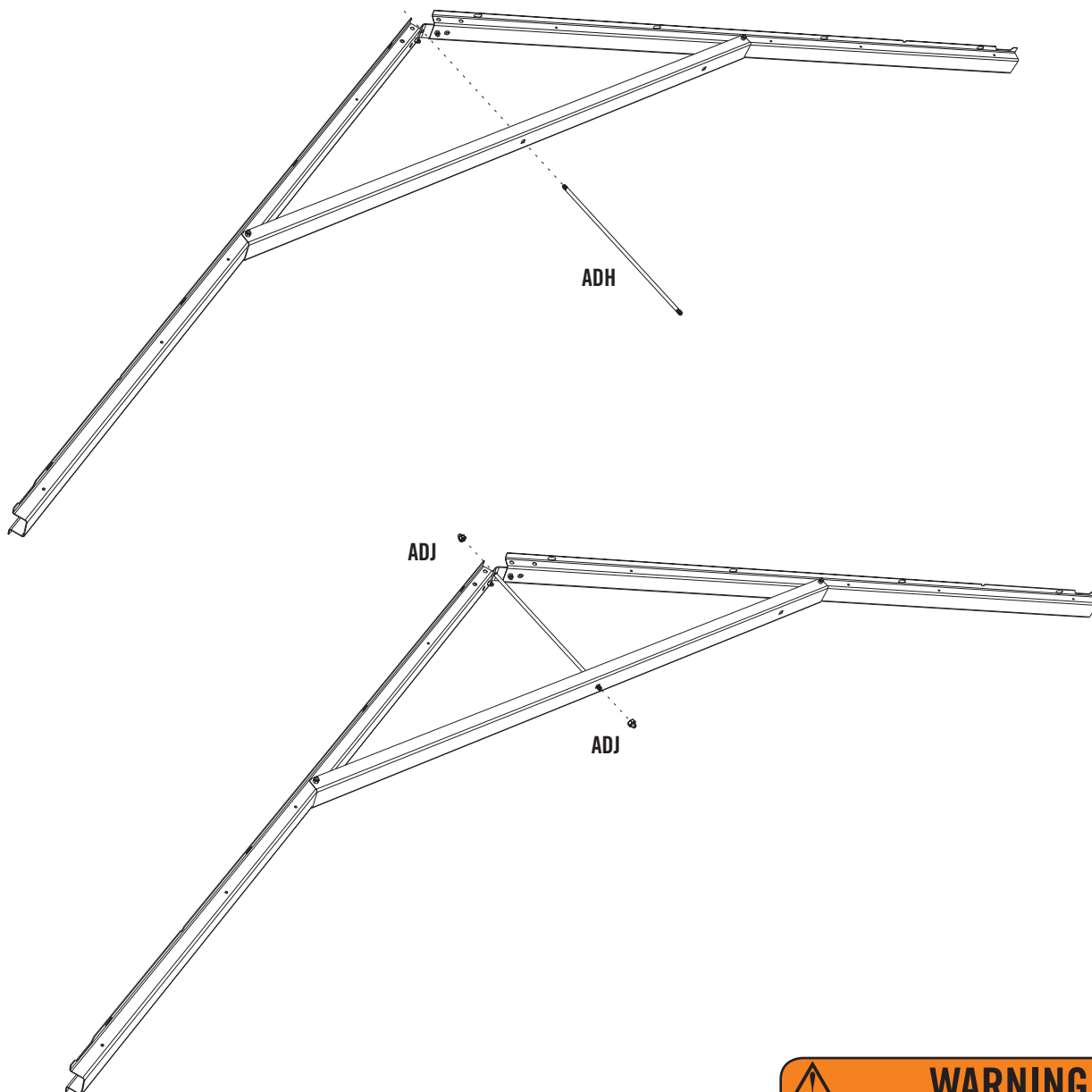

WARNING

Do not overtighten the Cap Nut.

SEC 4 WALL PANEL INSTALLATION

HARDWARE REQUIRED

HARDWARE BAG REQUIRED: BEB

Hardware shown at actual size

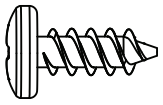

ADZ (x85)
1/4" x 5/8" Pan-Head Screw
(Not all screws will be used)

PLASTIC PARTS REQUIRED

LOCATED IN BOX 2

Part shown at 4% of actual size

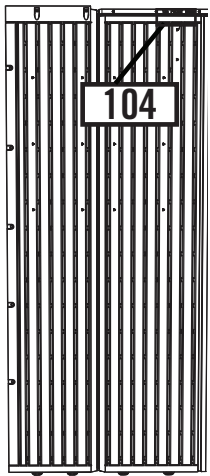

AGY (x1)
Corner Wall Panel 104

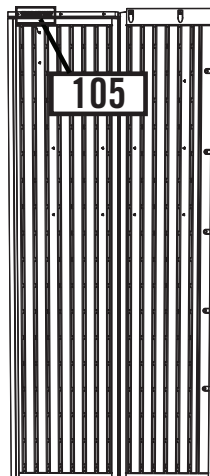

AGN (x1)
Corner Wall Panel 105

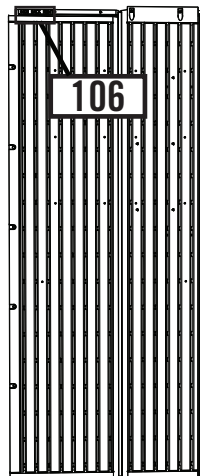

AGW (x1)
Corner Wall Panel 106

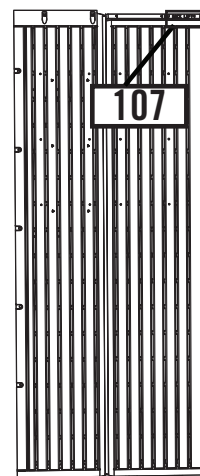

AGL (x1)
Corner Wall Panel 107

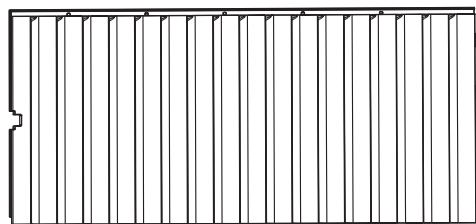

AHD (x8)
Wall Panel



AHH (x2)
Window Wall Panel

TOOLS REQUIRED

SMALL PARTS BOX REQUIRED: CAU



Phillips Screwdriver

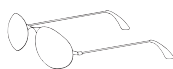

Safety Glasses



AIW (x1)
Wood Block (Included)



TOOLS AND HARDWARE REQUIRED FOR THIS PAGE

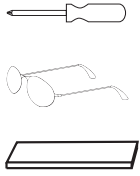

AIW (x1)
Wood Block



ADZ (x4)

SEC 4

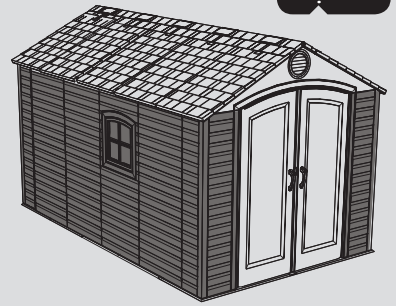

SEC

4.1

WALL PANEL INSTALLATION

Fold **Corner Wall Panel 104 (AGY)**. Insert tabs of the Panel into the right, front corner of your Floor (while facing where the Doors will be). Place a **Wood Block (AIW)** under the Floor Panel, directly under the first tab, then pull down on the Corner Wall Panel until the tab snaps into place. Move the Wood Block under the next tab and repeat.

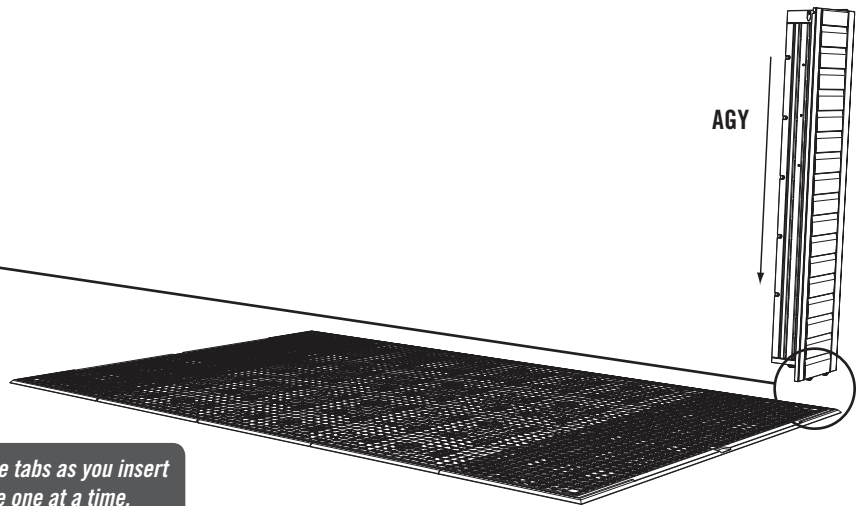
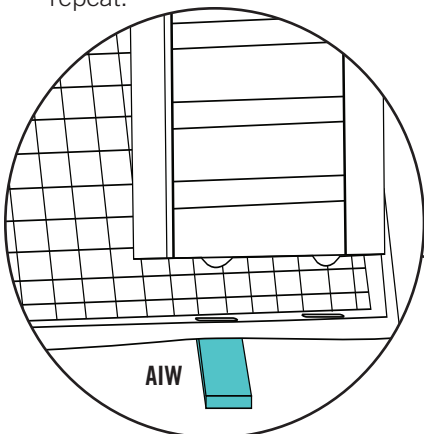

Note: Place the Wood Block (AIW) directly under the tabs as you insert them throughout the assembly. Snap tabs into place one at a time.

SEC

4.2

Snap three **Wall Panels (AHD)** and a **Window Wall Panel (AHH)** into place along the right side of the shed. **The Window Wall Panel may be inserted in any side Wall Panel position.** Ensure the tops of the Wall Panels are even and the holes align. Insert a **1/4" x 5/8" Pan-Head Screw (ADZ)** through the top hole of each set of Panels to fasten the Panels together as shown. You'll finish fastening the panels together towards the end of this section.

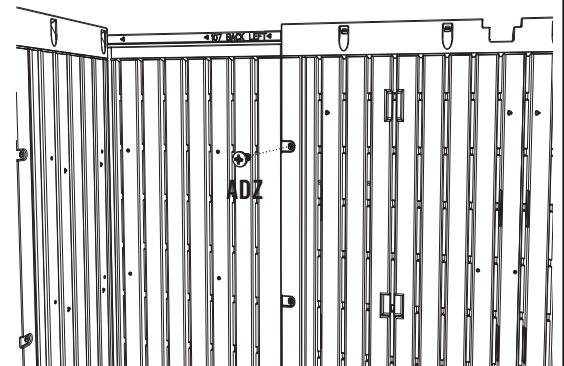
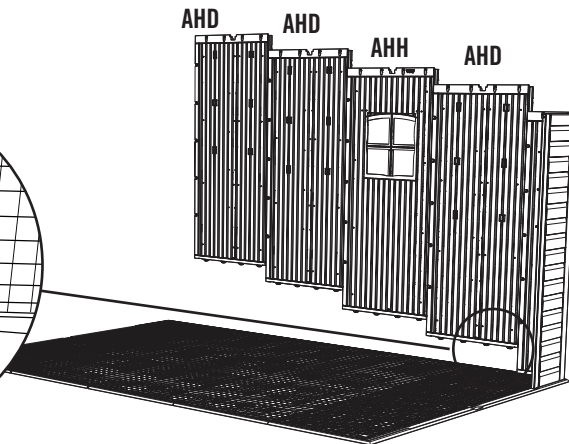
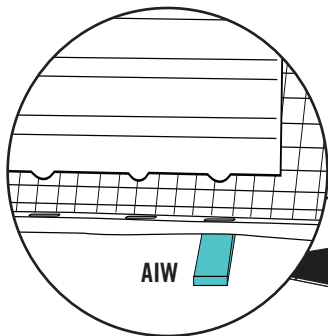

Note: A second person should apply pressure on opposite side of the Wall Panels for easier insertion of the Screw. Do not overtighten Screw.



TOOLS AND HARDWARE REQUIRED FOR THIS PAGE

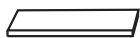
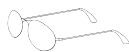
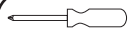

AIW (x1)
Wood Block



SEC 4

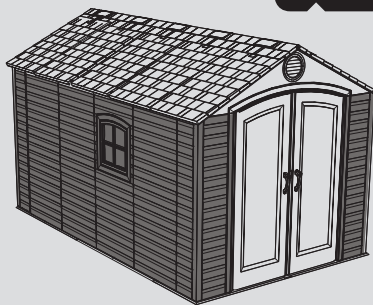

SEC

4.3

Fold **Corner Wall Panel 106 (AGW)**. Snap into place and fasten at the top hole with the required hardware.

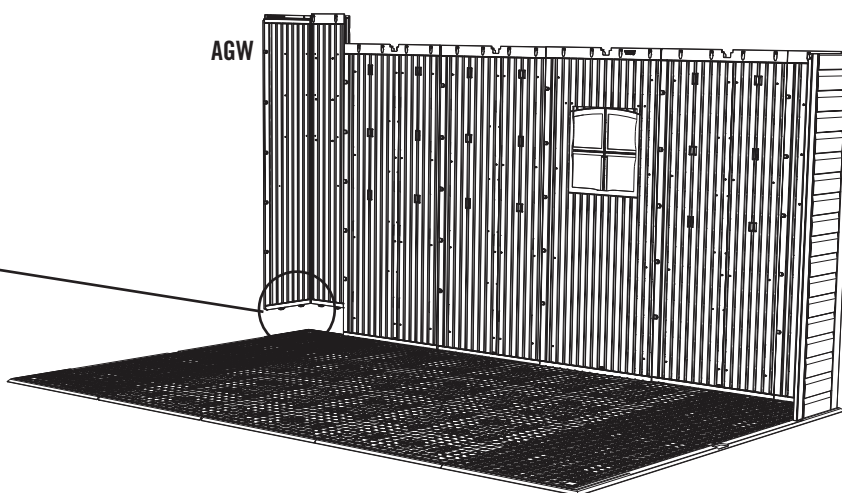
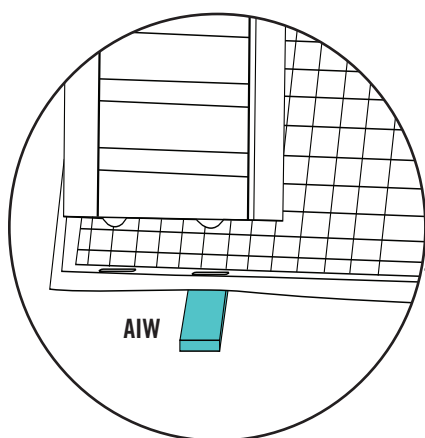

SEC

4.4

Insert two **Wall Panels (AHD)** along the back side of shed. Ensure the tops are level and the holes line up before fastening the Panels through the top holes using the required hardware.

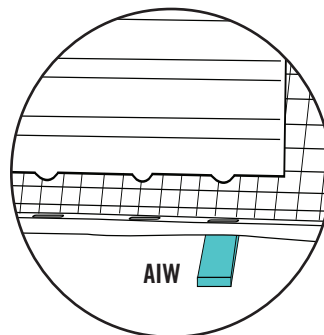
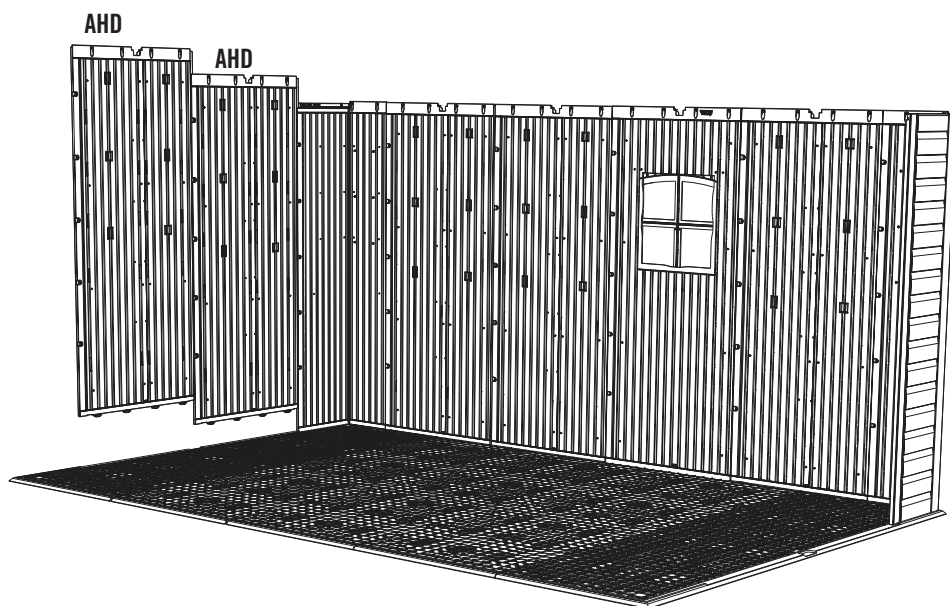



TOOLS AND HARDWARE REQUIRED FOR THIS PAGE

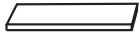
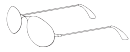
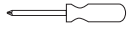

AIW (x1)
Wood Block



SEC 4

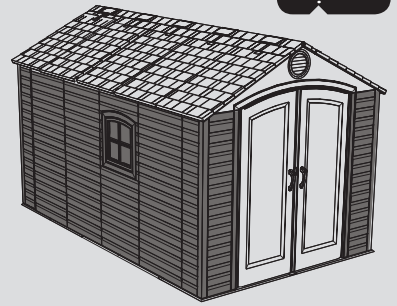

SEC

4.5

Fold **Corner Wall Panel 107 (AGL)** and fasten it to the rear Wall Panel through the top hole using the required hardware.

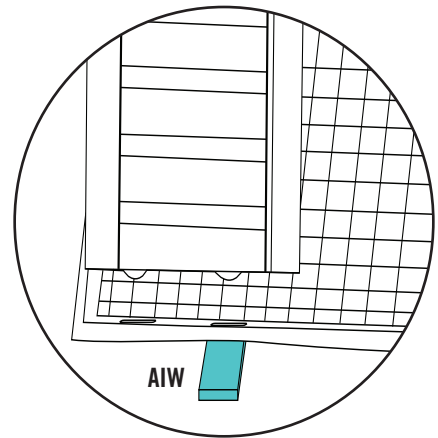
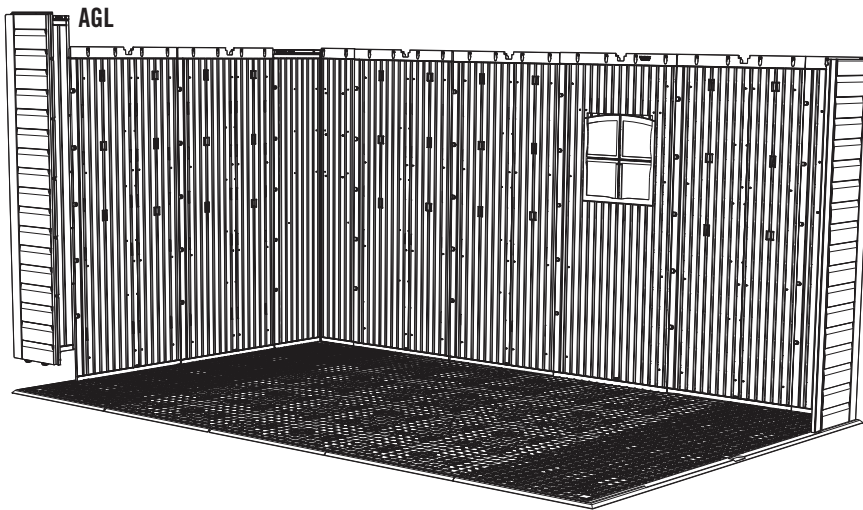

SEC

4.6

Snap three more **Wall Panels (AHD)** and a **Window Wall Panel (AHH)** into place along the left side of the shed. **The Window Wall Panel may be inserted in any side Wall Panel position.** Ensure the tops of the Wall Panels are even and the holes align. Insert a **1/4" x 5/8" Pan-Head Screw (ADZ)** through the top hole of each set of Panels to fasten the Panels together as shown.

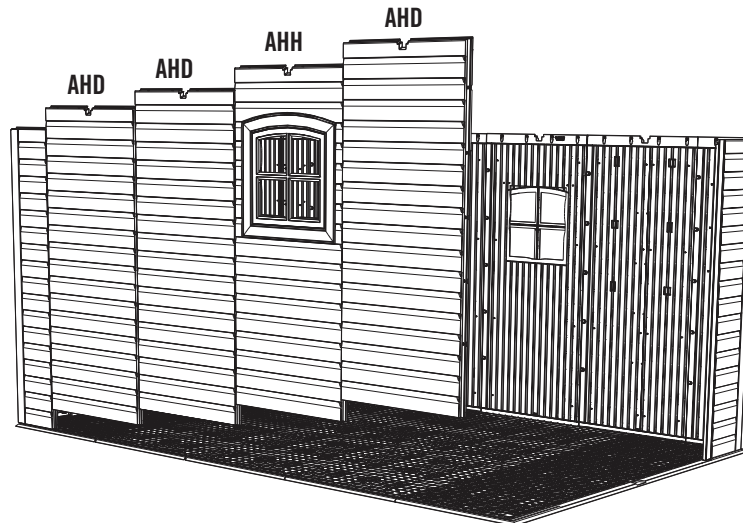



TOOLS AND HARDWARE REQUIRED FOR THIS PAGE

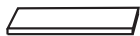
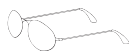
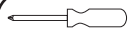

AIW (x1)
Wood Block



SEC 4

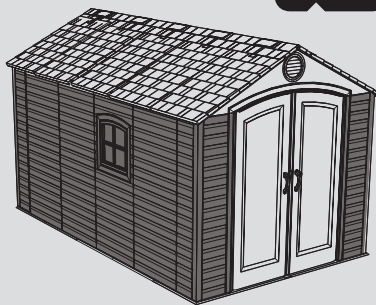

SEC

4.7

Fold **Corner Wall Panel 105 (AGN)** and snap it into place at the left, front corner of the Floor as shown. Fasten it to the Wall Panel through the top hole using the required hardware. Finish fastening all Panels together with the rest of the **1/4" x 5/8" Pan-Head Screws (ADZ)** for all holes.

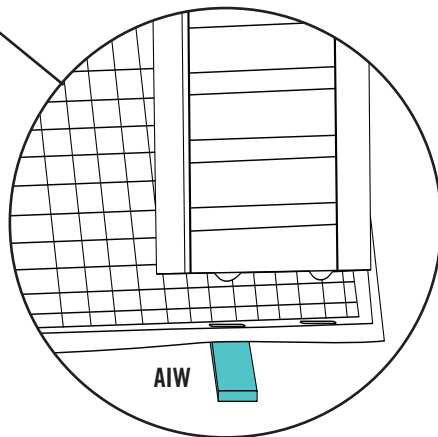
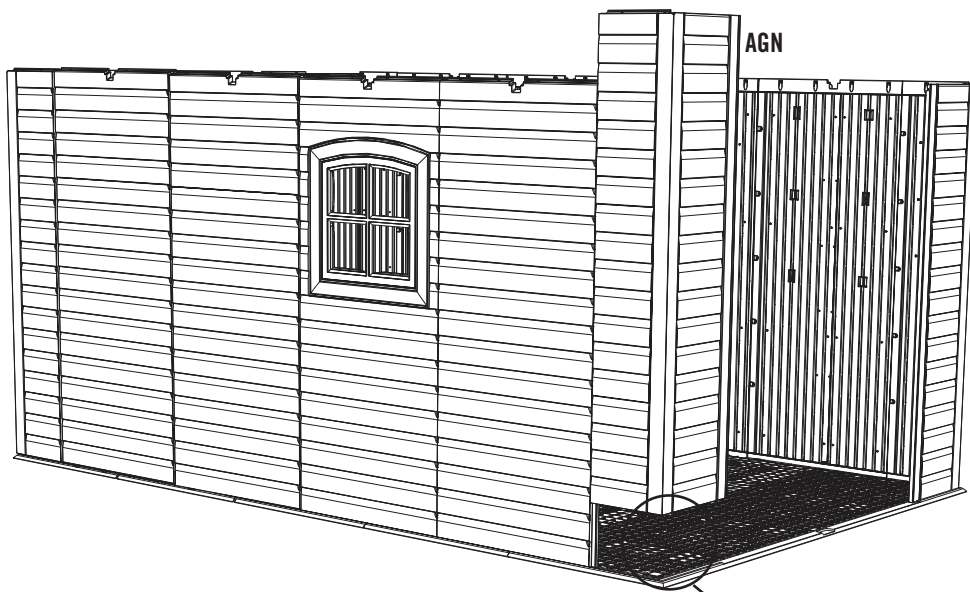

SEC 5 LEFT DOOR ASSEMBLY

HARDWARE REQUIRED

HARDWARE BAG REQUIRED: BEF

Hardware shown at actual size

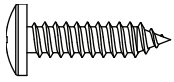

ADW (x3)
#10 x 3/4" Pan-Head Screw

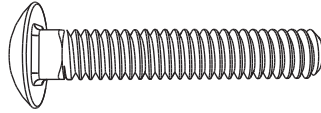

ABU (x2)
1/4" x 1 1/2" Carriage Bolt



ADJ (x2)
1/4" Cap Nut

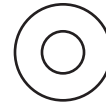

AEE (x3)
#10 Flat Washer

Part shown at 25% of actual size

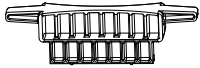

AHM (x2)
Deadbolt Latch

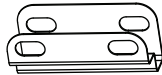

AIB (x1)
Left Door Strike Plate



AIA (x1)
Left Door Lock Bracket

Part shown at 15% of actual size



AHZ (x1)
Left Door Handle

METAL PARTS REQUIRED

METAL PARTS KIT 2 REQUIRED: CAT

Part shown at 8% of actual size

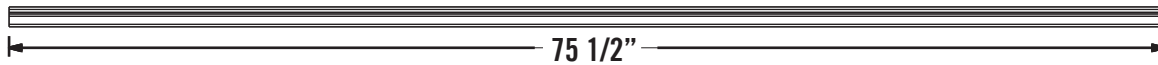

AFC (x1)
Door End Channel

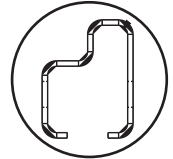

CRD (x1)
Door Hinge Tube

PLASTIC PARTS REQUIRED

LOCATED IN BOX 1

Part shown at 4% of actual size

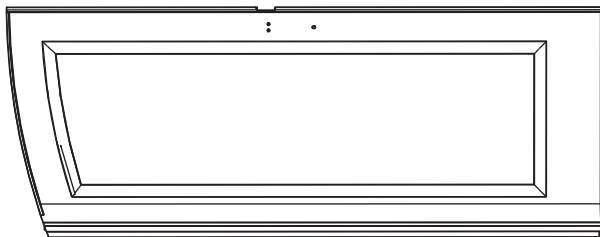

AGO (x1)
Left Door

TOOLS REQUIRED



Phillips Screwdriver



7/16" Wrench

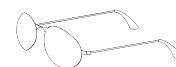

Safety Glasses



TOOLS AND HARDWARE REQUIRED FOR THIS PAGE

SEC 5

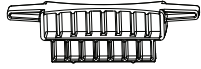

AHM (x2)

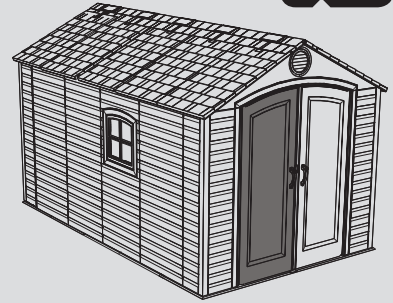

SEC

LEFT DOOR ASSEMBLY

5.1

Rest the **Left Shed Door (AGO)** with front side down. Slide a **Door Hinge Tube (CRD)** through the hole in the Door as shown.

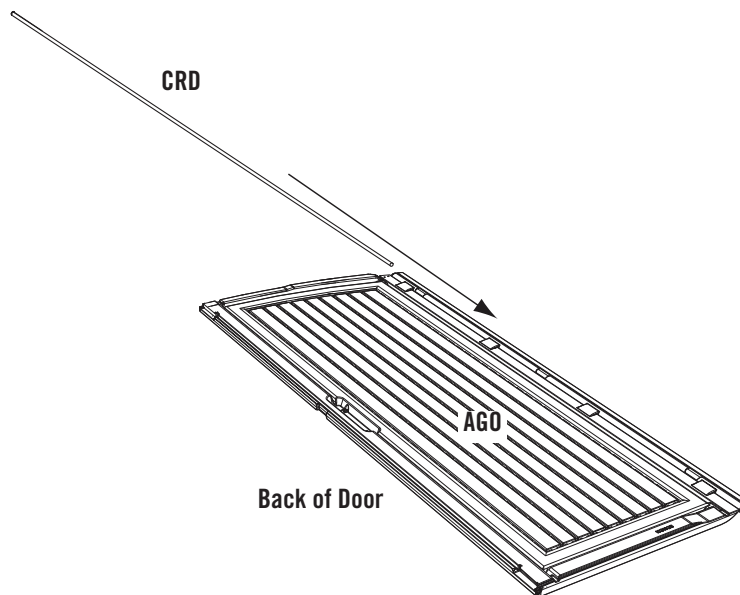

SEC

5.2

Position the **Deadbolt Latches (AHM)** in the slots at the top and bottom of the Door, then slide the **Door End Channel (AFC)** onto the Door as shown.

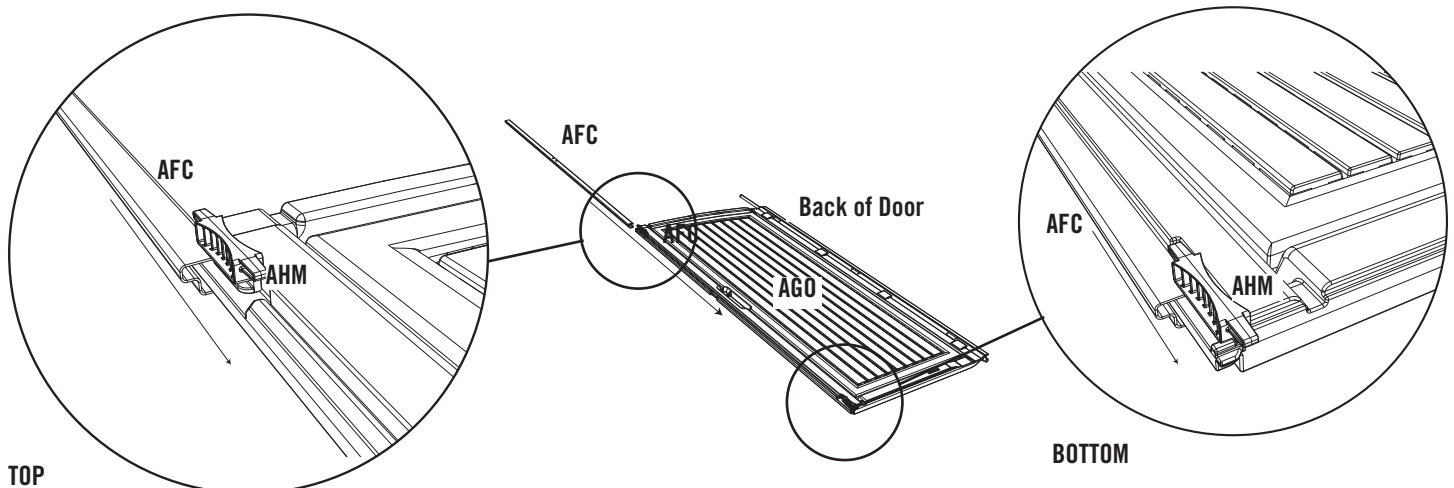

TOP

BOTTOM



Note: The Door End Channel fits onto Door with the flat side up (facing the Deadbolt Latches).



TOOLS AND HARDWARE REQUIRED FOR THIS PAGE

SEC 5



7/16"

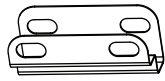

AIB (x1)

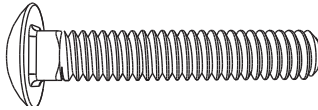

ABU (x2)



ADJ (x2)



AIA (x1)

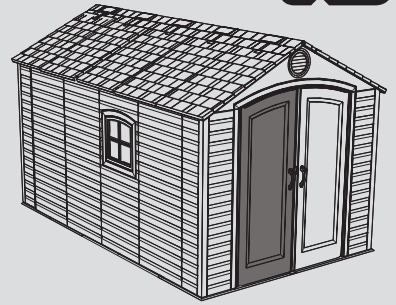

SEC

5.3

Slip the **Left Door Strike Plate (AIB)** over the Left Shed Door and align the holes.

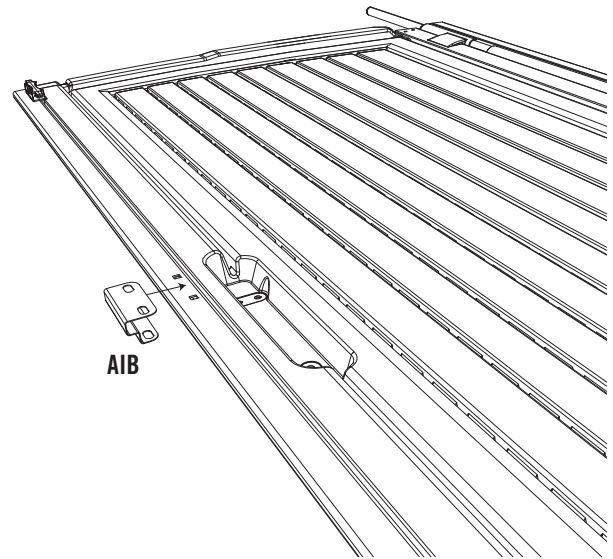

Note: You may need to nudge the Door End Channel to make these holes line up with the gap in the Door.

SEC

5.4

Attach the **Left Door Lock Bracket (AIA)** to the Left Door Strike Plate with two **1/4" x 1 1/2" Carriage Bolts (ABU)** and two **1/4" Cap Nuts (ADJ)**.

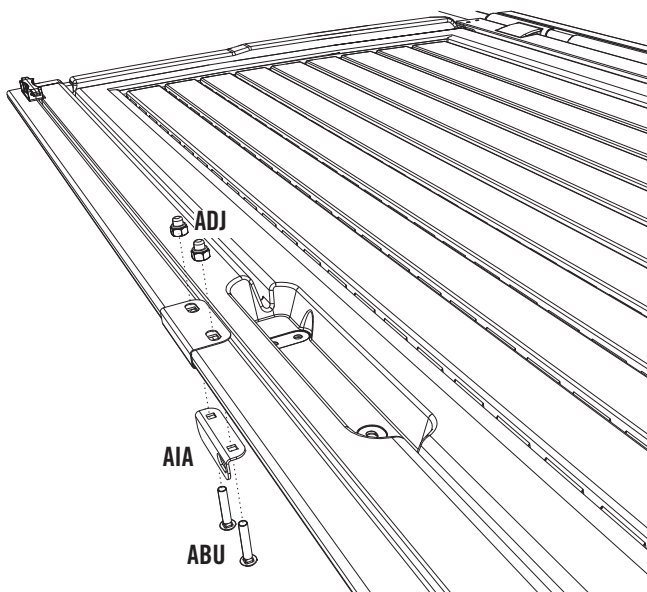

WARNING

Do not overtighten the Cap Nut. If the end of the Bolt breaks through the plastic cap, call our Customer Service Department. Exposed threads on the end of the Bolt may cause serious injuries.



TOOLS AND HARDWARE REQUIRED FOR THIS PAGE

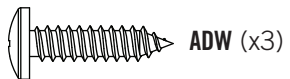
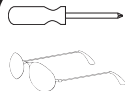

SEC 5

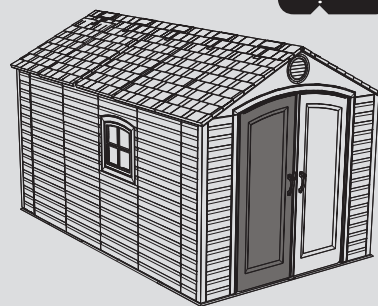

SEC

5.5

Attach the **Left Door Handle (AHZ)** using three (3) **#10 Flat Washers (AEE)** and three (3) **#10 x 3/4" Pan-Head Screws (ADW)**.

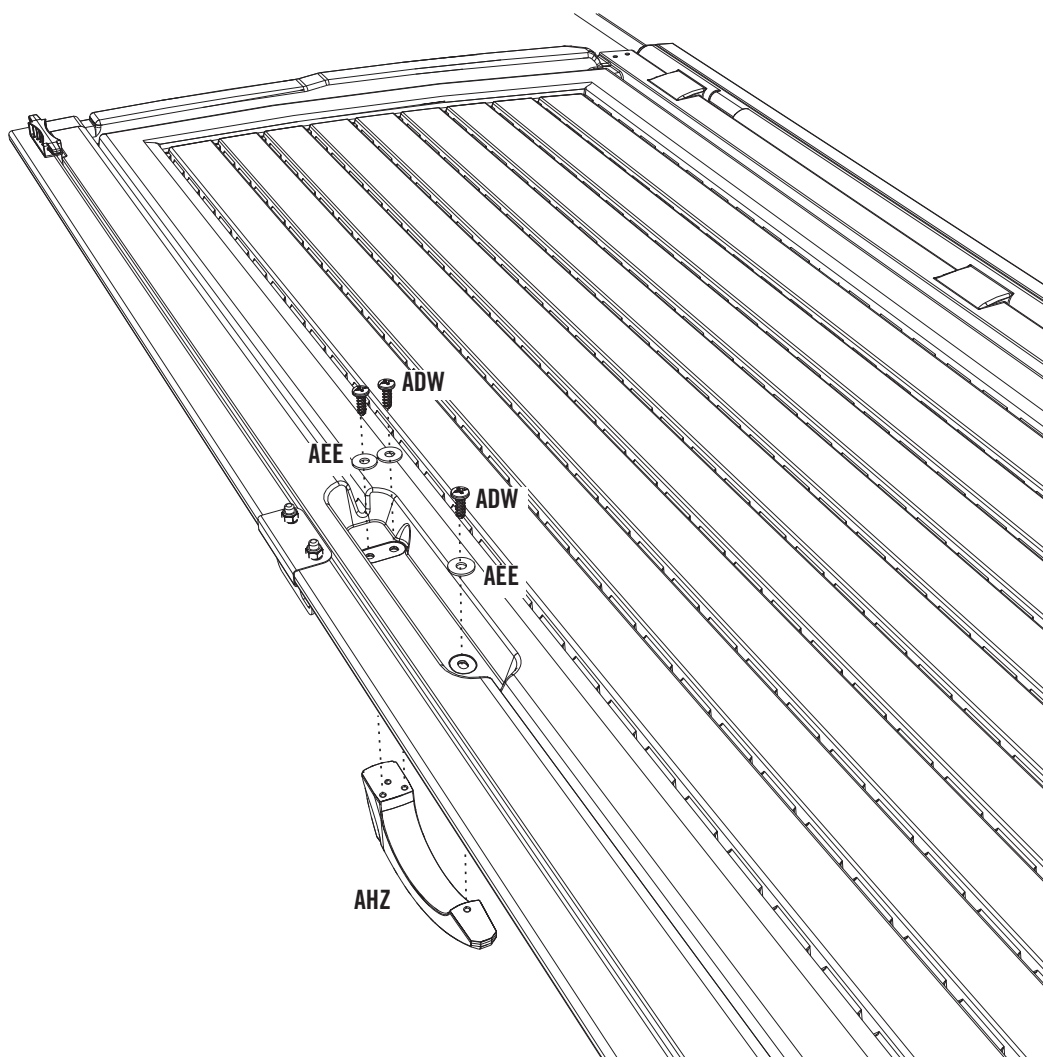

SEC 6 RIGHT DOOR ASSEMBLY

HARDWARE REQUIRED

HARDWARE BAG REQUIRED: BEG

Hardware shown at actual size

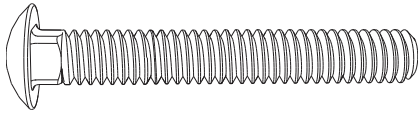

ABV (x2)
1/4" x 2" Carriage Bolt

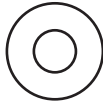

AEE (x5)
#10 Flat Washer
(Only 3 are used)

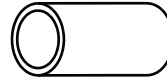

ADB (x2)
3/8" x 1/2" Steel Spacer

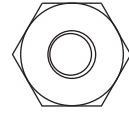

AAB (x2)
1/4" Centerlock Nut

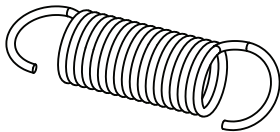

AHY (x1)
Latch Spring

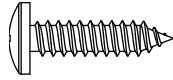

ADW (x4)
#10 x 3/4" Pan-Head Screw

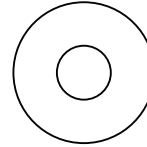

AEB (x2)
1/4" Flat Washer

Part shown at 25% of actual size

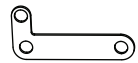

AHX (x1)
Latch Cover Plate

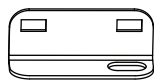

AIL (x1)
Right Door Lock Bracket

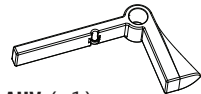

AHV (x1)
Door Latch

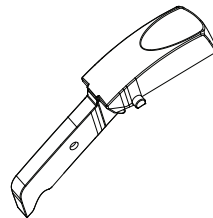

AIO (x1)
Thumb Lever

Part shown at 15% of actual size

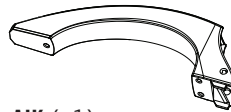

AIK (x1)
Right Door Handle

Part shown at 50% of actual size

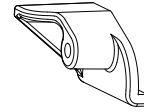

AHW (x1)
Latch Block

METAL PARTS REQUIRED

METAL PARTS KIT 2 REQUIRED: CAT

Part shown at 8% of actual size

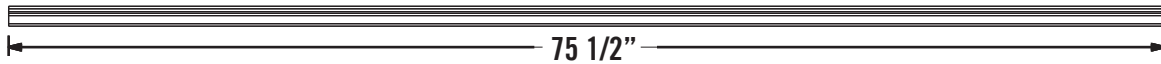

AFC (x1)
Door End Channel

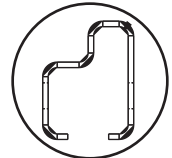

CRD (x1)
Door Hinge Tube

PLASTIC PARTS REQUIRED

LOCATED IN BOX 1

Part shown at 4% of actual size

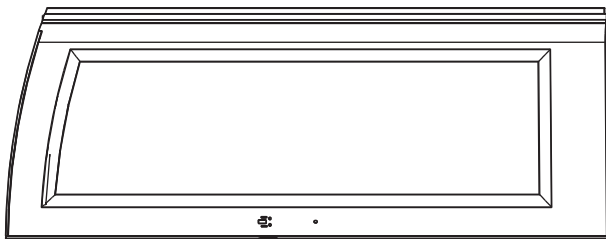

AGZ (x1)
Right Door

TOOLS REQUIRED

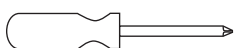

Phillips Screwdriver



7/16" Wrench

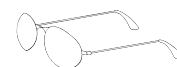

Safety Glasses



TOOLS AND HARDWARE REQUIRED FOR THIS PAGE

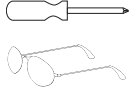

NO HARDWARE REQUIRED FOR THIS PAGE

SEC 6

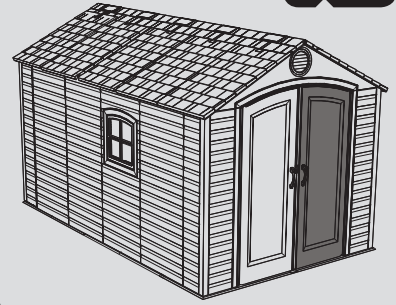

SEC

RIGHT DOOR ASSEMBLY

6.1

Rest the **Right Shed Door (AGZ)** with front side down. Slide a **Door Hinge Tube (CRD)** through the hole in the Door as shown.

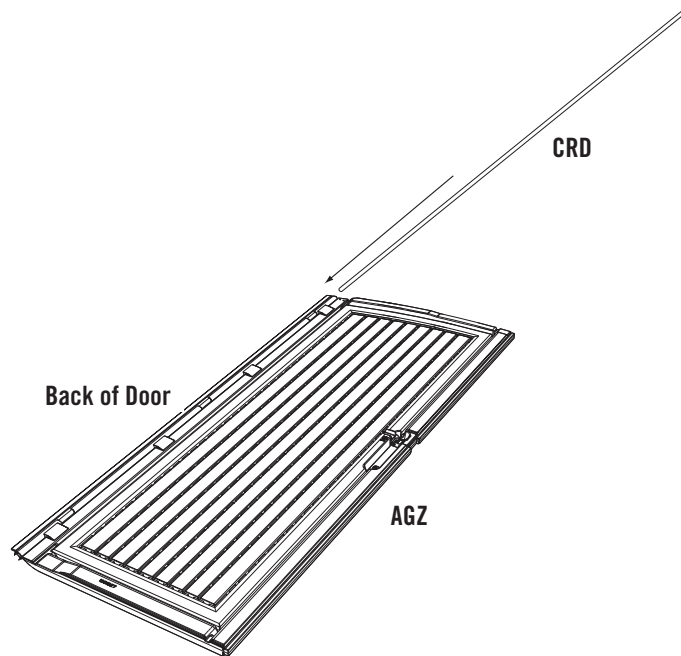

SEC

6.2

Slide the **Door End Channel (AFC)** onto the Door as shown.

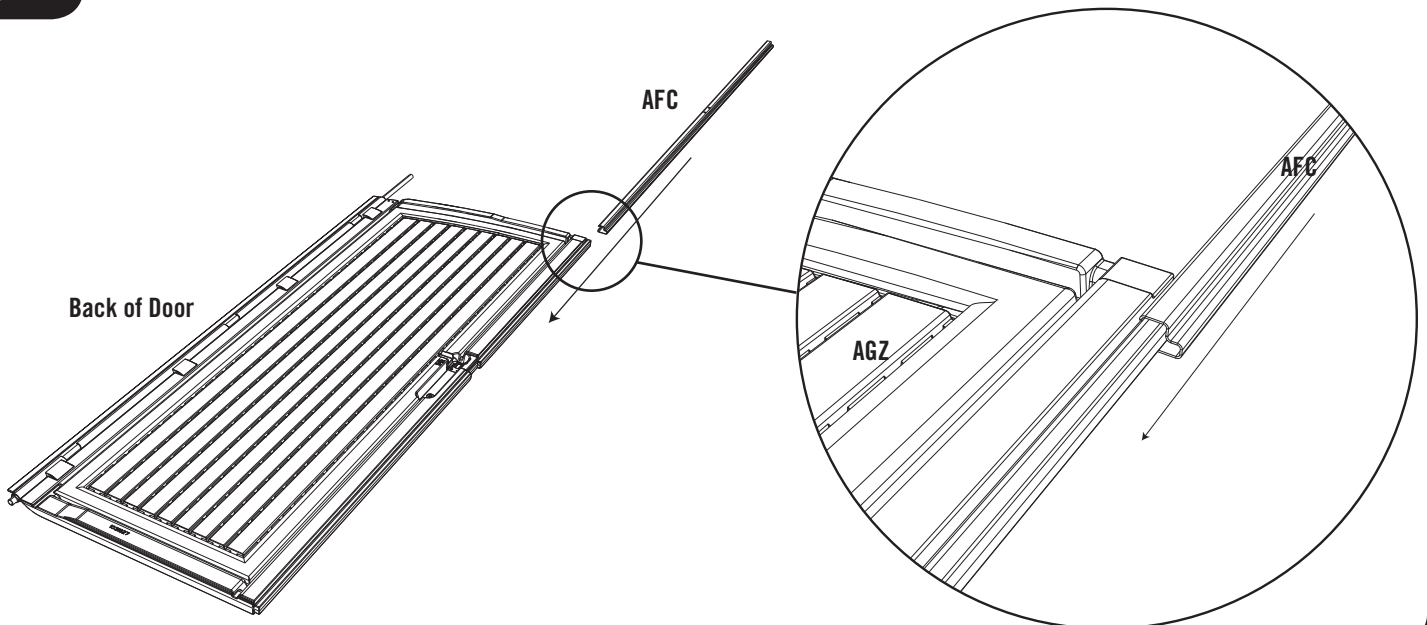



TOOLS AND HARDWARE REQUIRED FOR THIS PAGE



NO HARDWARE REQUIRED FOR THIS PAGE

SEC 6

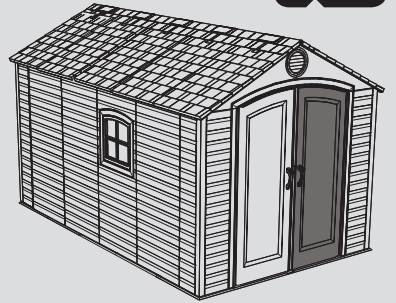

SEC

6.3

Fit knobs of **Thumb Lever (A10)** into the grooves of **Right Door Handle (A1K)**.

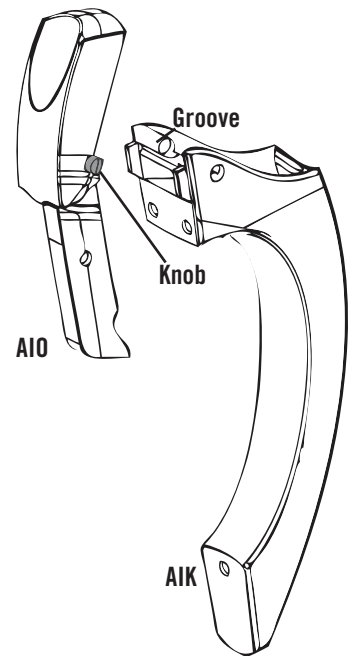

SEC

6.4

Rotate the Thumb Lever into the Right Door Handle. Slide forward until the knobs fit into the holes in the Handle.

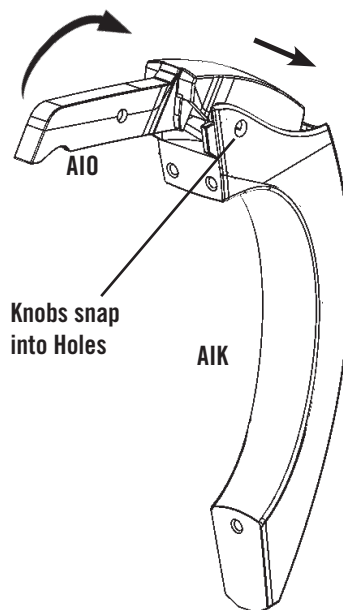



TOOLS AND HARDWARE REQUIRED FOR THIS PAGE

SEC 6

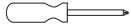

7/16"

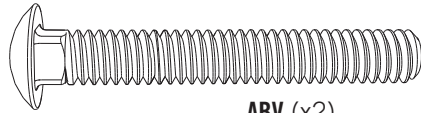

ABV (x2)

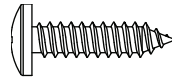

ADW (x3)

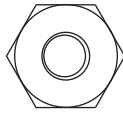

AAB (x2)

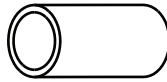

ADB (x2)

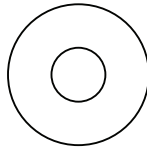

AEB (x2)

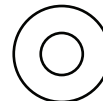

AEE (x3)

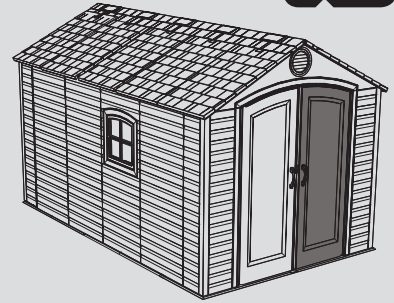

SEC

6.5

Attach the Right Handle Assembly to the Door using three (3) #10 Flat Washers (AEE) and three (3) #10 x 3/4" Pan-Head Screws (ADW).

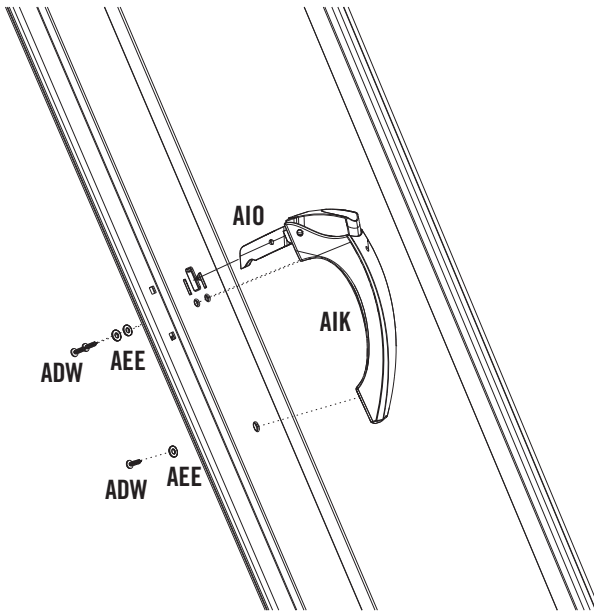

CAUTION

Do not overtighten. Overtightening may damage parts and void warranty.

SEC

6.6

Install Handle Latch assembly onto the Right Shed Door using the required hardware.

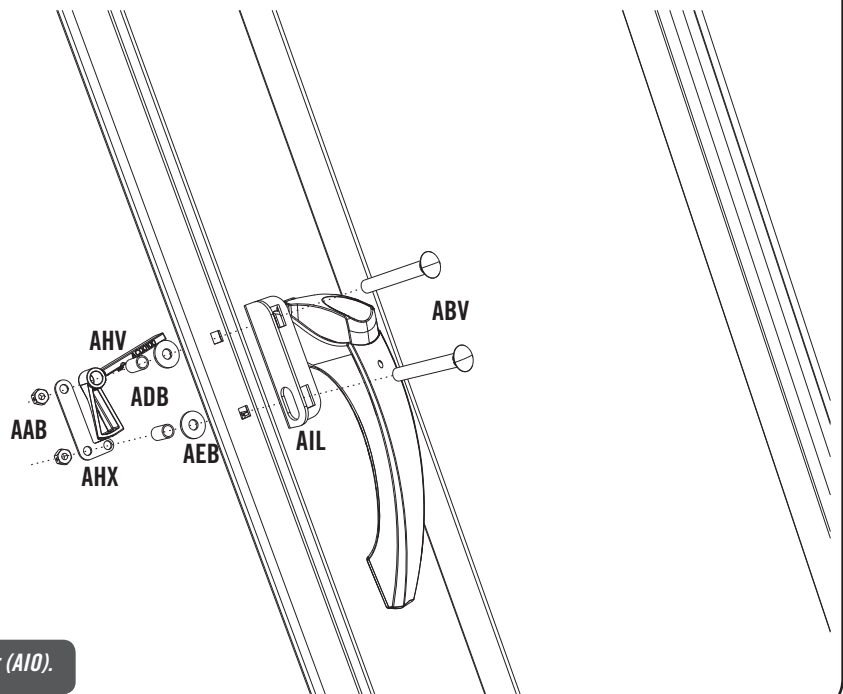
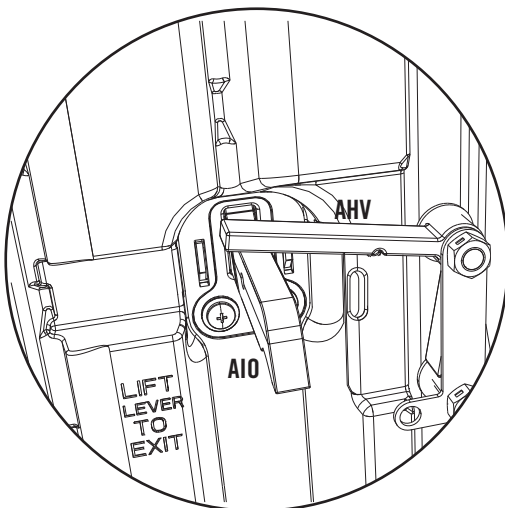

Note: The Door Latch (AHV) goes on top of the Thumb Lever (AIO).



TOOLS AND HARDWARE REQUIRED FOR THIS PAGE

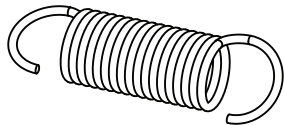
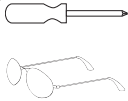

AHY (x1)

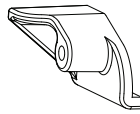

AHW (x1)

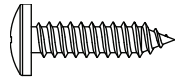

ADW (x1)

SEC 6

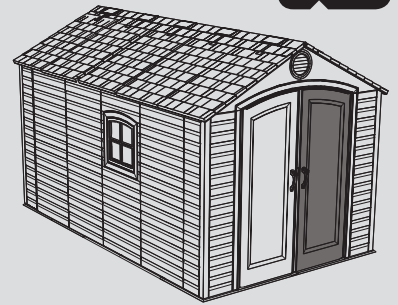

SEC

6.7

Line up the hole in the **Latch Block (AHW)** with the hole in the Thumb Lever and secure with one (1) **#10 X 3/4" Pan-Head Screw (ADW)**.

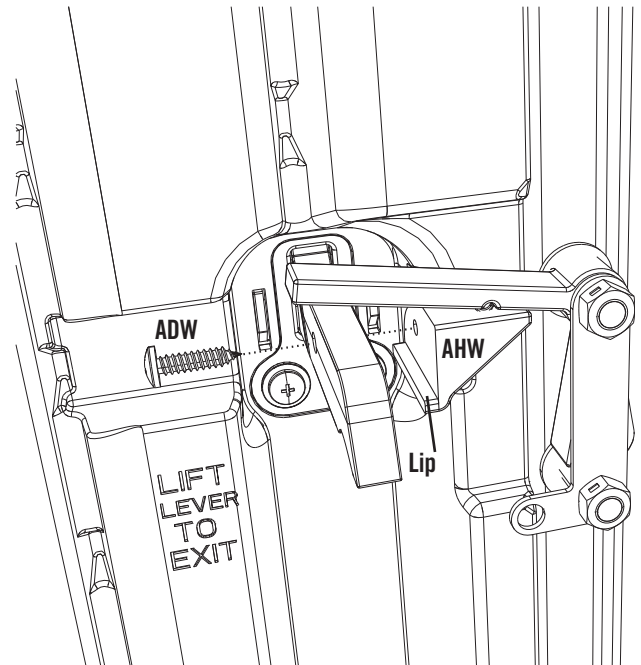

Note: The lip of the Latch Block (AHW) fits under the Thumb Lever (A10).

SEC

6.8

Attach **Latch Spring (AHY)** to the **Door Latch (AHV)** and the **Latch Cover Plate (AHX)**. Set the Door aside.

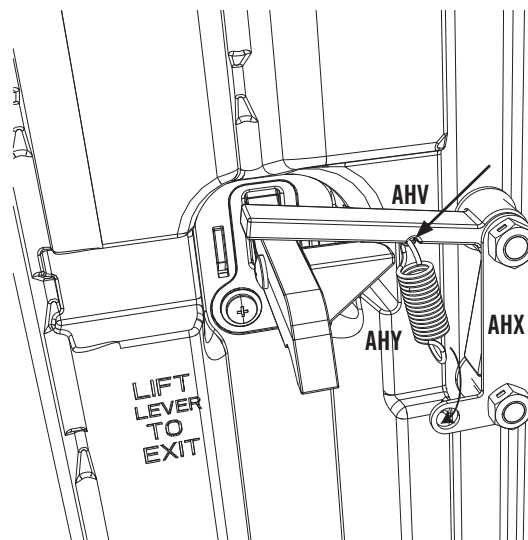

Note: Use pliers to pull spring down and hook into bottom hole.



WARNING



When pulling on spring, each person should use protective eye glasses to help prevent serious eye injury.

SEC 7 GABLE ASSEMBLY

HARDWARE REQUIRED

HARDWARE BAG REQUIRED: BHV (x2)

Hardware shown at actual size

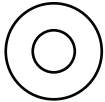

AEE (x10)
#10 x 1/2" Flat Washer

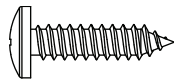

ADW (x10)
#10 x 3/4" Pan-Head Screw

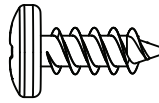

ADZ (x8)
1/4" x 5/8" Pan-Head Screw
(Only 4 used)

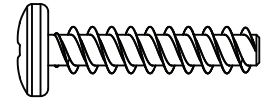

ADV (x12)
1/4" x 1 1/8" Pan-Head Screw
(Only 6 used)



AHS (x4)
End Plug
(Only 2 used)

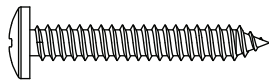

ACB (x2)
#10 x 1 1/4" Pan-Head Screw
(Not used in this model)

Parts shown at 8% of actual size

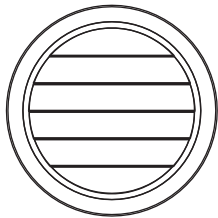

AGP (x2)
Louvered Vent

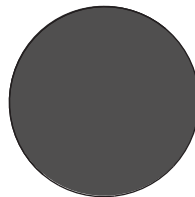

AIQ (x2)
Vent Screen

METAL PARTS REQUIRED

SMALL PARTS KIT REQUIRED: CAT

Part shown at 8% of actual size

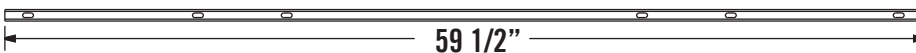

AFE (x1)
Entry Header Bar

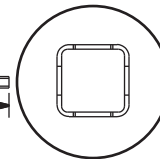

PLASTIC PARTS REQUIRED

LOCATED IN BOX 1

Parts shown at 4% of actual size

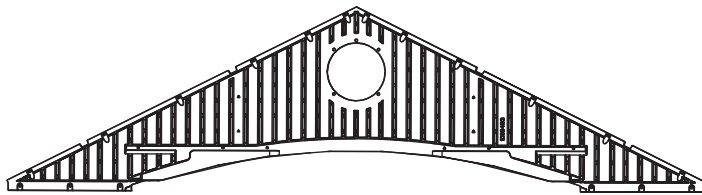

AGF (x1)
Entry Gable

(Rear View)

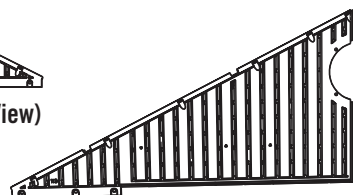

AGH (x1)
Rear Gable 1

(Rear View)

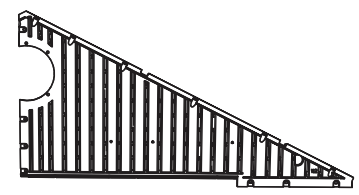

AGI (x1)
Rear Gable 2

(Rear View)

TOOLS REQUIRED



Phillips Screwdriver

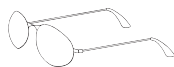

Safety Glasses



TOOLS AND HARDWARE REQUIRED FOR THIS PAGE

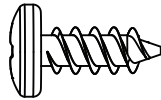
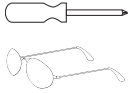

ADZ (x4)

SEC 7

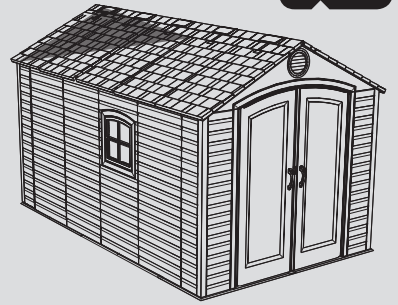

SEC

REAR GABLE ASSEMBLY

7.1

Lay the edge of **Rear Gable 2 (AGI)** over **Rear Gable 1 (AGH)** as shown, and align the four holes.

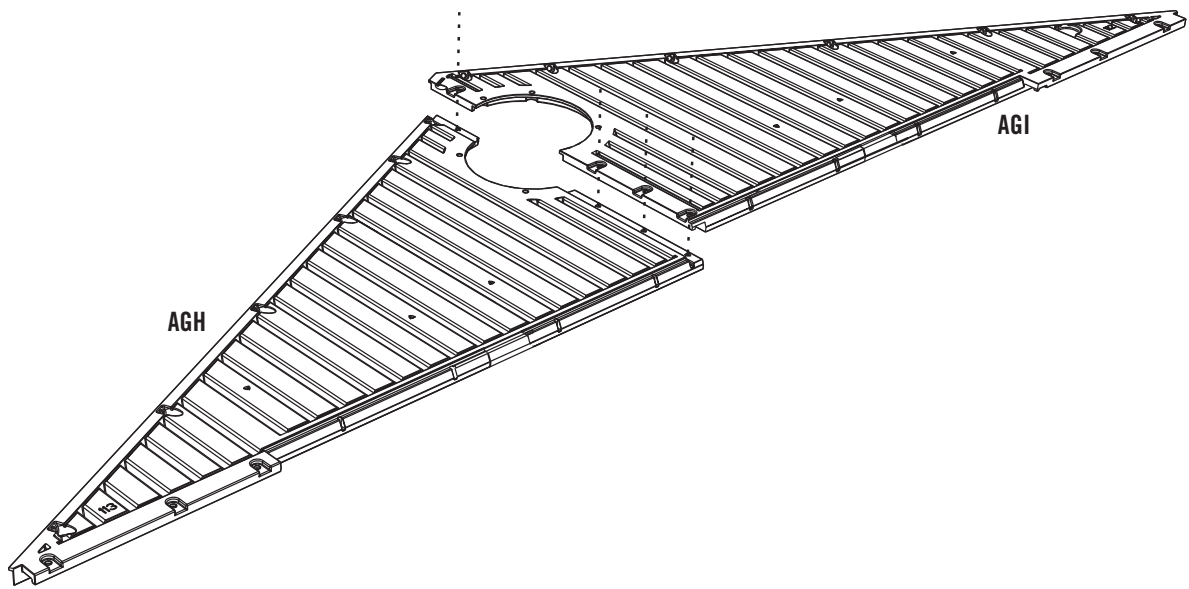

SEC

7.2

Connect Rear Gables 1 & 2 together using four (4) **1/4" x 5/8" Pan-Head Screws (ADZ)** as shown.

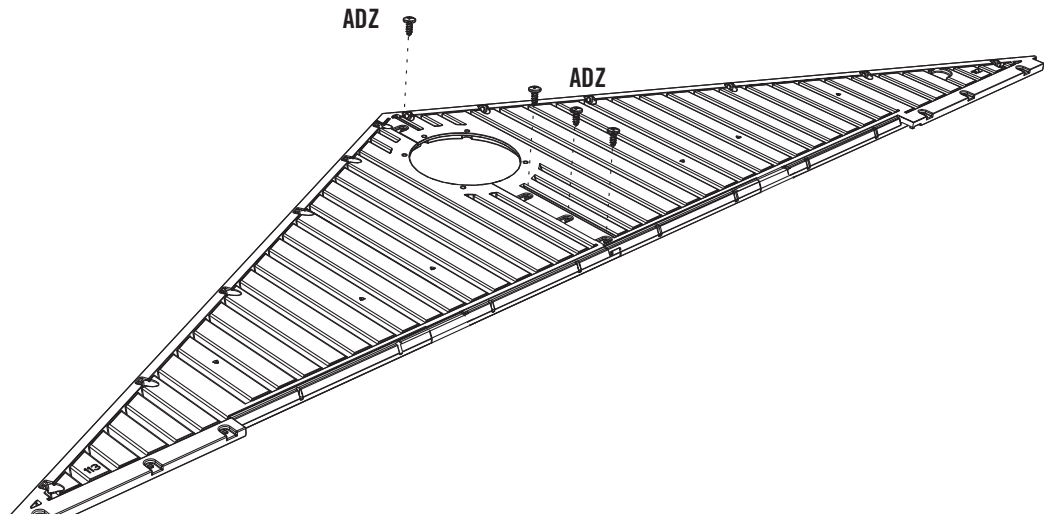

Note: Only use a hand screwdriver in this step.



TOOLS AND HARDWARE REQUIRED FOR THIS PAGE

SEC 7

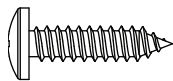
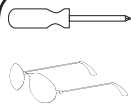

ADW (x5)

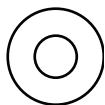

AEE (x5)

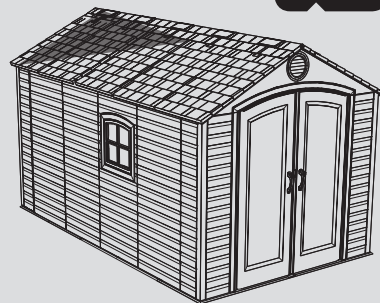

SEC

7.3

Lay Rear Gable Assembly flat on the ground over the **Vent Screen (AIQ)** and **Louvered Vent (AGP)**. Align the holes in the Louvered Vent with those in the Rear Gable Assembly.

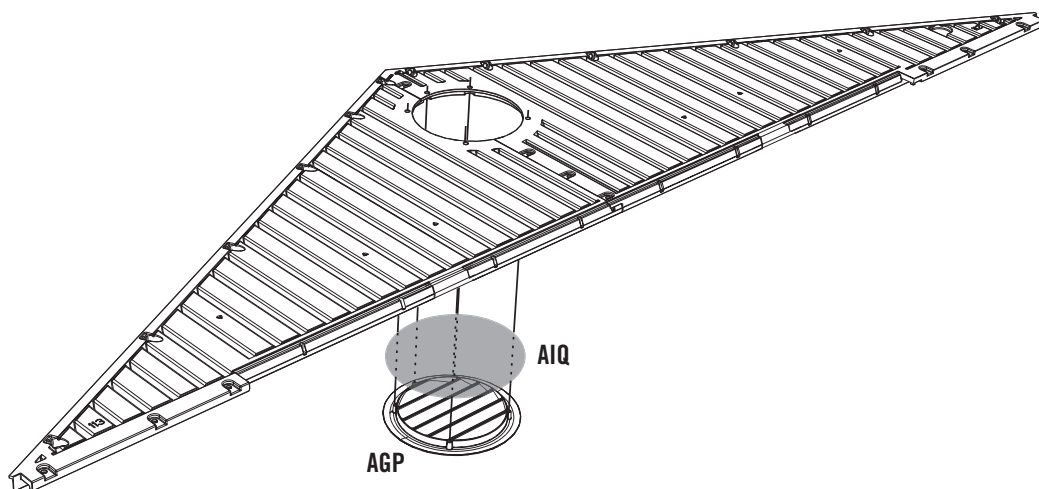

SEC

7.4

After aligning the holes, press down firmly on the Rear Gable Assembly while inserting the five (5) **#10 x 3/4" Pan-Head Screws (ADW)** and the five (5) **#10 x 1/2" Flat Washers (AEE)**. Pressing down firmly while inserting the Screws will help prevent the Vent Screen from twisting. Set aside.

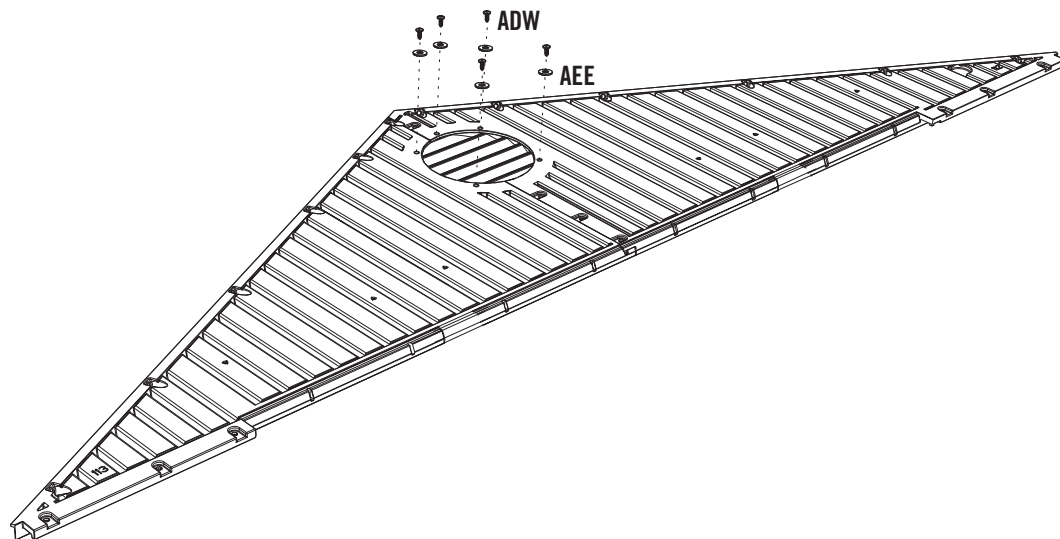

Note: Only use a hand screwdriver in this step.



TOOLS AND HARDWARE REQUIRED FOR THIS PAGE

SEC 7

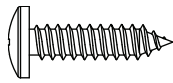
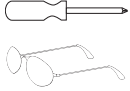

ADW (x5)

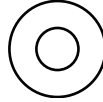

AEE (x5)

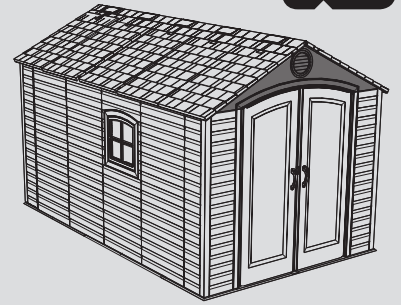

SEC

ENTRY GABLE ASSEMBLY

7.5

Lay **Entry Gable (AGF)** flat on the ground over the **Vent Screen (AIQ)** and **Louvered Vent (AGP)** as shown. Align the holes in the Louvered Vent with those in the Entry Gable.

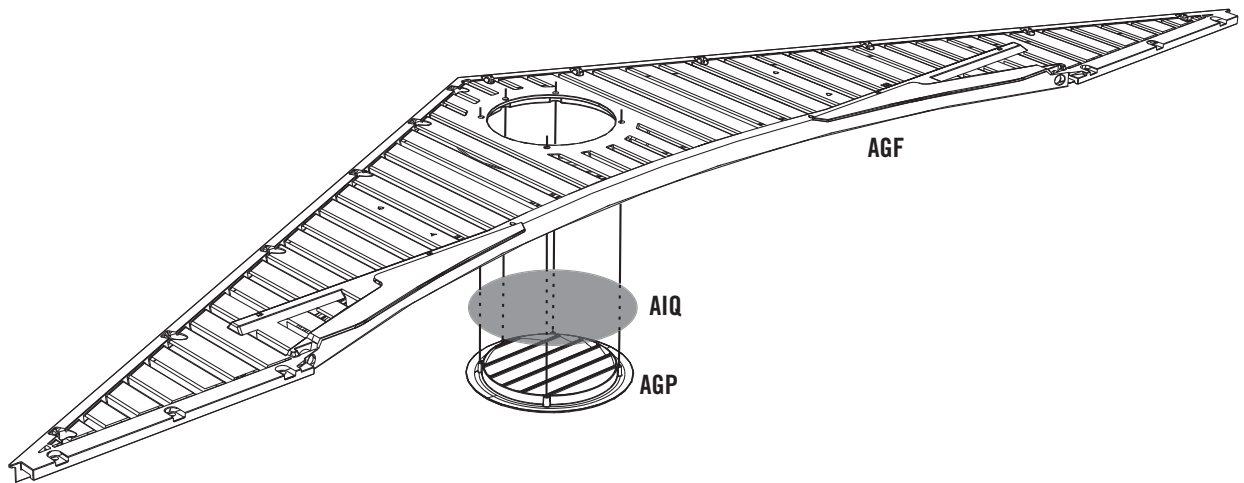

SEC

7.6

After aligning the holes, press down firmly on the Entry Gable when inserting the five (5) **#10 x 3/4" Pan-Head Screws (ADW)** and the five (5) **#10 x 1/2" Flat Washers (AEE)**. Pressing down firmly while inserting the Screws will help prevent the Vent Screen from twisting.

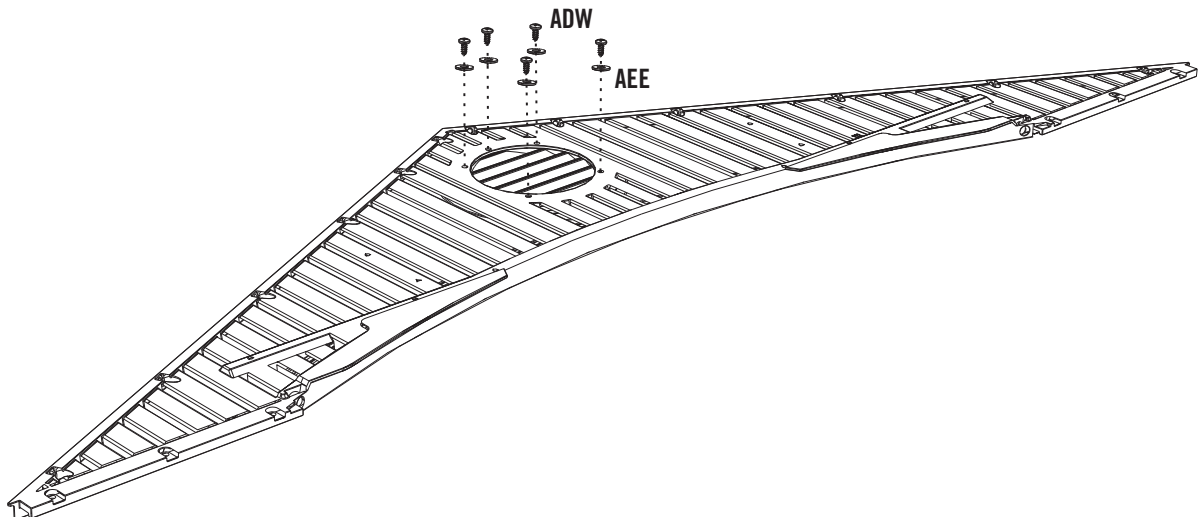

Note: Only use a hand screwdriver in this step.



TOOLS AND HARDWARE REQUIRED FOR THIS PAGE

SEC 7

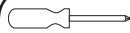

AHS (x2)



ADV (x6)

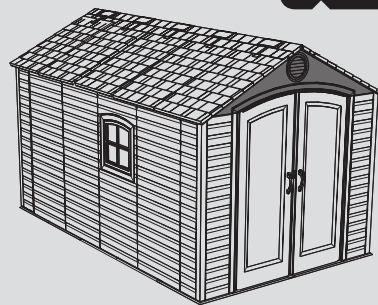

SEC

7.7

Insert an **End Plug (AHS)** into each end of **Entry Header Bar (AFE)**.

The flat screw holes should face away from the Entry Gable.

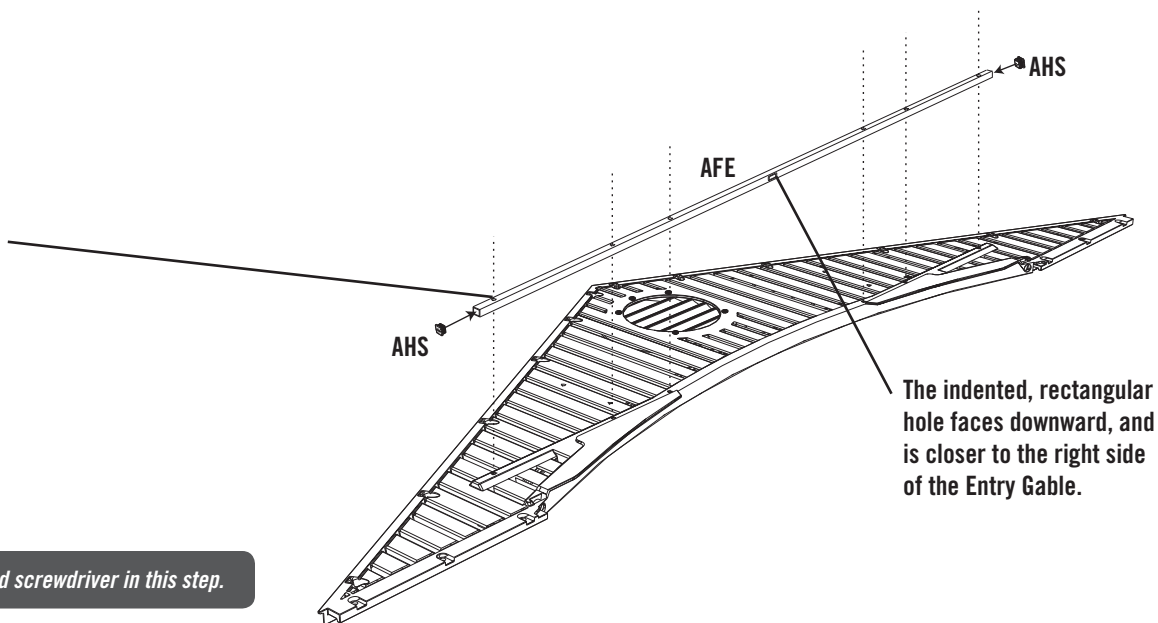

The indented, rectangular hole faces downward, and is closer to the right side of the Entry Gable.



Note: Only use a hand screwdriver in this step.

SEC

7.8

Attach the Entry Header Bar to the Entry Gable Assembly, and secure with six (6) **1/4" x 1/8" Pan-Head Screws (ADV)**. Set aside.

The flat screw holes should face away from the Entry Gable.

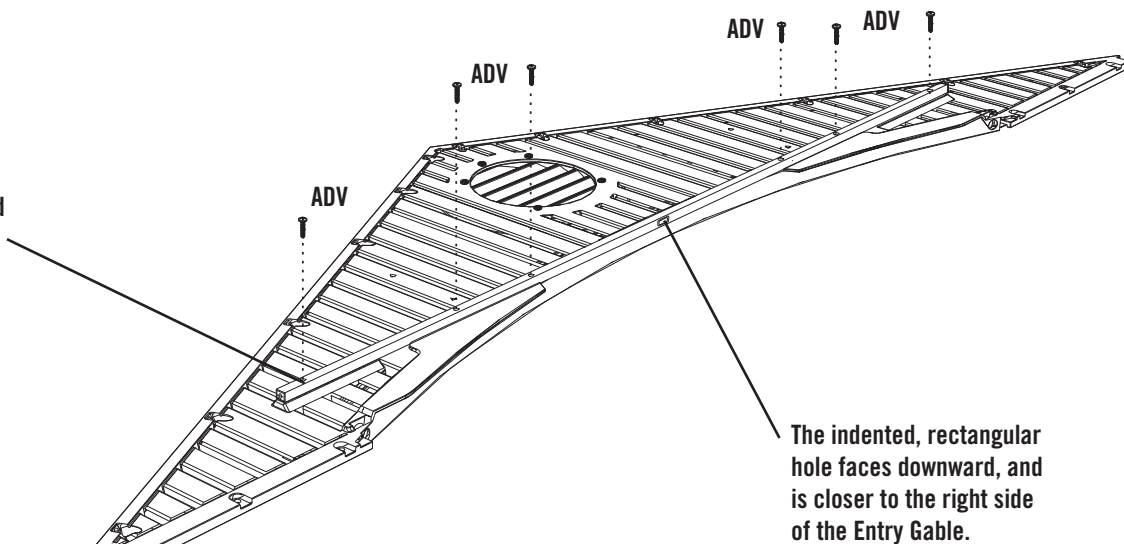

The indented, rectangular hole faces downward, and is closer to the right side of the Entry Gable.



Note: Only use a hand screwdriver in this step.

SEC 8 DOOR & ENTRY GABLE INSTALLATION

HARDWARE REQUIRED

HARDWARE BAG REQUIRED: BHZ

Hardware shown at actual size (*Unless noted otherwise)

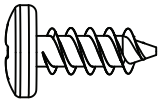

ADZ (x6)
1/4" x 5/8" Pan-Head Screw



AHP (x2)
Cotter Pin

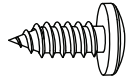

ADX (x4)
#10 x 1/2" Pan-Head Screw

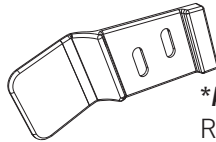

***AIM (x1)**
Right Gap Flap

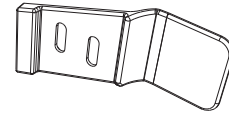

***AIC (x1)**
Left Gap Flap

PLASTIC PARTS REQUIRED

Parts shown at 4% of actual size

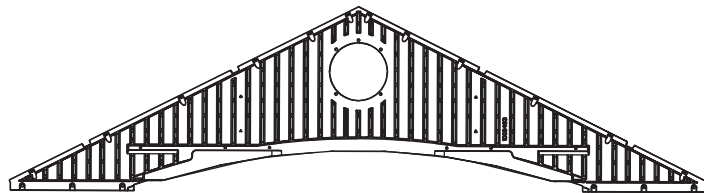

Entry Gable Assembly **Rear View**

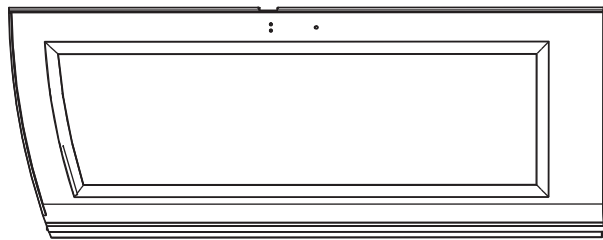

Left Door Assembly

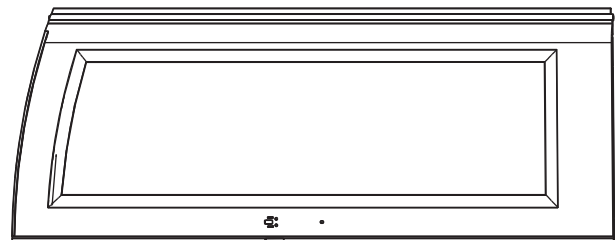

Right Door Assembly

TOOLS REQUIRED

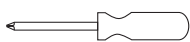

Phillips Screwdriver

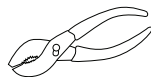

Pliers



Safety Glasses



TOOLS AND HARDWARE REQUIRED FOR THIS PAGE

SEC 8



AHP (x2)

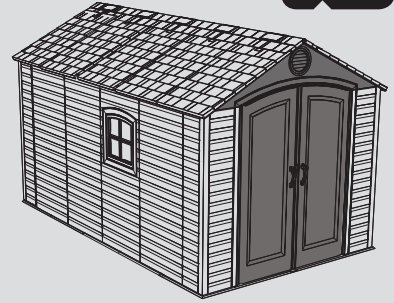

SEC

DOOR INSTALLATION

8.1

Align the hole in the bottom of the Hinge of the **Left Door Assembly** with the hole in the Door Hinge Bushing on the Floor of your shed, and insert the Door Hinge Tube into the Door Hinge Bushing.

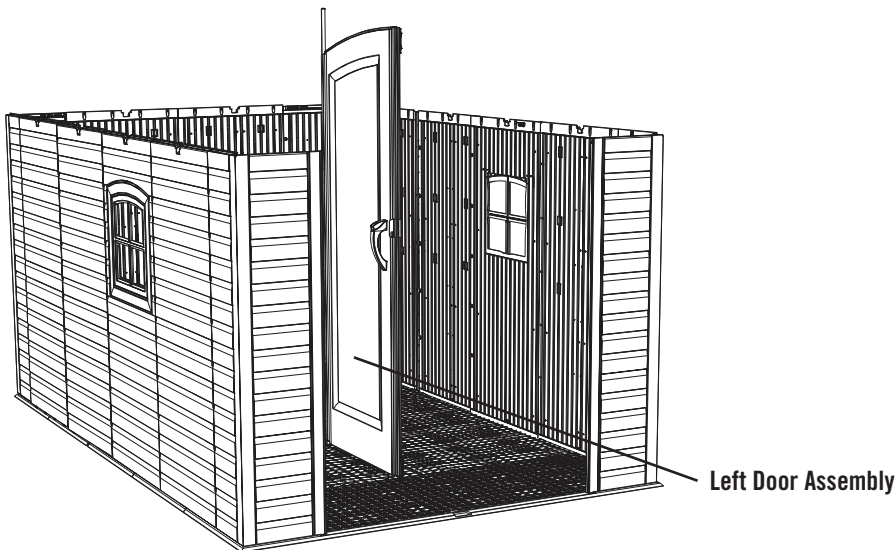

SEC

8.2

Insert a **Cotter Pin (AHP)** through the Bushing and Door Hinge. Use a pair of pliers to bend the ends of the Cotter Pins outward. **Repeat these steps for the Right Door Assembly.**

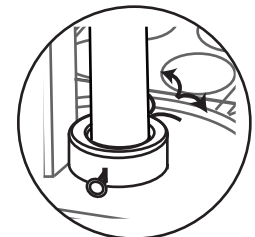
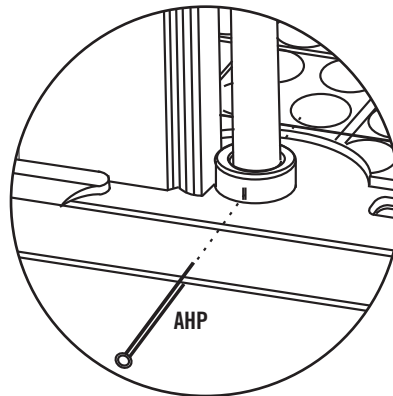
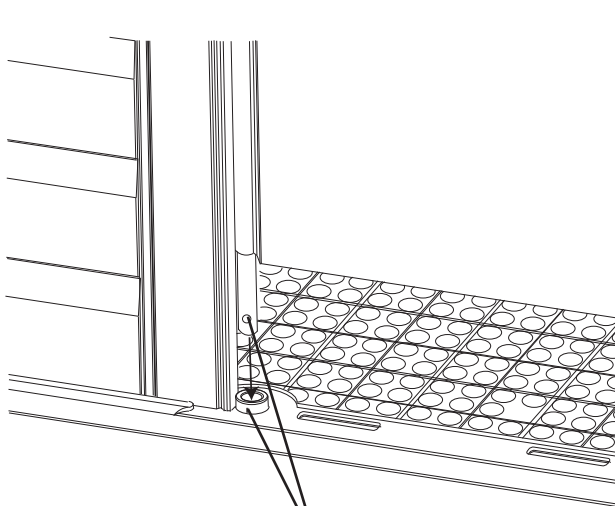

! Note: Use pliers to bend back the ends of the Cotter Pin (AHP).

! Note: Ensure that these two holes line up, so that the Cotter Pin (AHP) can be inserted.



TOOLS AND HARDWARE REQUIRED FOR THIS PAGE

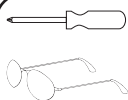

SEC 8

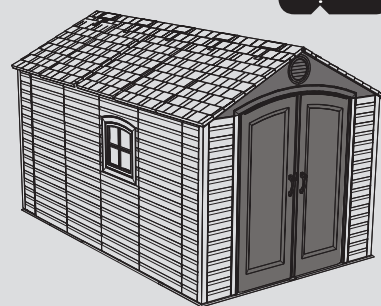

2 ADULTS REQUIRED FOR THE STEPS ON THIS PAGE

SEC

ENTRY GABLE INSTALLATION

8.3

Slide the two holes in the **Entry Gable Assembly** down over the Door Hinge Tubes as shown.

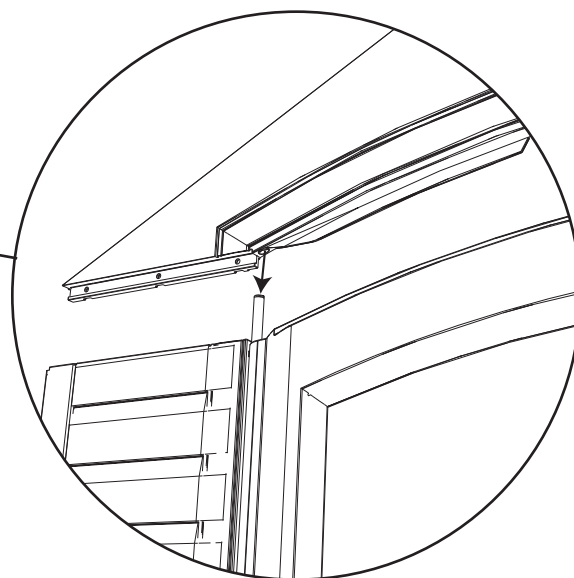
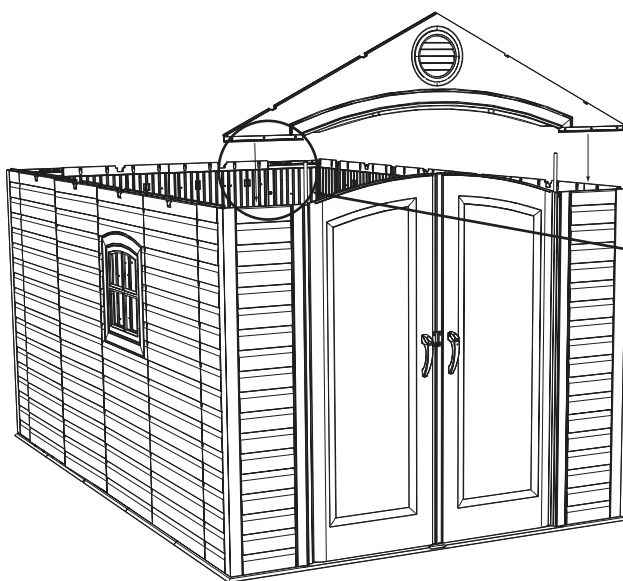

SEC

8.4

Align the holes in the sides of the Entry Gable Assembly with those in the tops of the Corner Wall Panels and secure with six (6) **1/4" x 5/8" Pan Head Screws (ADZ)** at the locations indicated.

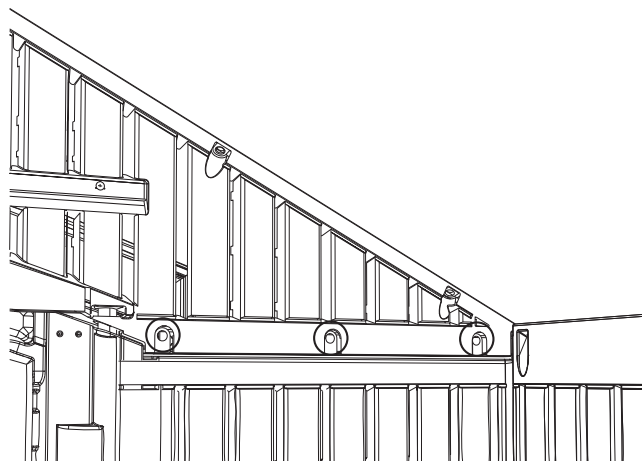
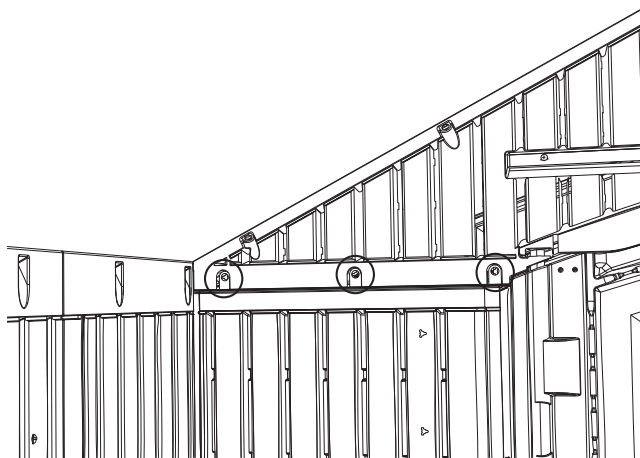



TOOLS AND HARDWARE REQUIRED FOR THIS PAGE

SEC 8

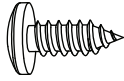
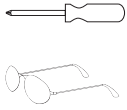

ADX (x4)

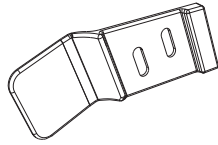

AIM (x1)
(Not to scale)

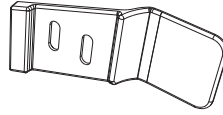

AIC (x1)
(Not to scale)

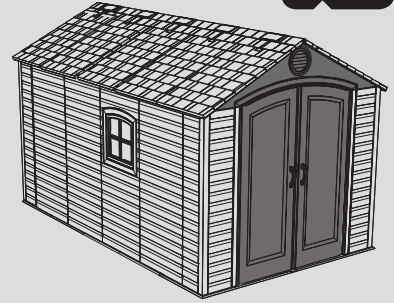

SEC

GAP FLAP INSTALLATION

8.5

Attach the **Right & Left Gap Flaps (AIM & AIC)** to the top, right and left corners of the Doors as shown. Before completely tightening the **#10 x 1/2" Pan-Head Screws (ADX)**, slide the Gap Flaps up until they cover any gap between the tops of the Doors and the Gable.

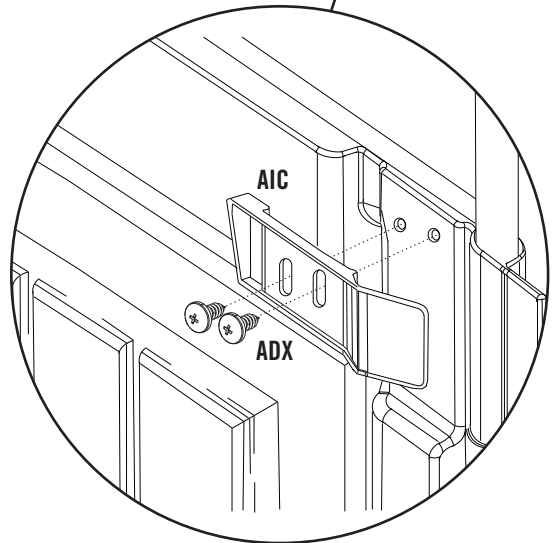
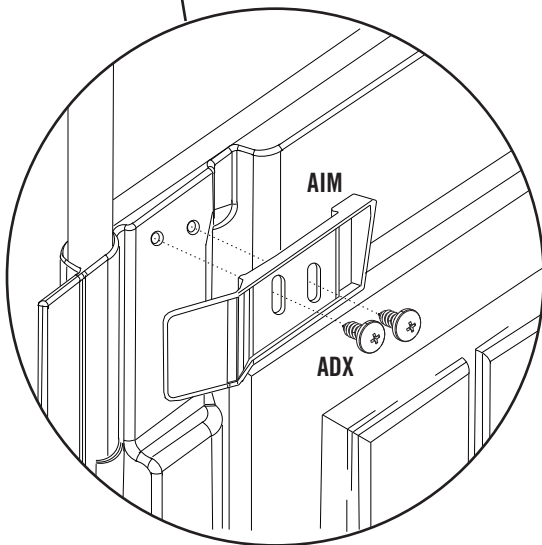
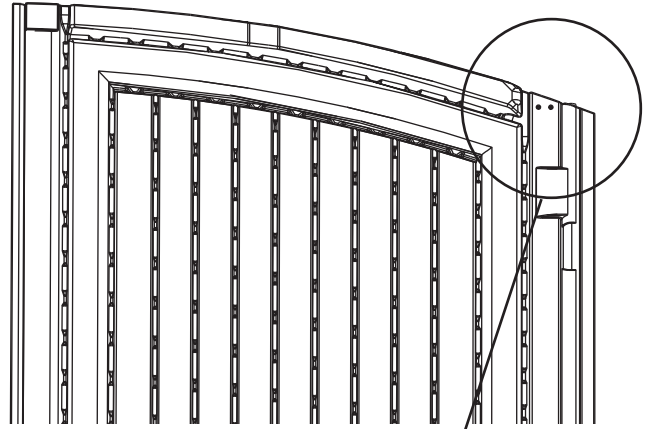
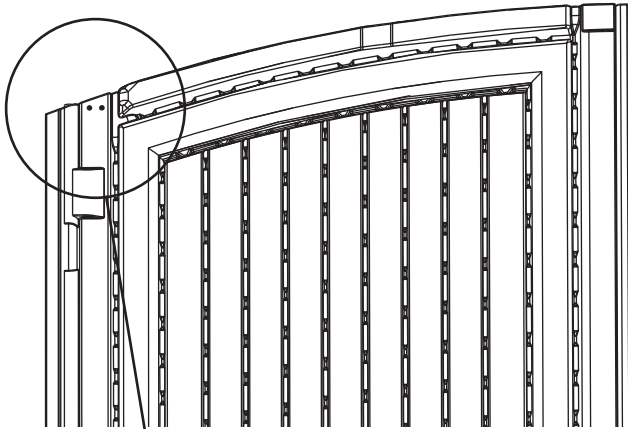

SEC 9 TRUSS, REAR GABLE, & ROOF INSTALLATION

HARDWARE REQUIRED

HARDWARE BAG REQUIRED: CAO

Hardware shown at actual size (*Unless otherwise noted)

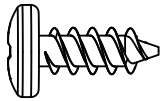

ADZ (x152)
1/4" x 5/8" Pan-Head Screw
(Not all screws will be used)

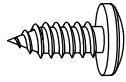

ADX (x30)
#10 x 1/2" Pan-Head Screw

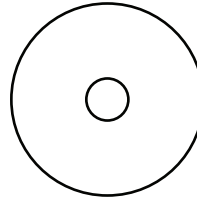

AED (x30)
#10 x 1" Fender Washer

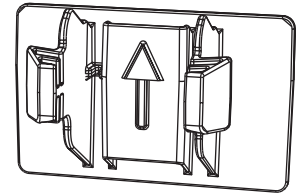

AXX (x2)
Truss Hole Insert

METAL PARTS REQUIRED

SMALL PARTS KIT REQUIRED: CAQ

Parts shown at 8% of actual size



AFL (x10)
Roof Support Strip

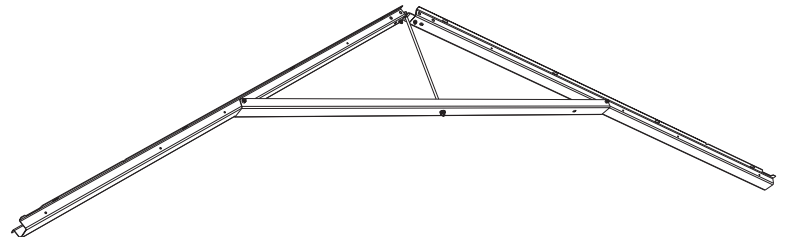

Truss Assembly (x4)



Note: The hole in the Roof Support Strip is for manufacturing purposes only.

PLASTIC PARTS REQUIRED

LOCATED BOX 1 & SMALL PARTS KIT: CAQ

Parts shown at 4% of actual size

Parts shown at 8% of actual size

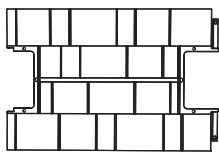

AFY (x4)
Center Roof Cap

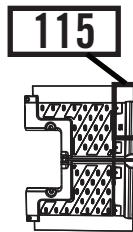

AGG (x1)
Front Roof Cap

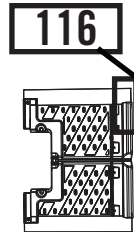

AFW (x1)
Rear Roof Cap

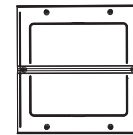

AHC (x5) Skylight

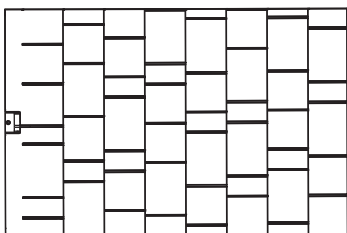

***AGQ** (x10) Roof Panel

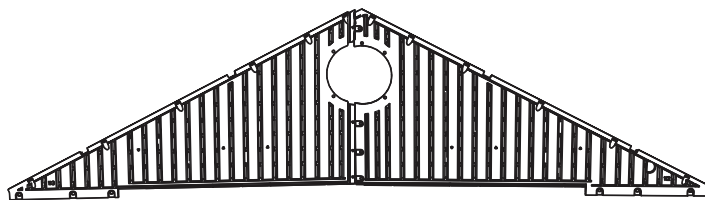

Rear Gable Assembly

TOOLS REQUIRED



Phillips Screwdriver

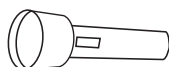

Flashlight

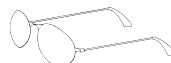

Safety Glasses



TOOLS AND HARDWARE REQUIRED FOR THIS PAGE

SEC 9

NO HARDWARE REQUIRED FOR THIS STEP

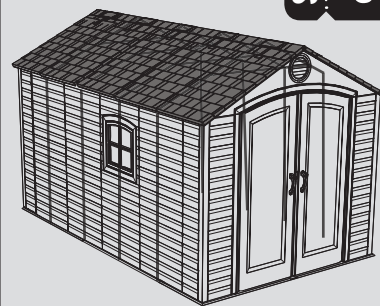

3 ADULTS REQUIRED FOR STEPS 9.1 - 9.7

SEC

9.1

TRUSS & ROOF INSTALLATION

Place the ends of a **Truss Assembly** into the notches on the Wall Panels as shown. While one adult holds the Truss Assembly in place, set a **Roof Panel (AGQ)** onto the Truss Assembly and Entry Gable. The edge of the Roof Panel fits down inside the Truss Channel. The opposite edge hangs over the Entry Gable.

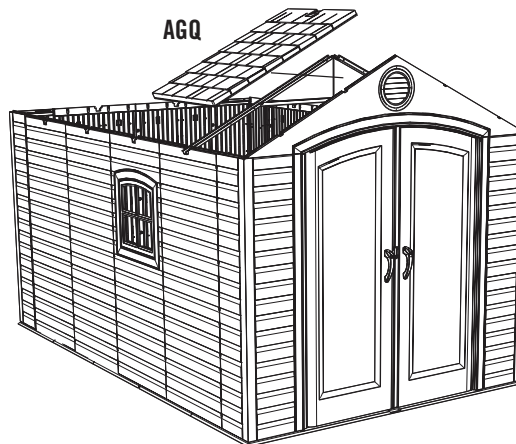
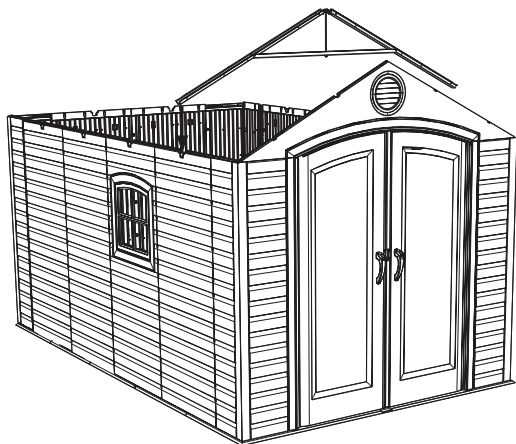

! *Note: Ensure to carefully read and follow the roof installation instructions and notes. Following each step in the order listed will minimize potential complications during installation.*

SEC

9.2

Ensure the alignment nub in the Roof Panel fits into the notch on the Truss (this helps to align the holes in the Roof Panel with those in the Truss, the Wall Panel, and Gable).

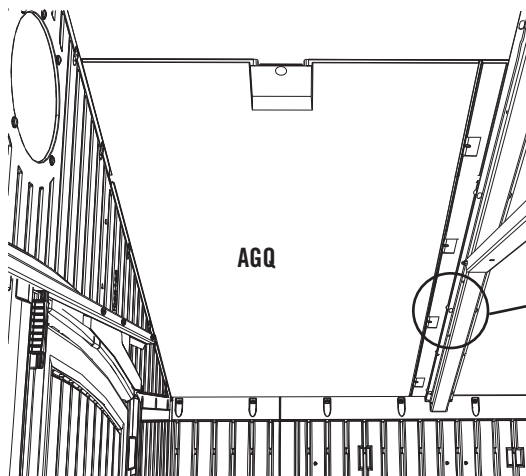

Interior Upward View

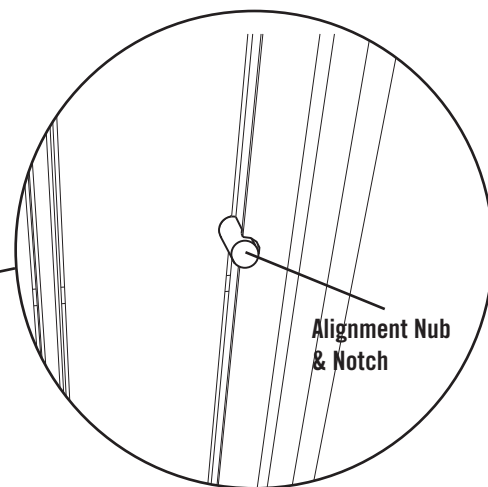

Alignment Nub & Notch

! *Note: The edge of the Roof Panel fits into the Truss Assembly.*



TOOLS AND HARDWARE REQUIRED FOR THIS PAGE

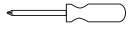

(Not actual size) **AFL** (x2)

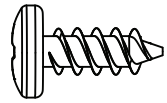

ADZ (x22)

SEC 9

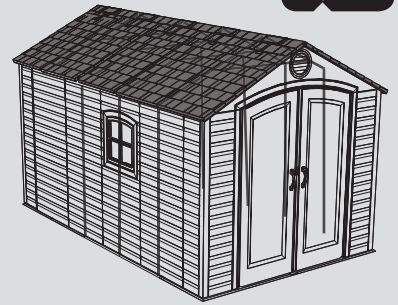

SEC

9.3

With the Roof Panel in position between the Gable and Truss, slide one (1) **Roof Support (AFL)** into place within the notches of the Roof Panel as shown. The bottom lip of the Roof Panel fits over the Wall Panel. The top of the Wall Panel fits into the groove near the bottom of the Roof Panel. After aligning the holes in the Roof Panel with those in the Wall Panels, Truss, and Gable, secure the Roof Panel to the shed using the required hardware at the locations shown.

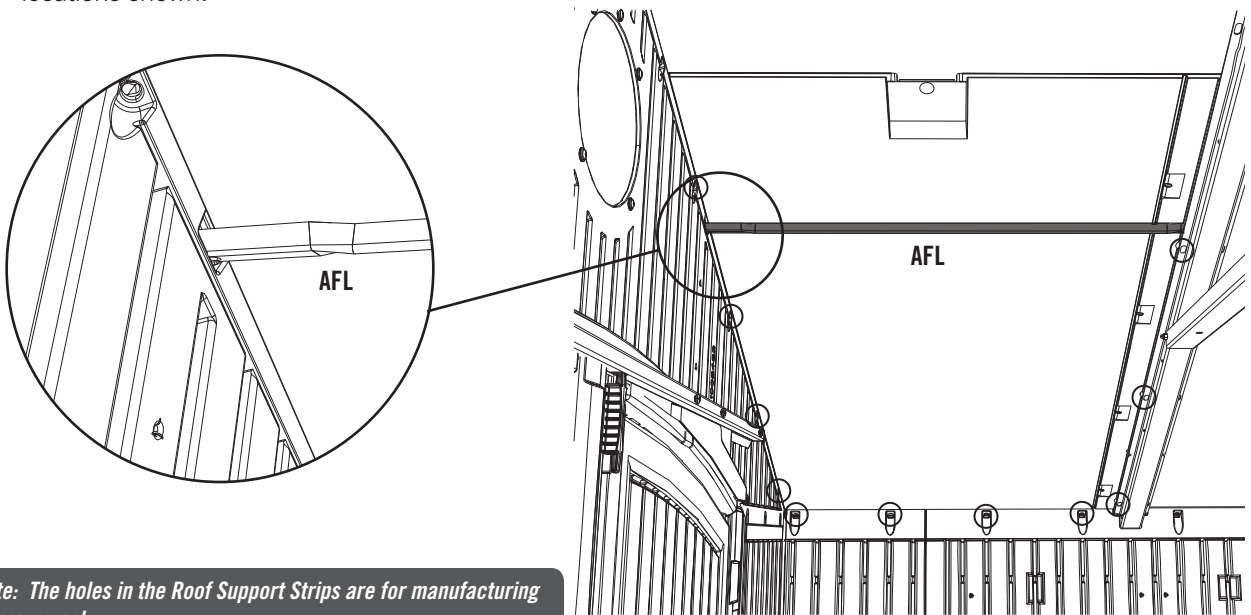

Interior Upward View



Note: The holes in the Roof Support Strips are for manufacturing purposes only.

SEC

9.4

Secure another Roof Panel and Roof Support to the right side of the shed.

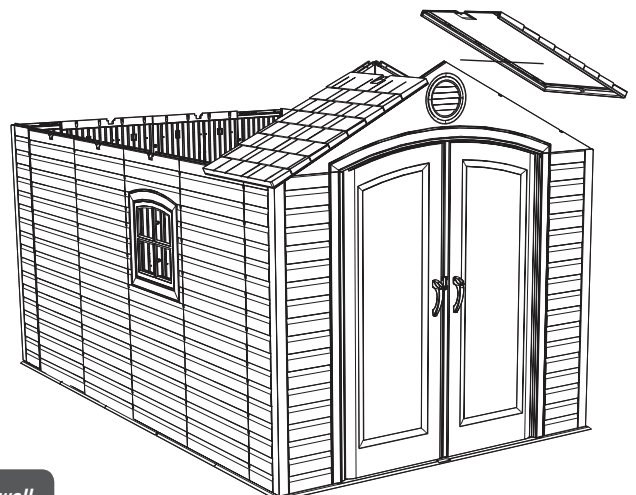

Note: Ensure the ridge in the bottom of the Roof Panel fits into the top of the wall.



TOOLS AND HARDWARE REQUIRED FOR THIS PAGE

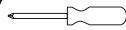

(Not actual size) **AFL** (x6)

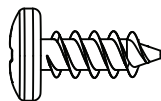

ADZ (x60)

SEC

9

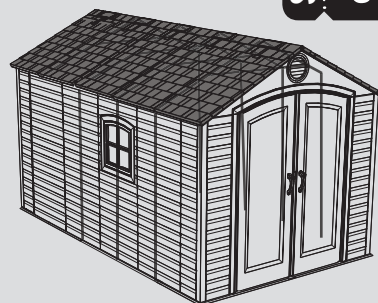

SEC

9.5

Set the second Truss Assembly into the next set of notches on opposite Wall Panels. While one adult holds the Truss Assembly in place, set a Roof Panel and Roof Support between the two Truss Assemblies. The edge of the Roof Panel fits down inside the Truss Channel. Secure the Roof Panel to the Trusses using ten (10) 1/4" x 5/8" Pan-Head Screws (ADZ). Repeat this step for the rest of the center Roof Panels and Truss Assemblies.

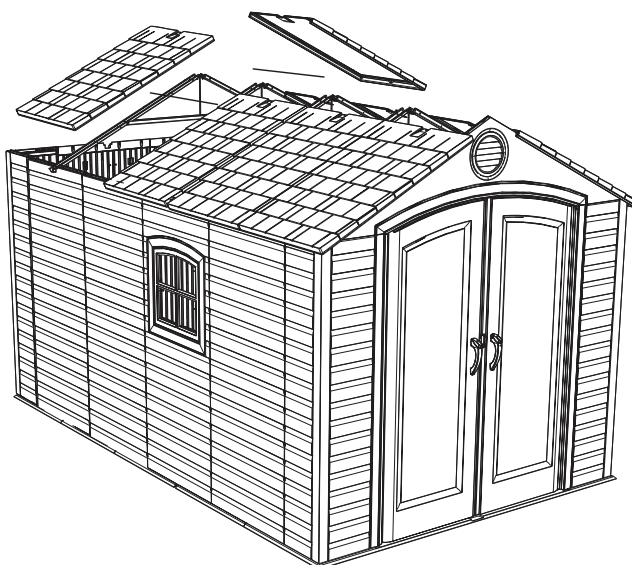
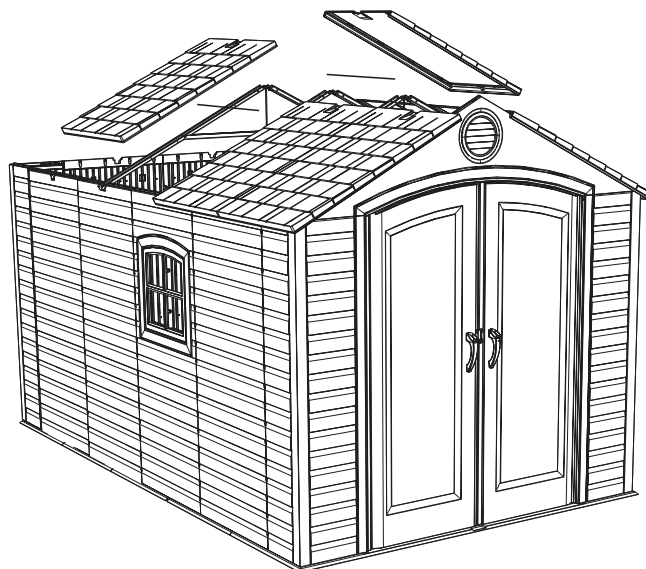
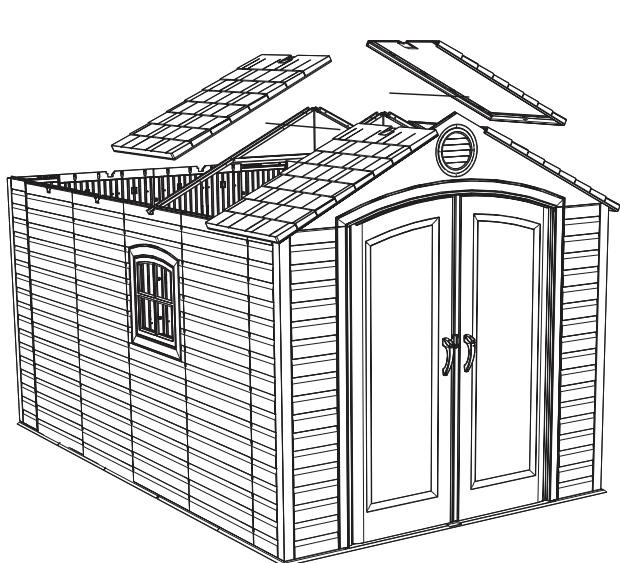



TOOLS AND HARDWARE REQUIRED FOR THIS PAGE

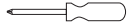

(Not actual size) **AFL** (x2)

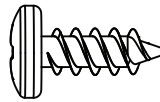

ADZ (x36)

SEC
9

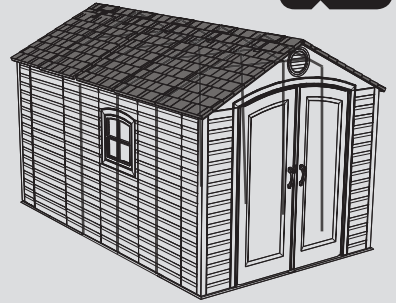

SEC

9.6

Attach the Rear Gable Assembly to the shed as shown and secure with fourteen (14) 1/4" x 5/8" Pan-Head Screws (ADZ).

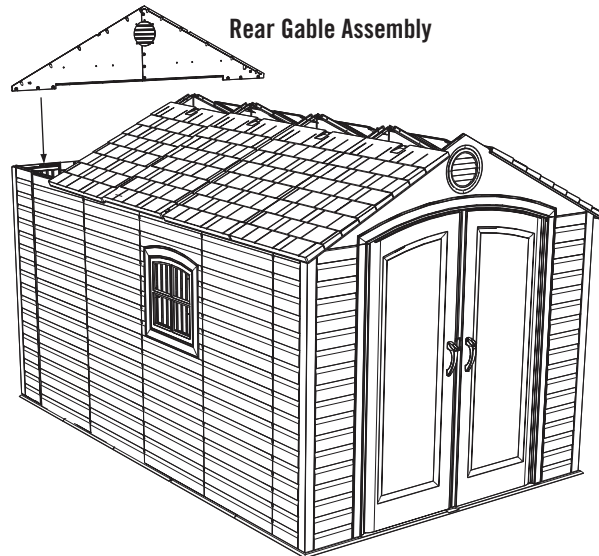

SEC

9.7

Secure the last two Roof Panels to the Truss and Rear Gable Assemblies using the required hardware. The edge of the Roof Panels fit down inside the Truss Channels. Ensure the alignment nubs in the Roof Panels fit into notches on the Trusses.

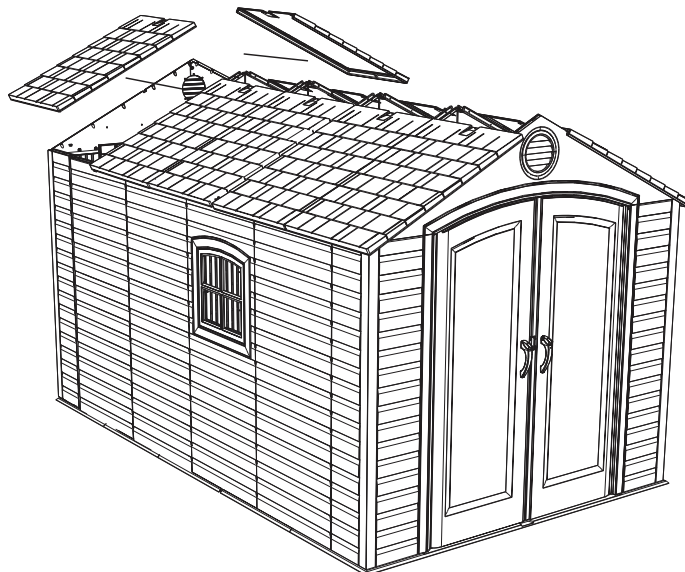



TOOLS AND HARDWARE REQUIRED FOR THIS PAGE

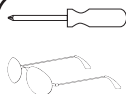

SEC 9

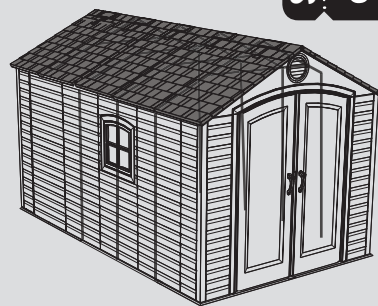

2 ADULTS REQUIRED FOR STEP 9.8 - 9.9

SEC

9.8

ROOF CAP INSTALLATION

Starting at the front side of your shed, attach the **Front Roof Cap (AGG)** to the Roof Panels and Entry Gable. Continue moving to the rear attaching the **Center Roof Caps (AFY)** to the Front Roof Cap, Roof Trusses, and one another. Finally, attach the **Rear Roof Cap (AFW)** to the Roof Panels and Rear Gable.



Note: Use only a hand screwdriver for this step.

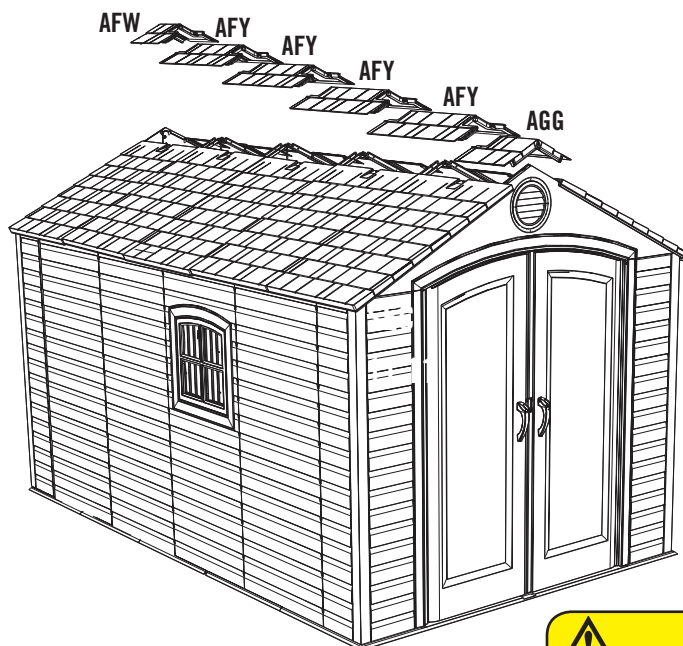

CAUTION

Only hand tighten screws. Do not overtighten. Overtightening may damage plastic parts and void warranty.

SEC

9.9

Connect the Roof Caps to each other using two (2) 1/4" x 5/8" Pan-Head Screws (ADZ). Repeat this step for all Roof Caps.

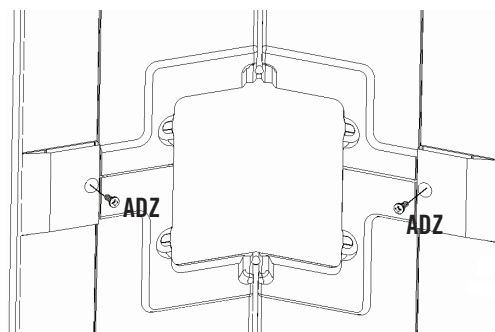



TOOLS AND HARDWARE REQUIRED FOR THIS PAGE

SEC 9

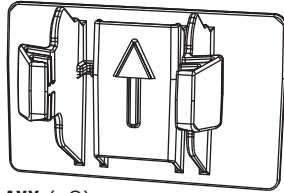
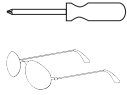

AXX (x2)
(Not to scale)

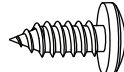

ADX (x30)

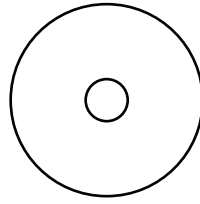

AED (x30)

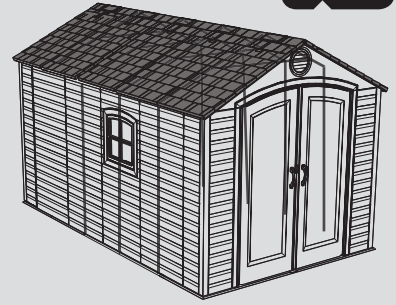

SEC

9.10

SKYLIGHT INSTALLATION

Pre-fold a **Skylight (AHC)** before installing. Push the folded Skylight up through opening between Roof Caps; open the Skylight; use tabs to pull the Skylight down into place. Fasten the Skylight in place with six (6) **#10 x 1" Fender Washers (AED)** and six (6) **#10 x 1/2" Pan-Head Screws (ADX)** (pull down on the tabs while inserting screws to provide resistance). **Repeat this step for the other four Skylights.**

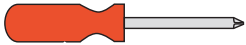

Note: Use only a hand screwdriver for this step.

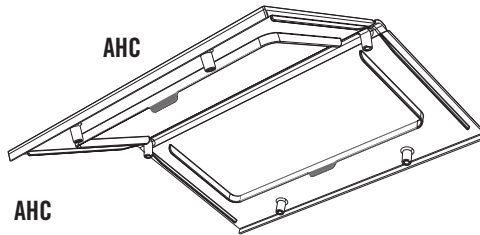

AHC

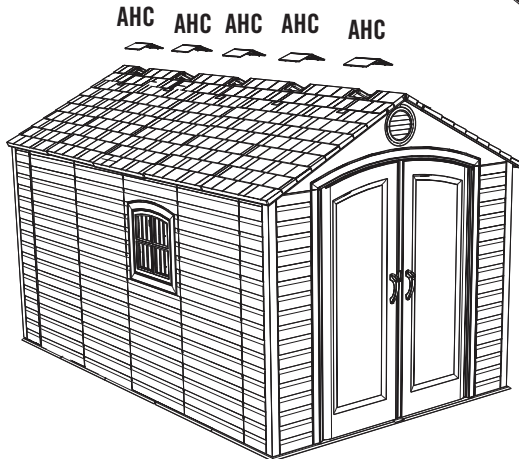

AHC AHC AHC AHC AHC

Pull down on tabs while inserting screws.

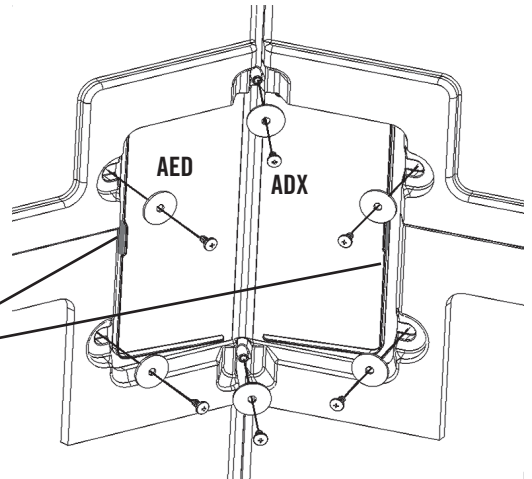

SEC

9.11

GABLE CLIP INSERTION

Insert the **Truss Hole Inserts (AXX)** between the rear Gable and the rear Wall of the Shed as shown.

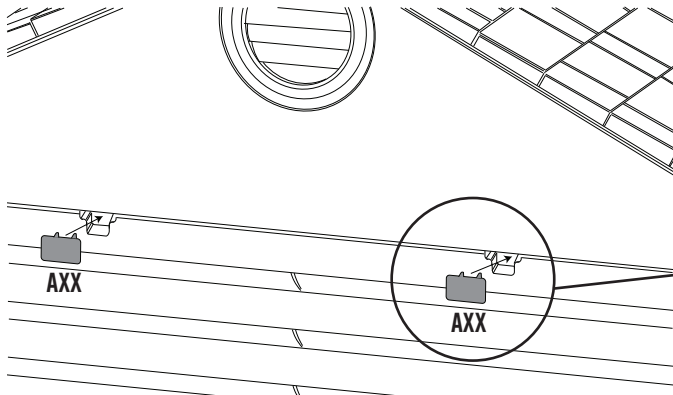

Note: Gable Clip can only be inserted with the arrow pointing up.

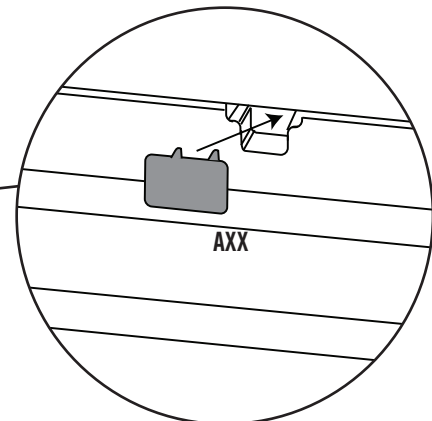

SEC 10 SHELF INSTALLATION

HARDWARE REQUIRED

HARDWARE BAGS REQUIRED: BHH (x3), BHI (x2)

Hardware shown at actual size

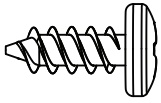

ADZ (x42)
1/4" x 5/8" Pan-Head Screw
(Only 30 are used)

Parts shown at 15% of actual size



AIY (x6)
Shelf Support Bracket

Hardware shown at actual size

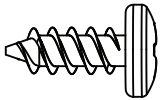

ADZ (x8)
1/4" x 5/8" Pan-Head Screw

METAL PARTS REQUIRED

METAL PARTS KIT REQUIRED: CAT

Parts shown at 8% of actual size

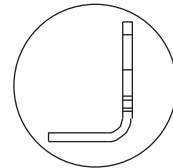
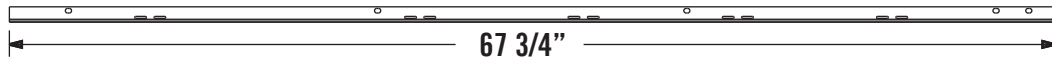

AFM (x2)
Wall/Shelf Support Channel

PLASTIC PARTS REQUIRED

SMALL PARTS KIT REQUIRED: CAQ

Part shown at 4% of actual size



AFV (x1)
90" Shelf



1002314
AFS (x2)
10" x 30" Shelf

Part shown at 8% of actual size

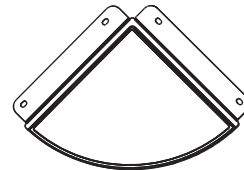

AFZ (x2)
Corner Shelf

TOOLS REQUIRED

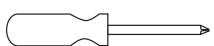

Phillips Screwdriver

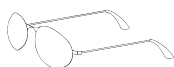

Safety Glasses



TOOLS AND HARDWARE REQUIRED FOR THIS PAGE

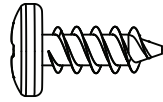
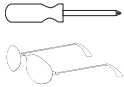

ADZ (x8)

SEC 10

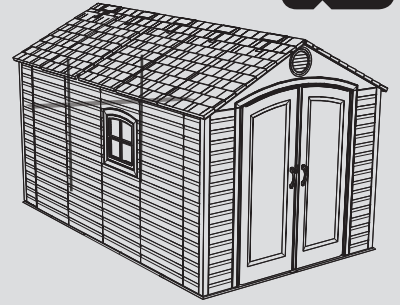

SEC

10.1

WALL/SHELF SUPPORT CHANNEL INSTALLATION

Insert a **Shelf Support Channel (AFM)** into the slots in the Wall Panels directly below the Right Truss notch, and secure with four (4) **1/4" x 5/8" Pan-Head Screws (ADZ)**. Insert a second Shelf Support Channel in the slot directly to the right of the Left Truss Notch and secure with four (4) **1/4" x 5/8" Pan-Head Screws**.

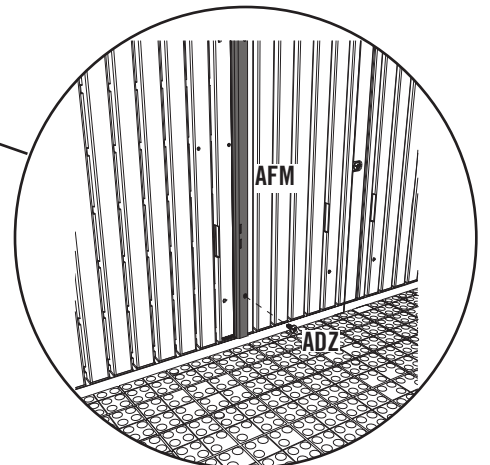
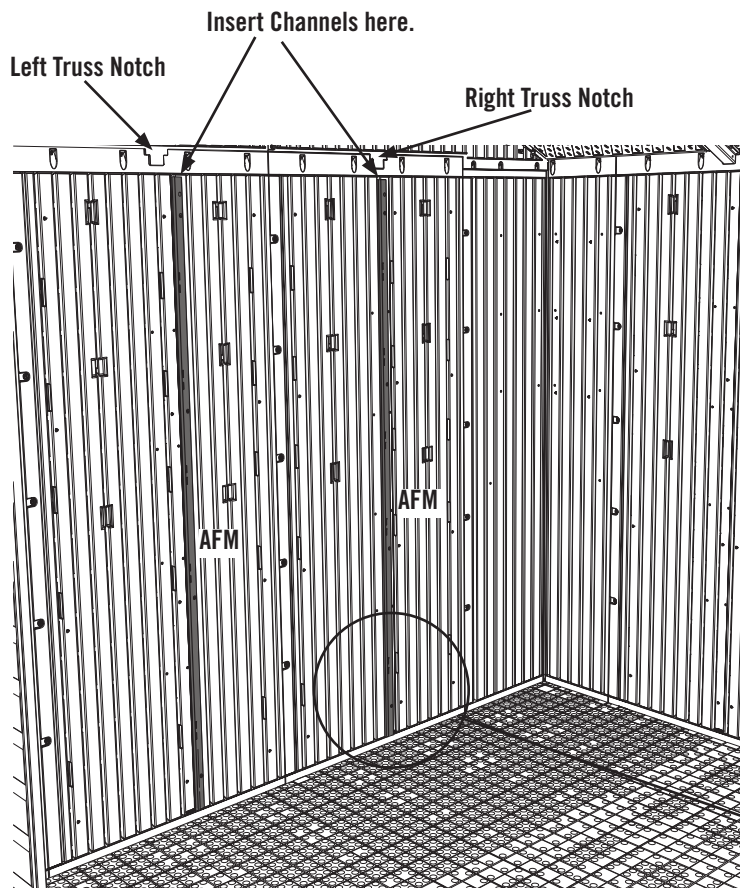



TOOLS AND HARDWARE REQUIRED FOR THIS PAGE

SEC 10

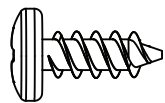
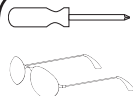

ADZ (x6)

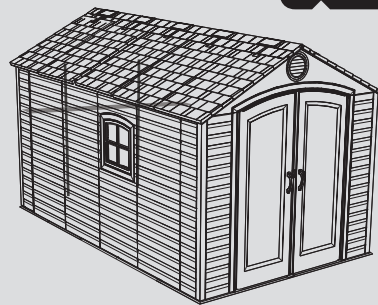

SEC

90" SHELF INSTALLATION

10.2

Set a **Shelf Support Bracket (AIY)** into the slots of each of the Shelf Support Channels. The slots must be at the same height.

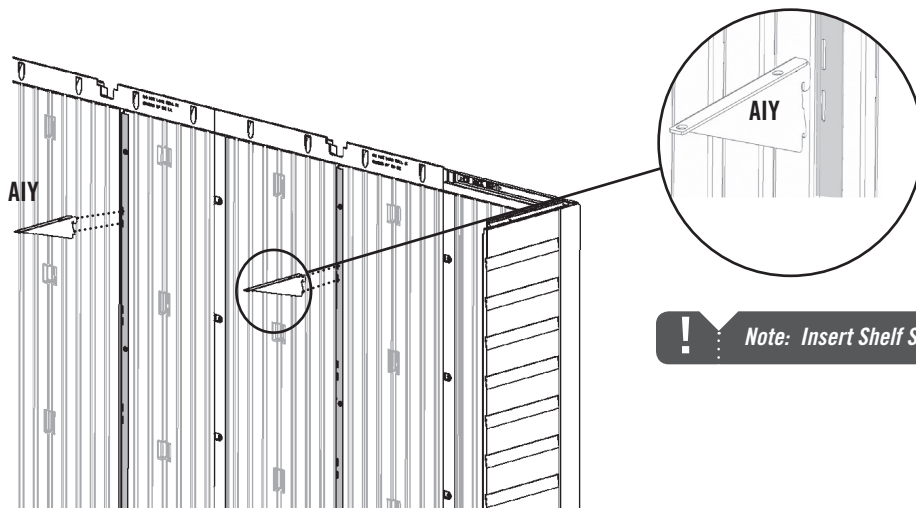

Note: Insert Shelf Support Bracket at an angle.

SEC

10.3

Fold up flaps on the end of **90" Shelf (AFV)**. Set Shelf on Brackets with indentations toward wall, and secure with six (6) **1/4" x 5/8" Phillips Pan-Head Screws (ADZ)**.

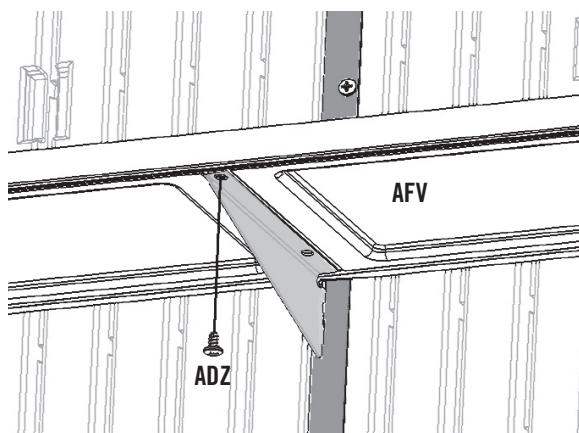

Upward view

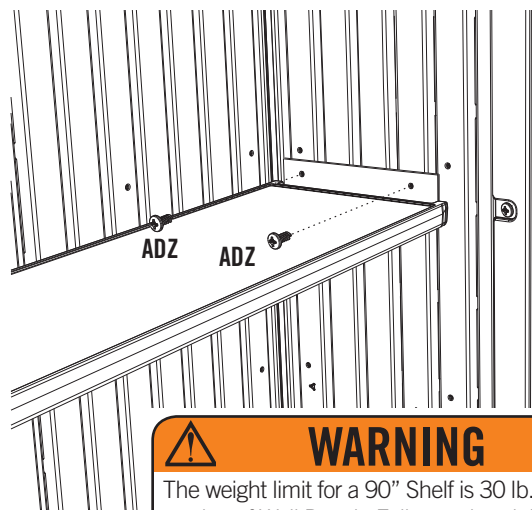

WARNING

The weight limit for a 90" Shelf is 30 lb. per 30" section of Wall Panel. Failure to heed this warning could result in property damage and/or personal injury.



Note: There are only holes for screws along front side of the Shelf (front is labeled "Front" on underside of Shelf).



TOOLS AND HARDWARE REQUIRED FOR THIS PAGE

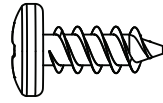
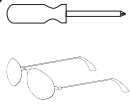

ADZ (x8)

SEC 10

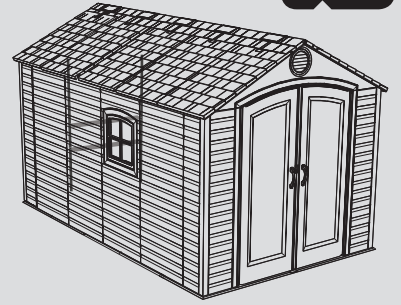

SEC

10.4

10" x 30" SHELF INSTALLATION

Insert a pair of **10" Shelf Support Brackets (AIY)** into the slots in the Wall/Shelf Support Channels and set a **10" x 30" Shelf (AFS)** on Brackets. Secure with four (4) **1/4" X 5/8" Phillips Pan-Head Screws (ADZ)**. Repeat this step for the second 10" x 30" Shelf.

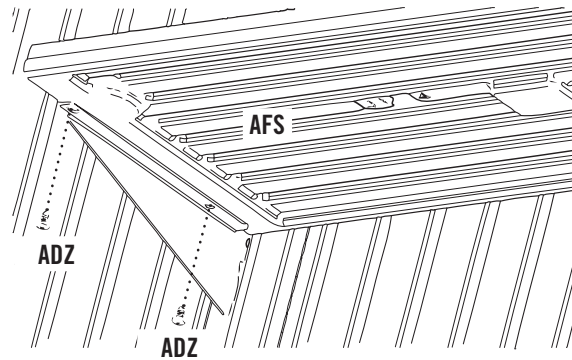
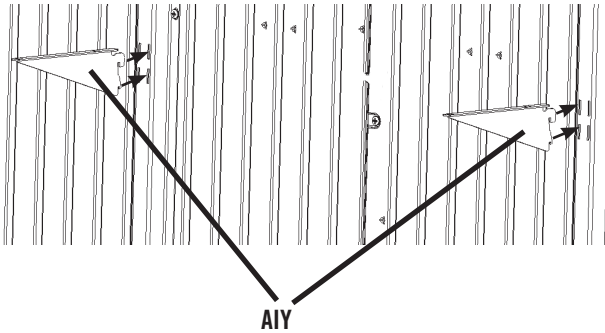

WARNING

The total weight placed on a 10" x 30" Shelf cannot exceed 30 pounds (14kg.) per Wall Panel.



TOOLS AND HARDWARE REQUIRED FOR THIS PAGE

SEC 10

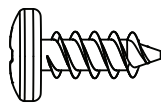
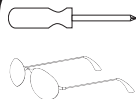

ADZ (x8)

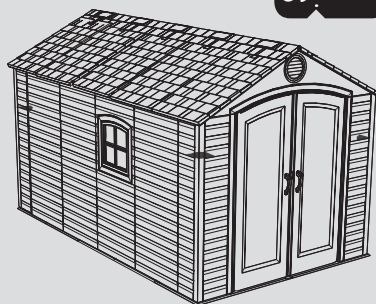

SEC

10.5

CORNER SHELF INSTALLATION

Fold up edges of a **Corner Shelf (AFZ)**. Line-up holes in the Corner Shelf with a set of pre-made holes in any Corner Panel as shown. Secure with four (4) **1/4" x 5/8" Phillips Pan-Head Screws (ADZ)**. Repeat this step for the second **Corner Shelf**.

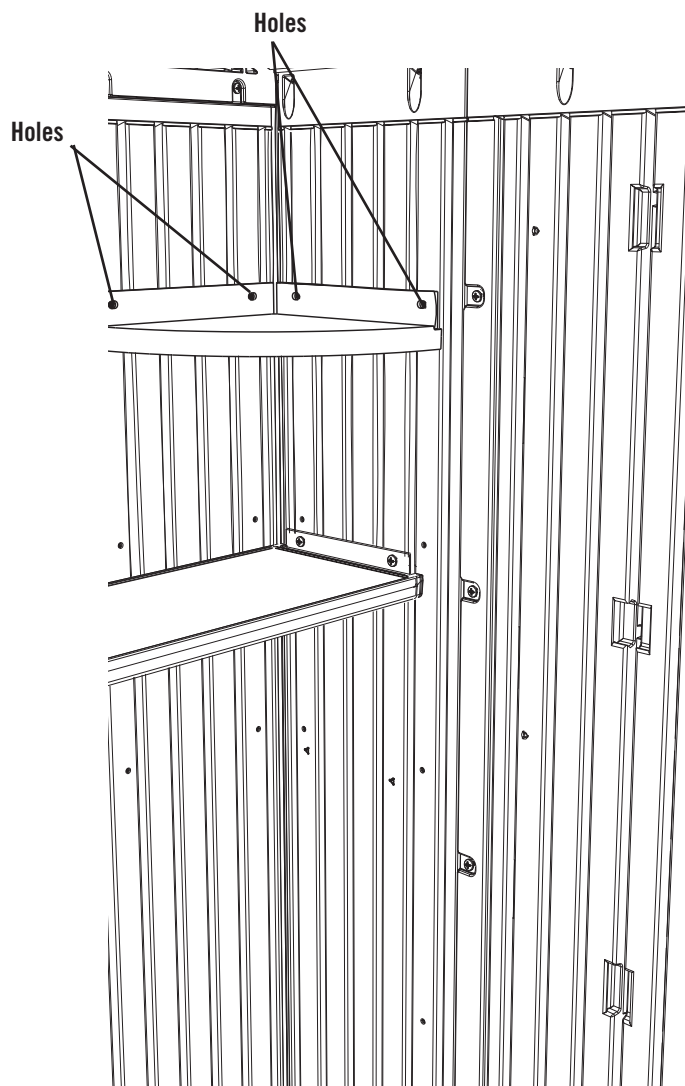
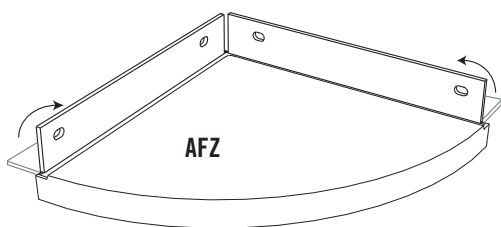

WARNING

The total weight placed on a Corner Shelf cannot exceed 10 lb. (4.5 kg).

SEC 11 WINDOW INSTALLATION

HARDWARE REQUIRED

HARDWARE BAG REQUIRED: BEJ

Hardware shown at actual size (*Unless indicated otherwise)

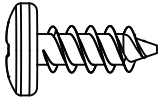

ADZ (x8)
1/4" x 5/8" Pan-Head Screw

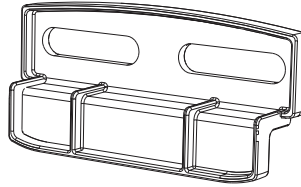

***AIS (x4)**
Window Latch

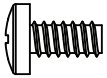

ADY (x2)
#10 x 3/8" Pan-Head Screw

PLASTIC PARTS REQUIRED

LOCATED IN BOX 2

Part shown at 4% of actual size

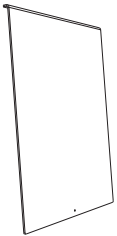

AHE (x2)
Window

TOOLS REQUIRED



Phillips Screwdriver

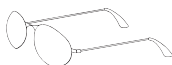

Safety Glasses



TOOLS AND HARDWARE REQUIRED FOR THIS PAGE

SEC 11

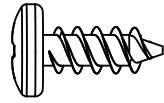
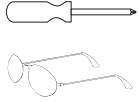

ADZ (x8)

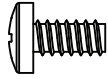

ADY (x2)

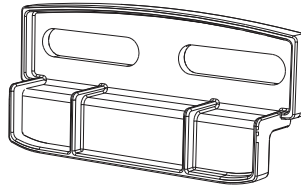

AIS (x4)
(Not to scale)

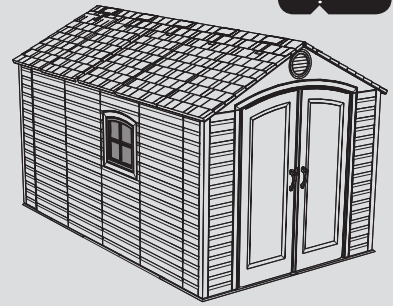

SEC

11.1

WINDOW INSTALLATION

Remove the plastic protective film from **both sides** of the **Window (AHE)** and slide the Window into the grooves along the sides of the opening in the Window Wall Panel (Fig. 1). Insert the **#10 x 3/8" Pan-Head Screw (ADY)** into the hole at the bottom of the Window (Fig. 2) until flush. Attach a **Window Latch (AIS)** above each corner of the Window as shown. When tightening the four (4) **1/4" x 5/8" Pan-Head Screws (ADZ)**, ensure the Window Latches slide freely (Fig. 3). Do not overtighten. **Repeat this step for the second Window.**

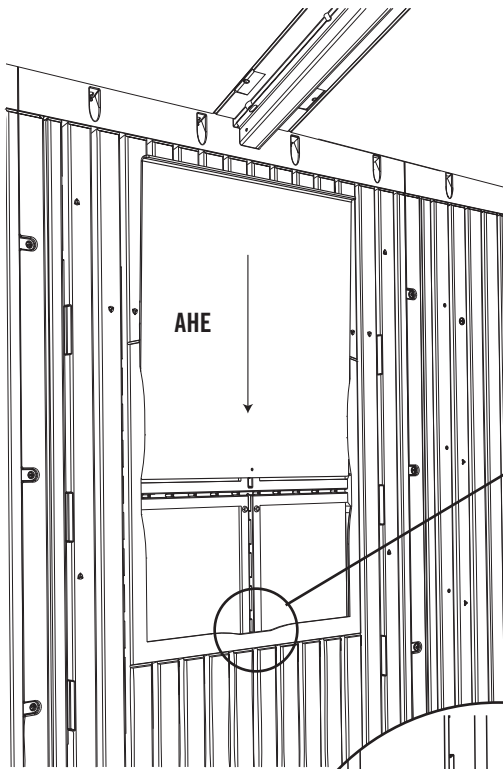

Fig. 1

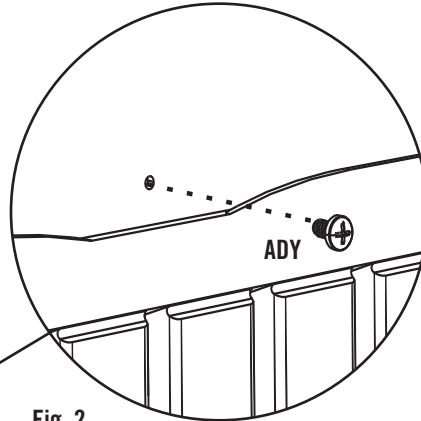

Fig. 2

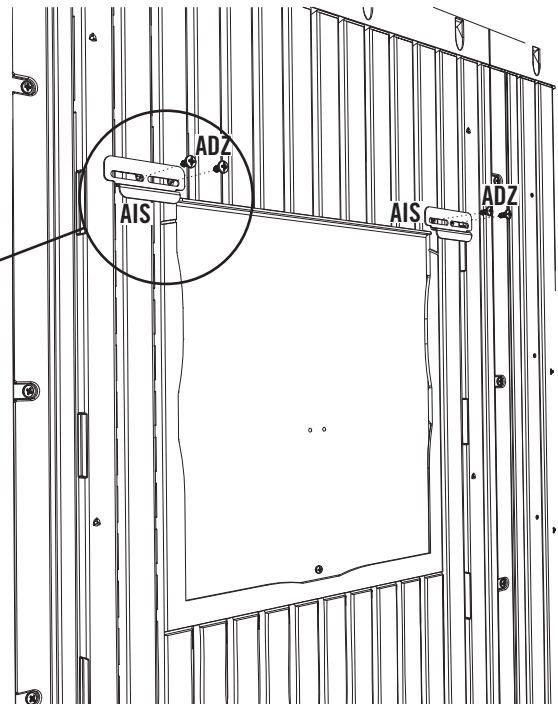
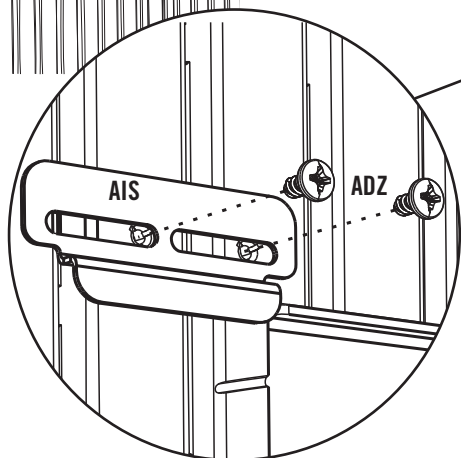

Fig. 3



Note: Insert Window with bent edge at top and pointing away from the wall.

SEC 12 DOOR ALIGNMENT

HARDWARE REQUIRED

NO HARDWARE PROVIDED FOR THIS SECTION

TOOLS REQUIRED

SMALL PARTS BOX REQUIRED: CAU

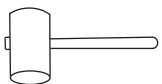

Rubber Mallet



**AIX (x4)
Wood Shim (Provided)**

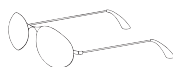

Safety Glasses



TOOLS AND HARDWARE REQUIRED FOR THIS PAGE

SEC 12

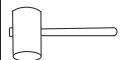

NO HARDWARE PROVIDED FOR THIS PAGE

AIX (x4)
Wood Shim (Not actual size)

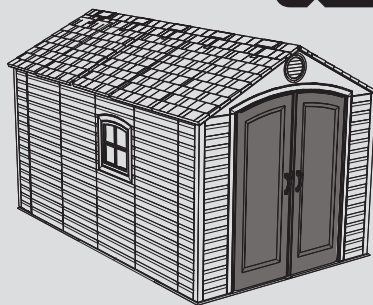

SEC

12.1

DOOR ALIGNMENT

In some cases, the shed doors may not completely line up at the tops (fig. 1). When this happens, identify which side is higher and use a **Wooden Shim (AIX)** to slightly raise the back corner of the high side until doors line up (fig. 2). If doors need further adjustment, insert another shim under the front corner opposite of the first shim. If the doors still need further adjustment, stack additional shims (one at a time) alternating between the back and front shims. After doors are aligned, cut off any portion of wood shim that is still exposed. From inside the shed, drive a 1" nail through the floor into the shim to hold it in place. **Tighten all anchoring hardware now.**

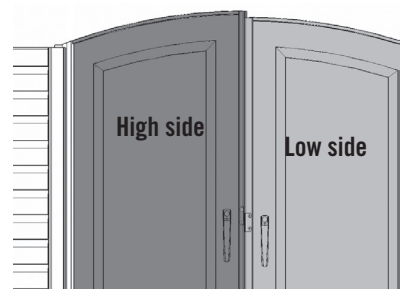

Fig. 1

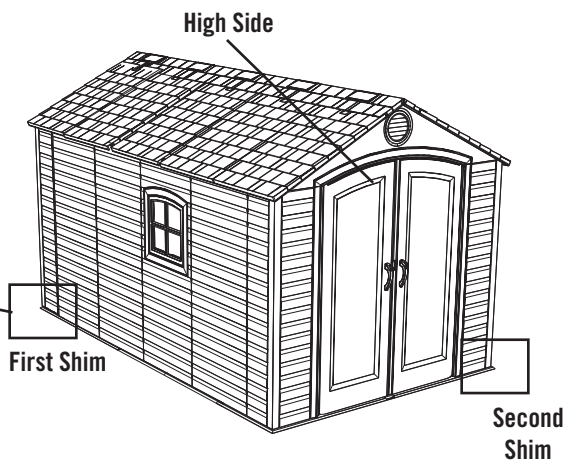
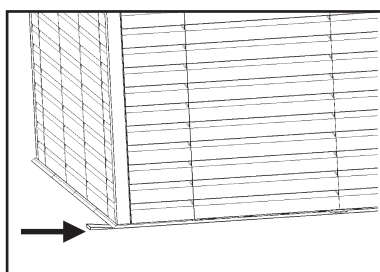

Fig. 2



Note: Shim should be placed at the corner, running directly under one wall.

CLEANING & CARE

Congratulations on your Lifetime® product purchase. By following the instructions below, your new Lifetime product should provide you with years of service and enjoyment.

Cleaning and Care

The polyethylene panels are stain- and solvent-resistant. Most stains can be removed, using a mild soap and a soft-bristled brush. Abrasive cleaning materials may scratch the plastic and are not recommended. Repair scratches or rust spots on the metal by sanding the affected area lightly; using a rust preventative spray primer; and finally, spraying with a high-gloss spray enamel paint. Avoid placing a direct heat source on or near surfaces unless using a heat barrier.

LIFETIME OUTDOOR SHED EQUIPMENT

10-YEAR LIMITED FACTORY WARRANTY

THE MANUFACTURER RESERVES THE RIGHT TO MAKE SUBSTITUTIONS TO WARRANTY CLAIMS IF PARTS ARE UNAVAILABLE OR OBSOLETE.

1. Lifetime outdoor sheds are warranted to the original purchaser to be free from defects in material or workmanship for a period of ten years from the date of original retail purchase. The word “defects” is defined as imperfections that impair the use of the product. Defects resulting from misuse, abuse or negligence will void this warranty. This warranty does not cover defects due to improper installation, alteration or accident. This warranty does not cover damage caused by vandalism, rusting, “acts of nature” or any other event beyond the control of the manufacturer.
2. This warranty is nontransferable and is expressly limited to the repair or replacement of defective product. If the product is defective within the terms of this warranty, Lifetime Products, Inc. will repair or replace defective parts at no cost to the purchaser. Shipping charges to and from the factory or distribution center are not covered and are the responsibility of the purchaser. Labor charges and related expenses for removal, installation or replacement of the shed or its components are not covered under this warranty.
3. This warranty does not cover scratching or scuffing of the product that may result from normal usage. In addition, defects resulting from intentional damage, negligence, unreasonable use or hanging from the truss will void this warranty.
4. Liability for incidental or consequential damages is excluded to the extent permitted by law. While every attempt is made to embody the highest degree of safety in all equipment, freedom from injury cannot be guaranteed. The user assumes all risk of injury resulting from the use of this product. All merchandise is sold on this condition, and no representative of the company may waive or change this policy.
5. This product is not intended for institutional or commercial use; Lifetime Products, Inc. does not assume any liability for such use. Institutional or commercial use will void the warranty.
6. This warranty is expressly in lieu of all other warranties, expressed or implied, including warranties of merchantability or fitness for use to extent permitted by Federal and state law. Neither Lifetime Products, Inc., nor any representative assumes any other liability in connection with this product. This warranty gives you specific legal rights, and you may also have other rights which vary from state to state.

PLEASE INCLUDE YOUR DATED SALES RECEIPT AND PHOTOGRAPHS OF DAMAGED PARTS.

REPORT PRODUCT DEFECTS IN WRITING TO:

Lifetime Products, Inc., PO Box 160010 Clearfield, UT 84016-0010
or call 1-800-225-3865 M-F 7 a.m. to 5 p.m. MST.

REGISTER YOUR PRODUCT FOR QUICKER CUSTOMER SERVICE.

Visit www.lifetime.com or call 1-800-225-3865 to register your product today.

FOR INTERNATIONAL WARRANTY CLAIMS:

All warranty claims must be accompanied by a sales receipt. Report all warranty claims in writing to your regional sales support representative. Please include your dated sales receipt and photographs of damaged parts.

To identify the representative for your region — Please visit: www.lifetime.com/international



www.lifetime.com

ENHANCE YOUR LIFETIME® PURCHASE BY ADDING ACCESSORIES OR OTHER GREAT PRODUCTS

To purchase accessories or other Lifetime Products, visit us at:

www.lifetime.com

Or call: 1-800-424-3865

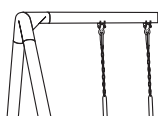



OUTDOOR STORAGE

MODEL N° 6422

OWNER'S MANUAL

Keep this Identification Number in case you need to contact our Customer Service Department.

IMPORTANT! PLEASE READ BEFORE BEGINNING ASSEMBLY

Dear Valued Customer,

We would like to congratulate you on your purchase of a Lifetime® Outdoor Storage Shed! We are confident that you have made the perfect choice and you will be very pleased with your new storage solution.

Lifetime® Outdoor Storage is part of the family of products created and manufactured by Lifetime® Products, Inc. Like all of our products, you can be assured that the quality of your Lifetime Outdoor Storage Shed is the best in the world! And, we back that quality up by offering the best warranty in the business – A 10-year warranty that fully covers the Shed!

All of our Sheds are built with the highest-quality steel and high-density polyethylene (HDPE) parts. The design and construction of our steel-reinforced double-Wall Panels is second to none. All of our exposed steel parts and gables are powder coated and we use high-density polyethylene plastic. What makes polyethylene so special? It has superior strength and durability, and, it won't crack or degrade outdoors.

So now that you know the quality you are getting in a Lifetime Outdoor Storage Shed, please take the time to **READ THIS INSTRUCTION MANUAL!**

We have taken great care in providing the best possible form of instructions to help you put your new Outdoor Storage Shed together. Before you get started, **PLEASE** read the following preparation tips to help you get started!

We can assure you, your construction experience will be a lot more enjoyable if you do!

PREPARATION TIPS:

- The first step is simple... **RELAX!** You have made a great purchase, but Rome was not built in a day. Plan to spend a good part of your weekend putting together your fine Outdoor Storage Shed. Our philosophy is, if it comes together quickly and easily, it surely will come apart quickly and easily! Your Lifetime® Outdoor Storage Shed will surely last a long, long time, if you are patient, and take all the time necessary to put it together as we have instructed.
- Grab a friend to join in on the fun! This is not a one-person endeavor. We have found that not only will things go smoother if you have two or more people participating in the construction of the Shed, but it will go quicker as well. So, the more the merrier!
- Make sure you have all the tools necessary for constructing your new Shed. There is a "Tools Required For This Assembly" list on page five of this Owner's Manual.
- The plastic pieces of your Shed may become damaged by over tightening the screws. To avoid this damage, we strongly recommend the use of a low-powered power screwdriver or a drill that has an adjustable clutch that is set on a low-torque setting. If neither is available, use a hand screwdriver. If a hand screwdriver is all you have, take several breaks... your wrist will need it!
- You will also need two small ladders (when it comes time to do the roof!).

IMPORTANT! PLEASE READ BEFORE BEGINNING ASSEMBLY

- Before beginning assembly, remove the Parts List from the center of this Owner's Manual and take an inventory of the parts included with your Outdoor Storage Shed. Also, read through the entire instruction manual. It's always a great practice to get a feel for the flow of the process and to familiarize yourself with the parts involved. But, try not to get ahead of yourself and start the process out of order.
- **FOLLOW THE INSTRUCTIONS IN ORDER!** Everything goes together in a certain order, and we have learned what that correct order should be. In our state-of-the-art research and testing facility, we have painstakingly created these instructions. The order of construction is there for a reason, and some parts simply will not fit if built out of order. Just follow along with the order in the instructions and everything will fit together and things will go very smooth.
- **YOUR SHED MUST BE BUILT ON A LEVEL SURFACE!** If the spot you have chosen to place your wonderful new Outdoor Storage Shed is not level, the Shed will not assemble correctly! We recommend a concrete patio, a wood platform or creating a pad with pea gravel. Your Shed is meant to last a lifetime, so provide the proper foundation for it before you start to build.
- Before you build it, make sure you are allowed to build it! Consult all building codes, as well as city and county ordinances, to ensure that you do not require a building permit to construct your Outdoor Storage Shed. Proper building permit documentation may be required in your neighborhood, and it would be quite unfortunate to learn this after your Outdoor Storage Shed is already built!

Now that you're ready to begin the construction of your wonderful new Outdoor Storage Shed, step back, take a deep breath, get yourself a large cold beverage and enjoy yourself. We guarantee that after spending the right amount of time in building your Shed, you will be able to enjoy it for years to come.

Thanks for choosing Lifetime®, and have fun!

ABOUT LIFETIME PRODUCTS, INC.

Lifetime Products, Inc., has applied innovation and cutting-edge technology in plastics and metals to create a family of affordable lifestyle products that feature superior strength and durability. The world's leading manufacturer of folding tables and chairs, Lifetime was founded in 1986 as the maker of portable basketball systems that revolutionized the industry with patented technology. With diverse offerings such as outdoor storage sheds and steel utility trailers, Lifetime continues to develop innovative products that outfit the way you live.

Lifetime makes the things you need for the lifestyle you want. By innovating products in and around the home, Lifetime simplifies your everyday life and enables you to get the most out of your free time.



REGISTER YOUR LIFETIME PRODUCT TODAY!

There are benefits to registering your Lifetime product. With our new online product registration form, it's fast and easy! Register with us at www.lifetime.com and enjoy these great benefits:

- Receive exclusive money-saving offers from BuyLifetime.com, our online store, as well as NEW product notifications and special closeout promotions!
- In the unlikely event of a product recall or safety modification, we will notify you.
- Registering your product guarantees you warranty service. If you do not register your product, your warranty rights will not be diminished. But you will need to provide a sales receipt to verify your product purchase date before warranty service will be provided.

LIFETIME'S PROMISE TO YOU:

Maintaining your privacy is our long-standing policy at Lifetime. And you can rest assured that Lifetime will not sell or provide your personal data to other third parties, or allow them to use your personal data for their own purposes.

We invite you to read our privacy policy at www.lifetime.com

REGISTER today!

****U.S. and Canada customers ONLY****

IF ASSISTANCE IS NEEDED,

DO NOT CONTACT THE STORE!

CALL OUR CUSTOMER SERVICE DEPARTMENT at 1 (800) 225-3865

HOURS: 7:00 a.m. to 5:00 p.m. Monday through Friday (Mountain Standard Time)

Call, or visit our Web site for Saturday hours

For customers outside the U.S. or Canada, please contact the store for assistance.



SAFETY INSTRUCTIONS



FAILURE TO FOLLOW THESE WARNINGS MAY RESULT IN SERIOUS INJURY OR PROPERTY DAMAGE AND WILL VOID WARRANTY.

To ensure safety, do not attempt to assemble this product without following the instructions carefully. Check entire box and inside all packing material for parts and/or additional instruction material. Before beginning assembly, read the instructions and identify parts using the hardware identifier and parts list in this document. Proper and complete assembly, use and supervision are essential to reduce the risk of accident or injury.

- Do not use or store hot objects such as grills, blowtorches, welding equipment, etc. near the product.
- If using a ladder during assembly, use extreme caution.
- Two capable adults are required for assembly. (It is also recommended that a third adult function as an instruction reader.)

Most injuries are caused by misuse and/or not following instructions. Use caution when using this product.

BEFORE BEGINNING ASSEMBLY



Keep the hardware bags and their contents separate. If any parts are missing, call our Customer Service Department.



Read the "Congratulations" letter on page 2-3. Identify and inventory all parts and hardware using the parts and hardware lists and identifiers in this document.

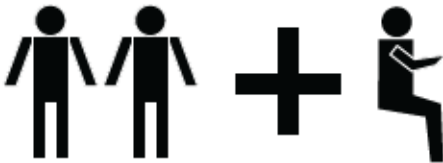

****Two adults required to complete assembly****
(+ one adult suggested as an instruction reader)

Only adults should set up the product. Do not allow children in the set-up area until assembly is complete.

IF YOU ARE INSTALLING A NEW SHED

1. Check contents of boxes and compare to parts listed on the Parts List.
2. Follow instructions that came with your shed, but add extra floor panel, wall panels, Roof Cap and Skylight at appropriate points in the assembly.

IF YOU ARE EXTENDING AN EXISTING SHED

1. Remove any bolts or screws being used to anchor the shed to the ground.
2. Remove any objects from back shelves.
3. Remove any shelves, pegboard or pegboard strips, or other objects hanging on the last two Side Wall Panels on either side.
4. Check contents of boxes and compare to parts listed on the Parts List.
5. Follow the steps in this manual.
6. If you are extending an 8' x 5' shed you will need to modify the following instructions by not removing as many parts as shown in the illustrations.



TOOLS REQUIRED FOR THIS ASSEMBLY

*Phillips Screwdriver

*Electric Drill

7/16" Wrench

3/8" Wrench

Safety Glasses

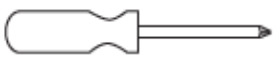

(x1)

(x1)

(x2)

(x1)

(1 pair for each person)

*See "Screwdriver Notice" on page 7.

ASSEMBLY GUIDES

Refer to the following areas throughout the instructions to assist in the assembly process:

This area is located at the top, left-hand corner of the page and indicates which tools and hardware are needed to complete the assembly steps on a page.



TOOLS AND HARDWARE REQUIRED FOR THIS PAGE



This area is located at the top, right-hand corner of the page and shows an image of the product with shaded parts indicating which section is being assembled.



This area is usually located in the bottom, left-hand corner of a step and indicates that special attention is needed to perform a particular part of a step.



Note:

These areas are usually located in the bottom, right-hand corner of a step and indicate that damage to the product or serious injury may occur if the caution or warning is not heeded.



CAUTION



WARNING

Throughout the Parts & Hardware List, Part & Hardware Identifiers, and instructions are three-letter IDs. These IDs are below the images of the parts and hardware to help you locate and identify the parts and hardware during assembly. These IDs are not necessarily on the parts themselves.



ADZ (x10)
1/4" x 5/8" Pan-Head Screw

IMPORTANT NOTICES

Level Surface Notice:

Surface must be leveled before installation. We recommend building a level work space with a concrete or patio style surface. If the surface is not properly leveled, the Outdoor Shed will not assemble correctly. Proper surface leveling will save you time in the long run, so please do not ignore this step.

Building Code Notice:

Consult all local building codes, as well as city and county ordinances, to ensure that the construction of the Outdoor Shed does not require a building permit. Proper building permit documentation may be required in your neighborhood, and it would be unfortunate to learn this after constructing the Shed.

Screwdriver Notice:

You may use a #2 Phillips head screwdriver bit and a power screwdriver or drill, instead of a hand screwdriver. However, be aware that the plastic pieces of your Shed can be damaged by overtightening of screws. To avoid damage we strongly recommend the use of a low-powered power screwdriver or a drill that has an adjustable clutch that is set on a low torque setting. If neither is available, use a hand screwdriver. In any case use caution to avoid overtightening the screws.

Floor Puncture Notice:

Sharp objects may damage your floor. If resting sharp, heavy objects on your Shed floor, place a block of wood between the sharp object and floor.

CAUTION:

If more than six (6) inches of snow accumulate on the roof of the shed, carefully remove the snow to avoid possible roof collapse. While standing on the ground, remove the snow from the roof with a broom or snow shovel. Do not stand on the roof to remove snow.

PARTS & HARDWARE LIST

ID	Description	Quantity	ID	Description	Quantity
Main Parts					
AHD	Wall Panel	2	BJL 6422 Hardware Bag		
AFX	Center Floor Panel	1	BEA Truss Assembly Hardware		
AGQ	Roof Panel	2	ADY	#10 x 3/8" Phillips Pan-Head Screw	6
AHC	Skylight	1	ADK	#10 Cap Nut	6
AFY	Center Roof Cap	1	AIP	Truss Connector	1
AFG	Roof Truss Brace	1	ADJ	1/4" Cap Nut	2
AFH	Truss Gutter Channel	2	ADH	1/4" Threaded Rod	1
AFL	Roof Support Strip	2	CSG Floor Assembly Hardware		
			BQC	#8 x 1/2" Pan-Head Screw	8
			ADC	#2 Phillips Bit	1
			BGT Wall & Roof Installation Hardware		
			ADZ	1/4" x 5/8" Phillips Pan-Head Screw	45
			BGS Skylight Installation Hardware		
			ADX	#10 X 1/2" Phillips Pan-Head Screw	6
			AED	#10 x 1" Fender Washer	6

HARDWARE IDENTIFIER

TRUSS ASSEMBLY HARDWARE [BEA]

Hardware shown at actual size (*unless otherwise indicated)

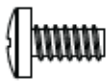

ADY (x6)
#10 x 3/8" Phillips Pan-Head Screw



ADK (x6)
#10 Cap Nut



ADJ (x2)
1/4" Cap Nut



AIP (x1)*
Truss Connector

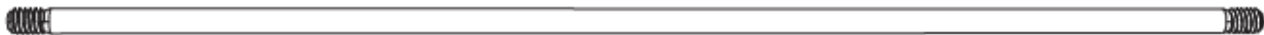

ADH (x1)*
1/4" Threaded Rod

FLOOR ASSEMBLY HARDWARE [CSG]

Hardware shown at actual size



BQC (x8)
#8 x 1/2" Pan-Head Screw

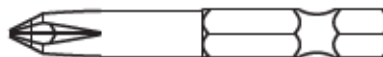

ADC (x1)
#2 Phillips Bit

WALL & ROOF INSTALLATION HARDWARE [BGT]

Hardware shown at actual size



ADZ (x45)
1/4" x 5/8" Phillips Pan-Head Screw
(Not all screws will be used)

! *Note: Throughout the Parts & Hardware List, Part & Hardware Identifiers, and instructions are three-letter IDs. These IDs are below the images of the parts and hardware to help you locate and identify the parts and hardware during assembly. These IDs are not necessarily on the parts themselves.*

HARDWARE IDENTIFIER

SKYLIGHT INSTALLATION HARDWARE [BGS]

Hardware shown at actual size



ADX (x6)
#10 x 1/2" Phillips Pan-Head Screw

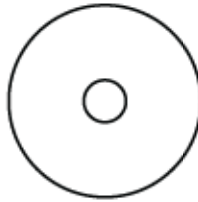

AED (x6)
#10 x 1" Fender Washer

PARTS IDENTIFIER

Parts are shown at 4% of actual size (Unless indicated otherwise*)

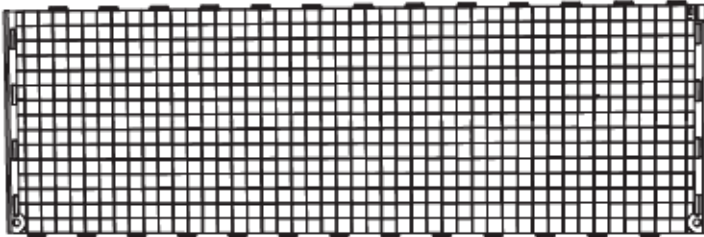

AFX (x1)
Center Floor Panel

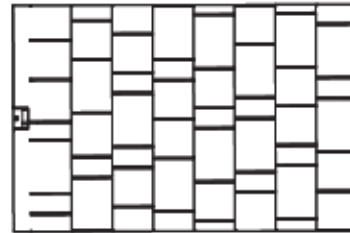

AGQ (x2)
Roof Panel

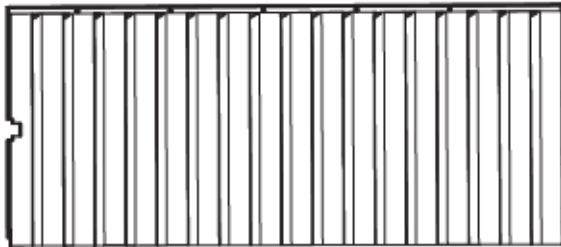

AHD (x2)
Wall Panel

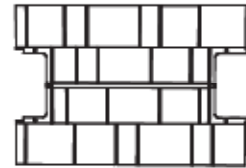

AFY (x1)
Center Roof Cap

Parts are shown at 8% of actual size

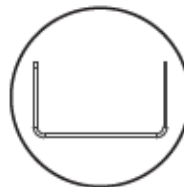
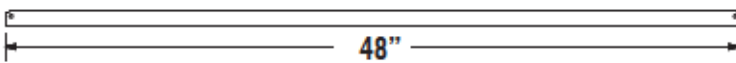

AFG (x1)
Roof Truss Brace

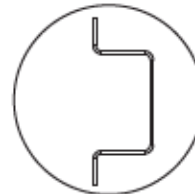
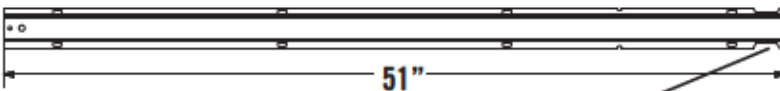

AFH (x2)
Truss Gutter Channel

Notched end goes over
Wall Panel



AFL (x2)
Roof Support Strip

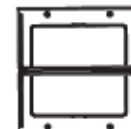

AHC (x1)
Skylight



TOOLS AND HARDWARE REQUIRED FOR THIS PAGE



NO HARDWARE REQUIRED FOR THIS PAGE

SEC 1

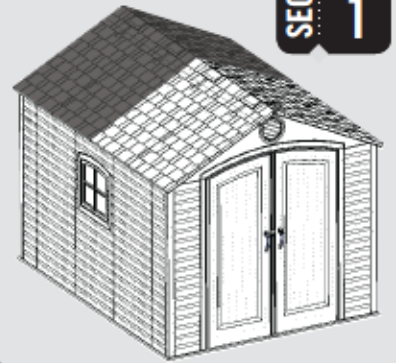

****SAVE ALL HARDWARE FOR RE-ASSEMBLY!****

SEC

SHED DISASSEMBLY

1.1

Remove last three Skylights and set aside.

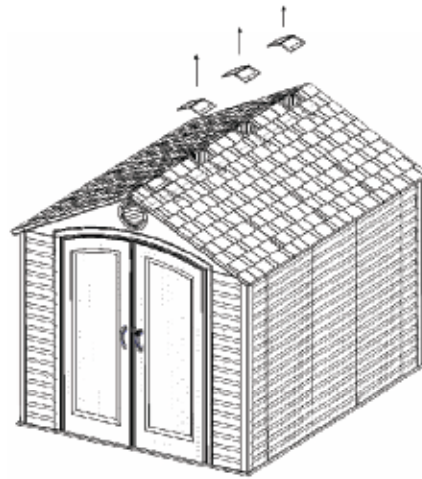

Note: Your Shed may be a different length than the Shed shown, but the ideas are the same.

SEC

1.2

Remove the back two Center Roof Caps and the End Roof Cap and set aside.

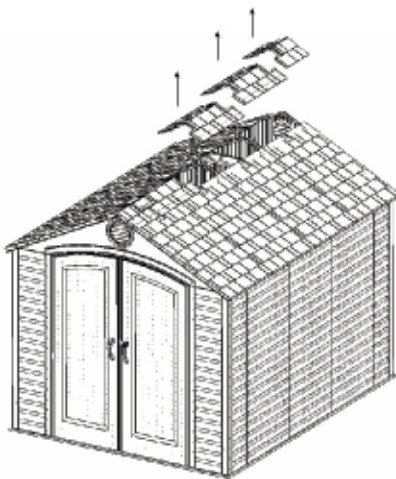

SEC

1.3

Remove the back Roof Panels and Roof Support Strips and set aside.

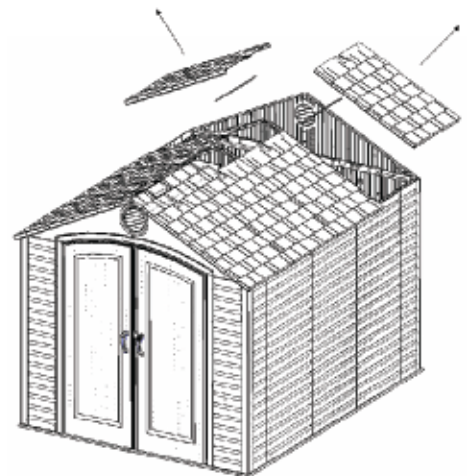



TOOLS AND HARDWARE REQUIRED FOR THIS PAGE



NO HARDWARE REQUIRED FOR THIS PAGE

SEC 1

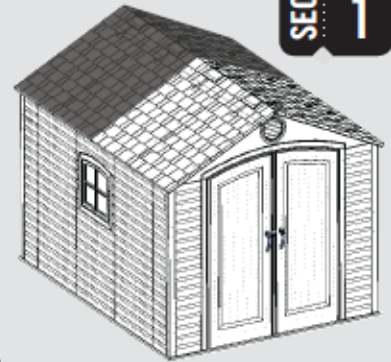

****SAVE ALL HARDWARE FOR RE-ASSEMBLY!****

SEC

1.4

Remove the next Roof Panels and Roof Support Strips and set aside.

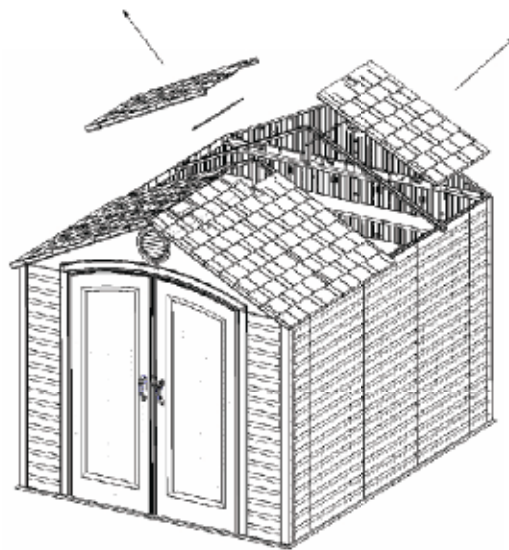

SEC

1.5

Remove the Roof Truss Assembly and set aside.

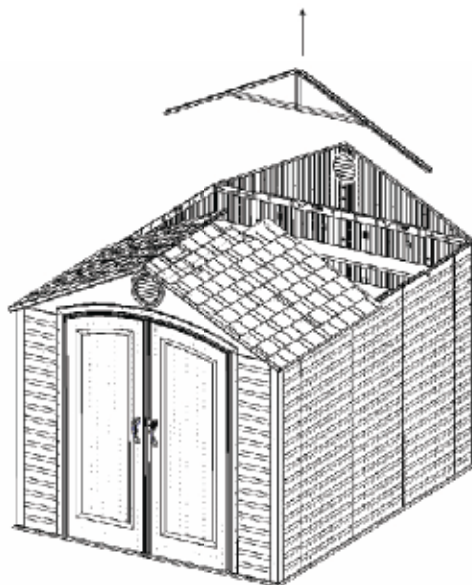



TOOLS AND HARDWARE REQUIRED FOR THIS PAGE



NO HARDWARE REQUIRED FOR THIS PAGE

SEC 1

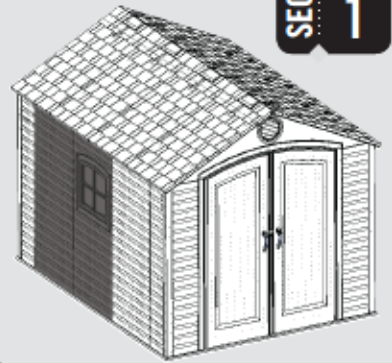

****SAVE ALL HARDWARE FOR RE-ASSEMBLY!****

SEC

1.6

Remove the last two side Wall Panels and set aside.

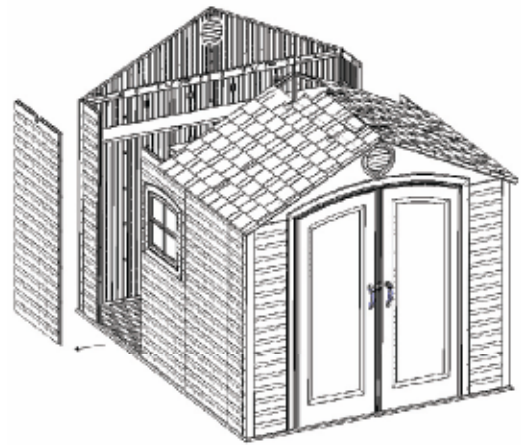
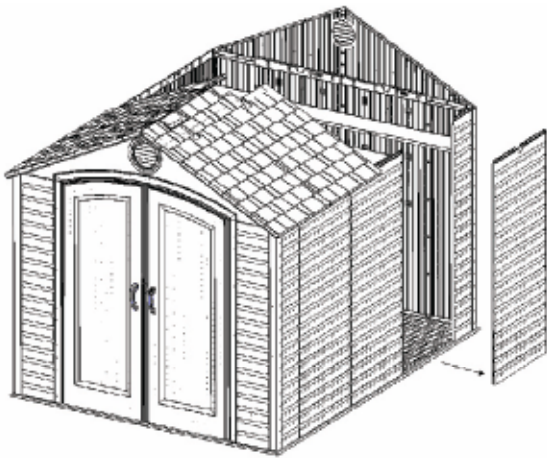

SEC

1.7

Slide the rear section of the Shed away from the front. You will need to tip the rear section forward slightly in order to disconnect the Floor Panels

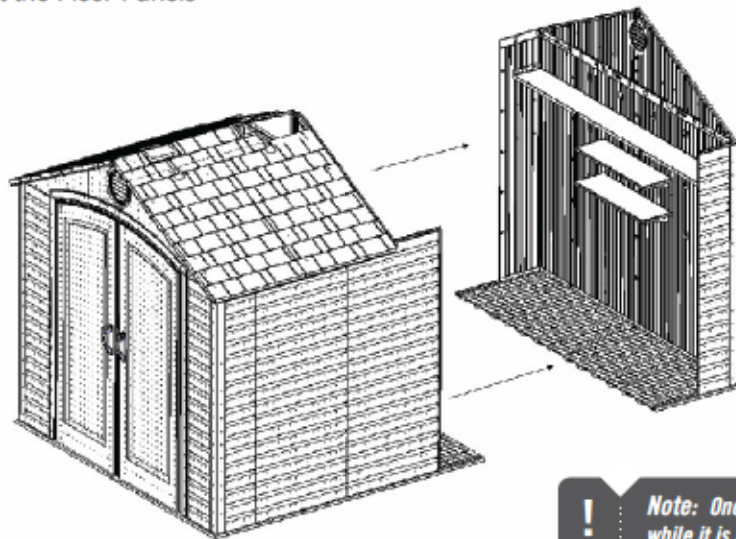

Note: One person should support the rear Wall while it is being tipped and moved.



Note: Ensure there is nothing on the rear Shelves before moving the rear section of the Shed.

SEC 2 FLOOR ASSEMBLY

HARDWARE REQUIRED

HARDWARE BAG REQUIRED: CSG

Hardware shown at actual size



BQC (x8)
#8 x 1/2" Pan-Head Screw



ADC (x1)
#2 Phillips Bit

PLASTIC PARTS REQUIRED

Part shown at 4% of actual size

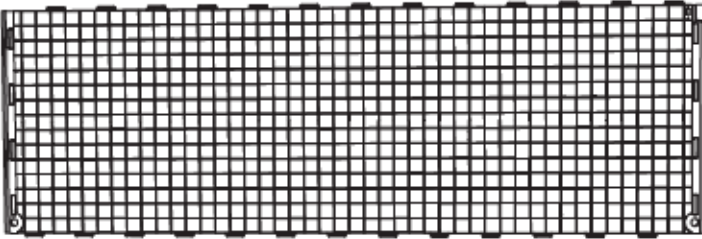

AFX (x1)
Center Floor Panel

TOOLS REQUIRED

HARDWARE BAG REQUIRED: CSG



Phillips Screwdriver



Safety Glasses



ADC (x1)
#2 Phillips Bit



TOOLS AND HARDWARE REQUIRED FOR THIS PAGE



NO HARDWARE REQUIRED FOR THIS PAGE

SEC 2

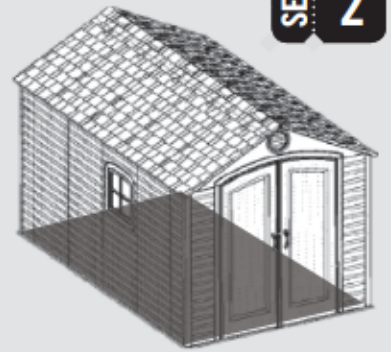

SEC

2.1

Add new **Center Floor Panel (AFX)**. Then, slide the rear section into place and connect the Floor Panels. You will need to tip the rear section forward slightly to connect the Center Floor Panels.

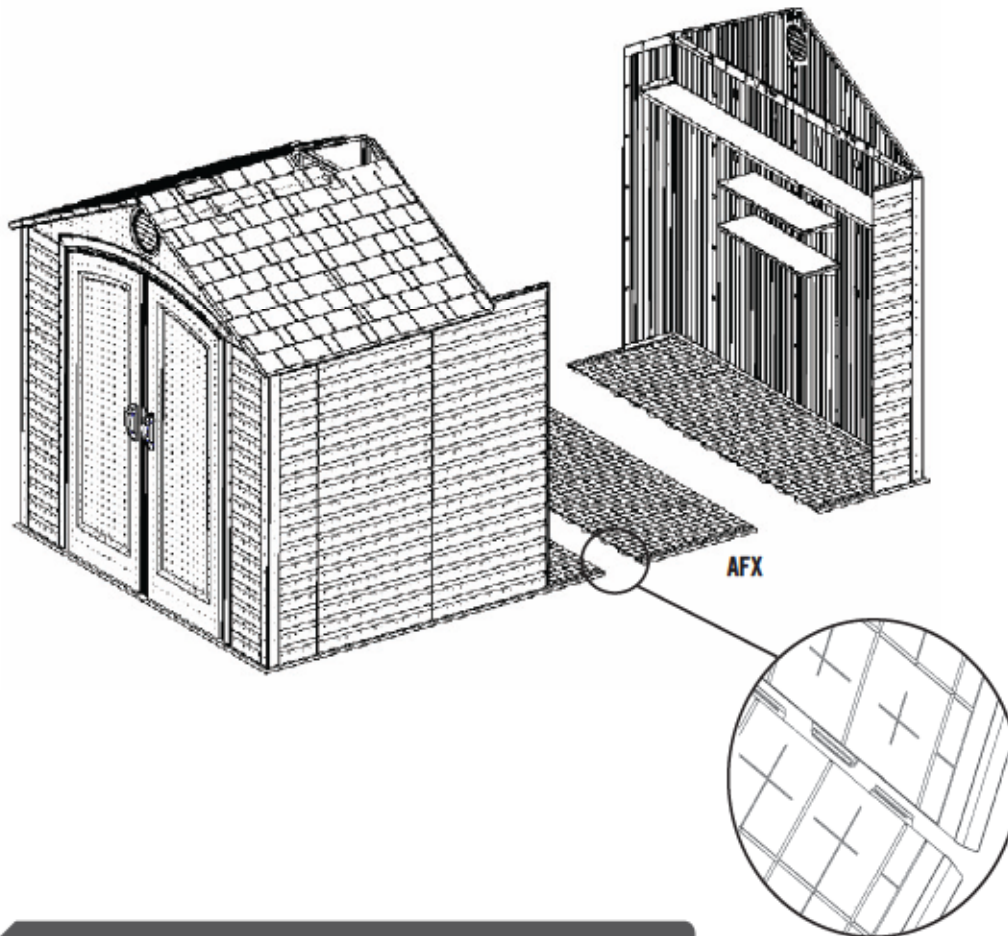

Note: Tip up one floor panel and line up tabs and then lay floor panel flat.



TOOLS AND HARDWARE REQUIRED FOR THIS PAGE



BQC (x8)

SEC 2

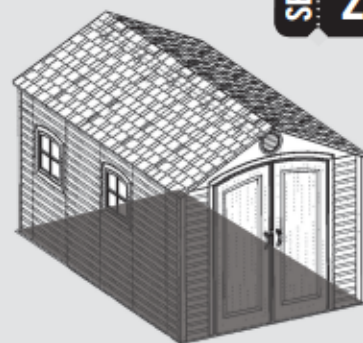

SEC

2.2

Face the seam of the two adjacent Floor Panels. Insert two (2) #8 x 1/2" Pan-Head Screws (BQC) near the seam of a Floor Panel and down into the tab of the adjacent Floor Panel at the locations shown. Repeat this step for the second seam.

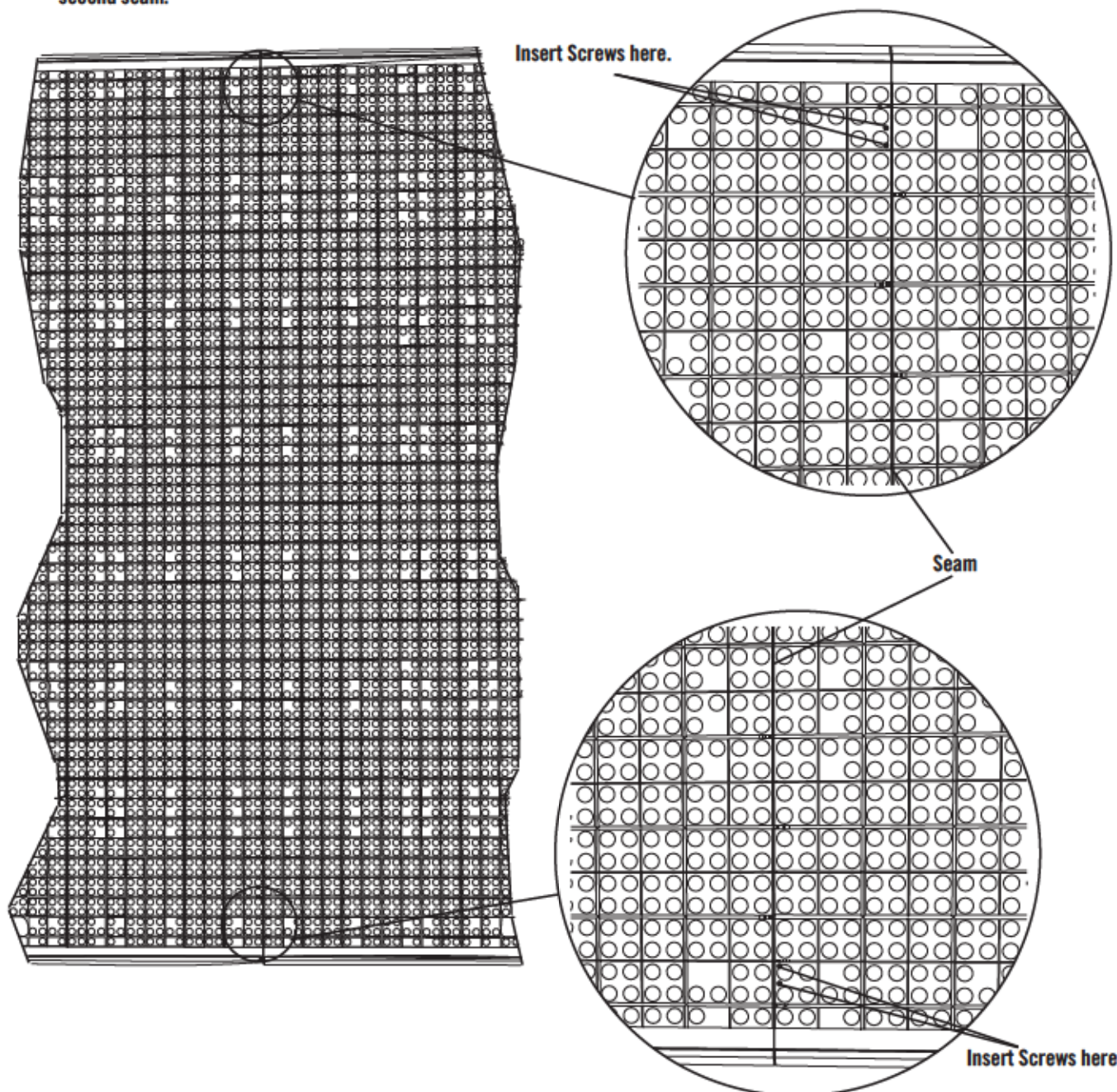

SEC 3 TRUSS ASSEMBLY

HARDWARE REQUIRED

HARDWARE BAG REQUIRED: BEA

Hardware shown at actual size



***AIP (x1)**
Truss Connector

Part shown at 50% of actual size

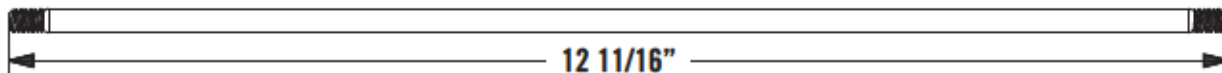

METAL PARTS REQUIRED

Parts shown at 8% of actual size (*Unless indicated otherwise)

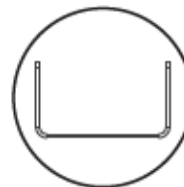
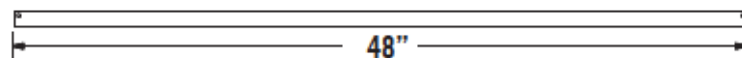
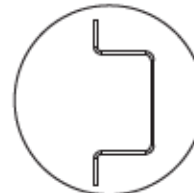
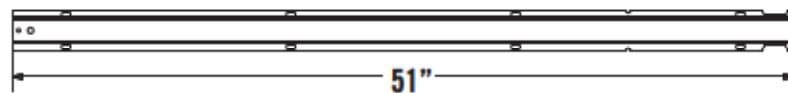

TOOLS REQUIRED

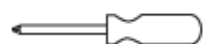

Phillips Screwdriver



7/16" Wrench



3/8" Wrench



Safety Glasses



TOOLS AND HARDWARE REQUIRED FOR THIS PAGE

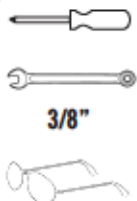

3/8"

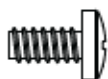

ADY (x1)



ADK (x1)

SEC 3

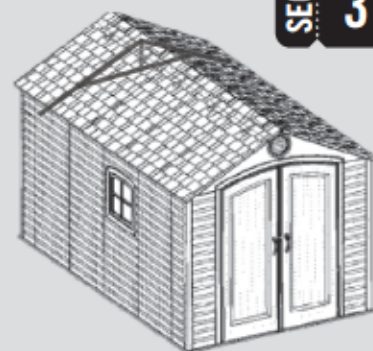

SEC

TRUSS ASSEMBLY

3.1

Stand a **Truss Gutter Channel (AFH)** upright and set a **Truss Connector (AIP)** inside the end of the Channel as shown. Align the holes and secure with one (1) #10 x 3/8" Pan-Head Screw (**ADY**) and one (1) #10 Cap Nut (**ADK**).

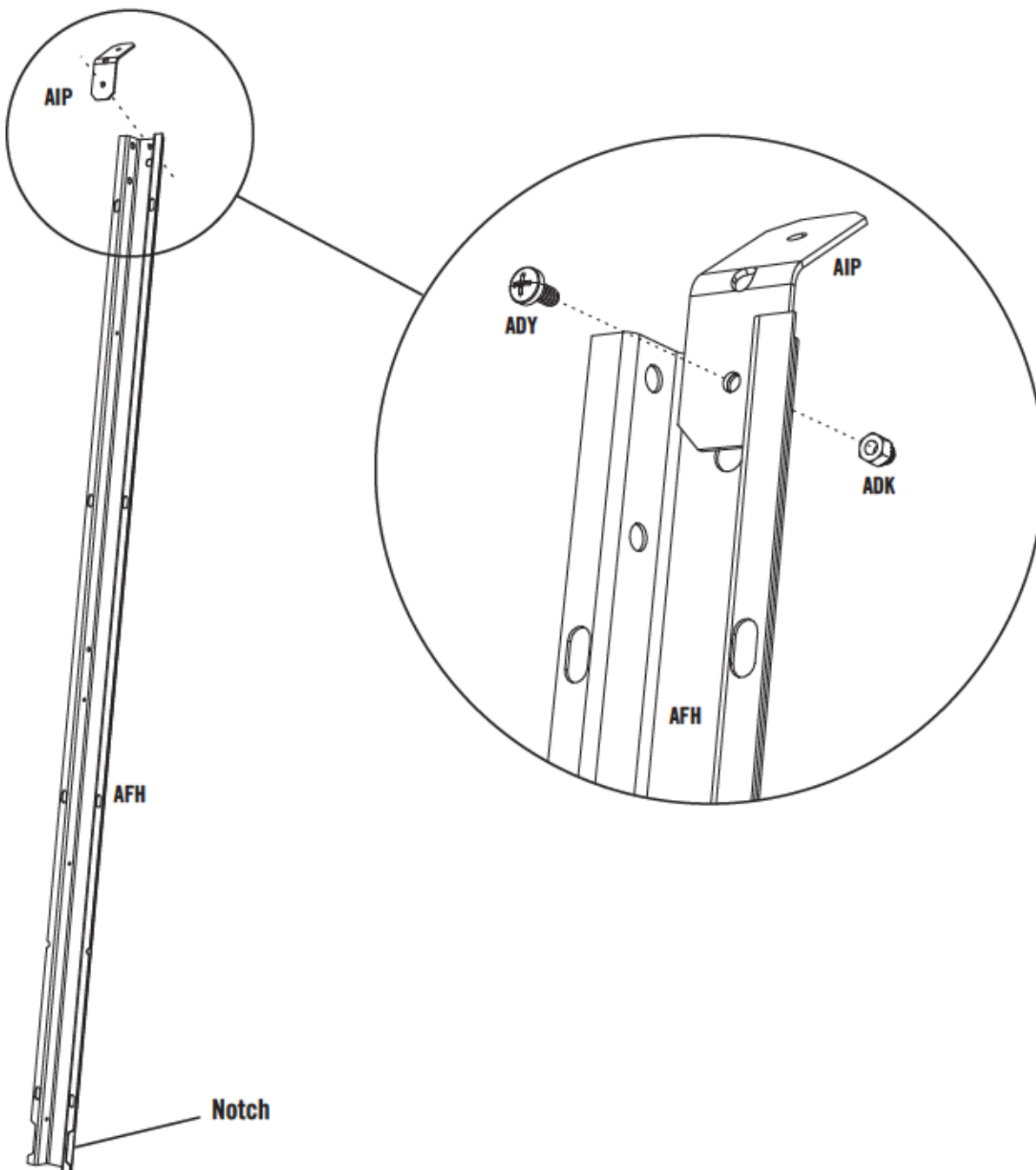



TOOLS AND HARDWARE REQUIRED FOR THIS PAGE



3/8"

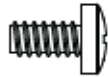

ADY (x1)



ADK (x1)

SEC 3



SEC

3.2

Connect another **Truss Gutter Channel (AFH)** to the Truss Connector using one (1) **#10 x 3/8" Pan-Head Screw (ADY)** and one (1) **#10 Cap Nut (ADK)**.

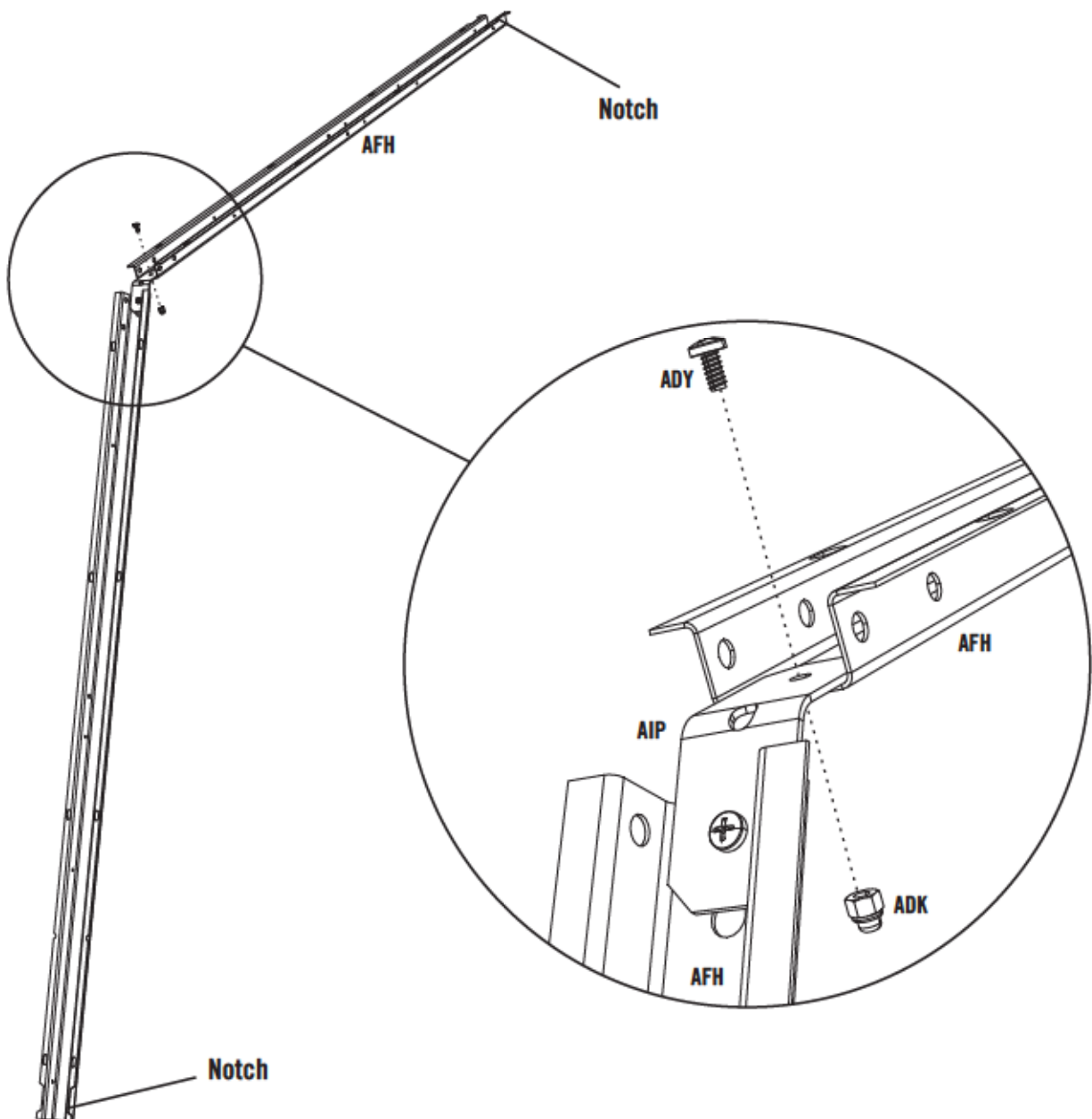



TOOLS AND HARDWARE REQUIRED FOR THIS PAGE



3/8"

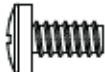

ADY (x4)



ADK (x4)

SEC 3



SEC

3.3

Lay the Truss Assembly on its side, and align the holes in a **Roof Truss Brace (AFG)** with those circled on the Truss Gutter Channels as shown.

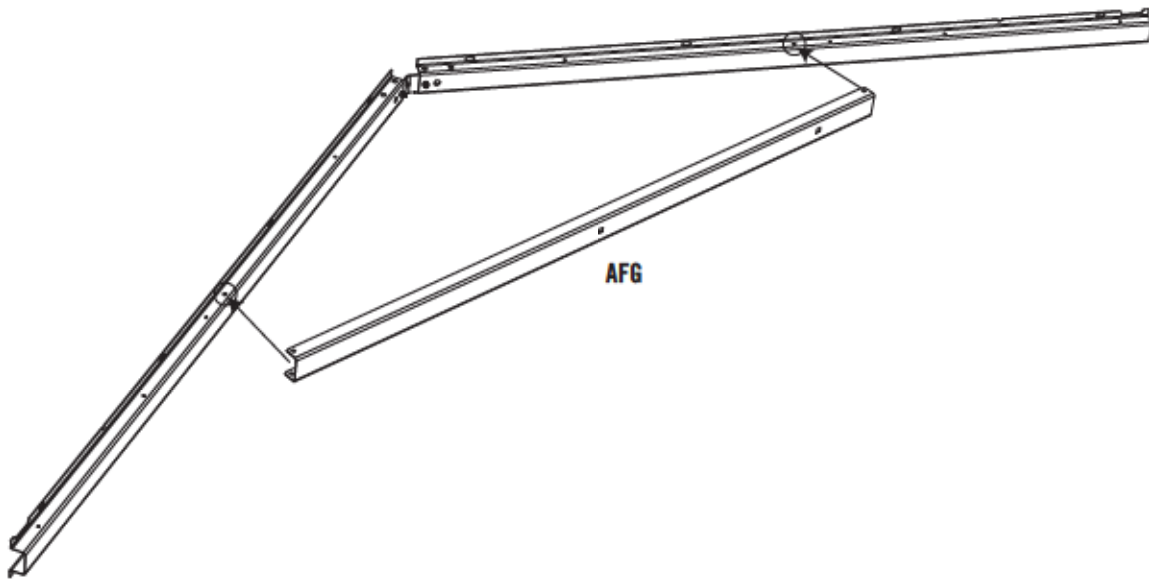

SEC

Secure the Roof Truss Brace to the Truss Gutter Channel using two (2) #10 x 3/8" Pan-Head Screws (ADY) and two (2) #10 Cap Nuts (ADK). Repeat this step for the other end of the Roof Truss Brace.

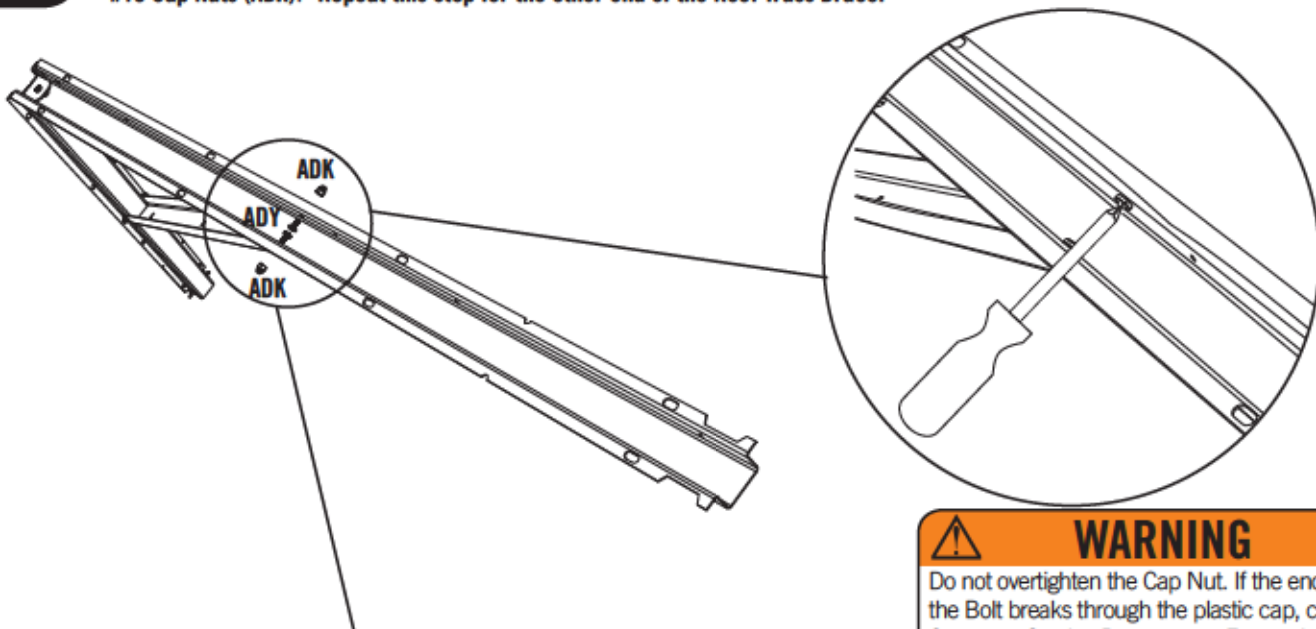

Note: The Cap Nuts goes on the outside of the Truss.



WARNING

Do not overtighten the Cap Nut. If the end of the Bolt breaks through the plastic cap, call our Customer Service Department. Exposed threads on the end of the Bolt may cause serious injuries.



TOOLS AND HARDWARE REQUIRED FOR THIS PAGE



7/16" (x2)



ADJ (x2)

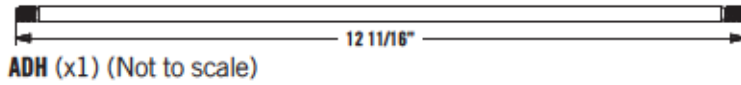

SEC 3

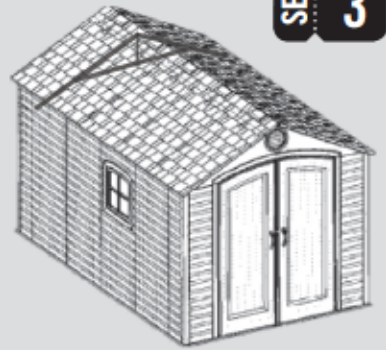

SEC

3.4

With the Truss Assembly on its side, slide a **1/4" Threaded Rod (ADH)** through the Roof Truss Brace and Truss Connector as shown. Secure the top and bottom of the 1/4" Threaded Rod with a **1/4" Cap Nut (ADJ)**. Tighten all hardware. The 1/4" Threaded Rod will still spin freely. Set aside.

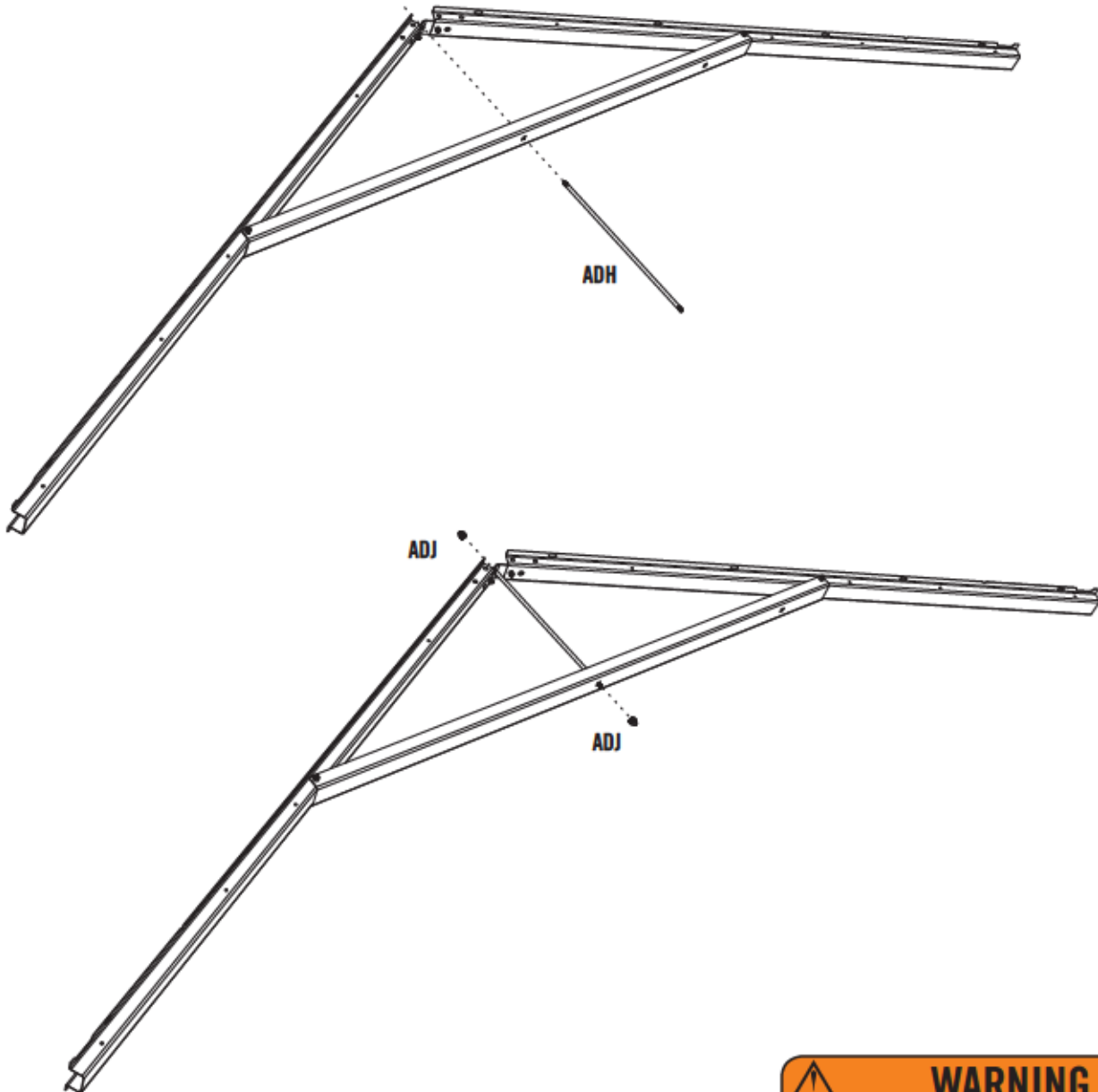

WARNING

Do not overtighten the Cap Nut.

SEC 4 WALL & ROOF INSTALLATION

HARDWARE REQUIRED

HARDWARE BAG REQUIRED: BGT

Hardware shown at of actual size



ADZ (x45)

1/4" x 5/8" Phillips Pan-Head Screw
(Not all screws will be used)

METAL PARTS REQUIRED

Parts shown at 8% of actual size



AFL (x2)

Roof Support Strip

PLASTIC PARTS REQUIRED

Parts shown at 4% of actual size

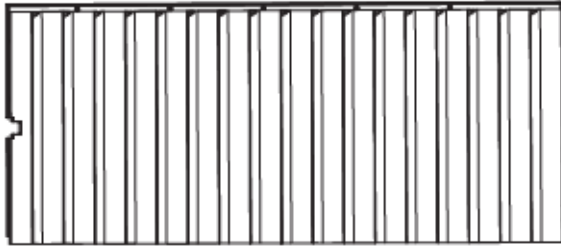

AHD (x2)

Wall Panel

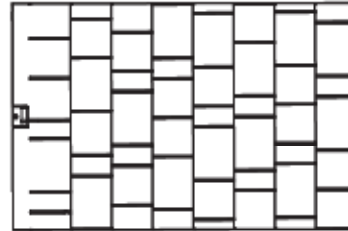

AGQ (x2)

Roof Panel

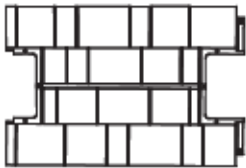

AFY (x1)

Center Roof Cap

TOOLS REQUIRED



Phillips Screwdriver



Safety Glasses



TOOLS AND HARDWARE REQUIRED FOR THIS PAGE

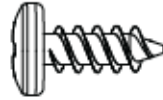

ADZ (x10)

SEC 4

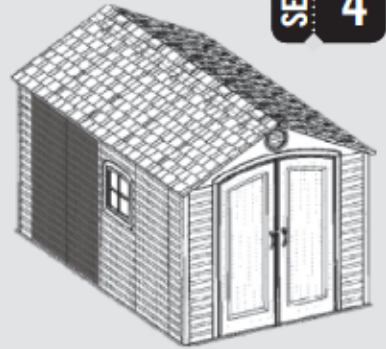

USE THE 1/4" X 5/8" PHILLIPS PAN-HEAD SCREWS YOU REMOVED IN SECTION 1 TO HELP COMPLETE THE ASSEMBLY ON THIS PAGE

SEC

4.1

Secure new **Wall Panels (AHD)**, along with the Panels you removed, to the Shed using the Screws you removed from the Shed during disassembly and the **1/4" x 5/8" Phillips Pan-Head Screws (ADZ)** furnished with this kit.

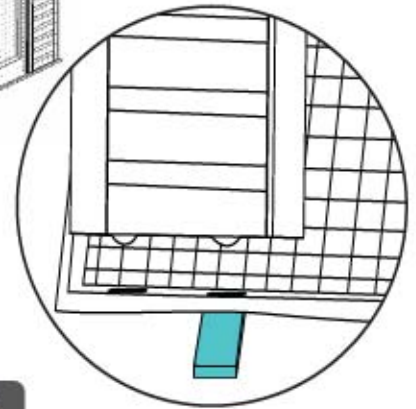
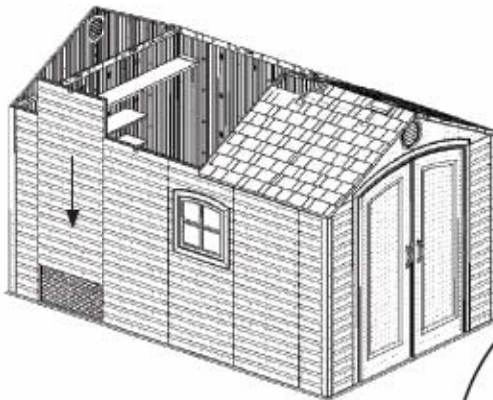
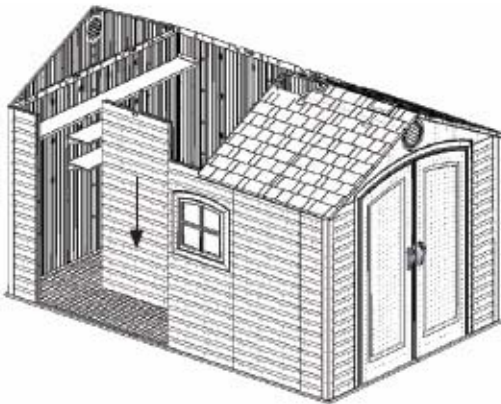
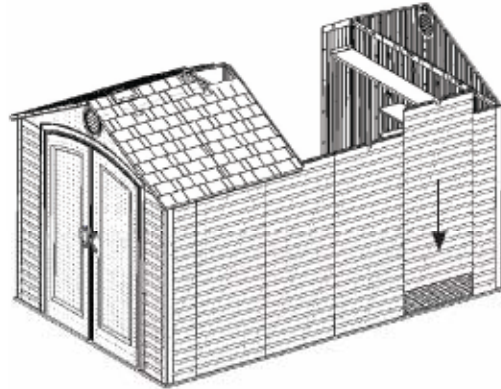
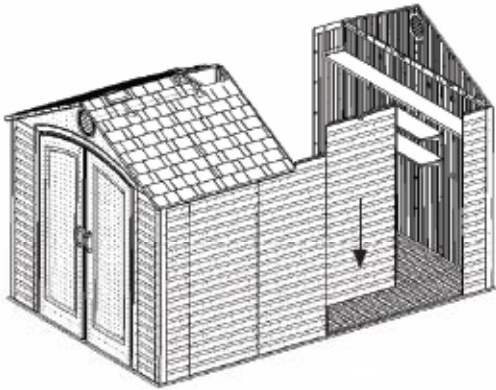

Note: Insert a wood block directly under the tab you want to insert, then slide block to next tab and repeat.



TOOLS AND HARDWARE REQUIRED FOR THIS PAGE

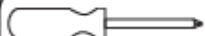

NO NEW HARDWARE REQUIRED FOR THIS PAGE

SEC 4

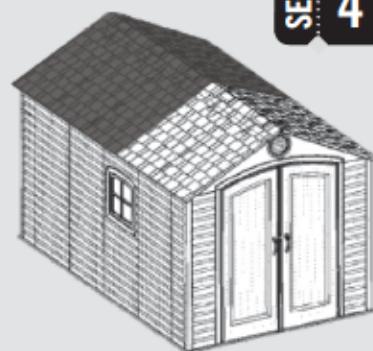

USE THE 1/4" X 5/8" PHILLIPS PAN-HEAD SCREWS YOU REMOVED IN SECTION 1 TO HELP COMPLETE THE ASSEMBLY ON THIS PAGE

SEC

4.2

Install the Truss Assembly you removed in Section 1.

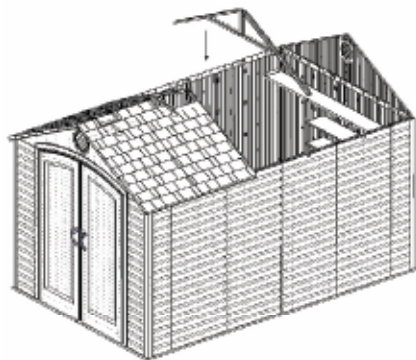

SEC

4.3

While one adult holds the Truss Assembly in place, attach the Roof Panels and Roof Support Strips you removed in Section 1.

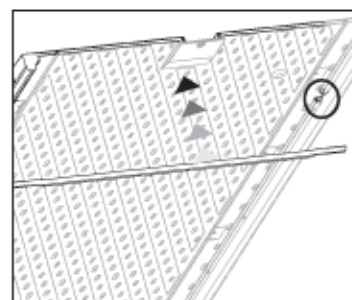
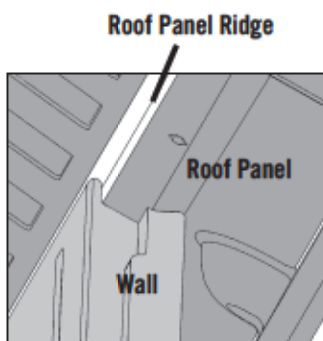
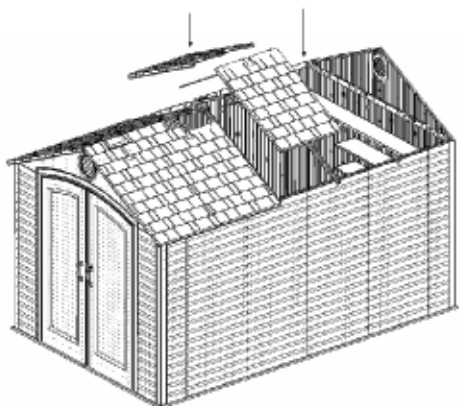



TOOLS AND HARDWARE REQUIRED FOR THIS PAGE

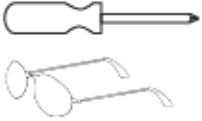

NO NEW HARDWARE REQUIRED FOR THIS PAGE

SEC 4

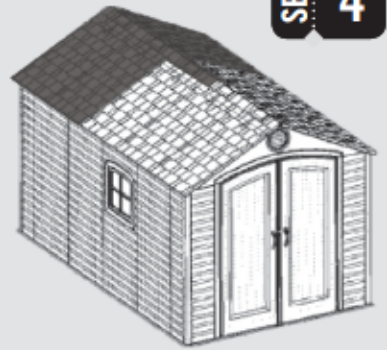

USE THE 1/4" X 5/8" PHILLIPS PAN-HEAD SCREWS YOU REMOVED IN SECTION 1 TO HELP COMPLETE THE ASSEMBLY ON THIS PAGE

SEC 4.4

Attach a Center Roof Cap you removed in Section 1.

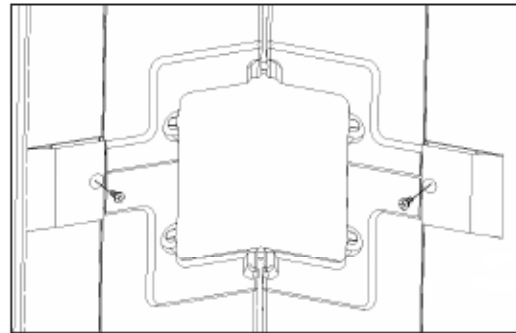
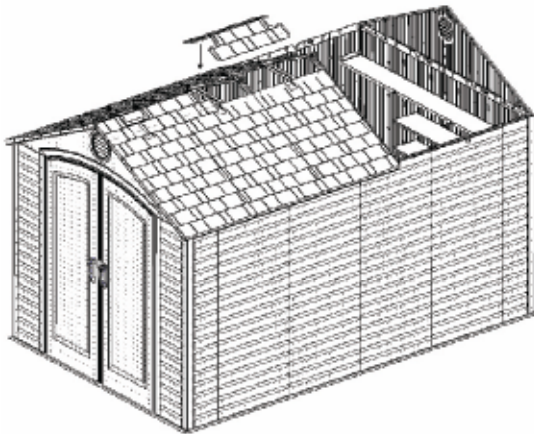

SEC 4.5

Install the Truss Assembly you assembled in Section 3.

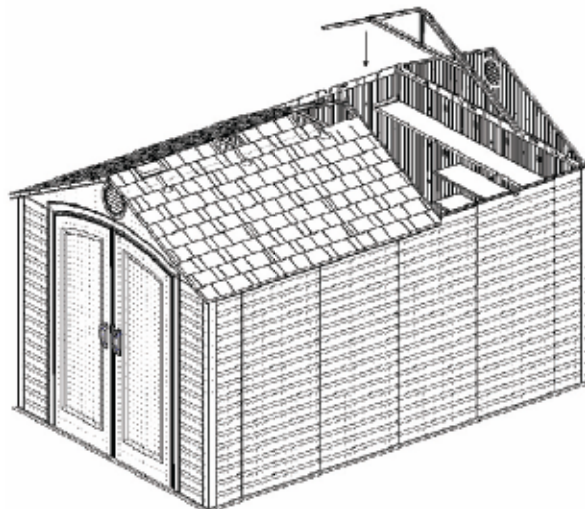



TOOLS AND HARDWARE REQUIRED FOR THIS PAGE

SEC 4

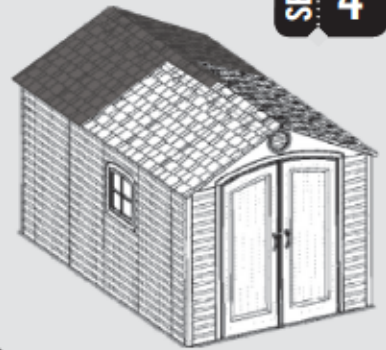

USE THE 1/4" X 5/8" PHILLIPS PAN-HEAD SCREWS YOU REMOVED IN SECTION 1 TO HELP COMPLETE THE ASSEMBLY ON THIS PAGE

SEC

4.6

Install the **Roof Panels (AGQ)** and **Roof Support Strips (AFL)** using the hardware furnished with this kit.

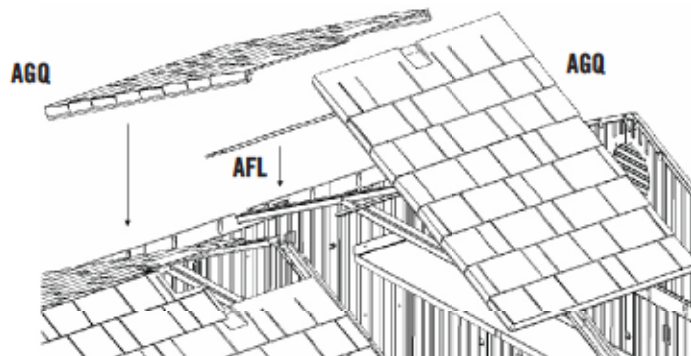

SEC

4.7

Install a **Center Roof Cap** you removed in Section 1 using the hardware from Section 1.

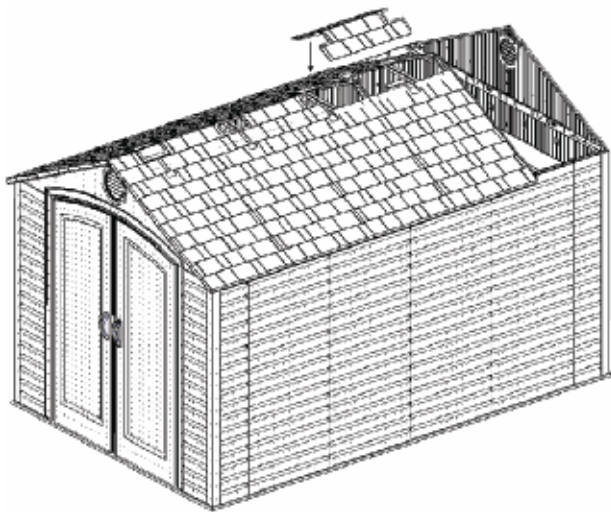

SEC

4.8

Install the **Roof Panels and Roof Support Strips** you removed in Section 1 using the hardware from Section 1.

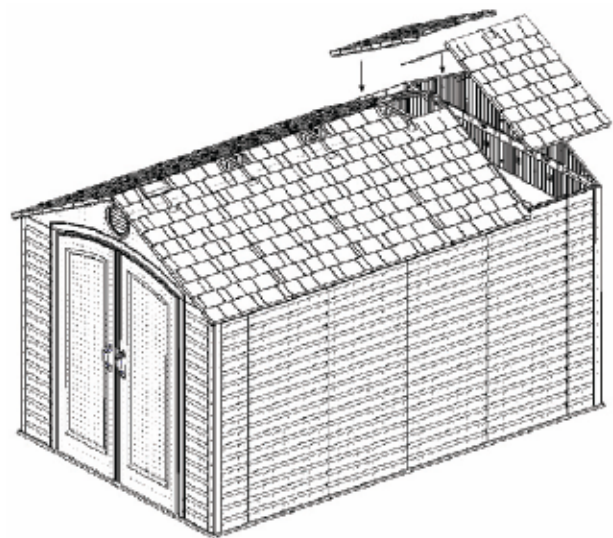



TOOLS AND HARDWARE REQUIRED FOR THIS PAGE

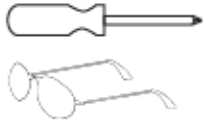

ADZ (x6)

SEC 4

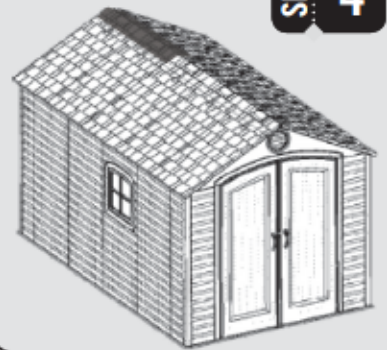

USE THE 1/4" X 5/8" PHILLIPS PAN-HEAD SCREWS, THE #10 X 1/2" PHILLIPS PAN-HEAD SCREWS, AND THE #10 X 1" FENDER WASHERS YOU REMOVED IN SECTION 1 TO HELP COMPLETE THE ASSEMBLY ON THIS PAGE

SEC

4.9

Install the **Center Roof Cap (AFY)** furnished with this kit and the End Roof Cap you removed in Section 1 using the hardware you removed in Section 1 and the hardware furnished with this kit.

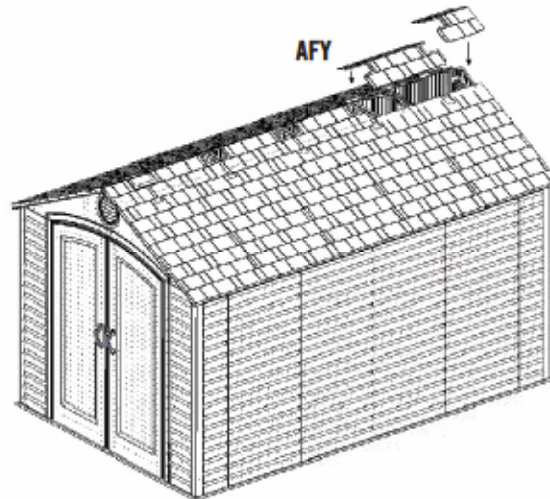

SEC 5 SKYLIGHT INSTALLATION

HARDWARE REQUIRED

HARDWARE BAG REQUIRED: BGS

Hardware shown at of actual size



ADX (x6)
#10 x 1/2" Phillips Pan-Head Screw

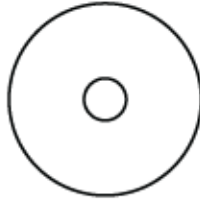

AED (x6)
#10 x 1" Fender Washer

PLASTIC PARTS REQUIRED

Part shown at 8% of actual size



AHC (x1)
Skylight

TOOLS REQUIRED



Phillips Screwdriver



Safety Glasses



TOOLS AND HARDWARE REQUIRED FOR THIS PAGE

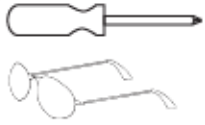

ADX (x6)

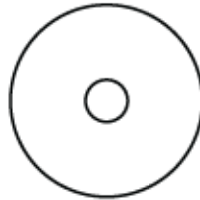

AED (x6)

SEC 5

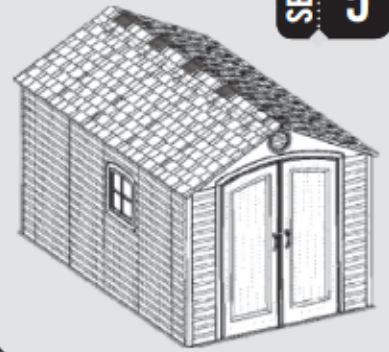

SEC

5.1

Install the Skylights you removed in Section 1 and the **Skylight (AHC)** furnished with this kit using the required hardware.

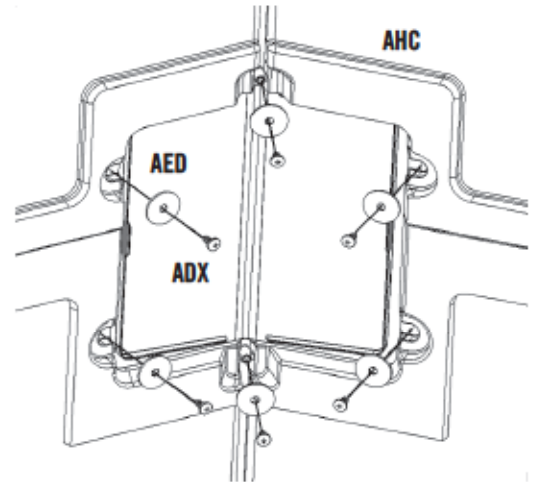
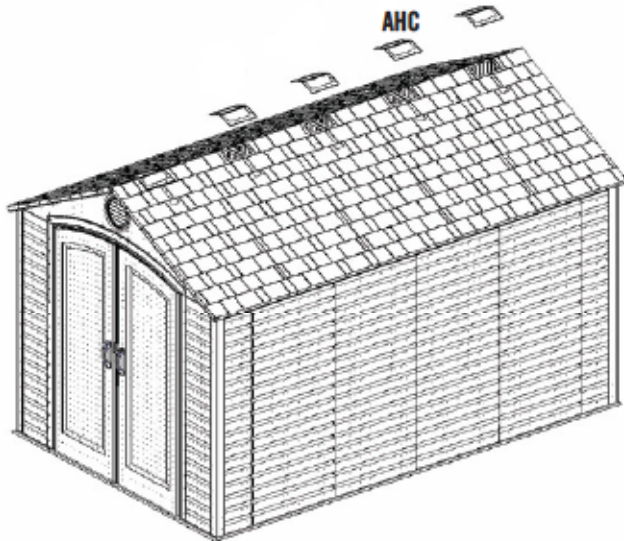

LIFETIME OUTDOOR SHED EQUIPMENT

10-YEAR LIMITED FACTORY WARRANTY

THE MANUFACTURER RESERVES THE RIGHT TO MAKE SUBSTITUTIONS TO WARRANTY CLAIMS IF PARTS ARE UNAVAILABLE OR OBSOLETE.

1. Lifetime outdoor sheds are warranted to the original purchaser to be free from defects in material or workmanship for a period of ten years from the date of original retail purchase. The word "defects" is defined as imperfections that impair the use of the product. Defects resulting from misuse, abuse or negligence will void this warranty. This warranty does not cover defects due to improper installation, alteration or accident. This warranty does not cover damage caused by vandalism, rusting, "acts of nature" or any other event beyond the control of the manufacturer.
2. This warranty is nontransferable and is expressly limited to the repair or replacement of defective product. If the product is defective within the terms of this warranty, Lifetime Products, Inc. will repair or replace defective parts at no cost to the purchaser. Shipping charges to and from the factory or distribution center are not covered and are the responsibility of the purchaser. Labor charges and related expenses for removal, installation or replacement of the shed or its components are not covered under this warranty.
3. This warranty does not cover scratching or scuffing of the product that may result from normal usage. In addition, defects resulting from intentional damage, negligence, unreasonable use or hanging from the truss will void this warranty.
4. Liability for incidental or consequential damages is excluded to the extent permitted by law. While every attempt is made to embody the highest degree of safety in all equipment, freedom from injury cannot be guaranteed. The user assumes all risk of injury resulting from the use of this product. All merchandise is sold on this condition, and no representative of the company may waive or change this policy.
5. This product is not intended for institutional or commercial use; Lifetime Products, Inc. does not assume any liability for such use. Institutional or commercial use will void the warranty.
6. This warranty is expressly in lieu of all other warranties, expressed or implied, including warranties of merchantability or fitness for use to extent permitted by Federal and state law. Neither Lifetime Products, Inc., nor any representative assumes any other liability in connection with this product. This warranty gives you specific legal rights, and you may also have other rights which vary from state to state.

PLEASE INCLUDE YOUR DATED SALES RECEIPT AND PHOTOGRAPHS OF DAMAGED PARTS.

REPORT PRODUCT DEFECTS IN WRITING TO:

Lifetime Products, Inc., PO Box 160010 Clearfield, UT 84016-0010
or call 1-800-225-3865 M-F 7 a.m. to 5 p.m. MST.

REGISTER YOUR PRODUCT FOR QUICKER CUSTOMER SERVICE.

Visit www.lifetime.com or call 1-800-225-3865 to register your product today.

FOR INTERNATIONAL WARRANTY CLAIMS:

All warranty claims must be accompanied by a sales receipt. Report all warranty claims in writing to your regional sales support representative. Please include your dated sales receipt and photographs of damaged parts.

To identify the representative for your region — Please visit: www.lifetime.com/international



www.lifetime.com

ENHANCE YOUR LIFETIME® PURCHASE BY ADDING ACCESSORIES OR OTHER GREAT PRODUCTS

To purchase accessories or other Lifetime Products, visit us at:

www.lifetime.com

Or call: 1-800-424-3865

