

# SOJAG

produits saisonniers • seasonal products

Sojag code: 312-8162868

CUP/UPC code: 772830162868

QUESTIONS? 1 866-901-1649

## Assembly Manual / Guide d'assemblage / Manual de ensamblaje / 조립 설명서 / Montageanleitung

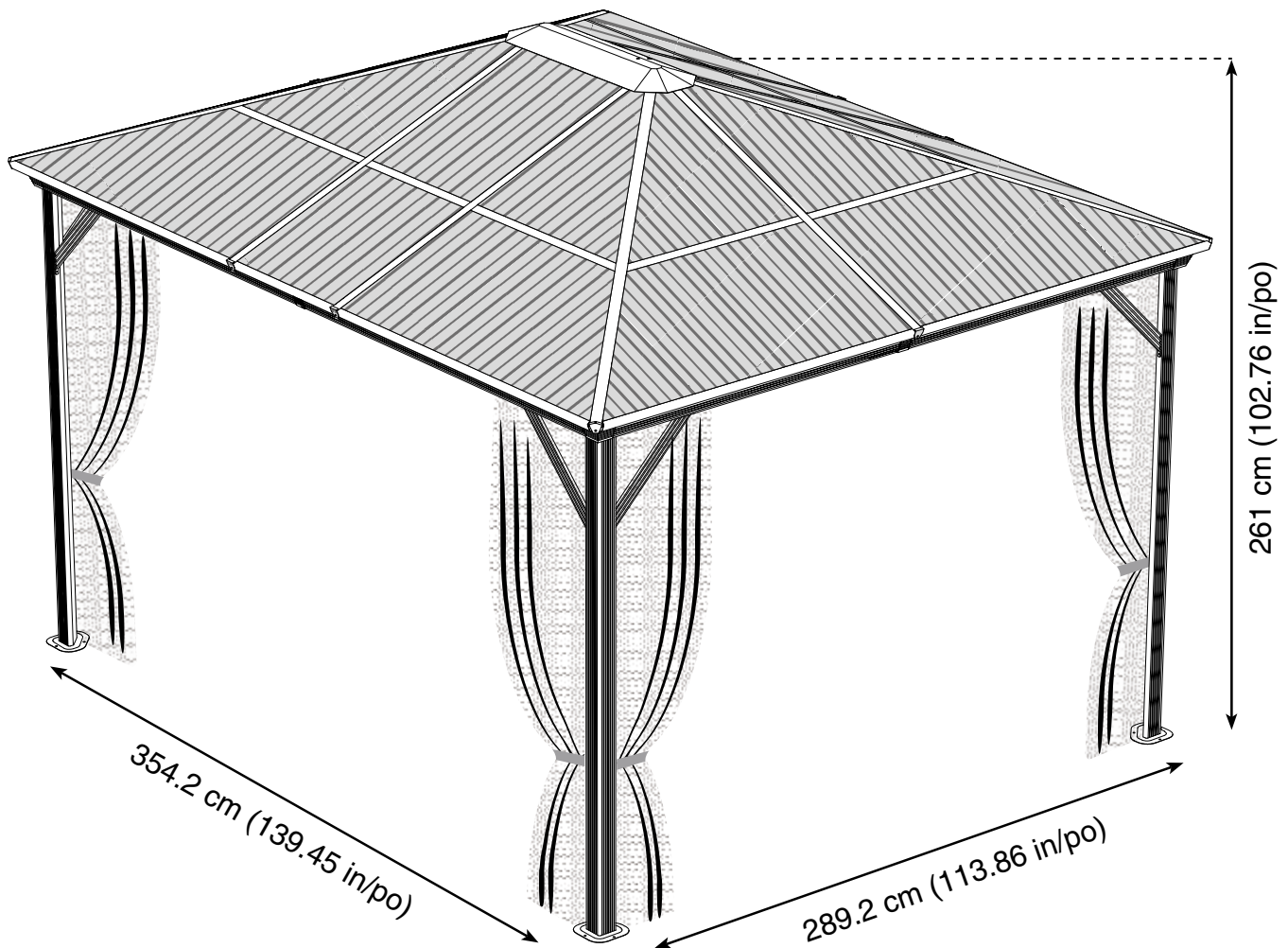

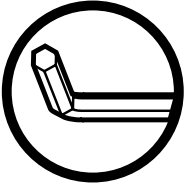

Use the hex keys in the box. / Utilisez les clés hexagonales fournies dans la boîte. /  
Utilice las llaves hexagonales en la caja. / 상자에 육각 키를 사용 하십시오. / Verwenden Sie  
die Sechskantschlüssel in der Box.

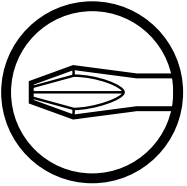

Please use a Phillips screwdriver. / Utilisez un tournevis de type Phillips / Por favor,  
use un destornillador Phillips. / 십자 드라이버를 사용 하십시오. / Bitte verwenden  
Sie einen Kreuzschraubenzieher.



You may need to use a drill for this step. / Vous pouvez avoir besoin d'utiliser une  
perceuse pour cette étape. / Puede que tenga que utilizar un taladro para este paso. /  
이 단계에선 드릴을 사용해야 할 수도 있습니다. / Für diesen Schritt können Sie einen  
Bohrer verwenden.



Wearing protective gloves is recommended. / Le port de gants de protection est recommandé /  
El uso de guantes de protección se recomienda. / 보호 장갑을 착용 하는 것이 좋습니다. /  
Das Tragen von Schutzhandschuhen wird empfohlen.



Two or more people are required at this stage. / Deux personnes ou plus sont nécessaires à cette  
étape. / Dos o más personas se requieren en esta etapa. / 이 단계에서는 두 명 이상 이 필요합니다. /  
Für diesen Bauschritt sind 2 oder mehr Personen erforderlich.



Do not tighten screws all the way for now. / Ne pas visser fermement pour l'instant. /  
No atornille con firmeza por ahora. / 아직 나사를 단단히 조이지 마십시오. / Bitte die  
Schrauben zum jetzigen Zeitpunkt noch nicht fest anziehen.



Sold separately. / Vendus séparément. / vendido en las opciones. /  
옵션 판매 / Optional erhältlich

**T** X 8 (+2)

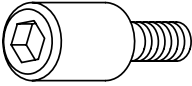

**U** X 16 (+2)

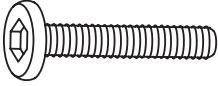

**U1** X 1 (+1)

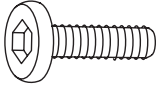

**U2** X 2 (+1)

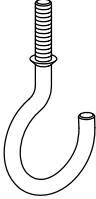

**V** X 64 (+7)

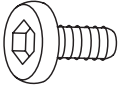

**V1** X 16 (+2)

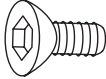

**V2** X 20 (+2)

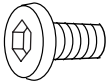

**W** X 24 (+3)

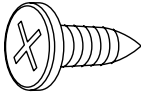



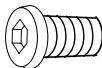



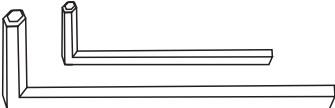

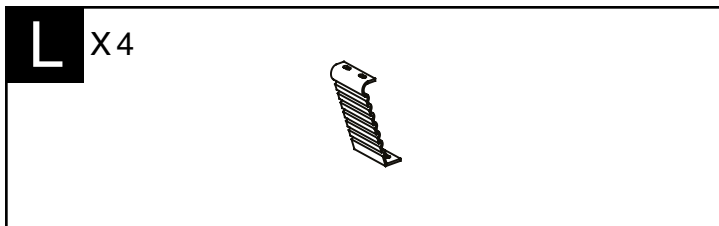
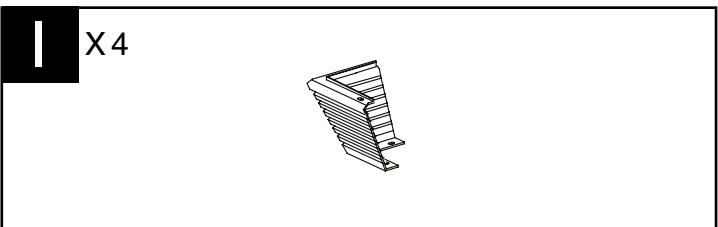
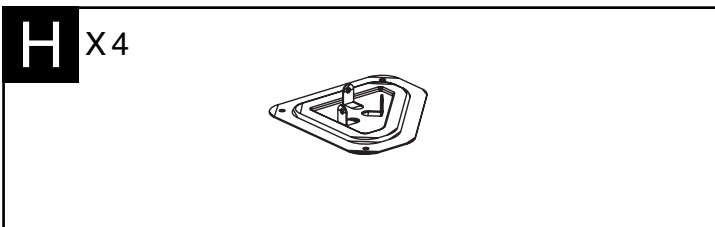
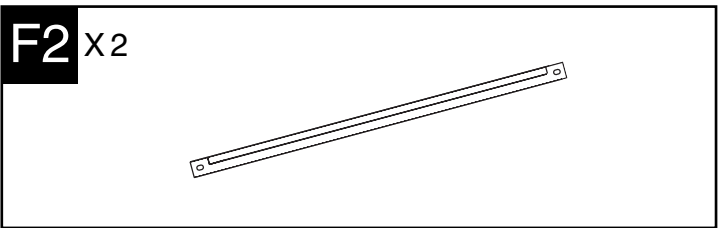
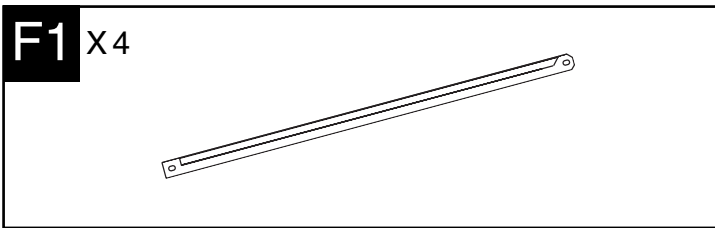
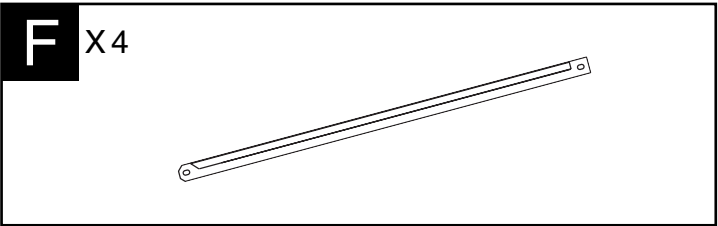
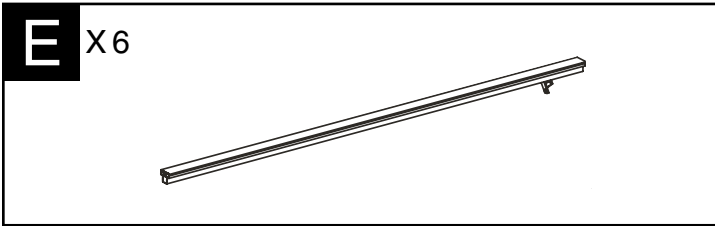
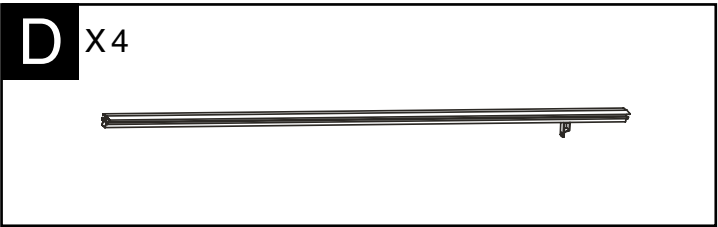
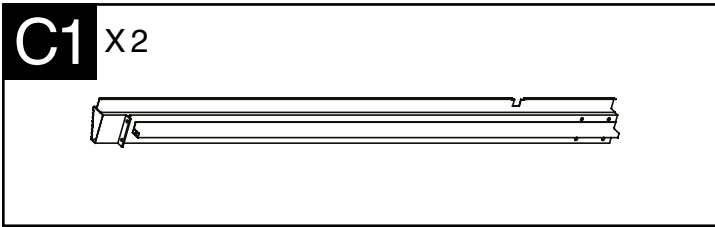
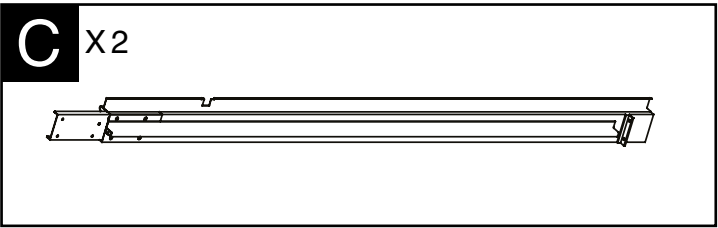
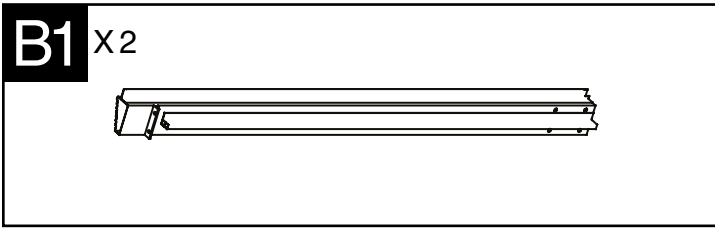
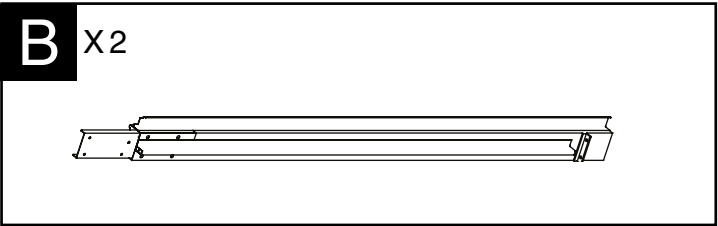
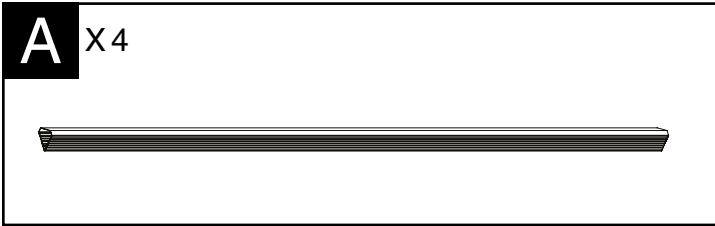

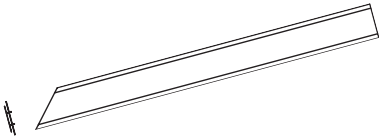
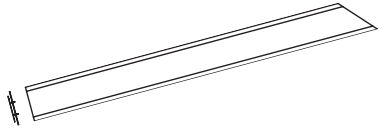
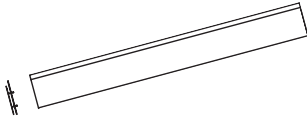
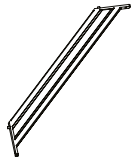
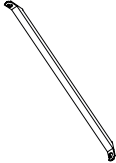

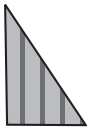
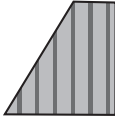
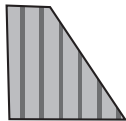
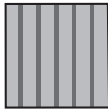
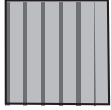
**W1** X 16 (+2)

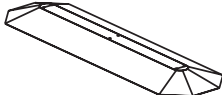
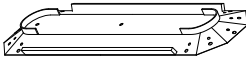

**Y** X 1

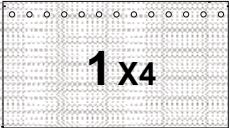

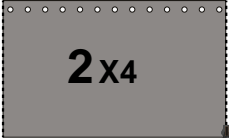

<b>J</b> X4 	<b>J1</b> X4 	
<b>J2</b> X2 	<b>K</b> X8 	
<b>K2</b> X4 	<b>Ma</b> X4 	
<b>Na</b> X4 	<b>Mb</b> X4 	
<b>Nb</b> X4 	<b>Z</b> X2 	<b>Z1</b> X2 
<b>Q</b> X4 	<b>R</b> X6 	<b>S</b> X1 
<b>S1</b> X1 	<b>X</b> X52 optional   <b>X</b> X52 optional 	
<b>Net</b>  <b>1</b> X4  optional	<b>Curtain</b>  <b>2</b> X4  optional	

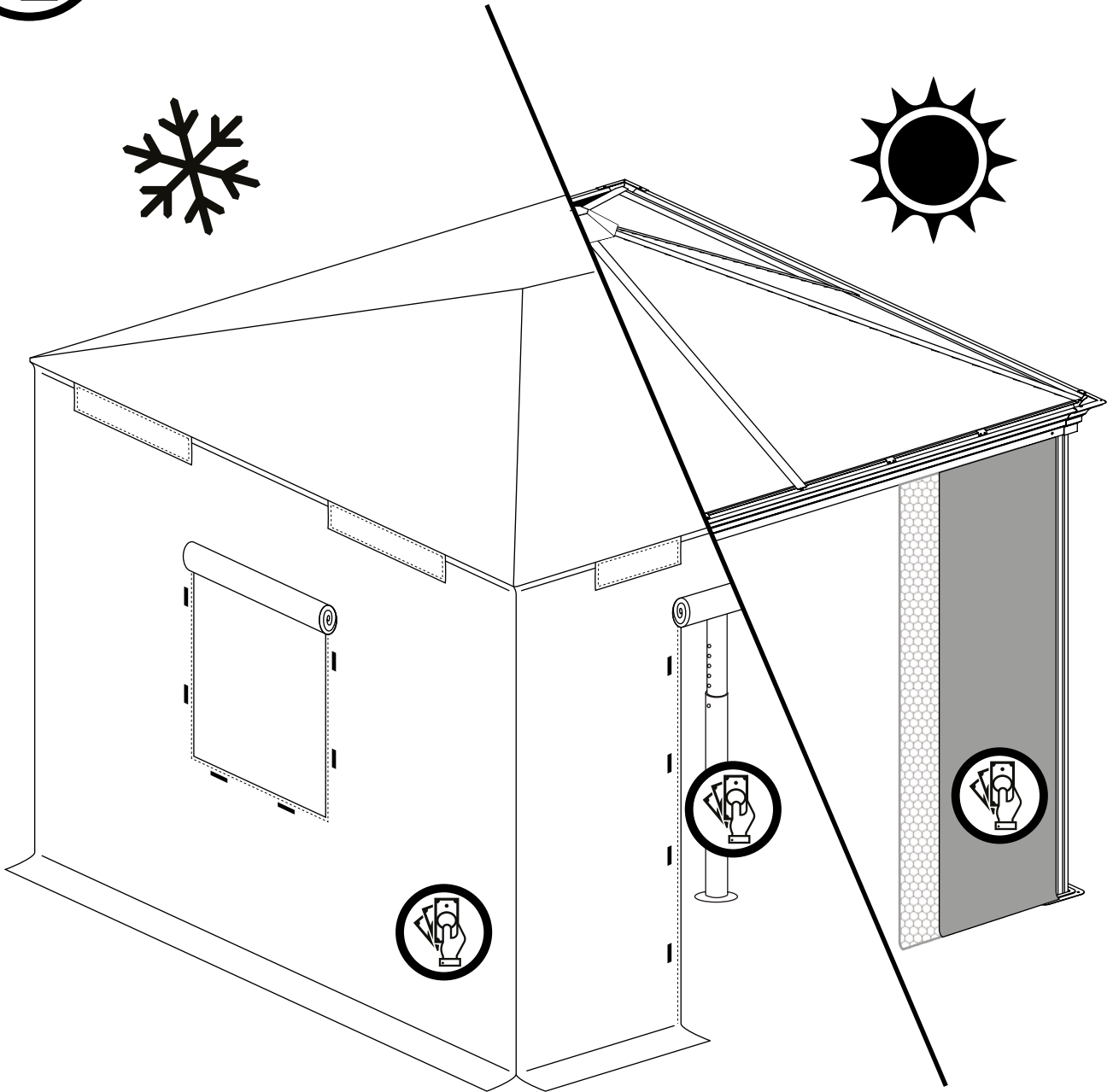
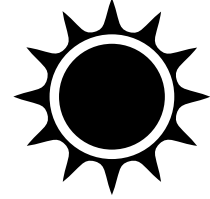
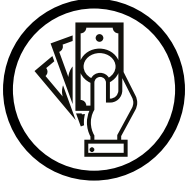

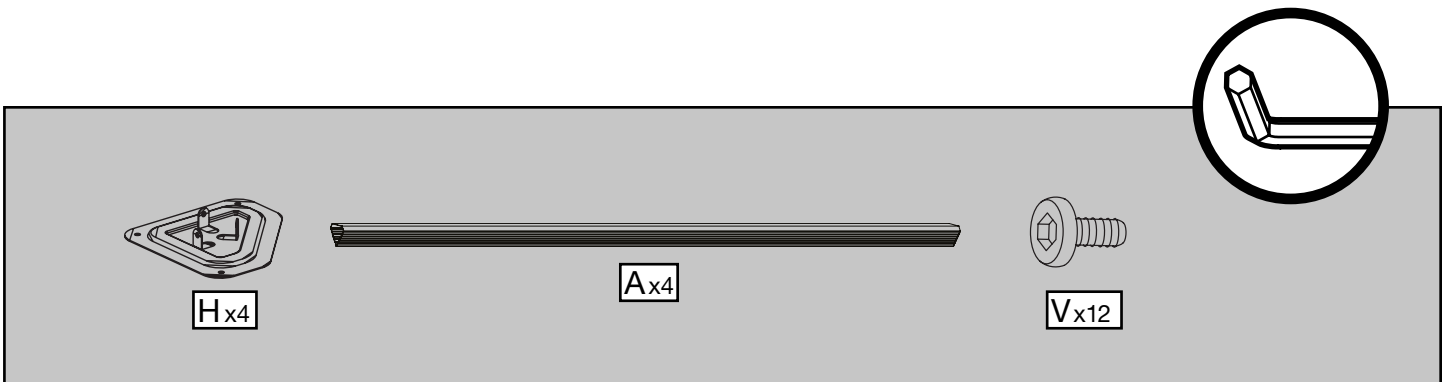
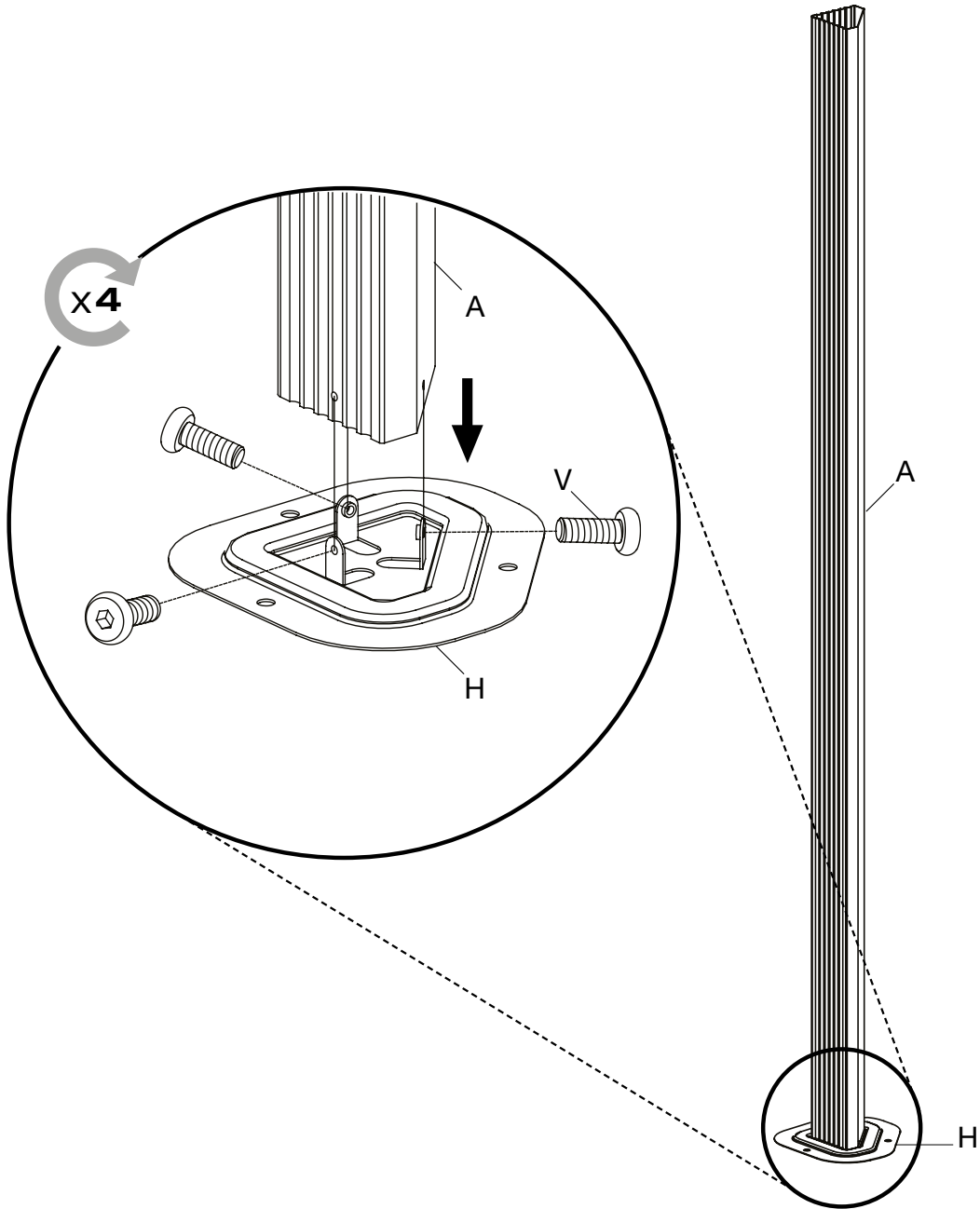

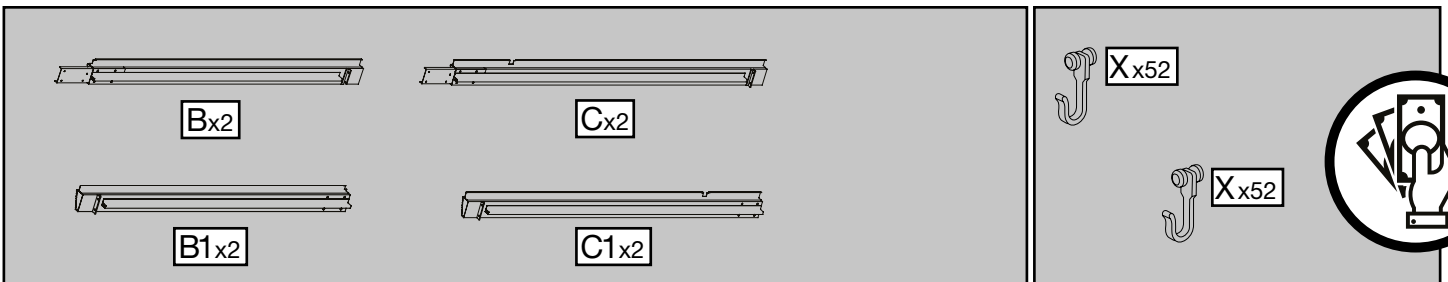
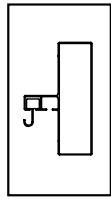
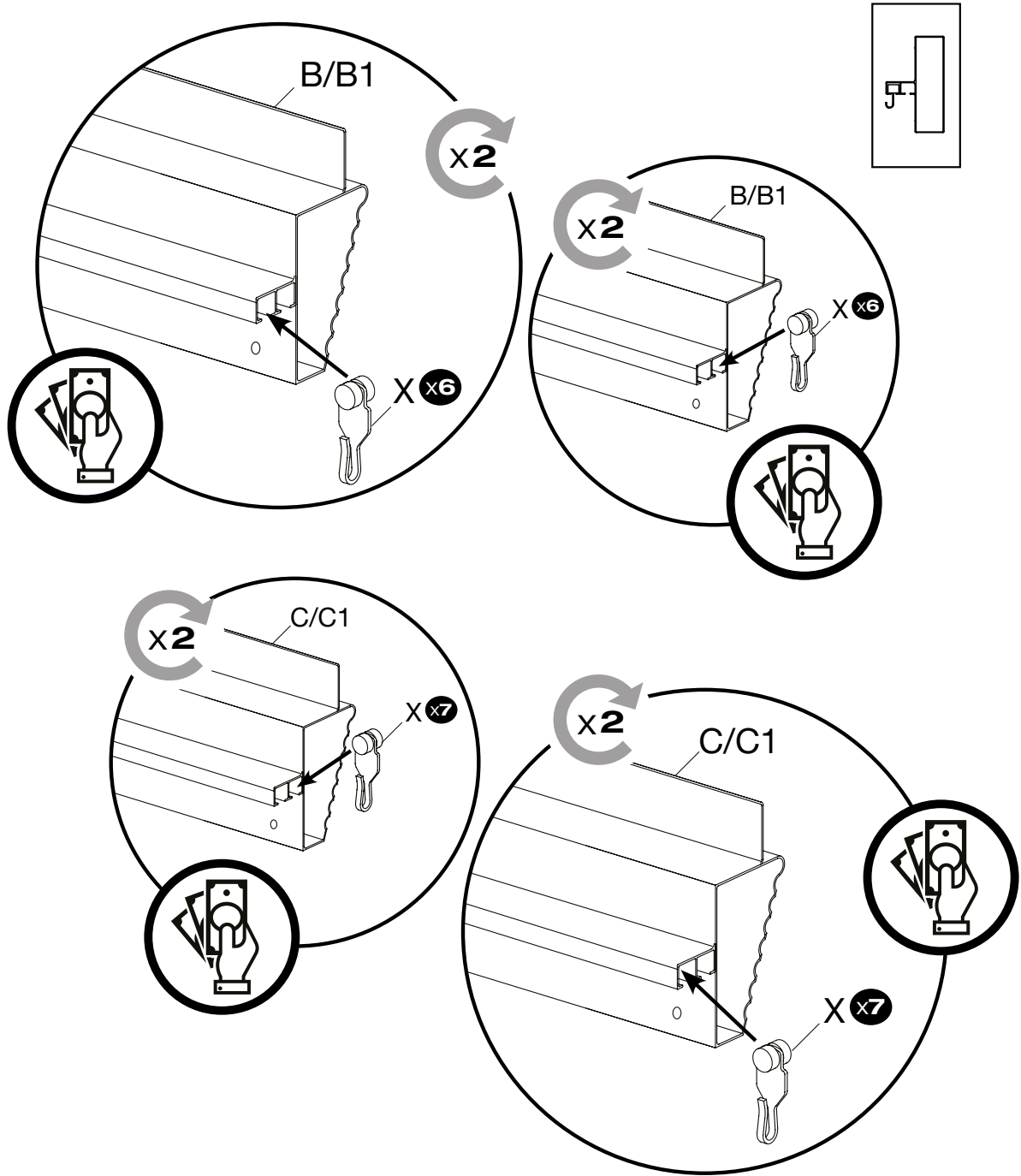



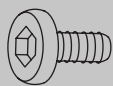
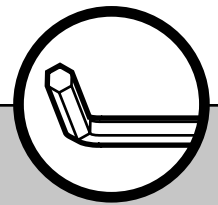
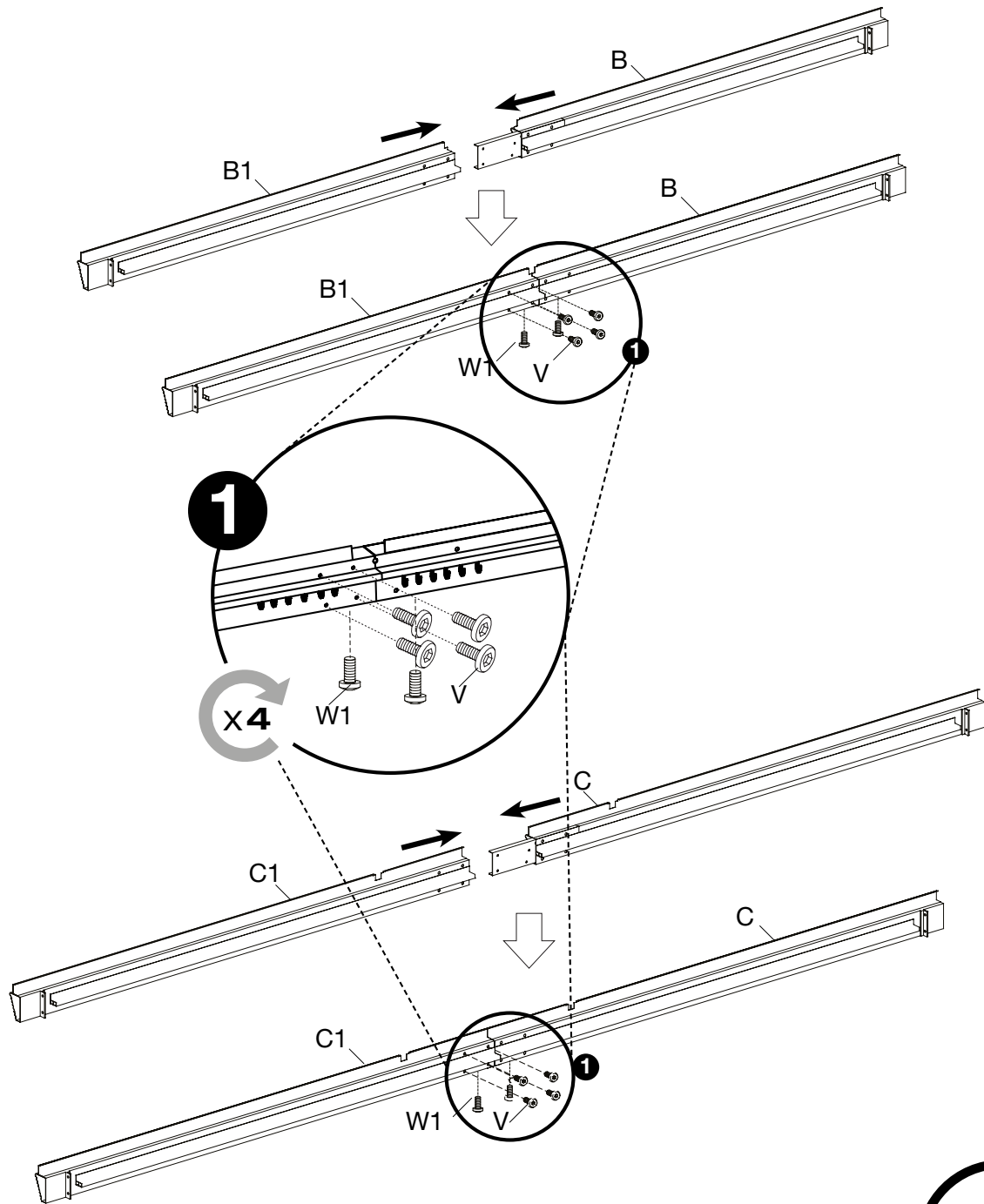

Vx16



W1x8

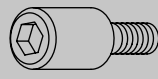
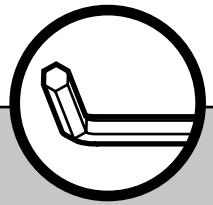
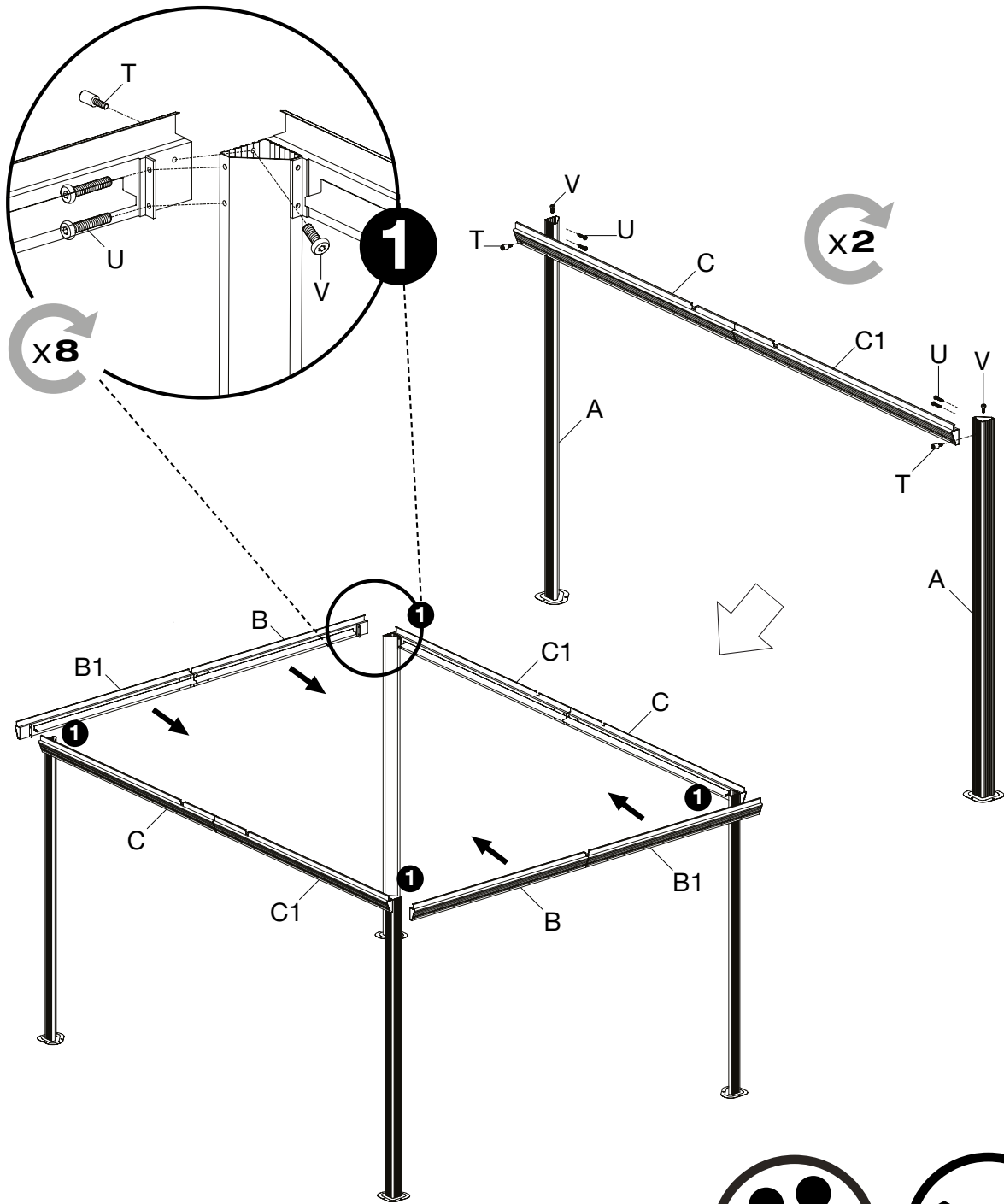

Tx8

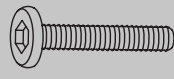

Ux16



Vx8

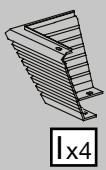
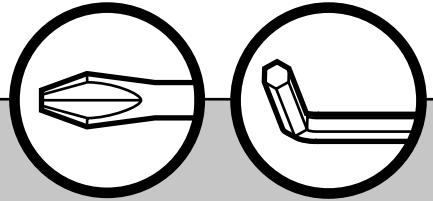
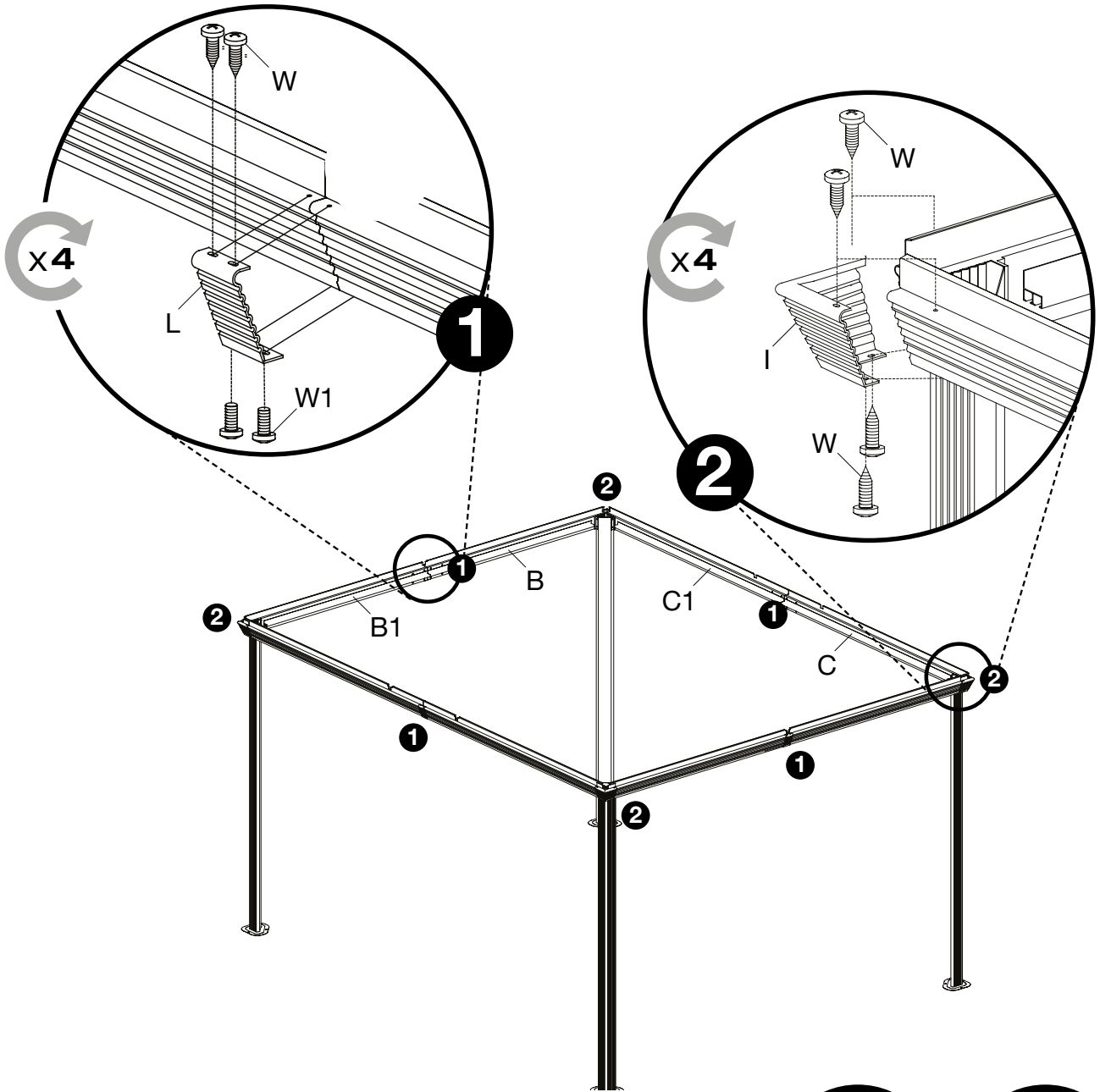

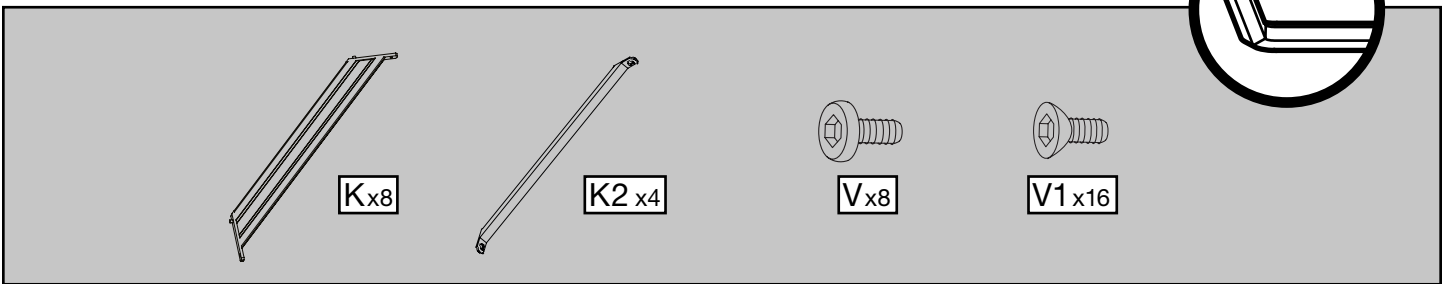
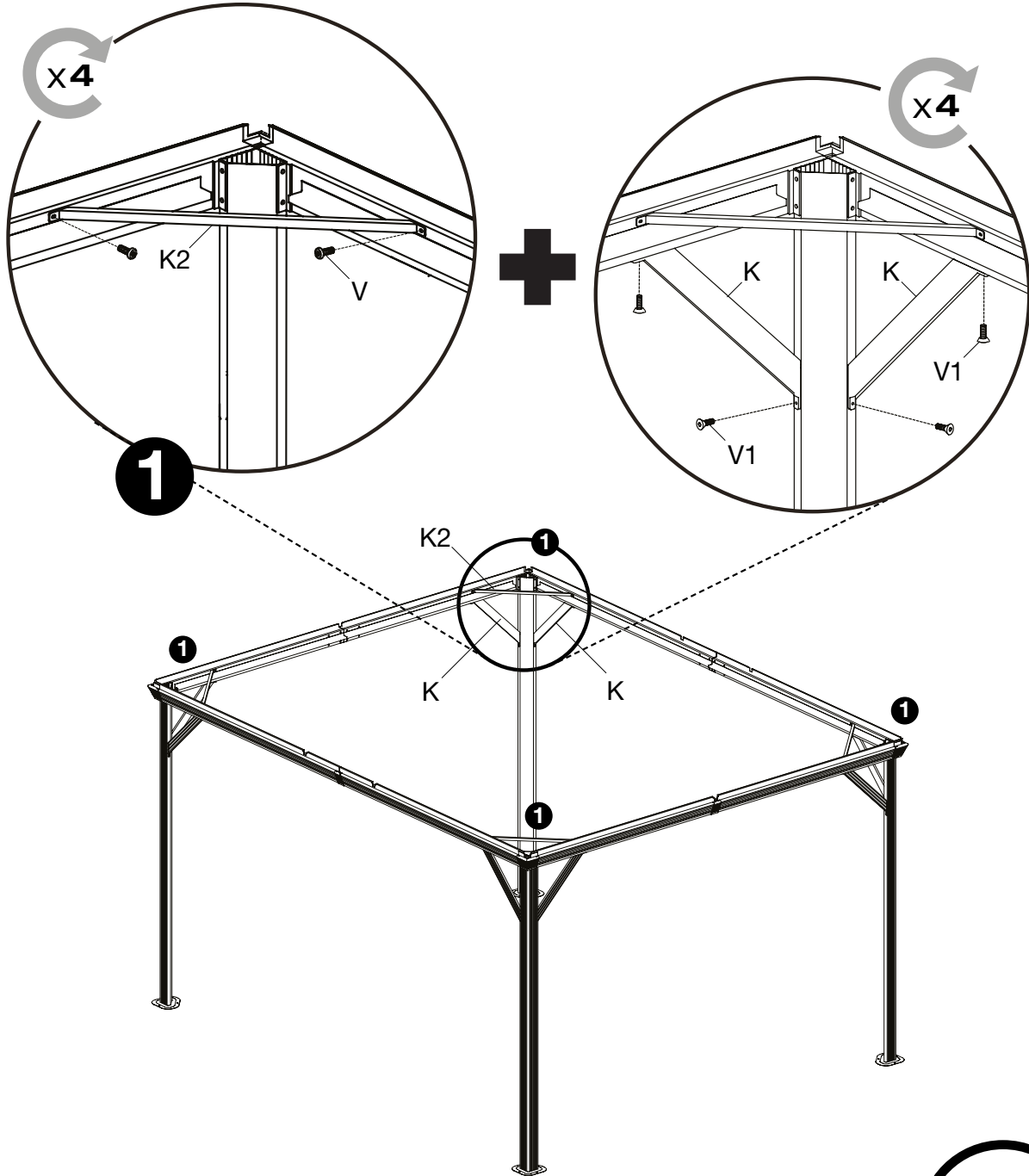

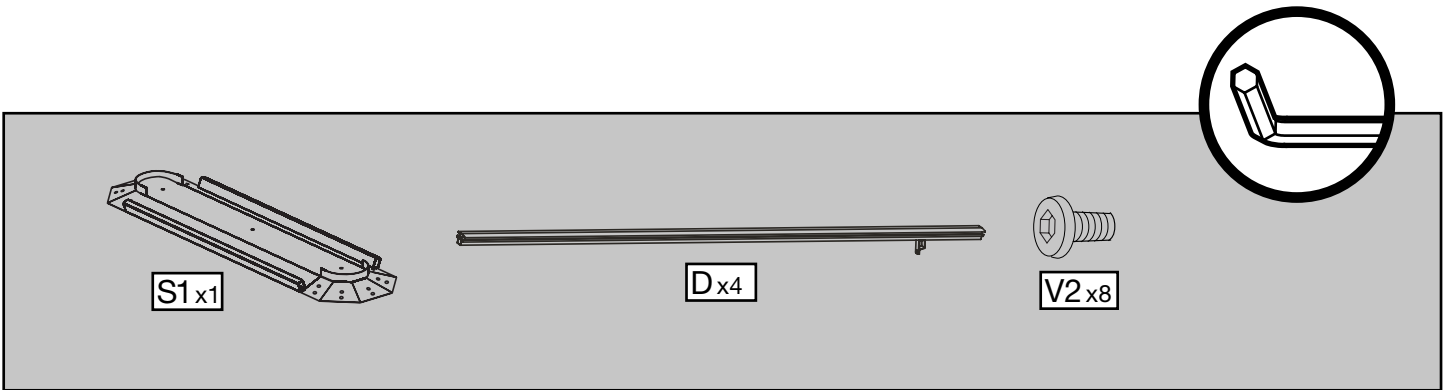
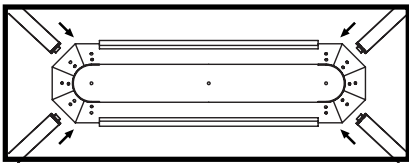
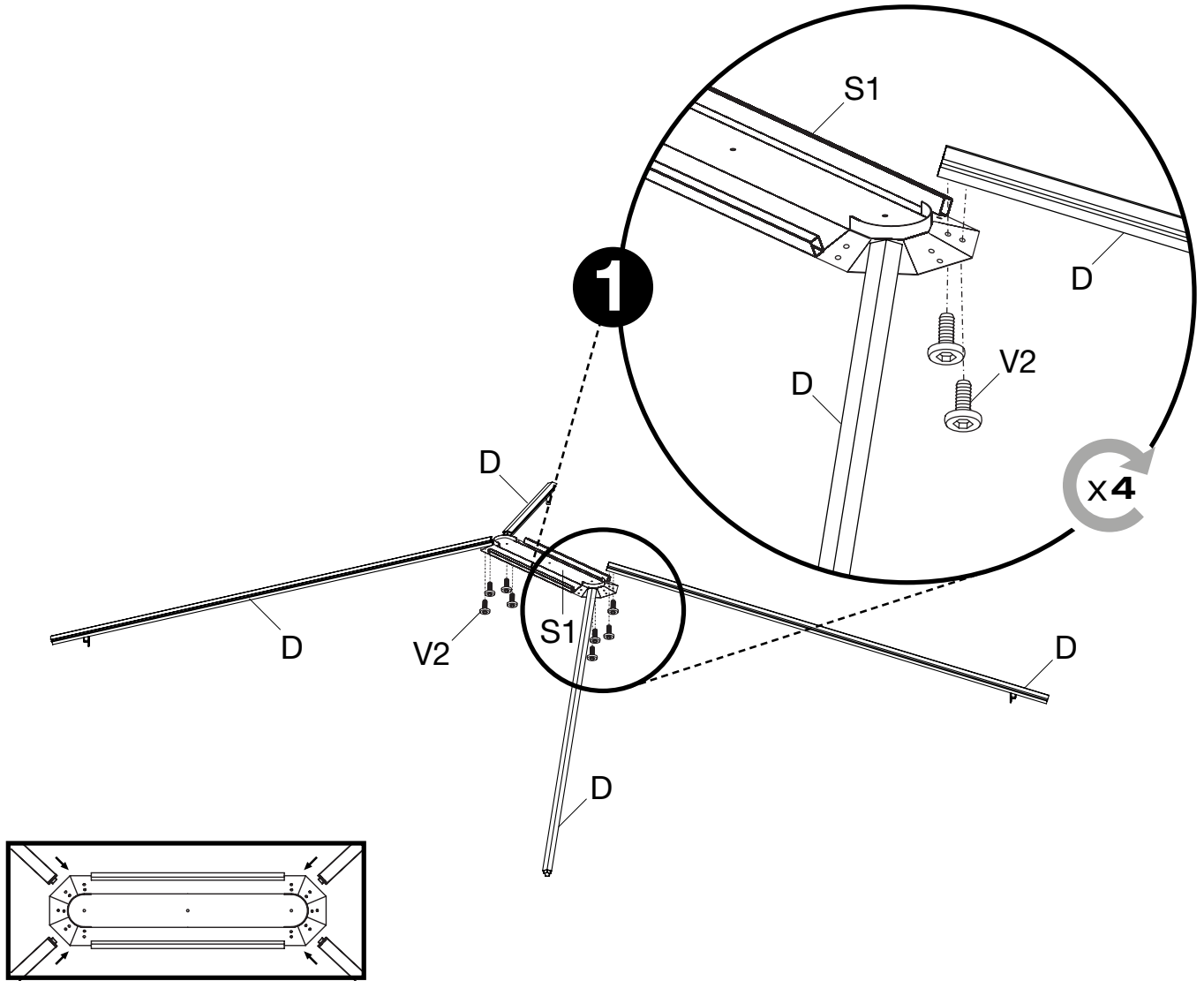

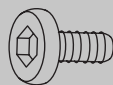
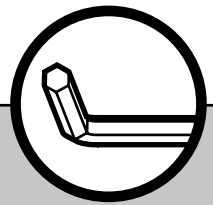
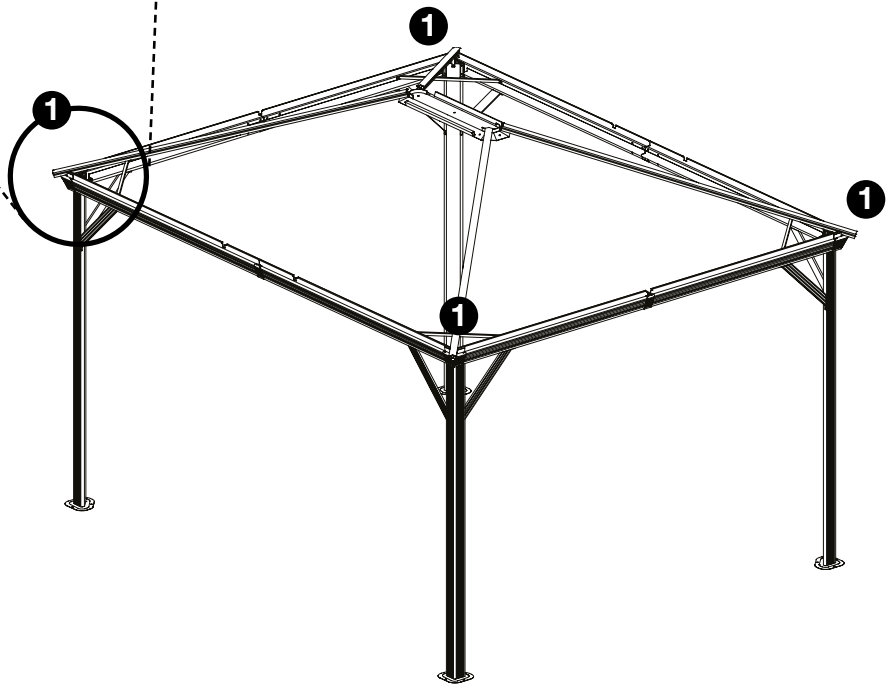
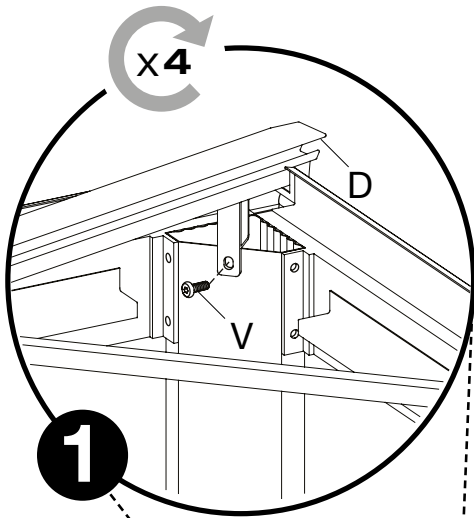

Vx4

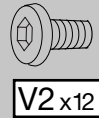
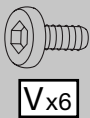
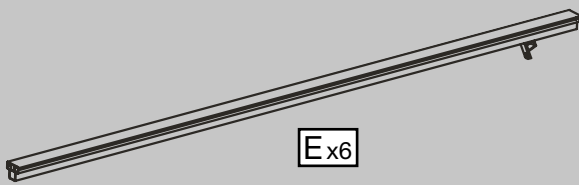
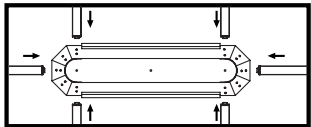
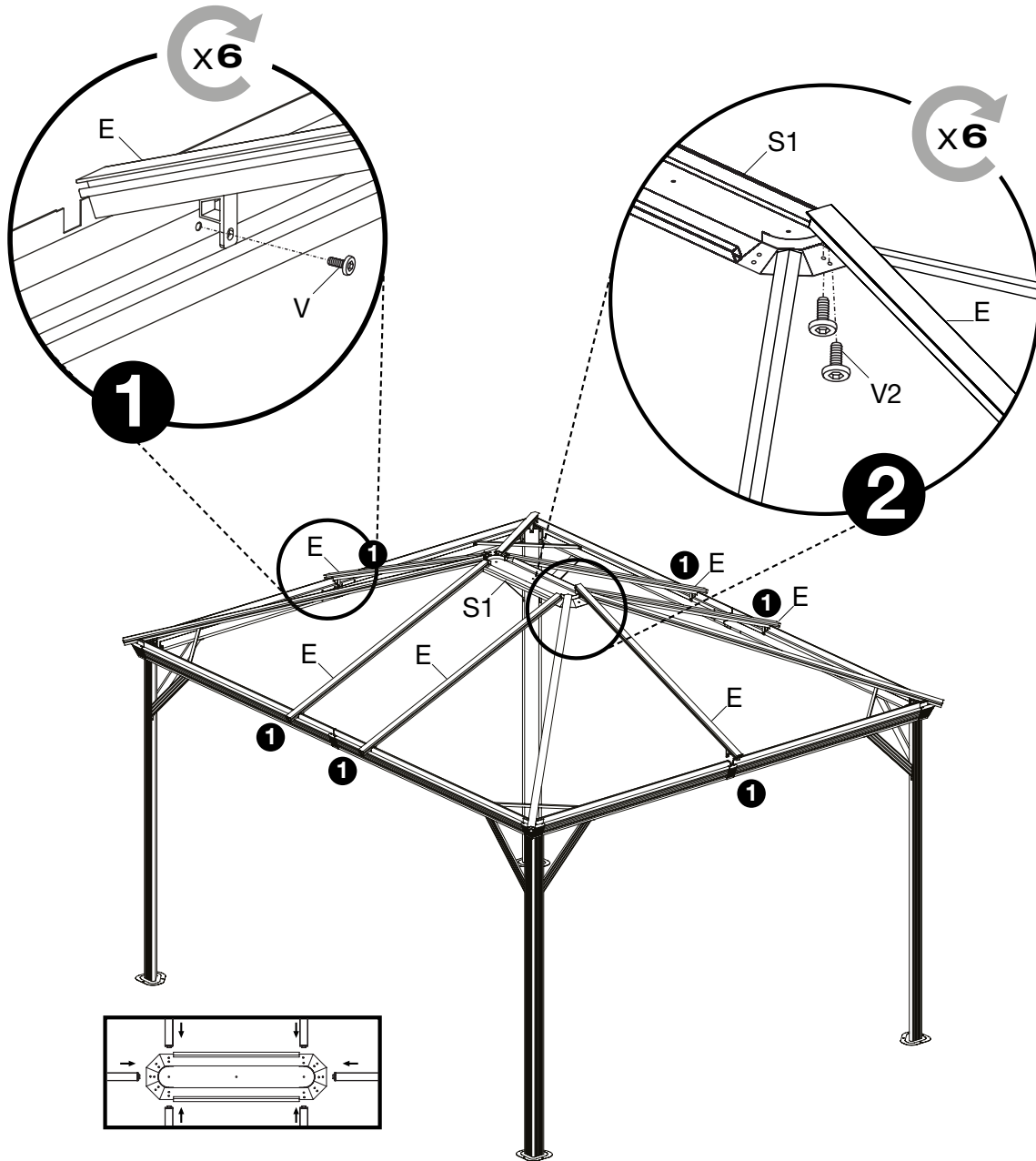

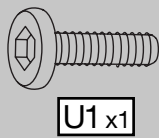
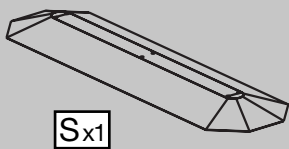
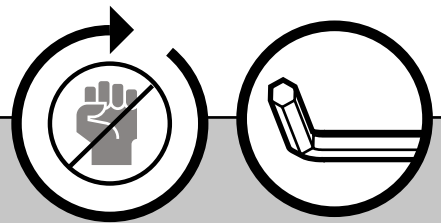
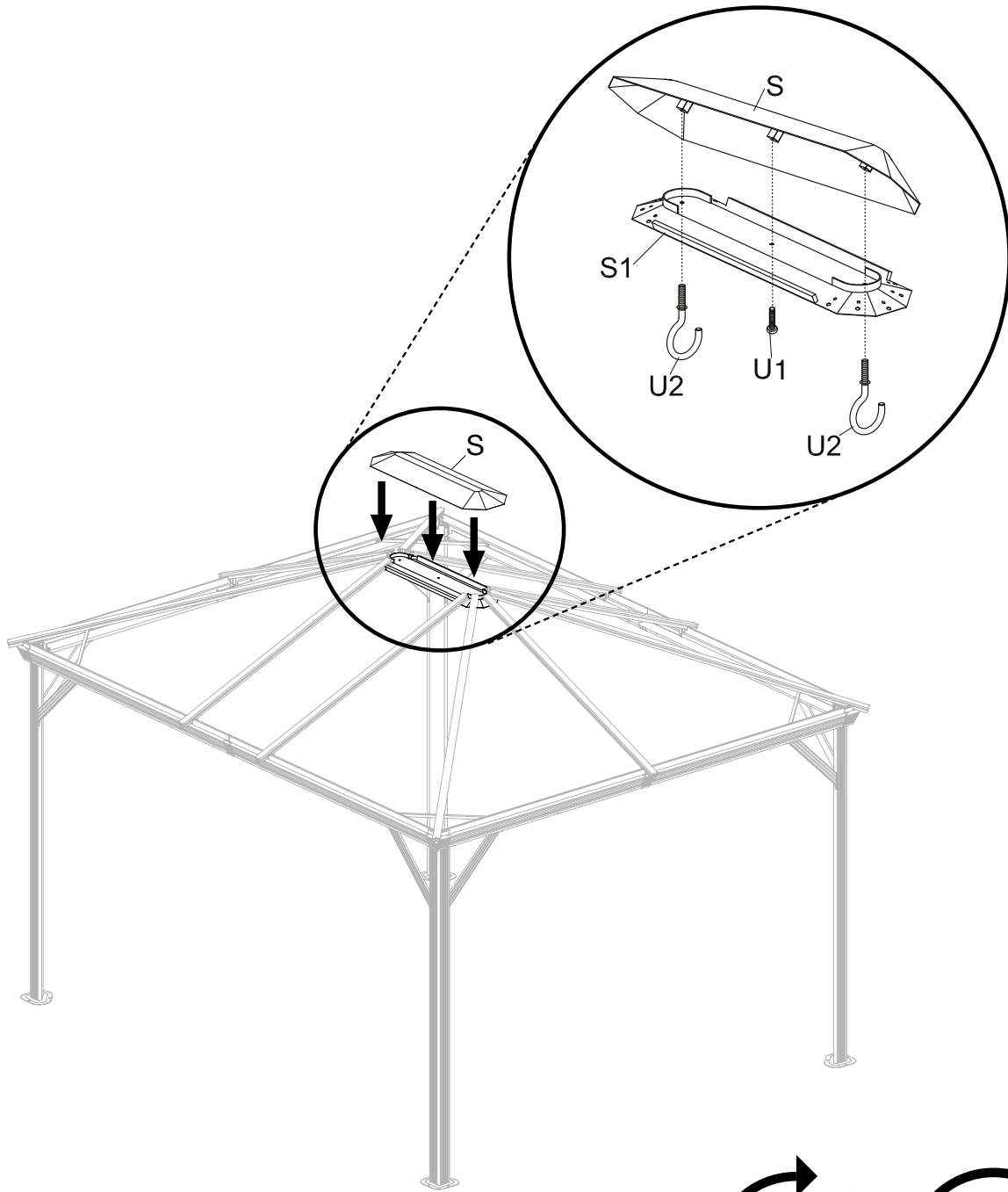



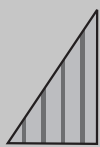
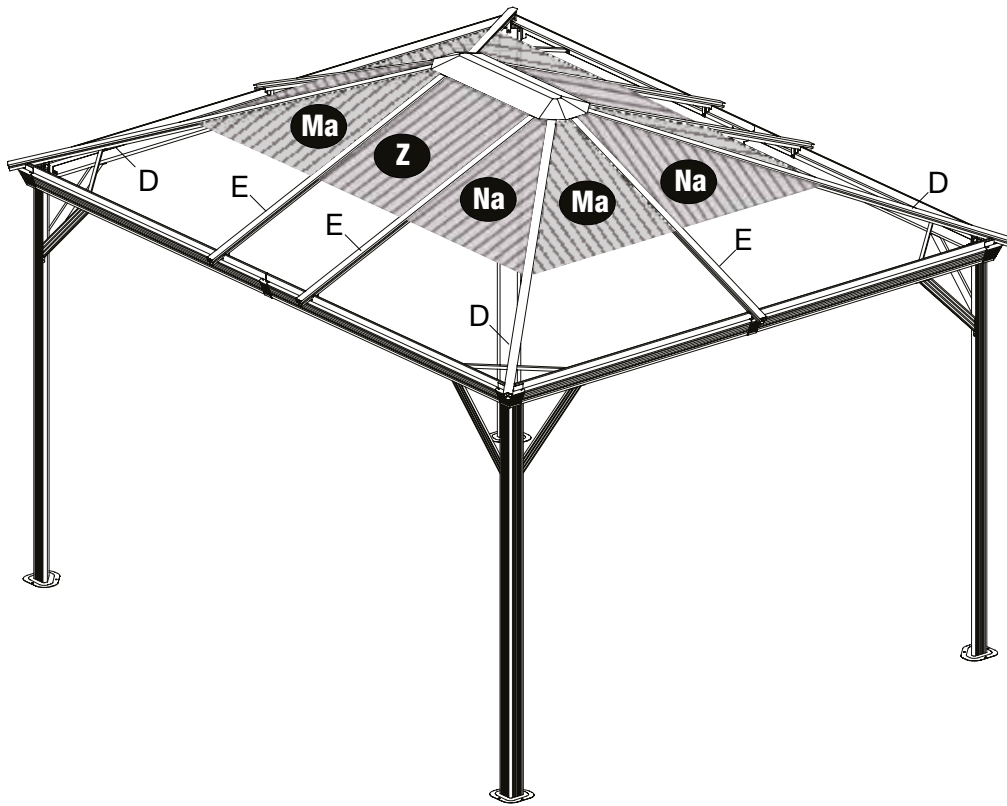
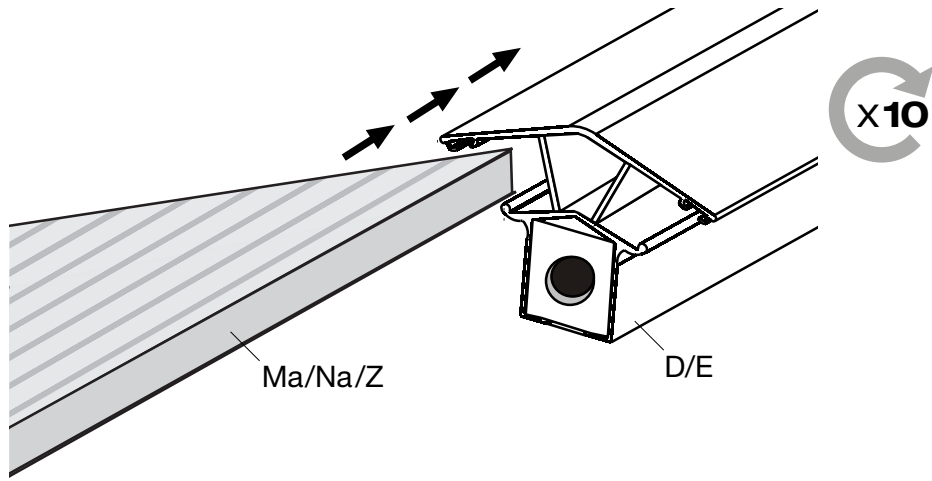

Ma x4



Z x2



Na x4

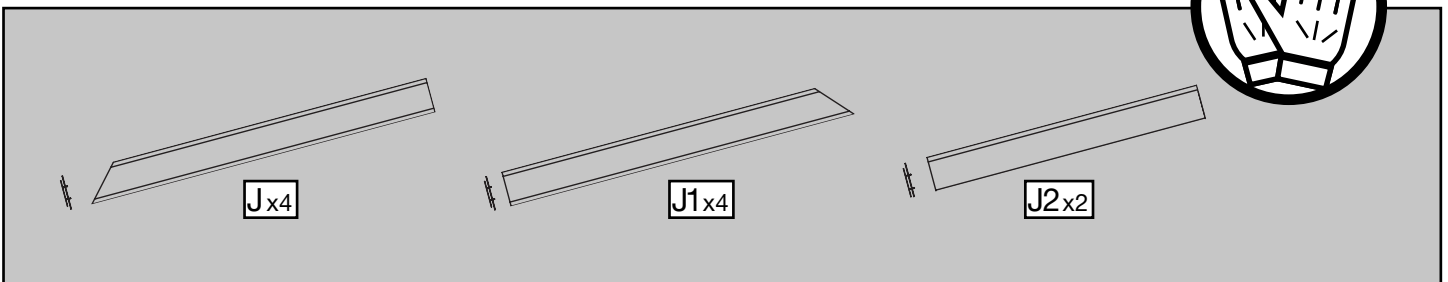
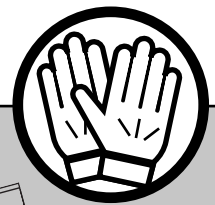
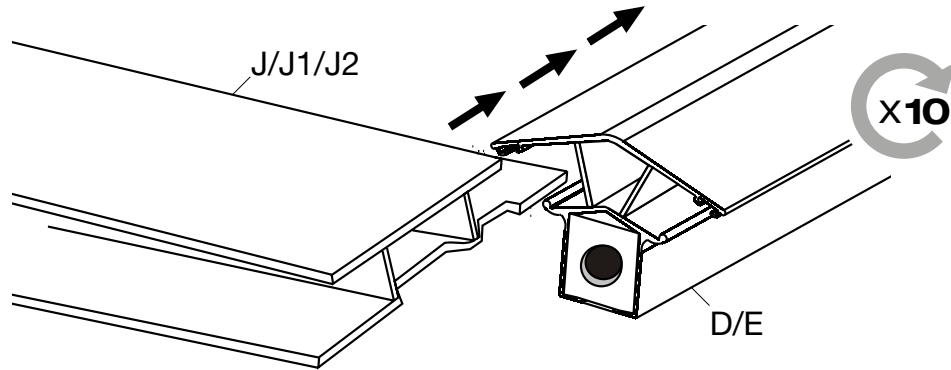

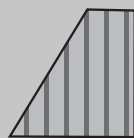
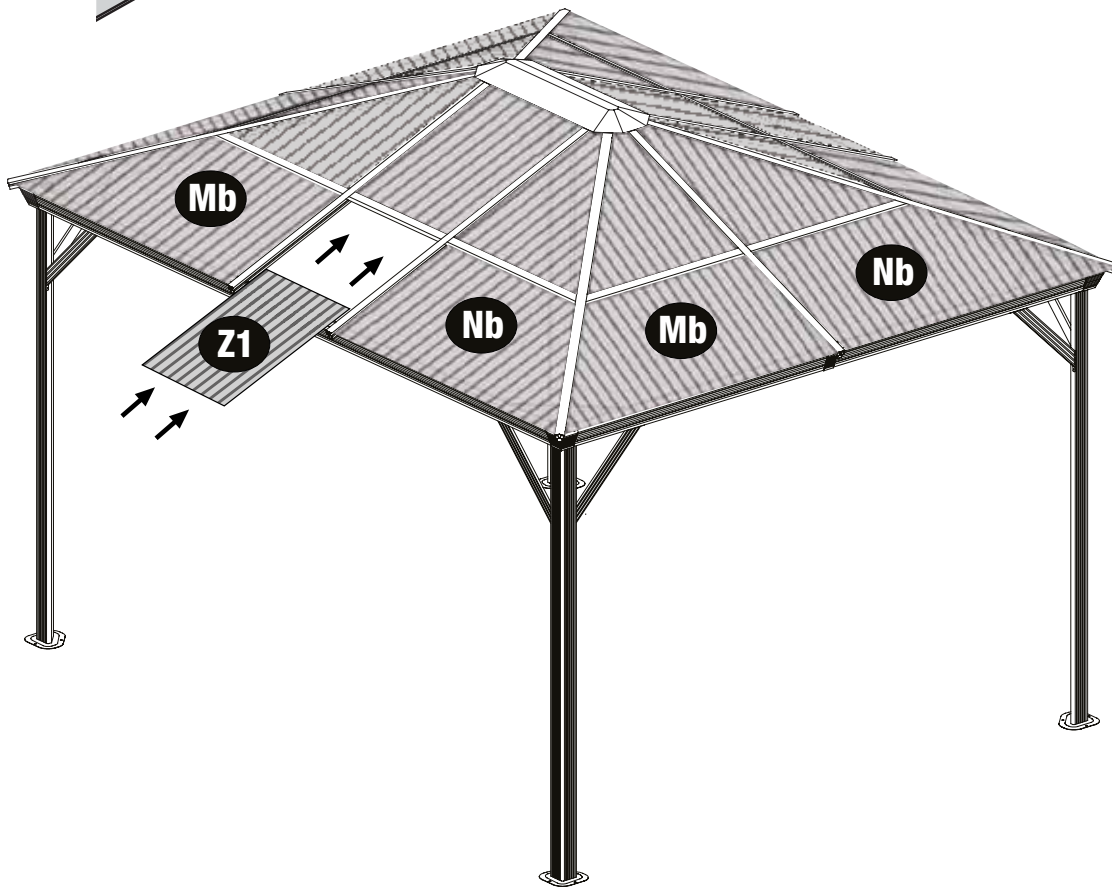
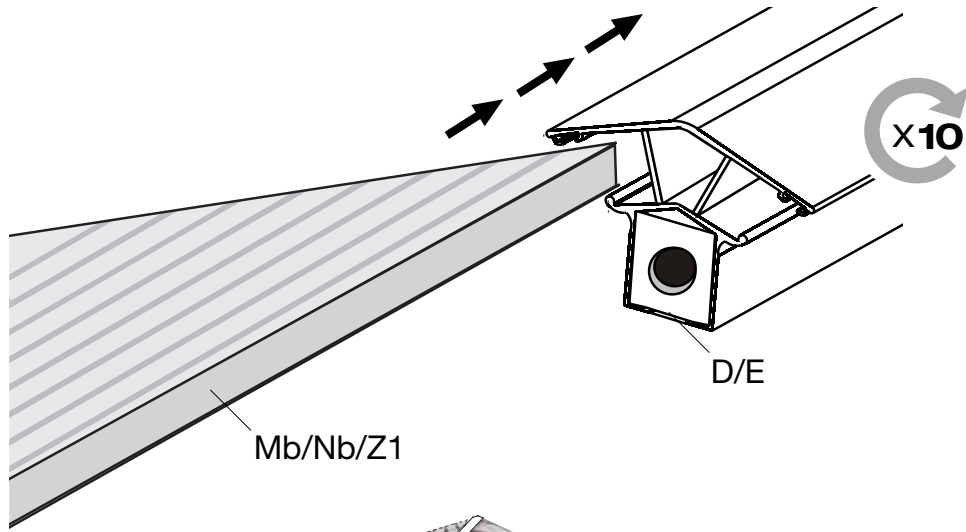

Mb x4

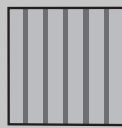

Z1 x2

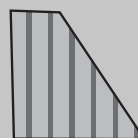

Nb x4

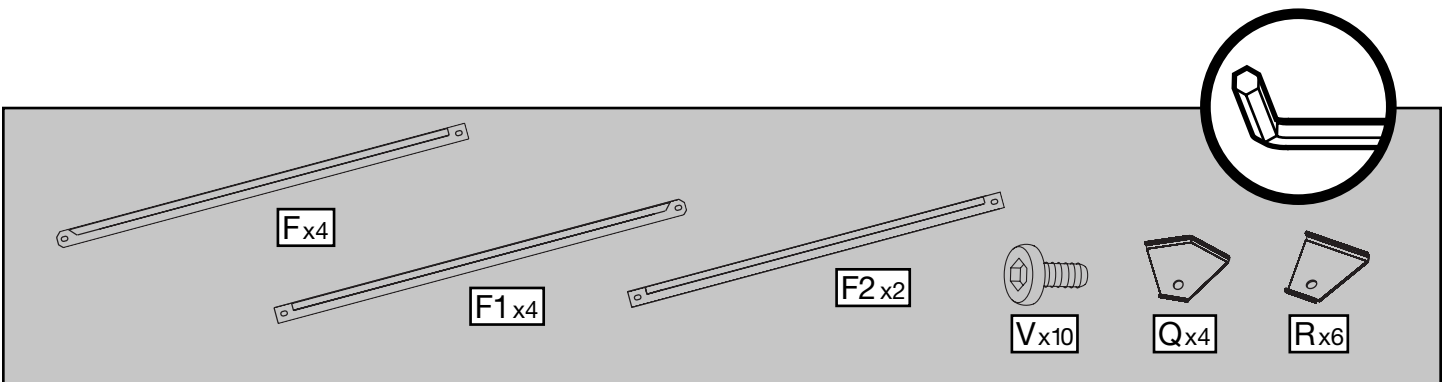
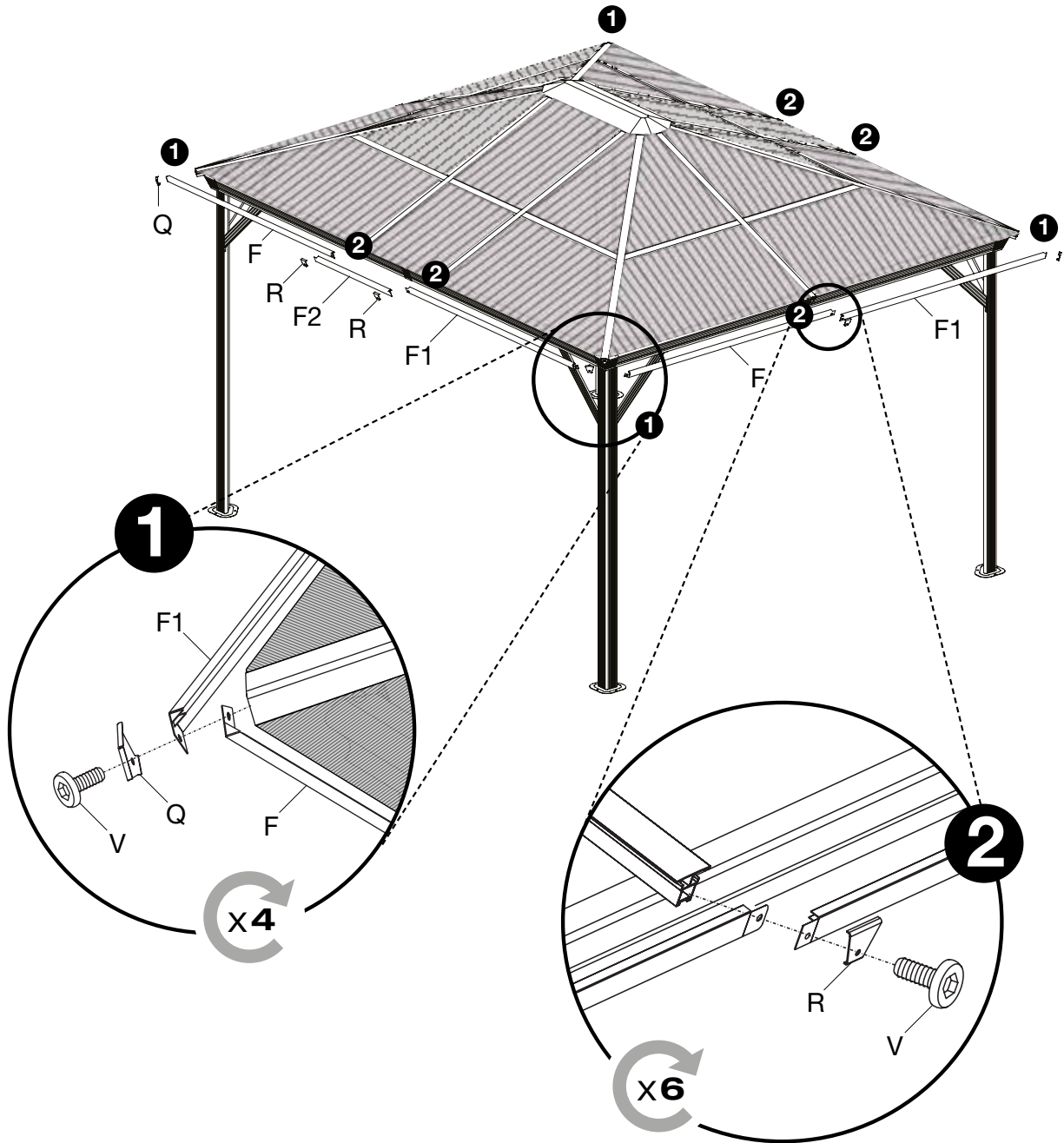

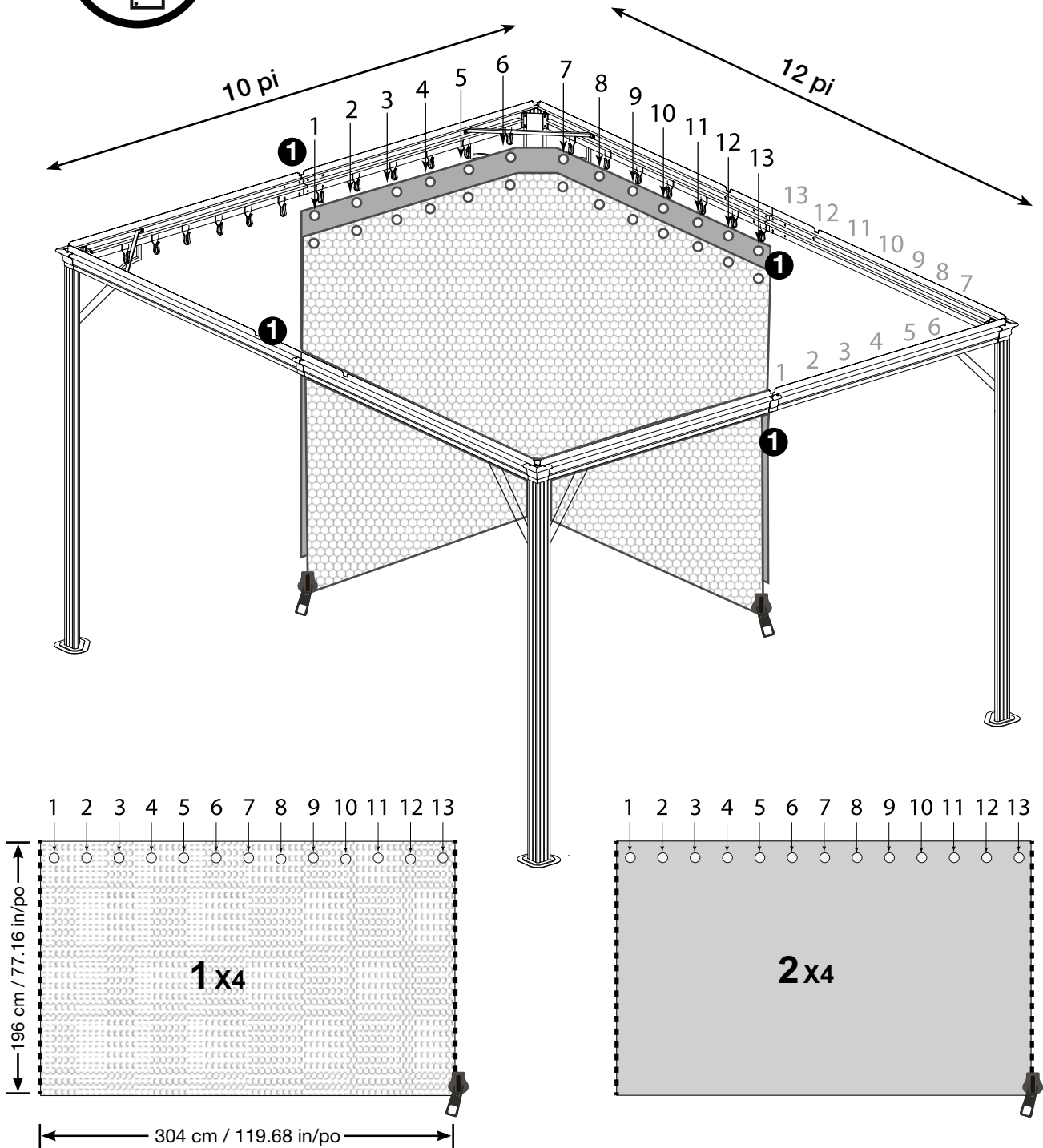





**SOJAG** ■ I  
produits saisonniers • seasonal products