

Item ID	Front Thickness [in] mm	Door Thickness [in] mm
EH2135B-GB	[.75] 19	[.75] 19

This profile  
belongs to  
EH2135B-GB

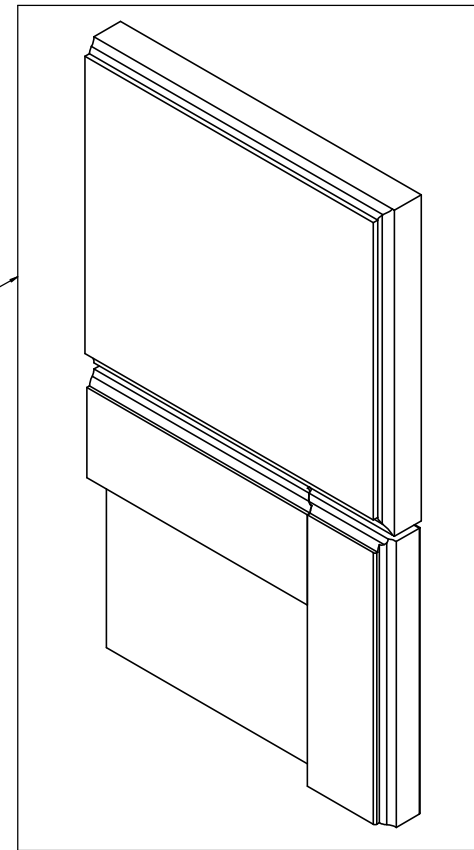
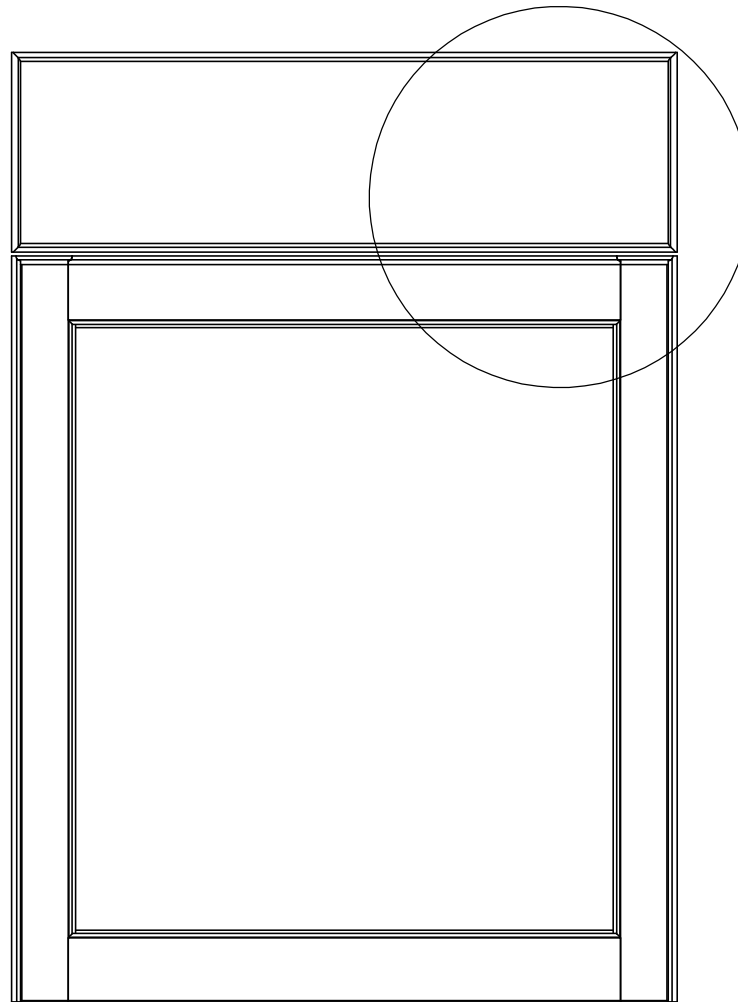

Detailed View

**Profile: Easthaven German Beech**

PROPRIETARY AND CONFIDENTIAL  
THE INFORMATION  
CONTAINED IN THIS DRAWING  
IS THE SOLE PROPERTY OF  
WOODCRAFTERS. ANY  
REPRODUCTION IN PART OR  
AS A WHOLE WITHOUT THE  
WRITTEN PERMISSION OF  
WOODCRAFTERS IS  
PROHIBITED.

UNLESS OTHERWISE  
SPECIFIED  
DIMENSIONS ARE IN  
MM AND [INCHES]  
TOLERANCES ARE  
+.039[1]-.039[1]  
SCALE:1:2



Item ID	Shelf Thickness [in] mm	Shelf Length and Width	Depth "X" [in] mm
BT0935B-BT	N/A	N/A	[24.7] 626.5
BT0935B-WH	N/A		[24.5] 622.5
BT0935B-RC	N/A		[24.7] 626.5
CM0935B-DK	N/A		[24.7] 626.5
EH0935B-GB	N/A		[24.7] 626.5

Description					
Kitchens-Base Cabinet 9.0W x 34.5H					
REV	ECO#	Description	REV'D BY DATE	CHK'D BY DATE	APRV'D BY DATE

1/2in Full Back  
197x875.5mm

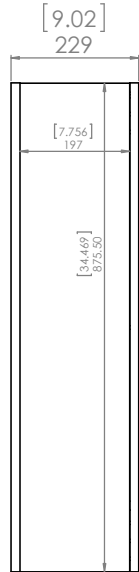

Back View

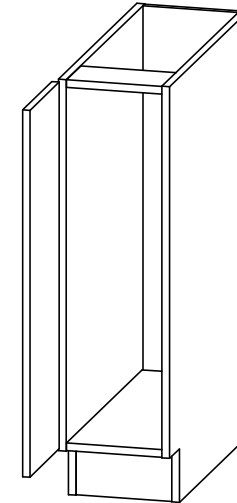
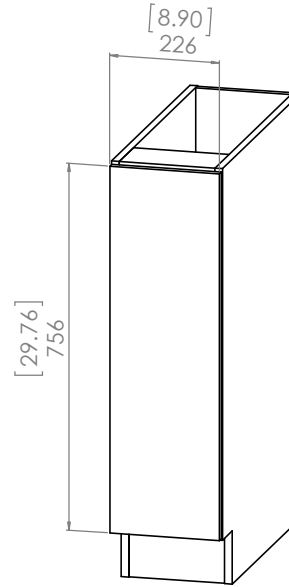

Isometric View

Front View  
(front door removed)

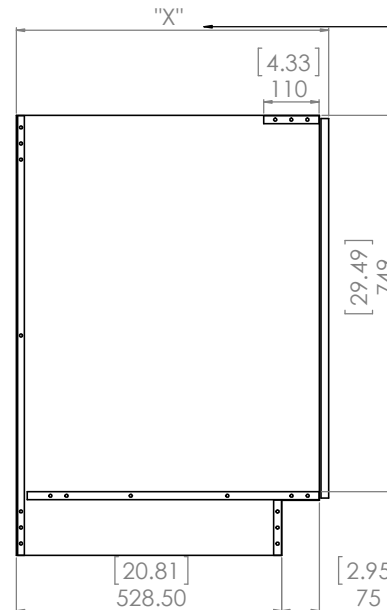
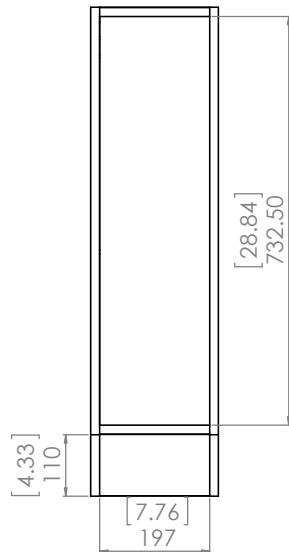

Depth "X" depends on door profile

Side View  
(left panel removed)

NAME	SIGNATURE	DATE			
DRAWN	Mark Flores	10/30/17			MATERIAL:
CHK'D					
APPV'D					WEIGHT:
MFG			PROPRIETARY AND CONFIDENTIAL UNLESS OTHERWISE SPECIFIED THE INFORMATION CONTAINED IN THIS DRAWING IS THE SOLE PROPERTY OF WOODCRAFTERS. ANY REPRODUCTION IN PART OR AS A WHOLE WITHOUT THE WRITTEN PERMISSION OF WOODCRAFTERS IS PROHIBITED.		
			DIMENSIONS ARE IN mm AND (INCHES) TOLERANCES ARE +/- .10(0.39) SCALE:1:5	Base_Cabinet_9in A1	
			SCALE:1:5	SHEET 1 OF 1	