



INSTALLATION GUIDE

3', 4', & 6' HIGH FENCE

1.866.648.9336

www.simtekfence.com



INSTALLATION GUIDE

These instructions are designed to assist both professional installers and do-it-yourselfers of SimTek™ decorative rock-walls. These instructions are detailed to insure an excellent finished wall.

A quality finished wall is a result of a quality installation. The layout must be consistent with ground contours; posts must be appropriately spaced and properly anchored. Follow SimTek™ installation instructions carefully and your wall will be both structurally correct and a beautiful addition to your project or property.

Before any installation, check all local regulations regarding fencing, location of all buried utility lines, and correct property lines. Be certain that you are in compliance with all local codes, permits, county and state laws. Ensure that you have all the components needed to complete your fence configuration.

TOOLS NEEDED

Tape Measure

Level

Auger or Post Hole Digger

Shovel

Power Drill

Circular Saw

Concrete

Spray Paint

Mallet or Hammer

Fence String



Step 1: Lay Out Fence Line

1. Locate your property line and stretch a string between stakes from the beginning to the end of the fence to ensure posts will be set on a straight line.
2. Beginning at the corner or end post, mark the location of the post. Dig a hole for each post.

Center to Center Post Dimensions

	Line	Corner	End	Gate
Line	71 ½"	72 ½"	71 ½"	72 ½"
Corner		73 ½"	72 ½"	73 ½"

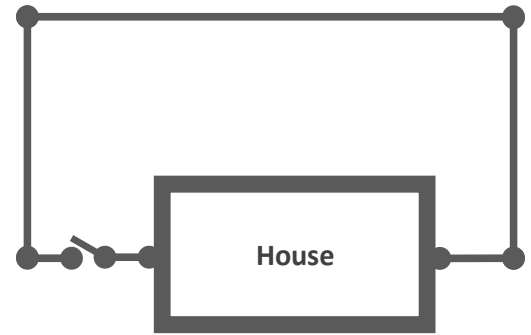

Scan QR Code
to watch our
installation video



Step 2: Digging Holes

1. If a laser is available, it will be an excellent tool to assist in determining grade and slope.
2. For a level ground installation, begin at a corner or an end post. This will give you a good starting point. If there is a slope, it is easier to begin at the top and work your way down hill.
3. Dig all post holes 10"- 12" diameter by 30"- 36" deep for the six foot high wall and 24" deep for the 3ft and 4ft high walls. Make sure to check local building codes to ensure required depths and diameters are met.
4. Holes must be 71.5" apart, center to center for the six foot wall and 96" for the eight foot wall. It is essential that the panel stiffener touches post to post. The panel stiffener is wider than the panel to accommodate panel thermal expansion. **DO NOT CUT THE STIFFENER UNLESS THE PANEL IS BEING CUT SHORTER.**
5. Walls will rarely measure out to an exact number of full panels; therefore it will likely require cutting one or more panels to complete a wall. Depending on personal preference, you may wish to narrow the width of the last 2 to 3 panels or cut the first and last panels evenly so that there is not one very narrow panel. Panels can be cut with any circular saw, although the steel stiffeners will require a metal cutting blade.



Need Help? call us at 1.866.648.9336

Tip

- Dig a hole 10"-to-12" in diameter
- Holes should be 24" deep for 3ft and 4ft panels and 36" deep for 6ft panel. However, please consult your local building codes
- Use one and a half or two 80 lbs ready mix bags of concrete

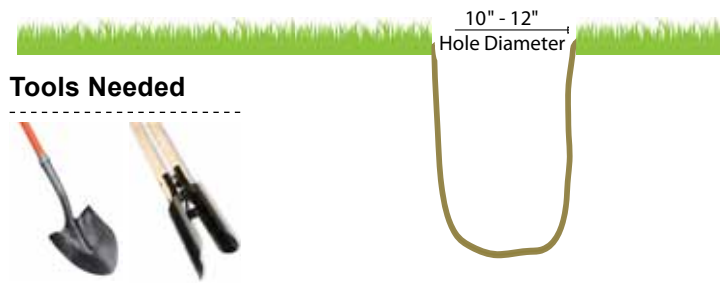

Tools Needed



Step 3: Installing Fence Brackets

If posts are to be installed in level ground attaching brackets in advance of post installation is easiest when using a measuring template for faster repetitive bracket installation. It is easier to change a bracket in the field if necessary than to install brackets once posts are installed in the ground.

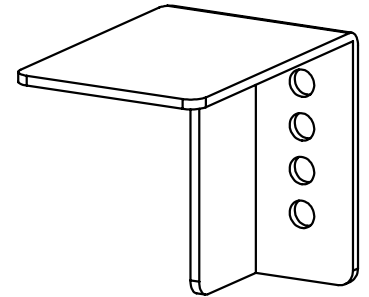

Installed brackets provide a leveling point on each post.

DISTANCE FROM TOP OF POST TO SUPPORT BRACKET SURFACE

Panel Size	3'	4'	6'	8'
Bracket location	37.5"	49.5"	73.5"	99"

Tip

Note: Brackets come packaged at the tip of the post during shipping. They must be removed and reattached in the channel of the post at the desired height during installation.

Step 4: Post Spacing & Concrete Footings

3' High Panels

- For a 3' installation, the bottom of the post should be cut leaving, a 62" post (38" above ground and 24" below ground)
- Cut the bottom of the post. DO NOT cut the top of the post

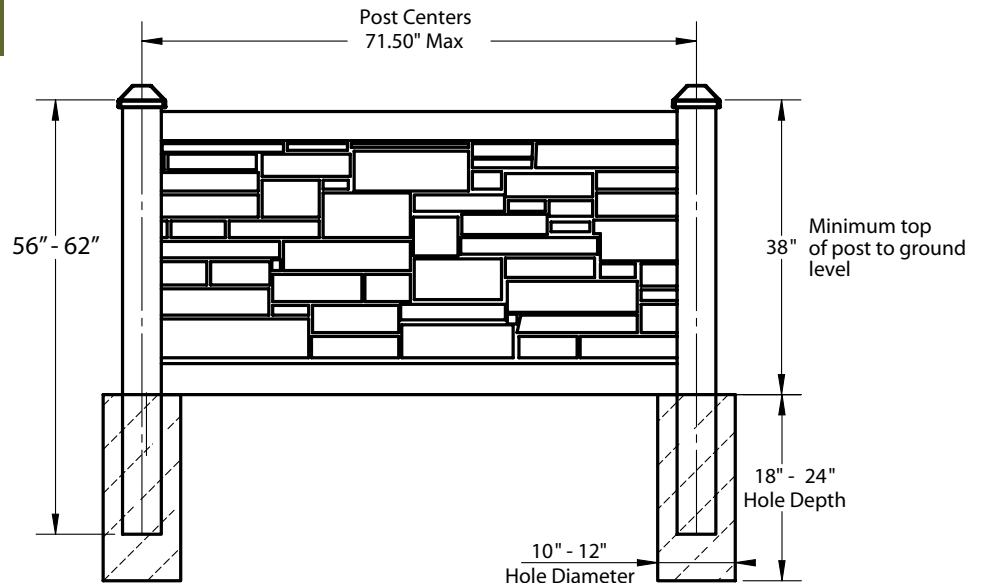

4' High Panels

- For a 4' installation, the bottom of the post should be cut leaving a 74" post (50" above ground and 24" below ground)

- - Cut the bottom of the post. DO NOT cut the top of the post

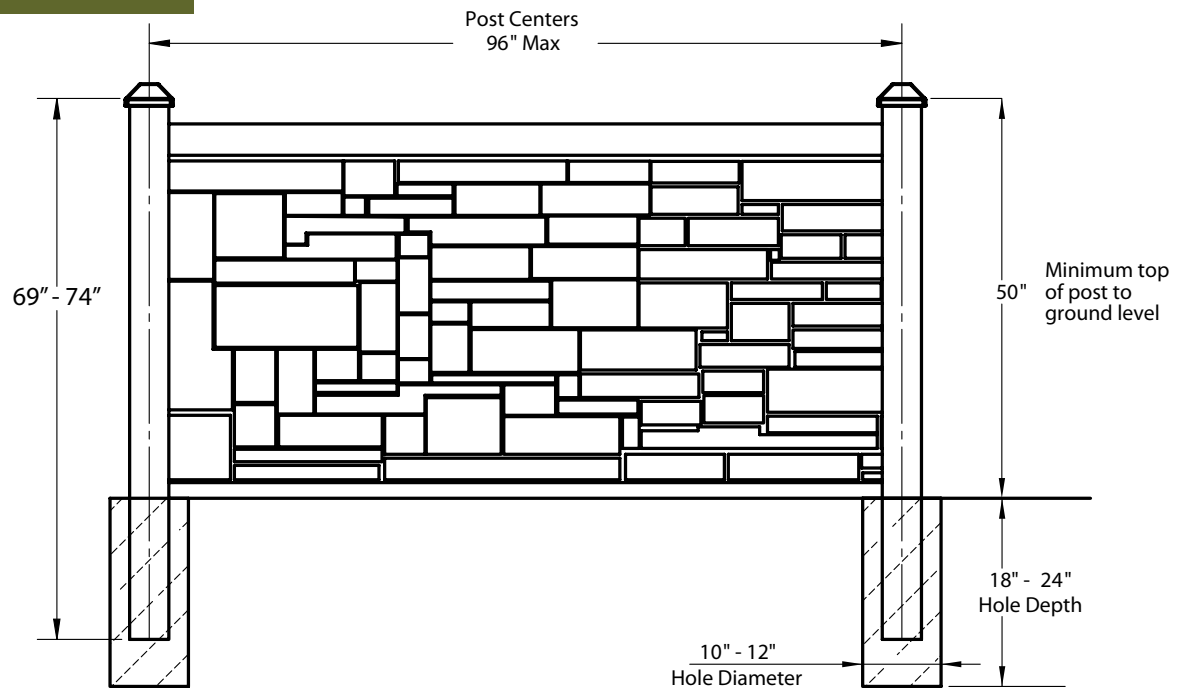

6' High Panels

- For a 6' installation, use our 102" posts which is designed to be 28"-to-30" in the ground and 72"-to-74" above ground.

- Cut the bottom of the post. DO NOT cut the top of the post

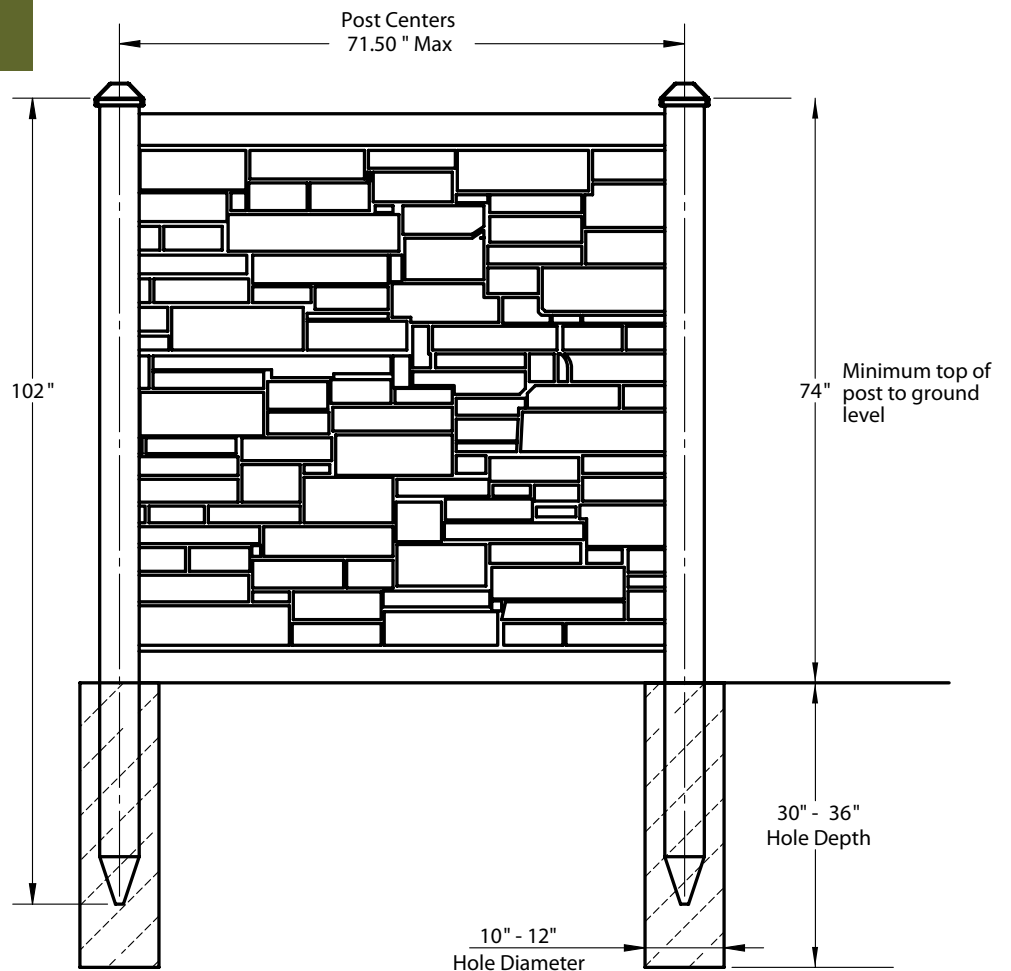

Step 5: Setting Posts

1. Set a post in the hole with concrete. Using a mallet or hammer, tap the post into the concrete until the top of the post meets the desired height.
2. Fill the remainder of the hole with concrete. Using a level, check two adjacent sides of the post. Two-way levels are useful. Adjust the post until it is both vertical and at the correct height.
3. If using a dry mix method, first place the post in the hole in the approximate position at the bottom of the hole. Pour the dry mix in the hole, positioning the post as soon as it is feasible.
4. Using the steel stiffener out of the panel, which is exactly 70.25" for the 6ft wall and 95" for the 4ft wall, as a spacer, set the next post the same as the first.
5. Do not move the post which is now in position. Leave the panel stiffener spacer in place for one hour minimum, as concrete begins to cure, to keep the posts from moving. Set 3 to 4 posts with panel stiffeners as spacers, then advance them one at a time, by moving the first spacer placed. Allow the concrete to cure for a minimum of 24 to 48 hours.
6. For a complete step-by-step installation video, visit our website at: <http://www.simtekfence.com/product-information> or for personalized assistance call our customer service line at 1-866-648-9336.

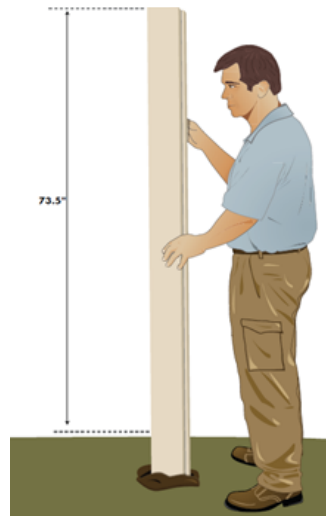

Make sure post is straight, plumb, and evenly spaced

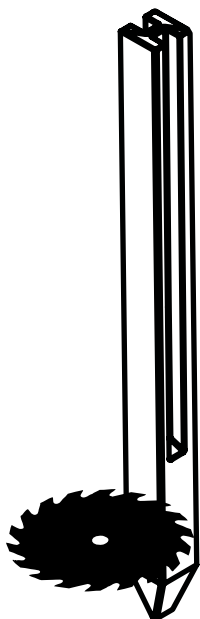
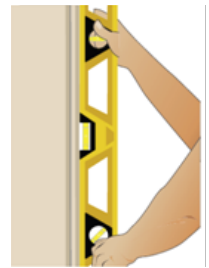

Note: All SimTek posts are reinforced with galvanized steel. If posts need to be cut, we suggest cutting them at the tip. DO NOT cut the top of the post.

Cutting the top of the post will VOID the warranty

For more info
Scan QR Code
and visit our site



Step 6: Installing Fence Panels

1. Panel support brackets must be attached to all posts.
2. Be certain steel stiffeners are inserted in the top and bottom rail of each panel; they come installed from the factory, but may have been removed to use as post spacers while installing posts.
3. Panels are universal, with no front or back, and no top or bottom edge. This allows you to create a mixed design for a better aesthetic effect.
4. Lift the panel bottom edge to approximately 4' off the ground. Have one person flex the next post outward until the groove will receive the panel. Once the section is in the channel, ease the panel down onto the support brackets.
5. Install caps over the posts.
6. Caps are pressure fitted making securing them typically unnecessary; however, a 3" stainless steel deck screw can be driven through the top of the cap into the middle of the post if desired.



Step 7: Securing Panels

1. Panels must be attached to all six foot gate posts, end post and corner posts because they could conceivably become disengaged from the post because of the shallower groove.
2. To prevent unauthorized panel removal, you can drive one fastener per panel through the panel edge into the post.
3. Caution. Never attach both sides of the panel to posts. Polyethylene has a degree of thermal expansion and contraction.

#14 Hex Washer Head, 3"
Self Tapping Screw



Fasteners should attach panels to end post and corner post inside panel grooves

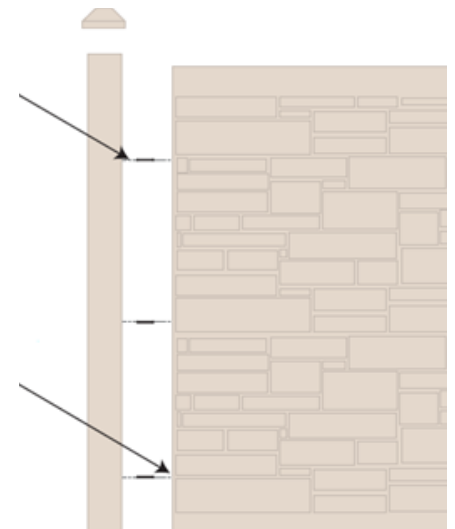

Tip

Note: Never attach both sides of any panel to posts.

Step 8: Cutting Panels

Where a narrower panel is required to finish a wall, panels can be cut to any desired length.

1. Remove steel stiffeners from panels. Determine the exact width between post channels. Mark and cut stiffeners to that width with a metal cutting blade.
2. Mark and cut the panel to the stiffener width, minus $\frac{1}{2}$ " to allow for thermal expansion and contraction of the panel. Make certain panels are cut accurately with edges parallel.
3. If a cut panel is used with an end or corner post, use the factory edge for attachment to the post.
4. For steeper slopes, panels can be cut so the step or drop in each section is 12" or less.

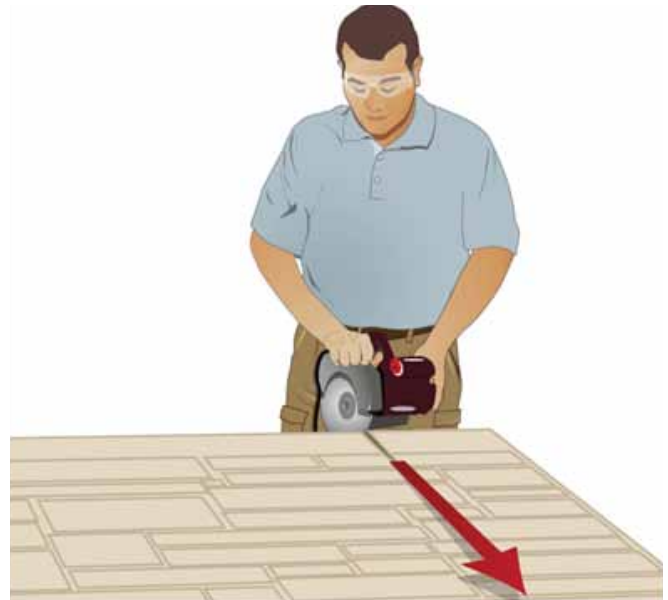

Installing on a Retaining Wall

SimTek can be installed on top of an 8" minimum width poured concrete wall or on flat concrete using SimTek's Concrete Mounting Brackets. Concrete surface mounts are manufactured with a heavy steel plate with vertical members. It attaches to the concrete with anchors and bolts to the post. Specific concrete shoes are available for end posts, line posts, corner posts and gate posts

1. Cut the post to the desired height. Post may need to be cut longer to accommodate changes in elevation. Always cut off the bottom of the post, retaining the factory finished post top.
2. Panel support brackets are unnecessary when using concrete shoes. The Panels will sit directly on the wall or driveway surface.
3. Start at the corner or an end post position. Locate the concrete shoe an equal distance from the edges of the concrete.
4. Mark the position of the plate. Drill all four holes through the pre-drilled holes in the steel plate.
5. Next install all the concrete anchor bolts in the base plate bolt holes provided with a minimum tension and shear strength of at least 4,000 lbs. Position the bolts to fasten the mounting place of the shoe.
6. Place the shoe over the bolt and attach the shoes to the concrete with specified fasteners

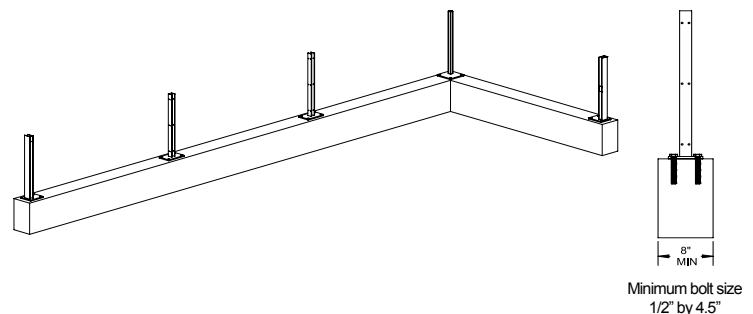

7. If the concrete is not level, washers may be placed over anchor bolts and before shoes are bolted down to serve as leveling devices.
8. Position the skirt covers over the shoes, covering the metal plates. Skirts must be inserted prior to posts being attached.
9. Attach the mounting brackets to the posts with fasteners in pre-drilled holes. Each side of the strap gets three staggered screws installed from opposite sides of the post for line posts and three each for ends and corners.
10. With the first shoe anchored, and the post attached, determine and mark the next shoe position using a panel stiffener as a spacer. It will measure 71.5" (for 3' high and 6' high) from the center of the next post and 1" shorter for a line to a corner post. For 4' high and 8' high sections, it will measure 96" center to center.
11. Cut 7/8" of the bottom panel stiffer to accommodate the shoe strap and its screws. It is also recommended to remove 1/2" off the lower two feet on both sides of the panel edge to accommodate the shoe straps as well.
12. Mark and drill the holes for the next shoe.
13. Once all the shoes and posts are securely anchored to the wall and skirts are in place, insert the panels. Be certain that steel stiffeners are in both top and bottom rails of each panel.
14. Finally, place the caps on the post for a finished look.

Concrete Surface Mounting Brackets

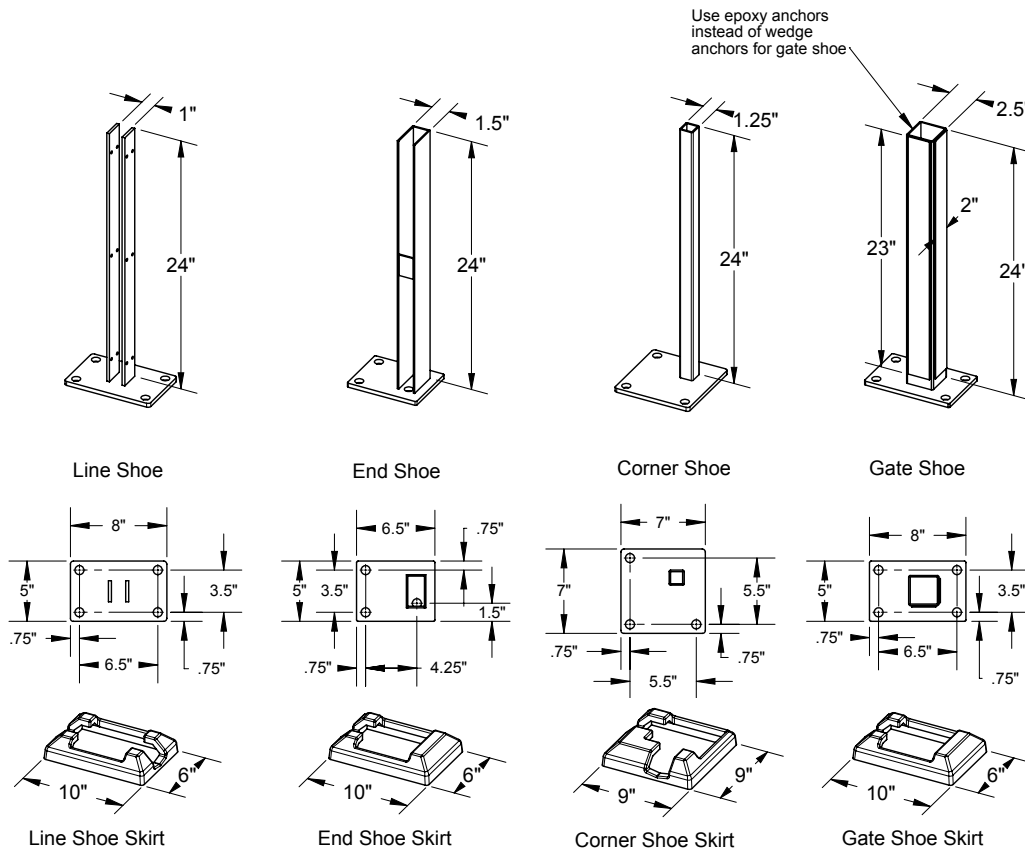

Installing on Sloping Terrain



Caution: SimTek Fence is not engineered for use as a retaining wall.

Installation on sloping terrain is similar to that on flat terrain. Professionals typically use a laser to shoot and obtain a grade.

1. Set the first post on the uphill side. Post placement is important! Posts are typically placed at the point where the slope changes whether in a peak or a valley.
2. The panel support brackets should be pre-attached at $37\frac{1}{2}$ " for 3ft, $49\frac{1}{2}$ " for 4ft, $73\frac{1}{2}$ " for 6ft, and can receive the down hill side of the panel at that height. Once the slope and the drop per panel have been determined, the bracket on the uphill side should be adjusted to the proper height. Panels will always be set level even on a slope.
3. Set the second post and make any adjustments to bracket position.
4. Use steel stiffeners for spacing to set the distance for each succeeding post.
5. Use a level on the stiffener to insure panels will be level when installed.
6. For more information see illustration A and B
7. Please visit our website for a full installation video <http://www.simtekfence.com/install/>

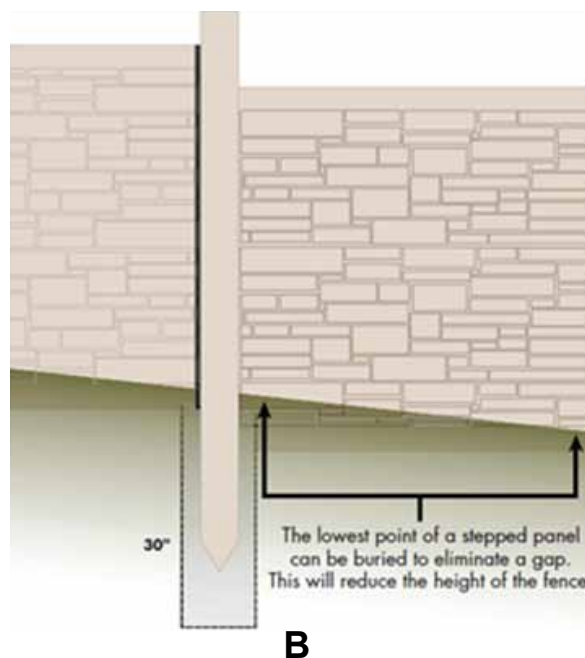
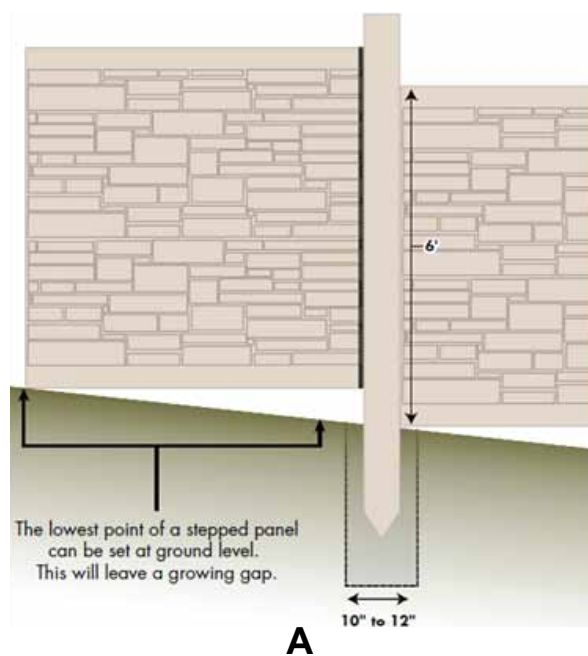

FYI

A 6' wide panel can be stepped as much as 12" per panel. For steeper elevations you can use our 142" long post. For more details and instructions call your sales representative

SimTek Gate Installation Guide

Gate Components and Tools Needed

- Gate Post
- SimTek™ Fence Gate
- End Post
- SimTek™ Hinges
- Latch
- Striker Rod (optional)
- 2 ½" Self-tapping Screws
- Button Head Screws
- Level and Power Drill
- Concrete

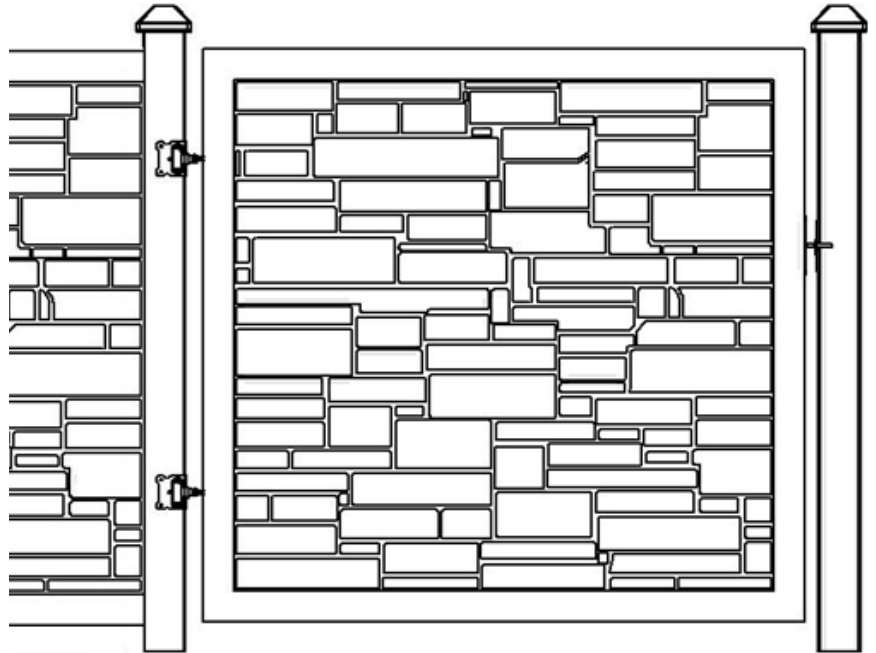

Step #1: Set the Gate Post

Gate posts have extra steel reinforcing for strength and are different than all other posts. Before setting the post in the ground, make sure that a gate post (not an end post is used)

1. Dig a hole 10" to 12" in diameter by 30" to 36" deep in the ground.
2. The flat surface (without a channel) must be in position to receive the gate and gate hardware.
3. Post spacing is critical. The ideal spacing is to have a 1" gap between the latch post and the striker bar side of the gate and 1 ½" for the hinge side. The extra gap on the hinge side is to allow for thermal expansion and contraction.
4. Set the post utilizing the same method as for other posts and fill the hole with concrete. Allow the concrete to cure for 48 to 72 hours.

Gate Post

(Hinges are attached to this post)

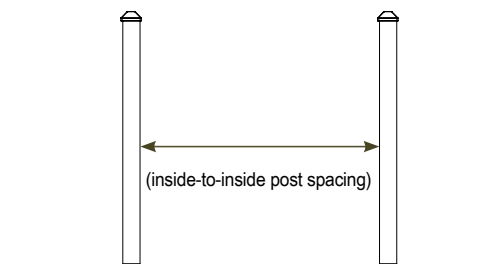

End Post

(The latch is attached to this post)

Step #2: Gate Openings

All gates require about a 1 ½" gap between the gate and the gate post, and about a 1" gap between the gate and the end post or between the two gates when using double gates.

For a single gates, use one gate post and one end post. For double gates, use two gate posts.

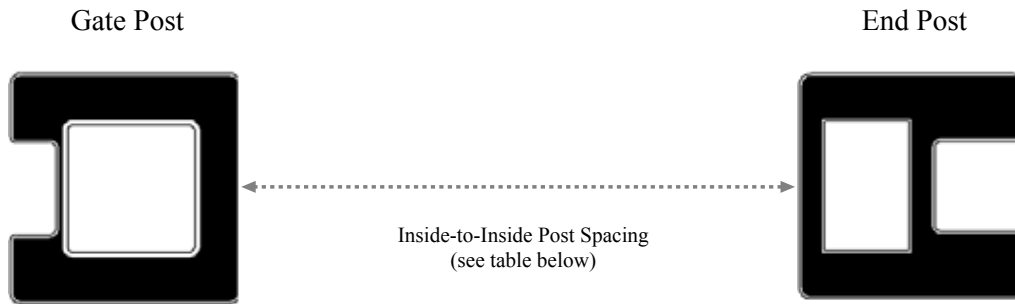

Gate Width	Single Opening	Double Drive w/3' Gate	Double Drive w/4' Gate	Double Drive w/5' Gate	Double Drive w/6' Gate
3ft Wide Gate	38.5"	76.0"	88.0"	100.0"	112.0"
4ft Wide Gate	50.5"	88.0"	100.0"	112.0"	124.0"
5ft Wide Gate	62.5"	100.0"	112.0"	124.0"	136.0"
6ft Wide Gate	73.5"	112.0"	124.0"	136.0"	147.0"

SimTek Gates

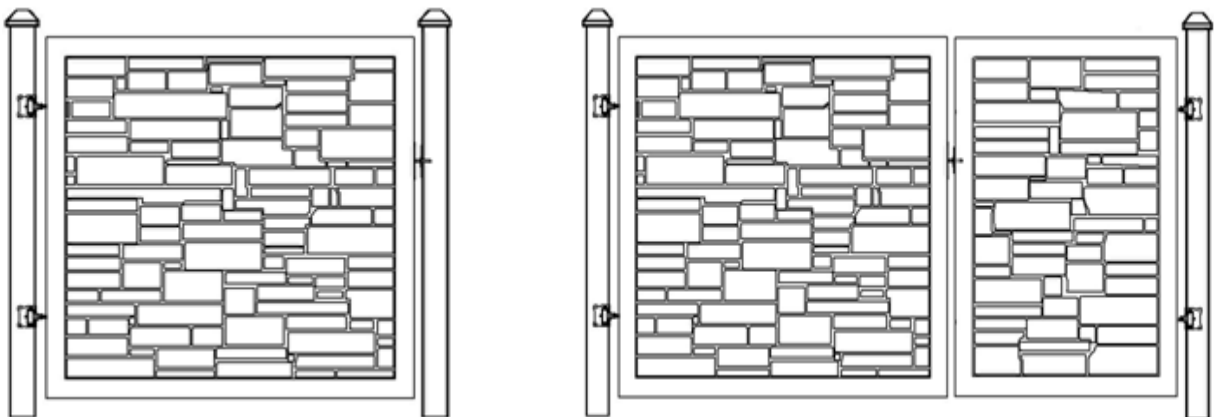

Step #3: Gate Hardware Installation

- A. Attach the striker rod to the gate by using the provided button head screws.
- B. Thread the 1/2" hinge rod into the upper and lower inserts in the gate metal frame leaving about 1 1/2" from the edge of the gate to the bracket (this can be re-adjusted later)
- C. Next hold the gate and its hinges against the gate post at the proper position and height. Drill the provided 2 1/2" self-tapping screws into the gate post.

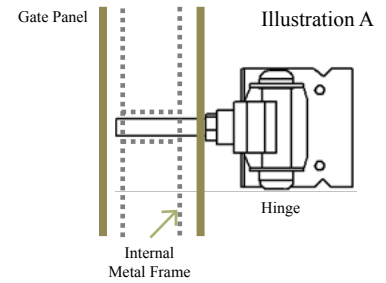

DO NOT over tighten the screws because it can crush the internal foam, making an indentation in the post.

- D. Level the gate. The standard height should be level with the top of the fence panel. Gates are designed with a 4" gap at the bottom to facilitate an unobstructed swing. If you desire a gap smaller than 4", you may lower the gate relative to the fence panels.
- E. Finally, align the latch with the striker rod and attach the latch to the end post by using the supplied 2 1/2" self-tapping screws.

SimTek Hinge

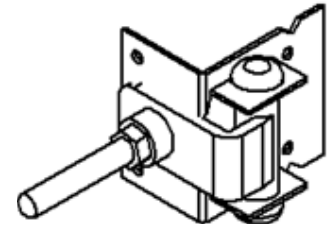

2 1/2" Zinc Plated Self Tapping Screw

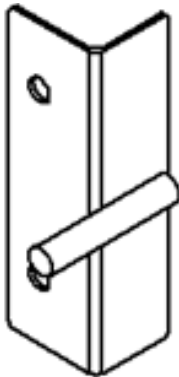

Striker Rod



Button Head Screw

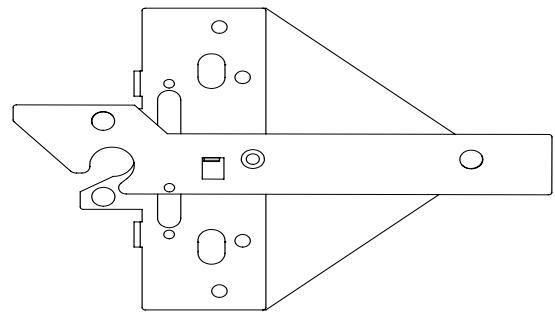

Latch



2 1/2" Zinc Plated Self Tapping Screw



WARRANTY INFORMATION

SimTek™ Fence warrants the product line to be free from manufacturing defects in materials and workmanship for 25-years from the date of purchase, or for as long as the original end-user purchaser of the product owns and occupies the real estate on which the product was first installed. The manufacturer's warranty does not apply to installation.

What We Cover. When proper installation procedures are followed and under normal and proper use, SimTek™ Fence will not crack, warp, peel, rot, blister, fade or drastically change colors. If such defects or degradation is discovered, SimTek™ at its sole discretion will repair, replace the product, or provide the customer a credit for the value of the product subject to the warranty within a reasonable time following the receipt by SimTek™ Fence of notice of such a defect.

Limitations and Exclusions. This warranty does not cover damages as a result of abuse, misuse, vandalism, unauthorized repairs or modifications, defacement, neglect, accidents, improper installations, or improper use, acts of god, improper ground settlement, failure of any structure or soil in which the fence was installed, exposure to extremely harmful chemicals, fire, etc. SimTek™ will not be responsible for labor or other expenses not directly incurred by SimTek™ in effecting any claims under this warranty.

SimTek™ reserves the right to modify, enhance, discontinue its products, including colors and will not be responsible in the event replacement products vary in granite colors compared to the original product as a result of reasonable weathering and/or product engineering.

Registration. In order to receive full benefits on this warranty, you must register your warranty within 90 days of installation by completely and accurately filling out our online warranty registration at our website: www.simtekfence.com/registration/