

Before using your air conditioner, please read
this manual carefully and keep it for future reference.

INVERTER SPLIT-TYPE ROOM AIR CONDITIONER

USER'S MANUAL

The design and specifications are subject to change without prior notice for
product improvement. Consult with the sales agency or manufacturer for details.

CS002U-BP9A1(UL)
202000192382
20120828

Read This Manual

Inside you will find many helpful hints on how to use and maintain your air conditioner properly. Just a little preventative care on your part can save you a great deal of time and money over the life of your air conditioner. You'll find many answers to common problems in the chart of troubleshooting tips. If you review the chart of Troubleshooting Tips first, you may not need to call for service.

CONTENTS

SOCIABLE REMARK	
Sociable remark.....	2
SAFETY PRECAUTIONS	
Warning	3
Caution	4
OPERATING INSTRUCTIONS	
Parts names	5
Special functions	6
Operating temperature.....	7
Manual operation	7
Airflow direction control	8
How the air conditioner works	9
CARE AND MAINTENANCE	
Care and maintenance	10
OPERATION TIPS	
Operation tips	12
TROUBLESHOOTING TIPS	
Troubleshooting tips	14

! CAUTION

- Contact an authorised service technician for repair or maintenance of this unit.
- Contact the authinstaller for installation of this unit.
- This appliance is not intended for use by persons (including children) with reduced physical, sensory or mental capabilities, or lack of experience and knowledge, unless they have been given supervision or instruction concerning use of the appliance by a person responsible for their safety.
- Young children should be supervised to ensure that they do not play with the air conditioner.
- If the power cord is to be replaced, replacement work shall be performed by authorised personnel only.
- Installation work must be performed in accordance with the national wiring standards by authorised personnel only.

SOCIABLE REMARK

When using this air conditioner in the European countries, the following informations must be followed:

DISPOSAL: Do not dispose this product as unsorted municipal waste. Collection of such waste separately for special treatment is necessary.

It is prohibited to dispose of this appliance in domestic household waste.

For disposal, there are several possibilities:

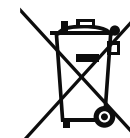

- A) The municipality has established collection systems, where electronic waste can be disposed of at least free of charge to the user.
- B) When buying a new product, the retailer will take back the old product at least free of charge.
- C) The manufacture will take back the old appliance for disposal at least free of charge to the user.
- D) As old products contain valuable resources, they can be sold to scrap metal dealers.

Wild disposal of waste in forests and landscapes endangers your health when hazardous substances leak into the ground-water and find their way into the food chain.





SAFETY PRECAUTIONS

To prevent injury to the user or other people and property damage, the following instructions must be followed. Incorrect operation due to ignoring of instructions may cause harm or damage. The seriousness is classified by the following indications.

 WARNING	This symbol indicates the possibility of death or serious injury.
 CAUTION	This symbol indicates the possibility of injury or damage to property.

■ Meanings of symbols used in this manual are as shown below.

	Never do this.
	Always do this.

WARNING

- | | | |
|--|---|--|
| <p>ⓘ Connect with the power properly.</p> <ul style="list-style-type: none"> • Otherwise, it may cause electric shock or fire due to excess heat generation. | <p>ⓘ Do not operate or stop the unit by switching on or off the power.</p> <ul style="list-style-type: none"> • It may cause electric shock or fire due to heat generation. | <p>ⓘ Do not damage or use an unspecified power cord.</p> <ul style="list-style-type: none"> • It may cause electric shock or fire. |
| <p>ⓘ Do not modify power cord length or share the outlet with other appliances</p> <ul style="list-style-type: none"> • It may cause electric shock or fire due to heat generation. | <p>ⓘ Do not operate with wet hands or in damp environment.</p> <ul style="list-style-type: none"> • It may cause electric shock. | <p>ⓘ Do not direct airflow at room occupants only.</p> <ul style="list-style-type: none"> • This could damage your health. |
| <p>ⓘ Always ensure effective earthing.</p> <ul style="list-style-type: none"> • No earthing may cause electric shock. | <p>ⓘ Do not allow water to run into electric parts.</p> <ul style="list-style-type: none"> • It may cause failure of machine or electric shock. | <p>ⓘ Always install circuit breaker and a dedicated power circuit.</p> <ul style="list-style-type: none"> • No installation may cause fire and electric shock. |
| <p>ⓘ Disconnect the power if strange sounds, smell, or smoke comes from it.</p> <ul style="list-style-type: none"> • It may cause fire and electric shock. | <p>ⓘ Do not drink water drained from air conditioner.</p> <ul style="list-style-type: none"> • It contains contaminants and could make you sick. | <p>ⓘ Do not open the unit during operation.</p> <ul style="list-style-type: none"> • It may cause electric shock. |
| <p>ⓘ Use the correctly rated breaker or fuse.</p> <ul style="list-style-type: none"> • There is risk of fire or electric shock. | <p>ⓘ Do not use the power cord close to heating appliances.</p> <ul style="list-style-type: none"> • It may cause fire and electric shock. | <p>ⓘ Do not disassemble or modify unit.</p> <ul style="list-style-type: none"> • It may cause failure and electric shock. |
| <p>ⓘ Ventilate room before operating air conditioner if there is a gas leakage from another appliance.</p> <ul style="list-style-type: none"> • It may cause explosion, fire and, burns. | <p>ⓘ Do not use the power cord near flammable gas or combustibles, such as gasoline, benzene, thinner, etc.</p> <ul style="list-style-type: none"> • It may cause an explosion or fire. | |

SAFETY PRECAUTIONS

CAUTION

- | | | |
|---|---|--|
| <p>ⓘ When the air filter is to be removed, do not touch the metal parts of the unit.</p> <ul style="list-style-type: none"> • It may cause an injury. | <p>ⓘ Do not clean the air conditioner with water.</p> <ul style="list-style-type: none"> • Water may enter the unit and degrade the insulation. It may cause an electric shock. | <p>ⓘ Ventilate the room well when used together with a stove, etc.</p> <ul style="list-style-type: none"> • An oxygen shortage may occur. |
| <p>ⓘ When the unit is to be cleaned, switch off, and turn off the circuit breaker.</p> <ul style="list-style-type: none"> • Do not clean unit when power is on as it may cause fire and electric shock, it may cause an injury. | <p>ⓘ Do not put a pet or house plant where it will be exposed to direct air flow.</p> <ul style="list-style-type: none"> • This could injure the pet or plant. | <p>ⓘ Do not use for special purposes.</p> <ul style="list-style-type: none"> • Do not use this air conditioner to preserve precision devices, food, pets, plants, and art objects. It may cause deterioration of quality, etc. |
| <p>ⓘ Stop operation and close the window in storm or hurricane.</p> <ul style="list-style-type: none"> • Operation with windows opened may cause wetting of indoor and soaking of household furniture. | <p>ⓘ Do not place obstacles around air-inlets or inside of air-outlet.</p> <ul style="list-style-type: none"> • It may cause failure of appliance or accident. | <p>ⓘ Turn off the main power switch when not using the unit for a long time.</p> <ul style="list-style-type: none"> • It may cause failure of product or fire. |
| <p>ⓘ Do not use strong detergent such as wax or thinner. Use a soft cloth for cleaning.</p> <ul style="list-style-type: none"> • Appearance may be deteriorated due to change of product color or scratching of its surface. | <p>ⓘ Ensure that the installation bracket of the outdoor appliance is not damaged due to prolonged exposure.</p> <ul style="list-style-type: none"> • If bracket is damaged, there is concern of damage due to falling of unit. | <p>ⓘ Always insert the filters securely. Clean filter once every two weeks.</p> <ul style="list-style-type: none"> • Operation without filters may cause failure. |
| <p>ⓘ Do not place heavy object on the power cord and take care so that the cord is not compressed.</p> <ul style="list-style-type: none"> • There is danger of fire or electric shock. | <p>ⓘ Use caution when unpacking and installing. Sharp edges could cause injury.</p> | <p>ⓘ If water enters the unit, turn the unit off and disconnect the power, contact a qualified service technician.</p> |

OPERATING INSTRUCTIONS

Parts names

Indoor unit

NOTE: The indoor unit you purchased would like one of the following. There is a slightly difference on front panel and display window, but the features are the same.

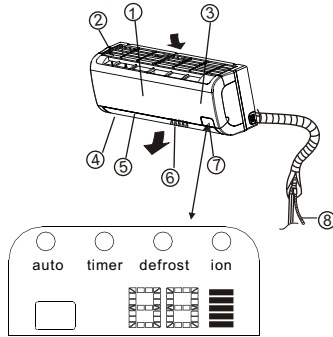

(A)

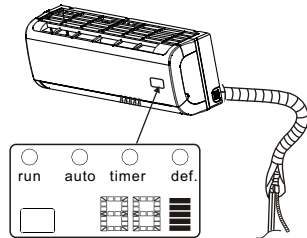

(B)

Outdoor unit

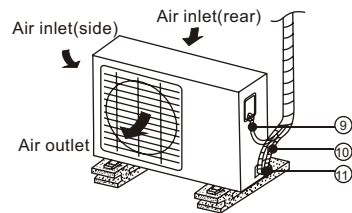

Indoor unit

1. Front panel
2. Air inlet
3. Air filter(under the panel)
4. Air outlet
5. Horizontal air flow grille
6. Vertical air flow louver(inside)
7. Display panel
8. Connecting pipe, drain hose

Outdoor unit

9. Connective cable
10. Connecting pipe
11. Stop valve

NOTE:
All the pictures in this manual are for explanation purpose only. Your air conditioner may be slightly different. The actual shape shall prevail.

OPERATING INSTRUCTIONS

Indicator Lights on Display panel

NOTE:The display panel of the indoor unit you purchased may be look like one of the following:

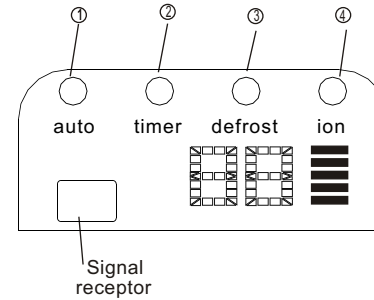

(A)

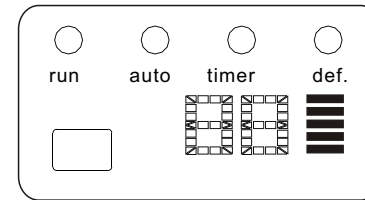

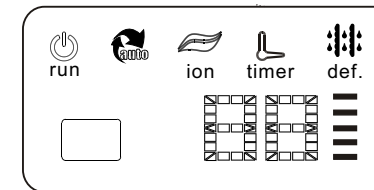

(B)



(C)

- ① **Auto indicator:**
This indicator illuminates when the air conditioner is in AUTO operation.
- ② **Timer indicator:**
This indicator illuminates when TIMER is set ON/OFF.
- ③ **Defrost Indicator**
(For cooling & heating model only):
This indicator illuminates when the air conditioner starts defrosting automatically or when the warm air control feature is activated in heating operation.
- ④ **Ion Indicator**
Lights up when Ion feature is activated and ionizer can generate abundant anions to fill the room with refreshing and natural air.
NOTE: This function is only available for air conditioner adopts Ionizer.

 **DIGITAL DISPLAY:**
Displays the current setting temperature and malfunction/protection code when the air conditioner is in operation. Displays the room temperature under fan only mode.

 **Frequency display:**
This display is separated into five zones. The zones illuminate based on the compressor current frequency. For example, higher frequency will illuminate more zones.

 **RUN indication lamp**
This lamp illuminates when the air conditioner is in operation.

 **AUTO indication lamp**
Lights up during the Auto operation.

 **Ion indication lamp(optional function)**
Lights up when Clean Air feature is activated and ionizer can generate abundant anions to fill the room with refreshing and natural air.

 **TIMER indication lamp**
Lights up during Timer operation.

 **DEFROST indication lamp**
(For cooling & heating models only):
Lights up when the air conditioner starts defrosting automatically or when the warm air control feature is activated in heating operation.

OPERATING INSTRUCTIONS

NOTE: This manual does not include Remote Controller Operations, see the <<Remote Controller Instruction>> packed with the unit for details.

Operating temperature

Mode	Cooling operation	Heating operation	Drying operation
Room temperature	$\geq 17^{\circ}\text{C}$ (62°F)	$\leq 30^{\circ}\text{C}$ (86°F)	$> 10^{\circ}\text{C}$ (50°F)
Outdoor temperature	$0^{\circ}\text{C} \sim 50^{\circ}\text{C}$ (32°F ~ 122°F)	$-15^{\circ}\text{C} \sim 30^{\circ}\text{C}$ (5°F ~ 86°F)	$0^{\circ}\text{C} \sim 50^{\circ}\text{C}$ (32°F ~ 122°F)
	$(-15^{\circ}\text{C} \sim 50^{\circ}\text{C}/5^{\circ}\text{F} \sim 122^{\circ}\text{F})$ For the models with low temperature cooling system)		

CAUTION:

1. If air conditioner is used outside of the above conditions, certain safety protection features may come into operation and cause the unit to function abnormally.
2. Room relative humidity less than 80%. If the air conditioner operates in excess of this figure, the surface of the air conditioner may attract condensation. Please set the vertical air flow louver to its maximum angle (vertically to the floor), and set HIGH fan mode.
3. Optimum performance will be achieved within these operating temperature.

Suggestion: For the unit adopts an Electric Heater, when the outside ambient temperature is below 0°C (32°F), we strongly recommend you to keep the machine plugged in order to guarantee it running smoothly.

Manual operation

Manual operation can be used temporarily in case the remote controller is disabled or maintenance necessary.

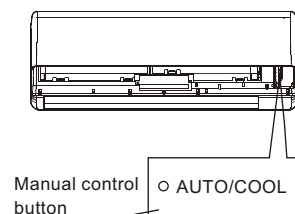
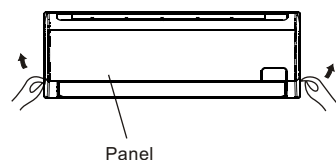

- NOTE:** The unit must be turned off before operating the manual control button. If the unit is operational, continue pressing the manual control button until the unit is off.
- ① Open and lift the front panel up to an angle until it remains fixed with a clicking sound.
 - ② One press of the manual control button will lead to the forced AUTO operation. If press the button twice within five seconds, the unit will operate under forced COOL operation.
 - ③ Close the panel firmly to its original position.

CAUTION:

- This button is used for testing purposes only. You had better not choose it.
- To restore the remote controller operation, use the remote controller directly.

OPERATING INSTRUCTIONS

Airflow direction control

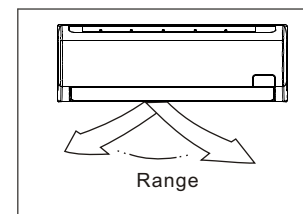
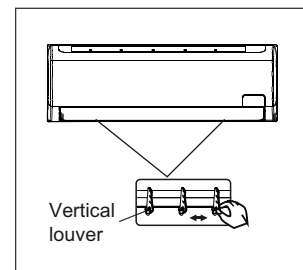
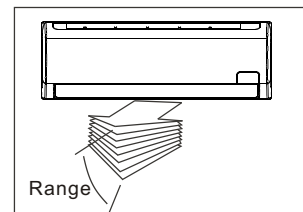

- Adjust the air flow direction properly otherwise, it might cause discomfort or cause uneven room temperatures.
- Adjust the horizontal louver using the remote controller.
- Adjust the vertical louver manually.

To set the vertical air flow (Up--Down) direction. Perform this function while the unit is in operation. Use the remote controller to adjust the air flow direction. The horizontal louver can be moved at a range of 6° for each press, or swing up and down automatically. Please refer to the 'REMOTE CONTROLLER OPERATION MANUAL' for details.

To set the horizontal air flow direction (left - right)

- Move the vertical louver manually to adjust the air flow in the direction you prefer.

- IMPORTANT:** Before adjusting the vertical louvers, the supply power must be disconnected.
- For some models, the vertical louver can be adjusted by using the remote controller. Please refer to the 'REMOTE CONTROLLER OPERATION MANUAL' for details.

CAUTION

- Do not operate the air conditioner for long periods with the air flow direction set downward in cooling or dehumidifying mode. Otherwise, condensation may occur on the surface of the horizontal louver causing moisture to drop on to the floor or on furnishings.
- Do not move the horizontal louver manually unless it is necessary. Always use the remote controller.
- When the air conditioner is started immediately after it was stopped, the horizontal louver might not move for approximately 10 seconds.
- Open angle of the horizontal louver should not be set too small, as COOLING or HEATING performance may be impaired due to too restricted air flow area.
- Do not operate unit with horizontal louver in closed position.
- When the air conditioner is connected to power (initial power), the horizontal louver may generate a sound for 10 seconds, this is a normal operation.

OPERATING INSTRUCTIONS

How the air conditioner works

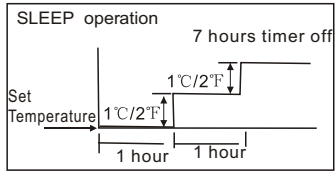

Cooling

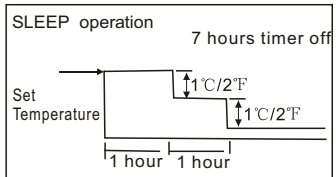

Heating

AUTO operation

- When you set the air conditioner in AUTO mode, it will automatically select cooling, heating (cooling/heating models only), or fan only operation depending on what temperature you have selected and the room temperature.
- The air conditioner will control room temperature automatically around the temperature point set by you.
- If the AUTO mode is uncomfortable, you can select desired conditions manually.

SLEEP operation

When you push SLEEP button on remote controller during cooling, heating (cooling & heating models only), or AUTO operation, the air conditioner will automatically increase (cooling) or decrease (heating) 1°C/2°F per hour for the first 2 hours, then hold steady for the next 5 hours, after that it will switch off. This characteristic maintains both energy saving and comfort in night operation.

DRYING operation

- The fan speed will be automatically controlled under dry operation.
- During the dry operation, if the room temperature is lower than 10°C (50°F), the compressor stops operation and restarts until the room temperature is above 12°C (54°F).

Optimal operation

- To achieve optimal performance, please note the following:
- Adjust the air flow direction correctly so that it is not directed on people.
- Adjust the temperature to achieve the highest comfort level. Do not adjust the unit to excessive temperature levels.
- Close doors and windows on COOL or HEAT modes, or performance may be reduced.
- Use TIMER ON button on the remote controller to select a time you want to start your air conditioner.
- Do not put any object near air inlet or air outlet, as the efficiency of the air conditioner may be reduced and the air conditioner may stop running.
- Clean the air filter periodically, otherwise cooling or heating performance may be reduced.
- Do not operate unit with horizontal louvre in closed position.

CARE AND MAINTENANCE

Care and maintenance

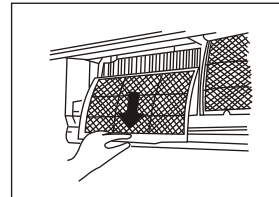
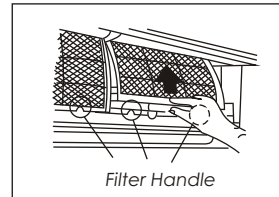
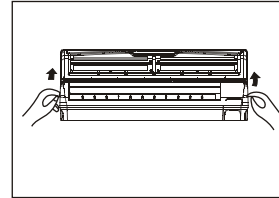

Cleaning the Grille, Case and Remote Controller

- Turn the system off before cleaning. To clean, wipe with a soft, dry cloth. Do not use bleach or abrasives.

NOTE: Supply power must be disconnected before cleaning the indoor unit.

CAUTIONS

- A cloth dampened with cold water may be used on the indoor unit if it is very dirty. Then wipe it with a dry cloth.
- Do not use a chemically treated cloth or duster to clean the unit.
- Do not use benzene, thinner, polishing powder, or similar solvents for cleaning. These may cause the plastic surface to crack or deform.
- Never use water hotter than 40°C/104°F to clean the front panel, it could cause deformation or discoloration.

Cleaning the air filter

A clogged air filter reduces the cooling efficiency of this unit. Please clean the filter once every 2 weeks.

1. Lift the indoor unit panel up to an angle until it stops with a clicking sound.
2. Take hold of the handle of the air filter and lift it up slightly to take it out from the filter holder, then pull it downwards.
3. Remove the AIR FILTER from the indoor unit.
 - Clean the AIR FILTER once two weeks.
 - Clean the AIR FILTER with a vacuum cleaner or water, then dry it up in cool place.

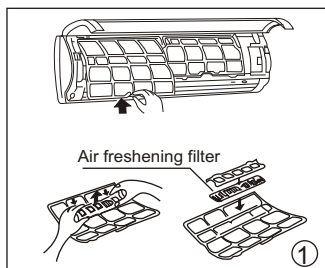

4. Remove the Air Freshening Filter from its support frame (on some models).
(The optional filter include :Plasma Dust Collector/ Silver Ion filter /Bio filter /Vitamin C filter/3M air purifier filter, etc. The removing and installation methods are slightly different, see the pictures marked ① and ② on the left.

 - Clean the air freshening filter at least once a month, and replace it every 4-5 months.
 - Clean it with vacuum cleaner, then dry it in cool place.

⚠ Do not touch the Plasma Dust Collector Filter within 10 minutes after opening the front panel, it may cause an electric shock.

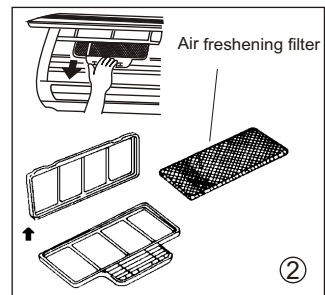

5. Install the air freshening filter back into position.
6. Insert the upper portion of air filter back into the unit, taking care that the left and right edges line up correctly and place filter into position.

Maintenance

If you plan to idle the unit for a long time, perform the following:

- (1) Operate the fan for about half a day to dry the inside of the unit.
- (2) Stop the air conditioner and disconnect power. Remove the batteries from the remote controller.
- (3) The outdoor unit requires periodic maintenance and cleaning. Do not attempt to do this yourself. Contact your dealer or servicer.

Checks before operation

- Check that the wiring is not broken off or disconnected.
- Check that the air filter is installed.
- Check if the air outlet or inlet is blocked after the air conditioner has not been used for a long time.

⚠ Caution

- Do not touch the metal parts of the unit when removing the filter. Injuries can occur when handling sharp metal edges.
- Do not use water to clean inside the air conditioner. Exposure to water can destroy the insulation, leading to possible electric shock.
- When cleaning the unit, first make sure that the power and circuit breaker are turned off.

The following events may occur during normal operation.

1. Protection of the air conditioner.

Compressor protection

- The compressor can't restart for 3 minutes after it stops.
- Anti-cold air** (Cooling and heating models only)
 - The unit is designed not to blow cold air on HEAT mode, when the indoor heat exchanger is in one of the following three situations and the set temperature has not been reached.
 - A) When heating has just starting.
 - B) Defrosting.
 - C) Low temperature heating.
 - The indoor or outdoor fan stop running when defrosting (Cooling and heating models only).
- Defrosting** (Cooling and heating models only)
 - Frost may be generated on the outdoor unit during heat cycle when outdoor temperature is low and humidity is high resulting in lower heating efficiency of the air conditioner.
 - During this condition air conditioner will stop heating operation and start defrosting automatically.
 - The time to defrost may vary from 4 to 10 minutes according to the outdoor temperature and the amount of frost build up on the outdoor unit.

2. A white mist coming out from the indoor unit

- A white mist may generate due to a large temperature difference between air inlet and air outlet on COOL mode in an indoor environment that has a high relative humidity.
- A white mist may generate due to moisture generated from defrosting process when the air conditioner restarts in HEAT mode operation after defrosting.

3. Low noise of the air conditioner

- You may hear a low hissing sound when the compressor is running or has just stopped running. This sound is the sound of the refrigerant flowing or coming to a stop.
- You can also hear a low "squeak" sound when the compressor is running or has just stopped running. This is caused by heat expansion and cold contraction of the plastic parts in the unit when the temperature is changing.
- A noise may be heard due to louver restoring to its original position when power is first turned on.

4. Dust is blown out from the indoor unit.

This is a normal condition when the air conditioner has not been used for a long time or during first use of the unit.

5. A peculiar smell comes out from the indoor unit.

This is caused by the indoor unit giving off smells permeated from building material, from furniture, or smoke.

6. The air conditioner turns to FAN only mode from COOL or HEAT (For cooling and heating models only) mode.

When indoor temperature reaches the temperature setting on air conditioner, the compressor will stop automatically, and the air conditioner turns to FAN only mode. The compressor will start again when the indoor temperature rises on COOL mode or falls on HEAT mode (For cooling and heating models only) to the set point.

OPERATION TIPS

7. Dripping water may generate on the surface of the indoor unit when cooling in a high relatively humidity (relative humidity higher than 80%). Adjust the horizontal louver to the maximum air outlet position and select HIGH fan speed.
8. Heating mode (For cooling and heating models only)
The air conditioner draws in heat from the outdoor unit and releases it via the indoor unit during heating operation. When the outdoor temperature falls, heat drawn in by the air conditioner decreases accordingly. At the same time, heat loading of the air conditioner increases due to larger difference between indoor and outdoor temperature. If a comfortable temperature can't be achieved by the air conditioner, we suggest you use a supplementary heating device.
9. Auto-restart function
Power failure during operation will stop the unit completely.
- For the unit without Auto-restart feature, when the power restores, the OPERATION indicator on the indoor unit starts flashing. To restart the operation, push the ON/OFF button on the remote controller. For the unit with Auto-restart feature, when the power restores, the unit restarts automatically with all the previous settings preserved by the memory function.
 - For some models, the machine is special designed with Auto-restart function for the open angle of the horizontal louver. Power failure during operation or pressing the ON/OFF button on the remote controller will stop the unit completely. When the power restores or pressing the ON/OFF button on the remote controller again, the unit restarts automatically with all the previous settings including the open angle of the horizontal louver by the memory function. So we strongly suggest that the open angle of the horizontal louver should not be set too small, in case the condensed water forms and drops from the horizontal louver. Press the AUTO/COOL button under the front panel and the open angle of the horizontal louver will be restored to the standard angle when the condensed water forms on the horizontal louver.
10. Lightning or a car wireless telephone operating nearby may cause the unit to malfunction. Disconnect the unit with power and then re-connect the unit with power again. Push the ON/OFF button on the remote controller to restart operation.
11. **The protection of outdoor low temperature (on some models)**
The protection of outdoor low temperature can be activated only in the HEATING mode. The unit will stop operating and display "P3" on the LCD window of the indoor unit when the outdoor temperature is or lower than 5°F (-15°C) for one hour, but the indoor unit in this situation can still receive the signal from the remote controller. The unit will restart automatically with all the previous settings preserved by the memory function when the outdoor temperature is or higher than 11°F (-12°C) for 10 minutes and the compressor stop operating for more than one hour, or when the outdoor temperature is or higher than 41°F (5°C) for 10 minutes.

TROUBLESHOOTING TIPS

Troubleshooting Tips

If one of the following faults occurs, stop the air conditioner immediately, disconnect the power and then connect it in again. If the problem still exists, disconnect the power and contact the nearest customer service center.	
Trouble	OPERATION/RUN indicator or other indicators continue flashing.
	Fuse blows frequently or circuit breaker trips frequently.
	Other objects or water fall into the air conditioner.
	The remote controller won't work or works abnormally.
If one of the following code appears on the display area : E0,E1,E2,E3.....or P0,P1,P2,P3.....	

Malfunctions	Cause	What should be done?
Unit does not start	Power cut	Wait for power to be restored.
	Unit may have become unplugged.	Check that plug is securely in wall receptacle.
	Fuse may have blown.	Replace the fuse.
	Battery in Remote controller may have been exhausted.	Replace the battery.
	The time you have set with timer is incorrect.	Wait or cancel timer setting.
Unit not cooling or heating (Cooling/ heating models only) room very well while air flowing out from the air conditioner	Inappropriate temperature setting.	Set temperature correctly. For detailed method please refer to "Using remote control" section.
	Air filter is blocked.	Clean the air filter.
	Doors or Windows are open.	Close the doors or windows.
	Air inlet or outlet of indoor or outdoor unit has been blocked.	Clear obstructions away first, then restart the unit.
	Compressor 3 minutes protection has been activated.	Wait.
If the trouble has not been corrected, please contact a local dealer or the nearest customer service center. Be sure to inform them of the detailed malfunctions and unit model.		

**Notes: Do not attempt to repair the unit yourself.
Always consult an authorised service provider.**