



User's Manual

WHS-87LW1/WHS-87LB1/WHS-87LSS1

Before using your product, please read this manual carefully and keep it for future reference.



CONTENTS



■ Safety warnings	
Meaning of safety warning symbols	2
Related warnings for use	2
Electricity related warnings	2
Warnings related to placing items	3
Warnings related to disposal	3
■ Proper use of refrigerators	
Names of components	4
Thermostat	5
placement	5
Start	5
■ Maintenance of refrigerators	
Cleaning	6
Defrost	6
Stop using	6
■ Frequently asked questions	
■ Door install guidelines about swapping left&right	

DEAR CUSTOMER:

Thank you for buying this refrigerator-freezer. To ensure that you get the best results from your new refrigerator-freezer, please take time to read through the simple instructions in this booklet. Please ensure that the packing material is disposed of in accordance with the current environmental requirements.
When disposing of any refrigerator-freezer equipment please contact your local waste disposal department for advice on safe disposal.
This appliance must be only used for its intended purpose.

Safety warnings

► Meaning of safety warning symbols

	The symbols indicate prohibited matters, and those behaviors are forbidden. Non-compliance with the instructions may result in product damages or endanger the personal safety of users.
	The symbols indicate matters that must be followed, and those behaviors must be strictly executed in line with the operation requirements. Non-compliance with the instructions may result in product damages or endanger the personal safety of users.
	The symbols indicate matters to pay attention to, and these behaviors shall be specially noted. Due precautions are needed or minor or moderate injuries or damages of the product will be caused.

CAUTION :

The appliance is not intended for use by young children or infirm persons without supervision.

Young children should be supervised to ensure that they do not play with the appliance.

GENERAL:

This type of refrigerator-freezer is widely used in places such as hotels ,offices, student dormitories and houses. It is mostly suitable for refrigerating and preserving foods such as fruits and beverage. It enjoys the advantages of small size, Lightweight, Low electric consumption and easy use.

This manual contains lots of important safety information which shall be observed by the users.

Safety warnings

► Electricity related warnings

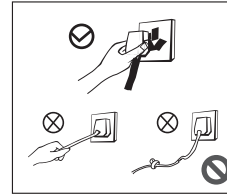

- Do not pull the power cord when pulling the power plug of the refrigerator. Please firmly grasp the plug and pull out it from the socket directly.
- Do not damage the power cord under any condition so as to ensure safety use, do not use when the power cord is damaged or the plug is worn.
- Worn or damaged power cord shall be replaced in manufacture-authorized maintenance stations.



- Please use a dedicated three-hole power socket which is 10A or more and the power socket shall not be shared with other electrical appliances.
- The power cord should be firmly contacted with the socket or else fires might be caused. Please ensure that the grounding electrode of the power socket is equipped with a reliable grounding line.



- The refrigerator adopts 115V/60Hz AC power, voltage fluctuations over the range of $115 \pm 10\%$ V will cause malfunction or even damage, so a 750 W automatic voltage regulator must be installed in concert with the AC power.
- Please turn off the valve of the leaking gas and then open the doors and windows in case of leakage of gas and other flammable gases. Do not unplug the refrigerator and other electrical appliances considering that spark may cause a fire.

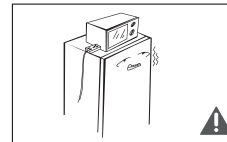

- To ensure safety, it is not recommended that to place regulators, rice cookers, microwave ovens and other appliances at the top of the refrigerator, those recommended by the manufacture are not included. Do not use electrical appliances in the food pantry.

► Related warnings for use

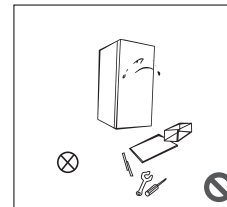

- Authorized demolition or renovation of the refrigerator is not prohibited. It is forbidden to damage the refrigerant lines and the repair and maintenance of the refrigerator must be carried out by professionals.
- Damaged power cord must be replaced by the manufacturer, its maintenance department or related professionals in order to avoid danger.

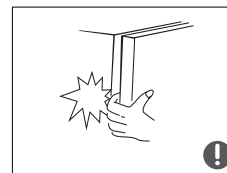

- The surrounding of the appliances around or the embedded structure shall not be obstructed while good ventilation shall be maintained.
- The gaps between refrigerator doors and between doors and refrigerator body are small, be noted not to put your hand in these areas to prevent squeezing the finger. Please be gentle when switching off the refrigerator door to avoid falling articles.
- Do not pick foods or containers in the freezing chamber when the refrigerator is running, especially metal containers in order to avoid frostbite.

Safety warnings



- Do not allow children to enter or climb the refrigerator to prevent that children are sealed in the refrigerator or children are injured by the falling refrigerator.
- Do not spray or wash the refrigerator; do not put the refrigerator in moist places easy to be splashed with water so as not to affect the electrical insulation properties of the refrigerator.

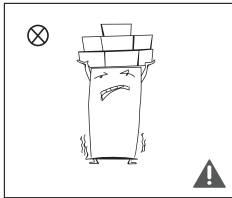

- Do not place heavy objects on the top of the refrigerator considering that objectives may fall when switching the door, and accidental injuries might be caused.
- Please pull of the plug in case of power failure or cleaning. Do not connect the freezer to power supply within five minutes to prevent damages to the compressor due to successive starts.

Warnings related to placing items

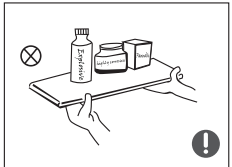

- Do not put flammable, explosive, volatile and highly corrosive items in the refrigerator to prevent damages to the product or fire accidents.
- Do not place flammable items near the refrigerator to avoid fires.

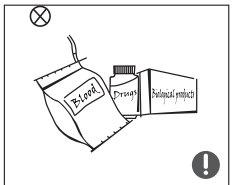

- This product is household refrigerators and shall be only suitable for the storage of foods. According to national standards, household refrigerators shall not be used for other purposes, such as storage of blood, drugs or biological products.



- Do not place items such as bottled or sealed container of fluid such as bottled beers and beverages in the freezer to prevent bursts and other losses.

Warnings related to disposal

The refrigerator's R134a refrigerant and cyclopentane foam materials are combustible materials and discarded refrigerators should be isolated from fire sources and can not be burned. Please transfer the freezer to qualified professional recycling companies for processing to avoid damages to the environment or other hazards.

- Please remove the door of the refrigerator and shelves which shall be properly placed to avoid accidents of children entering and playing in the refrigerator.

Proper use of refrigerators

Names of components

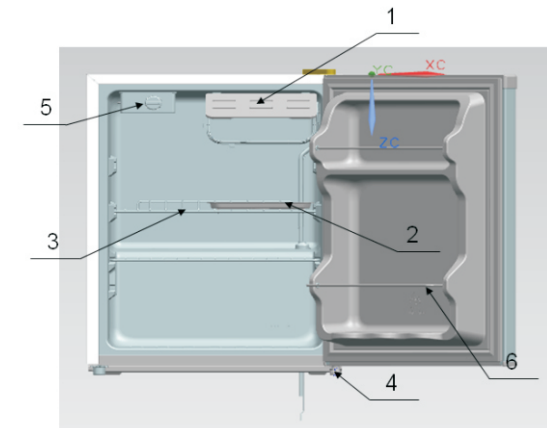

1.Small door 2.Pan, drain 3.Steel wire shelf
4.Leveler, leg 5.Thermostat 6.Wire steel bar

Refrigerating chamber

- The Refrigerating Chamber is suitable for storage of a variety of fruits, vegetables, beverages and other food consumed in the short term.
- Cooking foods shall not be put in the refrigerating chamber until cooled to room temperature.
- Foods are recommended to be sealed up before putting into the refrigerator.
- The glass shelves can be adjusted up or down for a reasonable amount of storage space and easy use.

The features and accessories of the refrigerator you bought may be not entirely consistent with the legend, please refer to the packing list.

Proper use of refrigerators

► Thermostat

- The temperature selector knob is located on the right hand side wall of the refrigerator interior
Setting “Off” : UnitOff
Setting “Min” : Less Cool Temperature
Setting “Med” : Normal Operation(adequate for most situations)
Setting “Max” : Coolest Temperature
- During high ambient temperatures e.g. on hot summer days. It may be necessary to set the thermostat to the Coolest setting(position “Max”).This may cause the compressor running continuously in order to maintain a low temperature in the cabinet.
- **For the first time you install your refrigerator, set the thermostat knob at “Med” .** Give your refrigerator time to cool down completely before adding food. It is the best to wait 24 hours before adding food. The thermostat knob controls the temperature. When the thermostat control knob is set to **OFF**, the refrigerator will not be running.

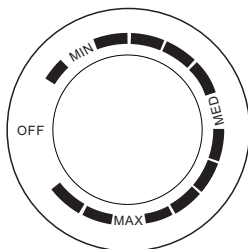

► Placement

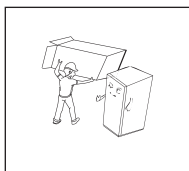

- Before using the refrigerator, remove all packaging materials including bottom cushions and foam pads and tapes inside the refrigerator, tear off the protective film on the door and the refrigerator body.

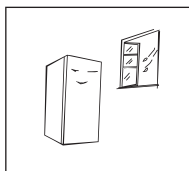

- The refrigerator is placed in a well-ventilated indoor place; the ground shall be flat, and sturdy (rotate left or right to adjust the wheel for leveling if unstable).

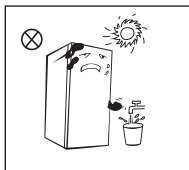

- Keep away from heat and avoid direct sunlight. Do not place the freezer in moist or watery places to prevent rust or reduction of insulating effect.

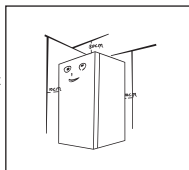

- The top space of the refrigerator shall be greater than 30cm, and the distances from both sides and backside shall be more than 10 cm to facilitate the opening and closing and heat dissipation.
- Wipe the refrigerator inside and outside with warm moist rag (add a small amount of detergent in the warm water and wipe clean finally with clean water).

► Start

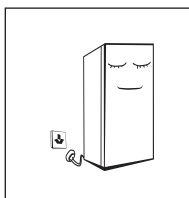

- The refrigerator shall stay for half an hour before connecting 115V/60Hz power when it is firstly started.
- The refrigerator shall run 2 to 3 hours before loading fresh or frozen foods; the refrigerator shall run for more than 4 hours in summer in advance considering that the ambient temperature is high.

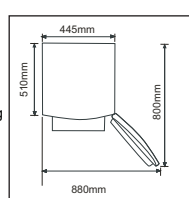

- Please leave enough space to ensure feasible opening and drawer removal.
- Dimensions shown are for reference only.

5

Maintenance of refrigerators

► Cleaning

- Dusts behind the refrigerator and on the ground shall be timely cleaned to improve the cooling effect and energy saving. The interior of the refrigerator should be cleaned regularly to avoid odor. Soft towels or sponge dipped in water and non-corrosive neutral detergents are suggested for cleaning. The freezer of shall be finally cleaned with clean water and dry cloth. Open the door for natural drying before the power is turned on.



- Do not use hard brushes, clean steel balls, wire brushes, abrasives, such as toothpastes, organic solvents (such as alcohol, acetone, banana oil, etc.), boiling water, acid or alkaline items clean refrigerator considering that this may damage the fridge surface and interior.
- Do not rinse with water so as not to affect the electrical insulation properties. Please use a dry cloth when cleaning lighting lamps, temperature control knob and electrical components.

⚠ Please unplug the refrigerator for defrost and cleaning.

► Defrost

- Defrost the freezing compartment whenever the layer of frost on the surface of the evaporator reaches 3 or 4 mm. When defrosting remove all food and set the thermostat at “OFF” position. Put the drip tray under the evaporator to collect melted water. After the frost has melted, discard the melted water and dry up the interior of refrigerator. The refrigerator can then be restarted by turning its thermostat to the desired setting.

⚠ Do not use metal utensils or electric heater for defrost so as not to damage the appliance. Please remove the food and put in a cool place when defrosting before removing drawers and other accessories.

► Stop using

Foods can be preserved for a couple of hours even in summer in case of power failure; it is recommended to reduce the frequency of opening door and do not put fresh foods into the freezer.

Please unplug the refrigerator left unused for a long time for cleaning. Keep the door open to avoid the bad odor.

Before moving the refrigerator, please remove all items in the refrigerator and fasten the glass partitions, fruit and vegetable boxes, freezer drawers with taps lest the door opens during displacement; Do not turn upside, horizontally place or vibrate the refrigerator, the carrying angle can not be greater than 45 °C.

⚠ Continuous operation is recommended when the refrigerator is started. Please do not move the refrigerator under normal circumstances so as not to affect the refrigerator's service life.

6

Frequently asked questions

- The following simple issues can be handled by the user. Please call the after-sale service department if the issues are not settled.

Inoperation	Whether the freezer is plugged and connected to power; Low voltage; Failure power or tripping circuit
Odor	Odorous foods should closely wrapped; Whether foods are rotten; Whether the interior shall be cleaned.
Foods in the refrigerating chamber are frozen	Whether the thermostat is over adjusted; Whether foods containing water is put in inside the glass partition.
Long-term operation of compressor	It is normal that refrigerator operates for longer time in summer when the ambient temperature is higher; Do not put too much food in the freezer at one time; Do not put foods until they are cooled; Frequent opening of refrigerator door. Thick frost layer (defrost is needed)
The refrigerator door can not be properly closed.	The freezer door is stuck by food packages; Too much food; Tilt refrigerator.
Loud noises	Whether the food is leveled, whether the refrigerator is balanced; Whether the refrigerator parts are properly placed.

Warm tips:

- ◆ The refrigerator enclosure may emit heat during operation specially in summer, this is caused by the radiation of the condenser, and it is a normal phenomenon.
- ◆ Condensation: condensation phenomenon will be detected on the exterior surface and door seals of the freezer when the ambient humidity is large, this is a normal phenomenon, and the condensation can be wiped away with a dry towel.
- ◆ Airflow sound: Refrigerants circulating in the refrigerant lines will produce eruption of sound and grunts which is normal does not affect the cooling effect.
- ◆ Buzz: Buzz will be generated by running compressor specially when starting up or shutting down.
- ◆ Clatter: The solenoid valve or electric switch valve will clatter which is a normal phenomenon and does not affect the operation.
- ◆ The refrigerating chamber will periodically frost and defrost (water drops will be generated on the backside of the refrigerating chamber when defrosting) which are normal.

Reversing The Door Swing

Caution: To avoid injury to yourself and/or property, we recommend someone assist you during the door reversal process.

- Ensure the appliance is unplugged and empty.
- Adjust the two leveling feet to their highest position.
- We recommend you have someone to assist you.

Tools required

- Cross-bladed screw driver

NOTE:

To take the door off it is necessary to tilt the appliance backward. You should rest the appliance on something solid e.g. a chair just below the top panel so you can access the bottom of the refrigerator.

DO NOT lay the appliance completely flat as this may damage the coolant system.

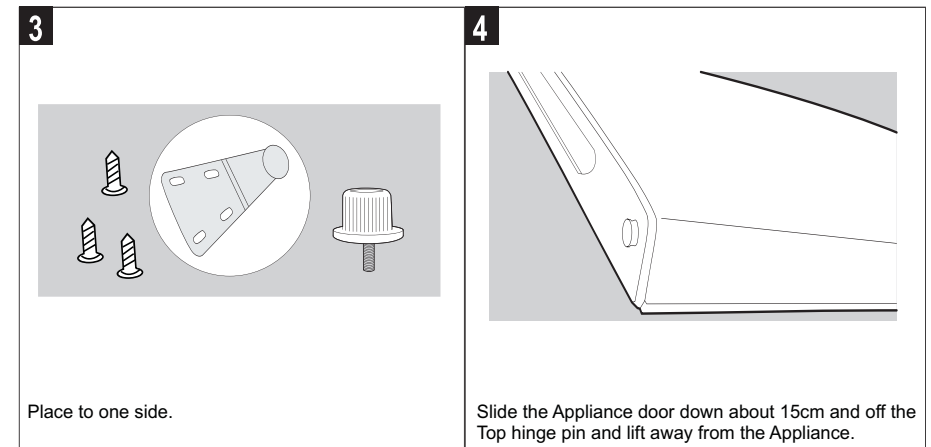
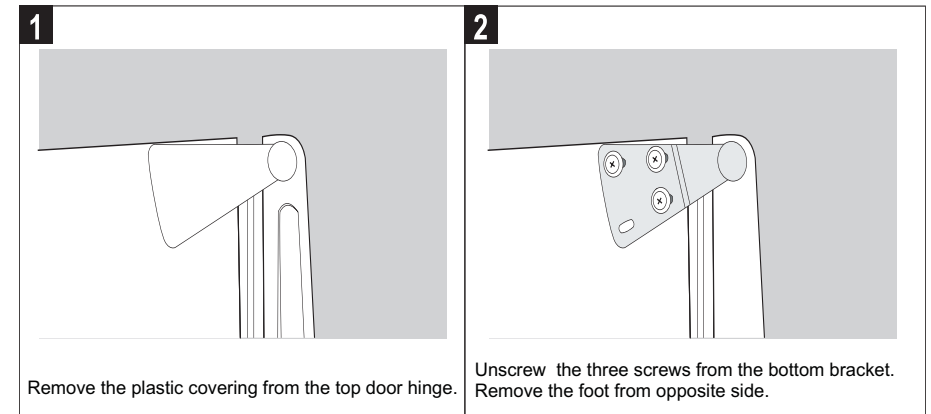

Reversing The Door Swing

5

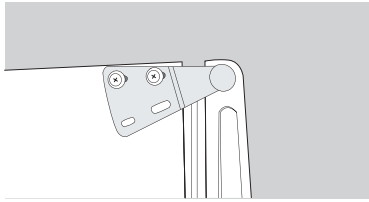

Remove the two screws from top bracket and replace on the other side. You will need to first remove the plastic caps from the other side.

6

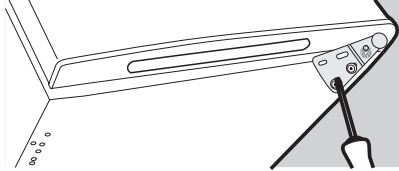

Slide the Appliance door back on to the Top hinge, making sure it's the right way up. Screw the bottom hinge into place on the new side. Replace the other foot on the other side. Replace the plastic covering by clicking back into position on the door hinge.

7

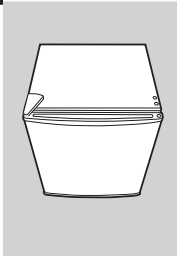

Check that the door is aligned horizontally and vertically and that the seals are closed on all sides before finally tightening the bottom hinge. Re-adjust the levelling feet.

RECOMMENDATIONS:

- 1) **WARNING** Keep ventilation openings, in the appliance enclosure or in the built-in structure, clear of obstruction.
- 2) **WARNING** Do not damage the refrigerant circuit.
- 3) **WARNING** Do not use electrical appliances inside the food storage compartments of the appliance, unless they are of the type recommended by the manufacturer.
- 4) The appliance has to be unplugged after use and before carrying out user maintenance on the appliance.
- 5) This appliance is not intended for use by persons (including children) with reduced physical, sensory or mental capabilities, or lack of experience and knowledge, unless they have been given supervision or instruction concerning use of the appliance by a person responsible for their safety.
- 6) Children should be supervised to ensure that they do not play with the appliance.
- 7) If the supply cord is damaged, it must be replaced by the manufacturer, its service agent or similarly qualified persons in order to avoid a hazard.
- 8) Please abandon the refrigerator-freezer according to local regulators for its use flammable blowing gas and refrigerant.
- 9) Please according to local regulations regarding disposal of the appliance for its flammable refrigerant and blowing gas. Before you scrap the appliance, please take off the doors to prevent children trapped.



Correct Disposal of this product:

This marking indicates that this product should not be disposed with other household wastes throughout the EU. To prevent possible harm to the environment or human health from uncontrolled waste disposal, recycle it responsibly to promote the sustainable reuse of material resources. To return your used device, please use the return and collection systems or contact the retailer where the product was purchased. They can take this product for environmental safe recycling.

For more information, please visit our website
www.midea.com

