



**Important Notes:**

Please read all the instructions before contacting customer support.

Please contact customer support before returning the product, we will reply the first time.

Customer Support:

Email: [service@ardwolf.com](mailto:service@ardwolf.com)

Web site: [www.ardwolf.com](http://www.ardwolf.com)



**Ardwolf A10 Fingerprint Touchscreen Door Lock  
User Manual**

## Content

1. Features -----	3
2. Specifications -----	4
3. How to scan your fingerprint -----	4
4. Flow chart of menu -----	5
5. Rule of operation-----	5
6. Enroll fingerprint-----	5
7. Delete Fingerprint-----	6
8. Delete all fingerprint -----	6
9. Add User Code -----	6
10. Delete User Code -----	7
11. Delete All User Code -----	7
12. Set up date and time-----	8
13. Set up Verify Mode-----	8
14. Set up Beep sound-----	8
15. Check user information -----	8
16. Change administrator code -----	8
17. Reset system -----	9
18. Audit Trail log -----	9
19. Passage mode enabling/disabling -----	9
20. Key unlock -----	9
21. Low battery alert -----	9
22. Additional power source -----	9
23. System reset -----	9
24. Troubleshooting -----	10
25. Installation -----	11

## Ardwolf A10 Fingerprint Touchscreen Door Lock User Manual



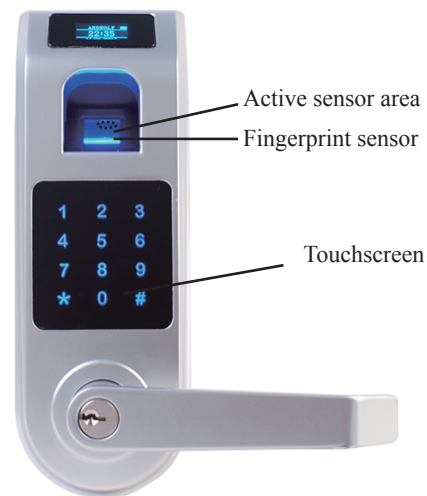

Thank you for choosing Ardwolf A10 fingerprint touchscreen door lock. No more worries about losing your keys, one touch to unlock. The fingerprint sensor in the lock is combined with the touch active sensor. This feature allows an easy and fast fingerprint entry--one touch on the fingerprint sensor unlocks. The lock has self-learning ability, which enables the lock to update a user fingerprint template after every fingerprint entry. This unique feature significantly reduces rejection rate when compared to other fingerprint lock systems on the market. The lock is equipped with OLED display, it makes visual menu based operation become true. Audit Trail feature allow lock owner to track entry record. Double verification feature increase lock security level significantly. Enjoy adopted the latest biometric fingerprint technologies that bring you a convenient and secure lock system.

### 1. Features

- Unlock by fingerprint, code, fingerprint + code, fingerprint + fingerprint or key.
- Up to 500 fingerprint users could be enrolled in the system.
- Up to 300 user codes could be programmed into the system.
- Visual menu display on OLED, it makes operation easy.
- Store up to 16384 audit trail logs.
- Individual fingerprint user and user code deletion.
- Build-in touch active sensor: one touch to unlock.
- Self-learning ability: fingerprint template is updated after every fingerprint entry.
- Two ways to login the system: programming code or administrator fingerprint.
- Beeper sound turn off option, you may turn off beeper sound if you don't like.

- Double verification mode: unlock by User code + fingerprint or fingerprint + different fingerprint, when you enable this mode.
- Support passage mode: stay at "unlock" state during the passage mode.
- Memory function: "power run-out" or "system reset" will not cause the loss of enrolled fingerprint(s) and user code(s).
- Reversible lever: lock fits both left-handed and right-handed door.
- Reversing lever controlled by key.
- "Schlage C key" as an override key.
- 9V battery may be attached as an additional power source.
- Double-shell heavy duty construction design.
- OLED show battery level and low battery alert.

### 2. Specifications

- Optical sensor.
- Touchscreen virtual 12-key keypad.
- Single latch.
- Adjustable backset 2 3/8" or 2 3/4".
- Fit door thickness between 1 3/8" and 2 3/8".
- Operation temperature from -22°F (-30°C) to 151°F (66°C).
- All weather door lock.
- Powered by 4 AA Alkaline batteries (NOT included).
- Lock designed for INTERIOR door ONLY.
- One year limited manufacturer's warranty.

### 3. How to scan your fingerprint

When placing your finger on the fingerprint sensor to scan, make sure that the location of the fingerprint “core” is making direct contact with fingerprint sensor. Apply medium pressure, or just enough to flatten the skin on your finger.

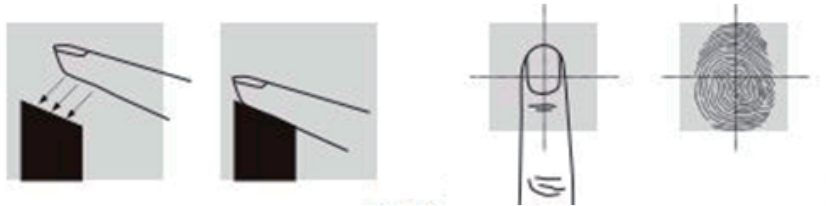

The fingerprint sensor won't get your fingerprint image if you take the following way.

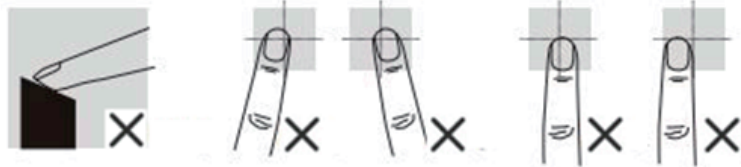

We recommend that you register index finger, thumb or finger with visible fingerprint image. It is important that your finger be clean when registering or verifying with your fingerprint. Washing your hands with moisturizing soap and using hand lotion will also improve accuracy. The fingerprint scanner scan fingerprint 2 to 3 times, user must lift finger and place back between scanning.

### 4. Flow chart of menu

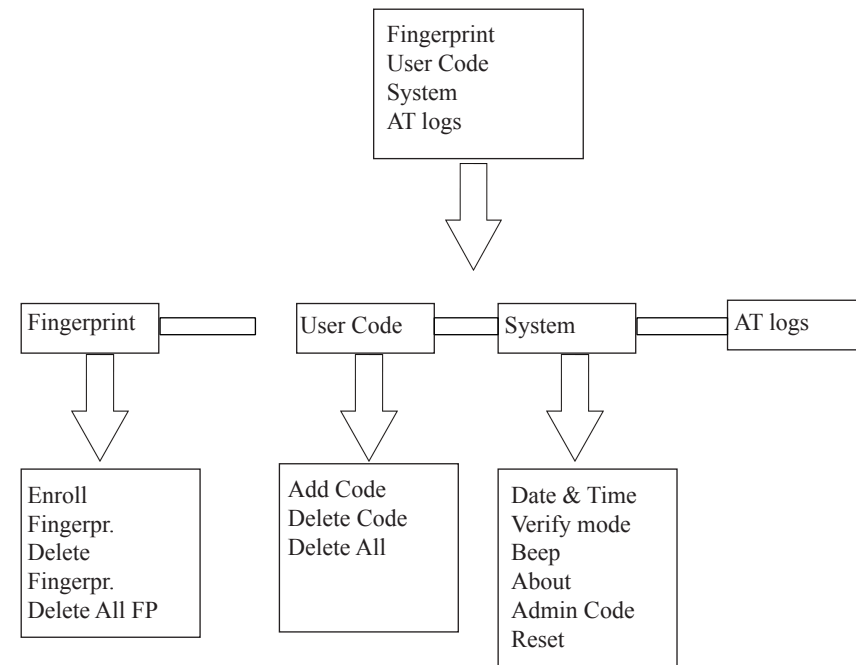

### 5. Rule of operation

Active lock by touching screen then touch #. Login page will show up. Login system by Admin Code or Admin Fingerprint. After login system, following Menu to program fingerprint, user code or set up lock. Default administrator code(1234).

Note: “2↑” stand for touching 2 to scroll cursor up. “8↓” stand for touching 8 to scroll cursor down. “#Enter” stand for touching # to confirm.

### 6. Enroll fingerprint

Login system, enter menu page (refer page 5 “5. Rule of operation”).

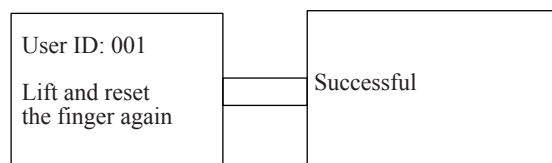
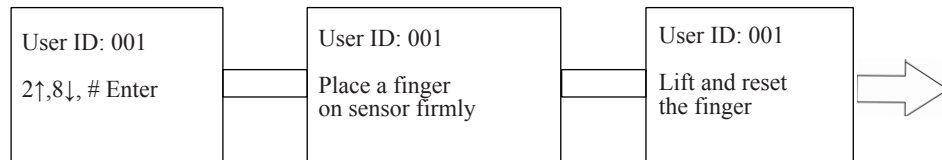
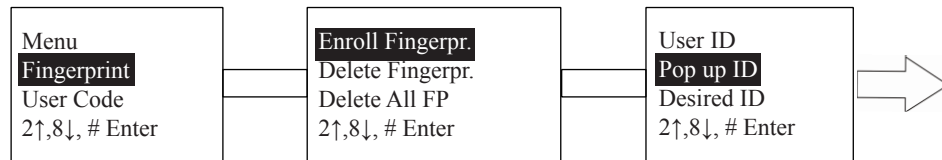

User could input a desired ID

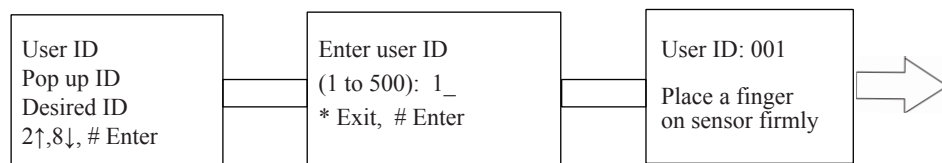

### 7. Delete Fingerprint

Login system, enter menu page (refer page 5 “5. Rule of operation”).

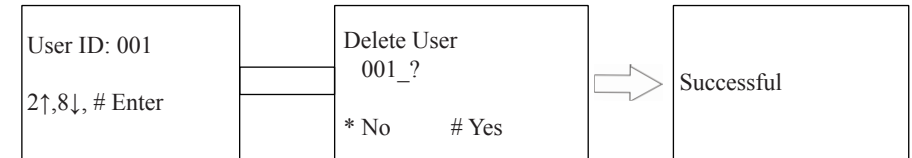
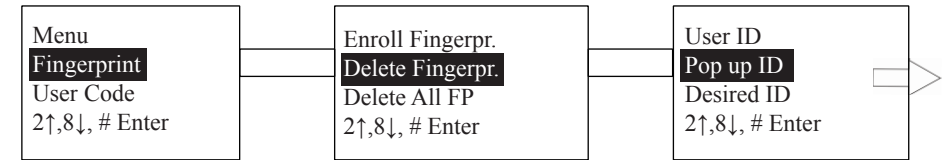

User could input a desired ID

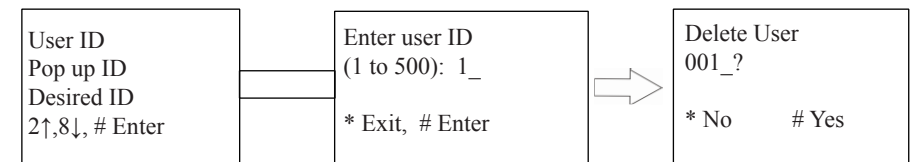

### 8. Delete all fingerprint

Login system, enter menu page (refer page 5 “5. Rule of operation”).

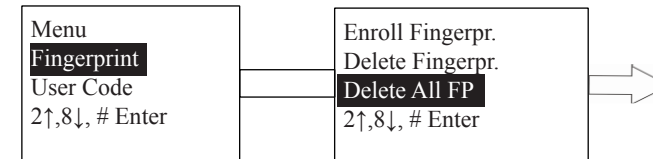

### 9. Add User Code

Login system, enter menu page (refer page 5 “5. Rule of operation”).

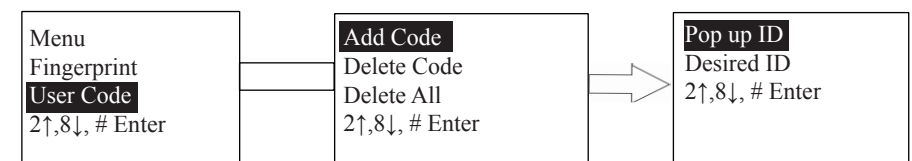

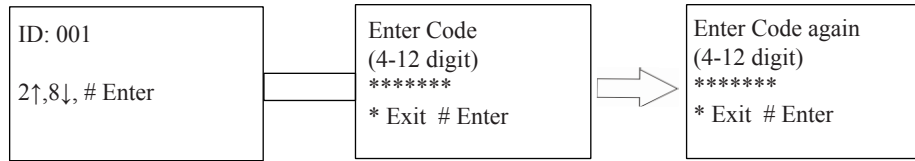

User could input a desired ID

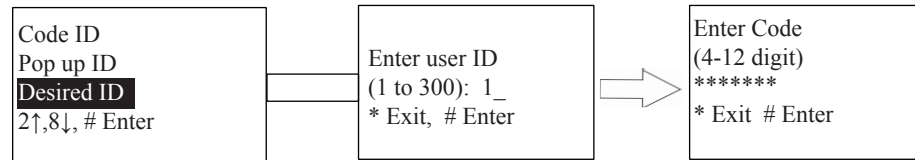

#### 10. Delete User Code

Login system, enter menu page (refer page 5 “5. Rule of operation”).

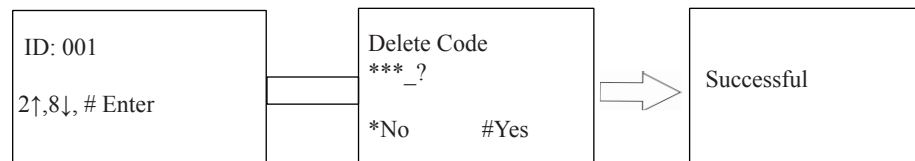
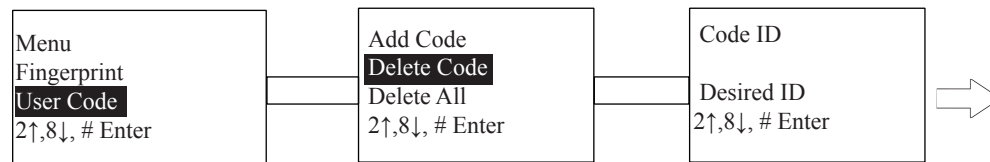

System allow user input a desired ID

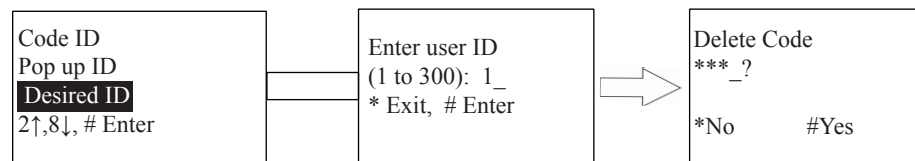

#### 11. Delete All User Code

Login system, enter menu page (refer page 5 “5. Rule of operation”).

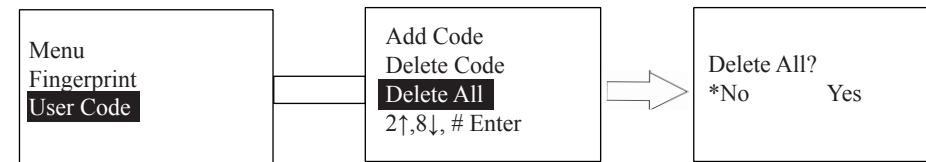

#### 12. Set up date and time

Login system, enter menu page (refer page 5 “5. Rule of operation”).

Input number, the default number will be replaced.

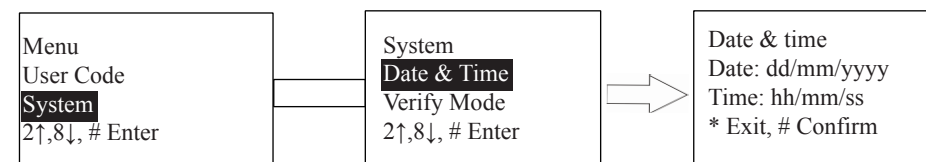

#### 13. Set up Verify Mode

Login system, enter menu page (refer page 5 “5. Rule of operation”).

There are three different verify mode, fingerprint or user code, fingerprint + code and fingerprint + fingerprint, You may pick up one that you want.

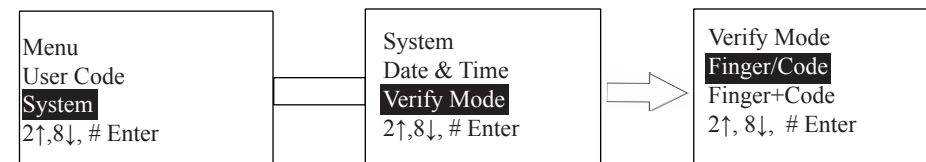

#### 14. Set up Beep sound

Login system, enter menu page (refer page 5 “5. Rule of operation”).

You may turn on or off sound.

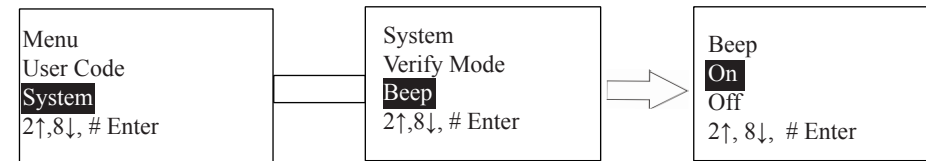

### 15. Check user information

Login system, enter menu page (refer page 5 “5. Rule of operation”).  
You may check user information in the system.

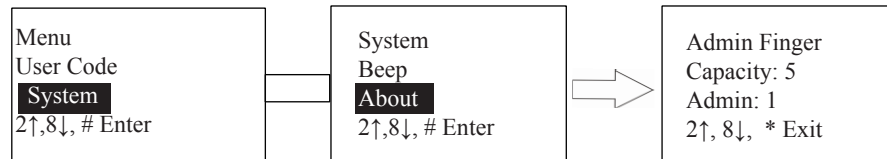

### 16. Change administrator code

Login system, enter menu page (refer page 5 “5. Rule of operation”).  
Please change default administrator code after you set up lock.

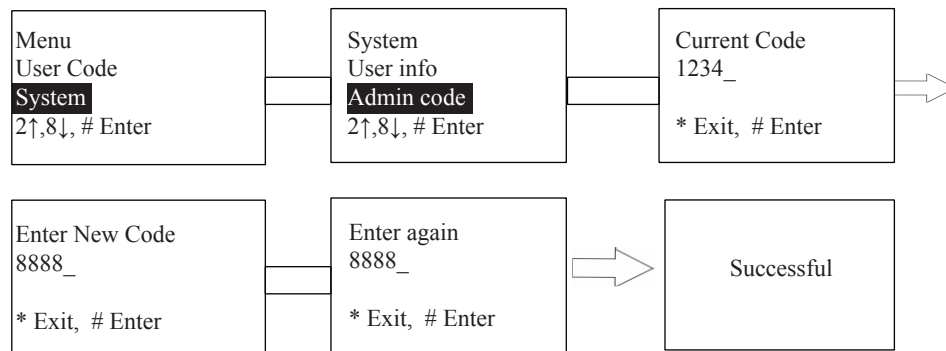

### 17. Reset system

Login system, enter menu page (refer page 5 “5. Rule of operation”).  
You may reset system to manufacture default. All audit logs will be removed after reset but all fingerprint and user code will remain in system. You may use delete all command to remove all finger or user code from system.

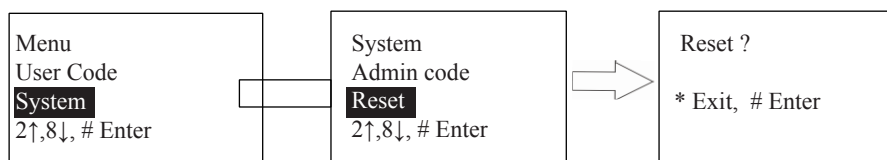

### 18. Audit Trail log

Login system, enter menu page (refer page 5 “5. Rule of operation”).  
You may check audit trail logs on lock directly. Touch “2” or “8” to page up or down

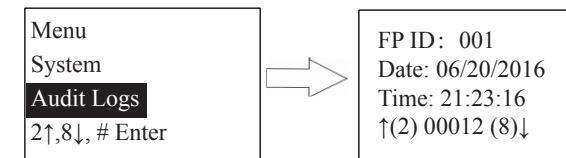

### 19. Passage mode enabling/disabling

The lock can be set at a passage mode. When the lock is in a passage mode, anybody could open the door by pushing down the lever.

To enable a passage mode, press \* within 5 second after any user unlocks the lock by using either a fingerprint or a user code. Any user unlocks the lock by using a fingerprint or a user code will disable a passage mode,

### 20. Key unlock

Insert a key in the cylinder to rotate 180° CLOCKWISE, then rotate lever to unlock. Rotate a key 180° COUNTER CLOCKWISE then take out the key to lock.

### 21. Low battery alert

Icon show battery level. Remind user to change battery when low battery.

### 22. Additional power

When power runs out, attach 9V battery to the ports that are located at the bottom of the lock to power up the system.

### 23. System reset

If you can't login the system, the system can be reset to the factory-set default mode by pressing the reset button. To reset the system, press the reset button and hold until you hear a long beep. The reset button is located on the PCB board. If you've already installed the lock onto a door, you will need to take the lock off the door in order to locate the reset button. After resetting the system, Programming Code will revert back to the default programming code (1234). All user fingerprints and user codes will remain in the system. You may login system to use command to delete all fingerprint or user code when you need it.

the lock onto a door, you will need to take the lock off the door in order to locate the reset button. After resetting the system, Programming Code will revert back to the default programming code (1234). All user fingerprints and user codes will remain in the system. You may login system to use command to delete all fingerprint or user code when you need it.

#### 24. Troubleshooting

	Beeps	Lights	Solution
Nothing happens when finger is placed on the fingerprint sensor.	None	None	Lift the finger then place the finger on top of the sensor.
Can't login by programming code.	Three	Red	Enter a valid Code. Reset system if you forgot.
Can't login by administrator fingerprint.	Three	Red	Login with a fingerprint ID as 0, 1, 2, 3, 4 or 5.
You hear three short beeps and see red light after enter user ID.	Three	Red	ID has been used. Try a different ID.
Can't program my fingerprint.	Three	Red	Try to program a different finger
Can't unlock by my fingerprint.	Three	Red	Try to place your finger on a different area or at a different angle.
Can't unlock by a User Code.	Three	Red	Try a different User Code.
System exits active status.	None	Red	Nothing to do.
Low power alert.	Multiple	Red	Change battery as soon as possible.
Can't rotate rear lever up or down.	None	None	Installation error, please refer to the installation instruction and re-install the lock.
System crash. The system doesn't accept any command.	None	None	Take one battery out, press any key for 2 seconds, and then place the battery back.
Battery hot or battery compartment melt	None	None	Remove battery immediately. Take off lock from door, check wire if it is pinched or
Front lever was pulled out	None	None	User must rotate key 180 degree; the lever may be pulled out if user rotates key 90 degree instead of 180 degree.
No power after placing battery in.	None	None	Check wire connection and check battery if it is put in

## Ardwolf A10 FINGERPRINT KEYPAD LOCK INSTALLATION INSTRUCTIONS

Tools needed for new installation:

Pencil, Chisel, Tape Measure, Hammer, Phillips Screwdriver, 1" (25 mm) & 1/8" (3 mm) Drill Bits, 2 1/8" (54 mm) Hole Boring Bit, Power Drill.

1. Mark door.

1.1 Mark centerline on door and jamb (see fig. 1).

1.2 Stand so door swings towards you.

2. Drill holes on door (see fig. 2, and 3), dimension 8 mm hole is optional.

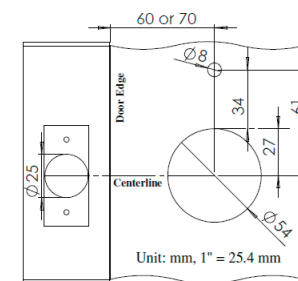
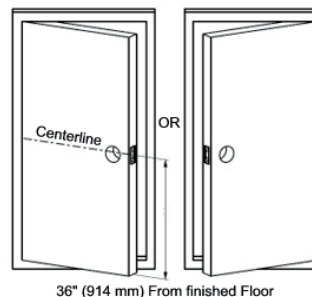

3. Install Latch.

3.1 Latch is adjustable, you may set the latch to either 2 3/8" (60 mm) or 2 3/4" (70 mm) backset (see fig.4).

3.2 Use faceplate as a pattern for mortise and pilot holes. The faceplate should fit flush (see fig. 5).

3.3 Install as shown for appropriate latch type. Ensure bevel faces doorjamb.

3.4 Check square hole edge on the latch spindle. The square hole edges MUST be either parallel or vertically aligned with latch centerline (see fig. 6), otherwise refer fig. 7 to adjust latch spindle.

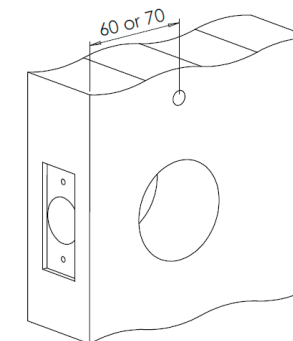



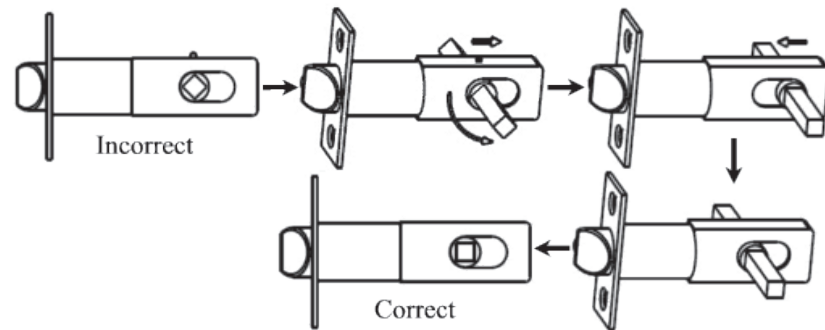
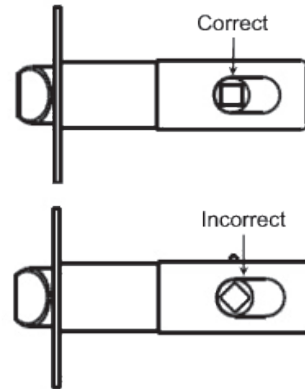
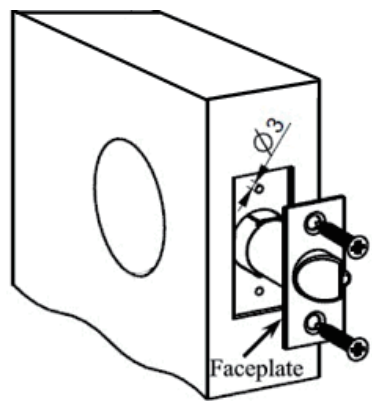
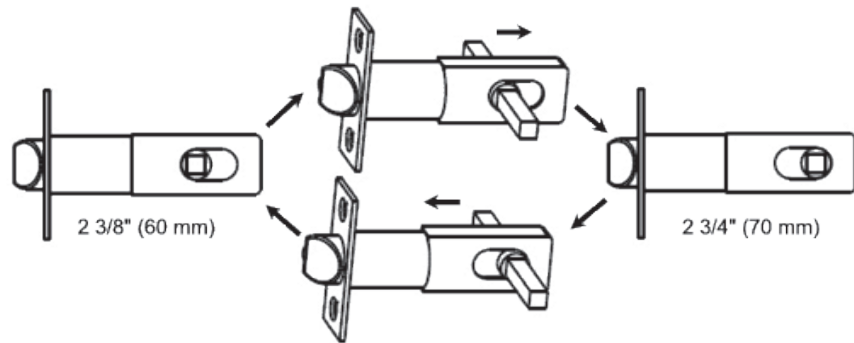

4. Prepare doorjamb (see fig. 8).

4.1 Mark centerlines on jamb exactly opposite center of latch hole.

4.2 Make rectangle holes as shown.

4.3 Use strike as a pattern for mortise and pilot holes. Strike should fit flush.

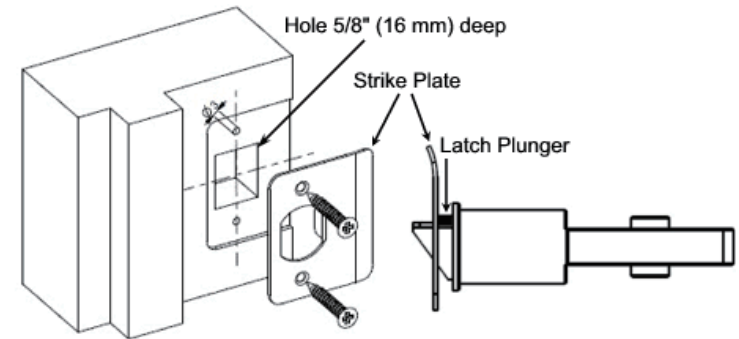

## Part II. Fingerprint Keypad Lock Installation Instructions

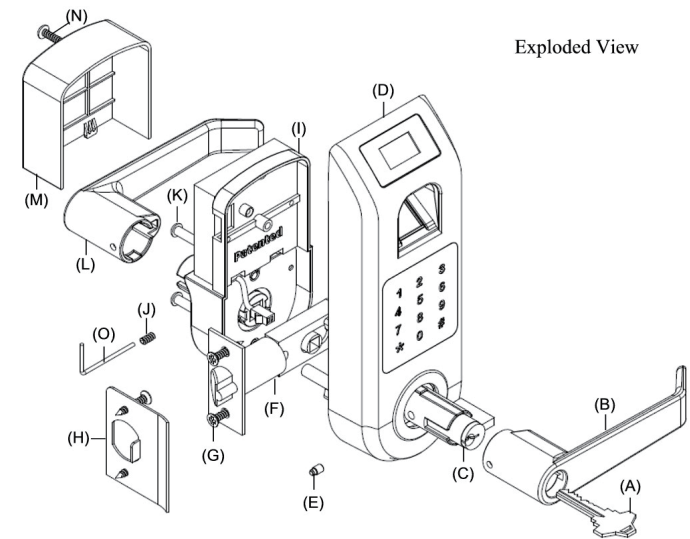

- |                     |                         |                     |
|---------------------|-------------------------|---------------------|
| (A) Key             | (F) Latch               | (A) Mounting Screws |
| (B) Outside Lever   | (G) Latch/Strike Screws | (B) Inside Lever    |
| (C) Cylinder        | (H) Strike              | (M) Cover           |
| (D) Outside chassis | (I) Inside chassis      | (N) Cover Screw     |
| (E) Lever Catch     | (J) Allen Screw         | (O) Allen Wrench    |

The lock comes with two (K) Mounting Screws M5x60 2 $\frac{3}{8}$ " (60 mm) long, one (N) M3x25 1" (25 mm) long Cover Screw, one (J) Allen Screw, one (E) Lever Catch and 4 pieces (G) Latch/Strike Screws.

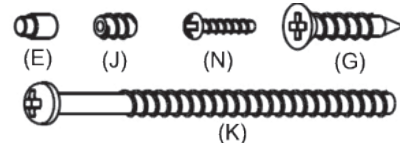

**Note:** The lock fit door thickness between 1 $\frac{3}{8}$ " and 2 $\frac{3}{8}$ ".

Contact manufacturer to order M5x50 2" (50 mm) long screw if your door thickness is less than 1 $\frac{3}{8}$ ".

Tools needed: Phillips Screwdriver, Tape Measure, Pencil, and Flathead Screwdriver.

#### IMPORTANT NOTES:

- **DO NOT use a power drill for installation!**

- Install and test lock with door open to avoid being locked out.

1. Install lock on the door.

1.1 The dent should be on 12-clock position (see fig. 1), if not, rotate Square Spindle to let the dent be on 12-clock position.

1.2 Install the outside chassis unit (see fig. 2). Slide wire through hole on door. Slide square spindle and poles smoothly through holes in latch. Take care to keep outside chassis vertically aligned during installation. Check latch setting and door dimensions if there is any problem.

1.3 Take care to keep inside chassis vertically aligned during installation. Connect wire and arrange wire in empty space, take care to ensure wire is not pinched or crushed at any point during installation. The Square Spindle slide smoothly into square hole on Lever Spindle (see fig. 3).

1.4 Insert Mounting Screws to mounting hole on the inside chassis (see fig. 4), screws should slide smoothly through hole on door.

Use Philip Driver to drive two screws into mounting hole on mounting poles.

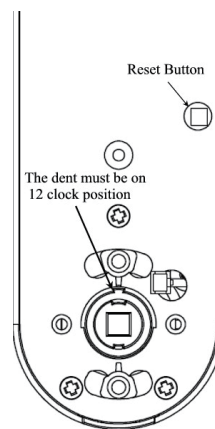

fig. 1

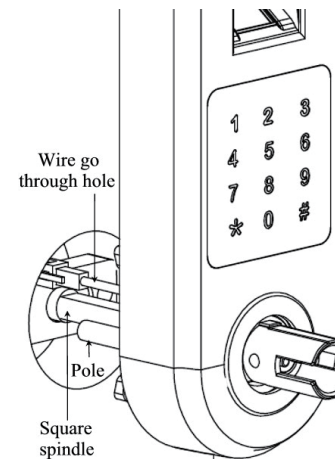

fig. 2

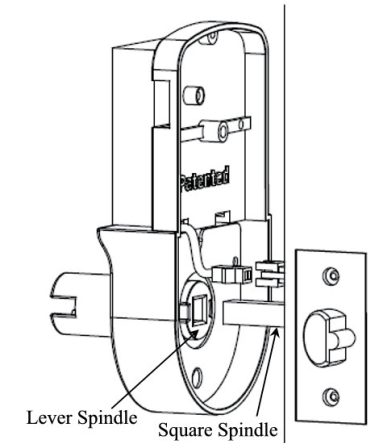

fig. 3

2. Set up inside Lever: Put Lever on Lever Spindle then use Allen Wrench to put Allen Screw (see fig. 5). Use Allen Wrench to take Allen Screw off then pull out Lever when you want to remove Lever.

3. Set up outside Lever: You may set up lever to fit for either left-handed or right-handed door.

3.1 Make sure that the dent is on 12-clock position when lock hasn't be installed on the door (see fig. 1), if not, rotate Square Spindle.

3.2 Rotate inner Spindle by Flathead Screwdriver let Cylindrical Protrusions horizontally aligned (see fig. 6).

3.3 Insert Lever Catch in the right side hole on Lever Spindle completely if your door is left-handed (see fig. 7a), otherwise put it in the left side hole (see fig. 8a). The big end on the Lever Catch goes into the hole first.

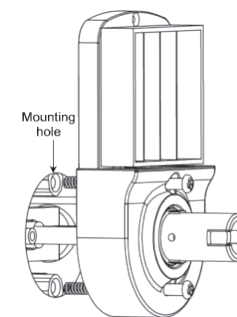

fig. 4

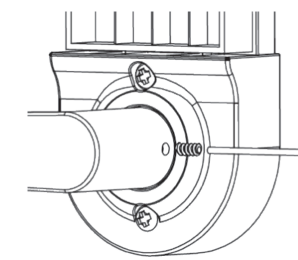

fig. 5

3.4 Insert Cylinder in Lever Spindle. The Cylinder's tail toward left if you want to set lock as left-handed (see fig. 7b), otherwise the Cylinder's tail toward right (see fig. 8b).

3.5 Put lever on Lever Spindle (see fig. 7c, 8c). The lever will stop at half way when you push Lever in. Insert key into Cylinder, push the lever (see fig. 9b) and rotate the key CLOCKWISE until the lever is pushed in. Key should be rotated around 90° but could be up to 135° (see fig. 9a). Rotate the key counter CLOCKWISE (see fig. 9c) then take the key out (see fig. 9d).

3.6 Remove Lever (if necessary): Insert key into Cylinder then rotate key CLOCKWISE 90°, use Allen Wrench or paper clip to push Lever Catch in then pull lever out (see fig. 10). Rotate key COUNTER CLOCKWISE 90° then take key out. Use Flathead Screwdriver to rotate Cylindrical Protrusions, the Lever Catch will protrude. Take the Lever Catch out, keep it in safe place.

3.7 Switching Levers (if necessary): Levers can be reversed to extend toward hinges. Refer 3.6 to remove lever then following 3.1 to 3.5 to set up lever.

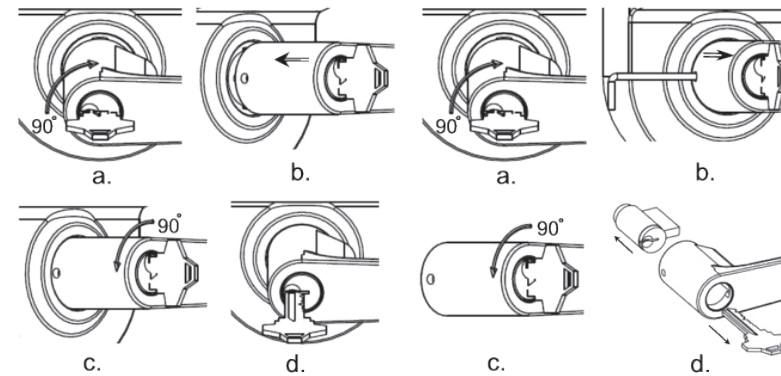
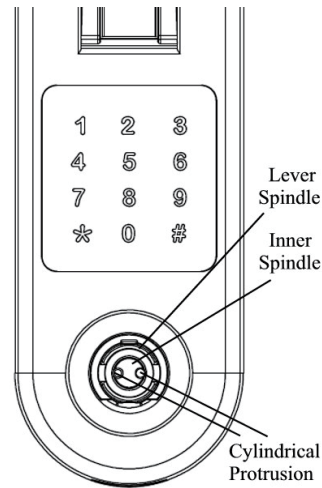

fig. 9

fig. 10

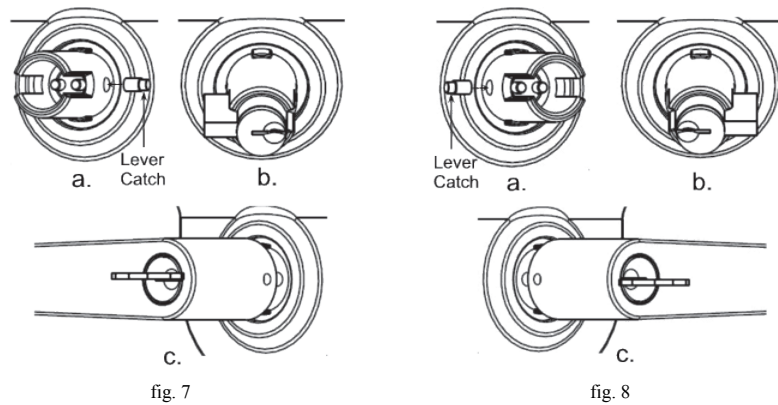

fig. 7

fig. 8

4. Install 4 brand new AA Alkaline batteries (NOT included, do not use rechargeable batteries). Alkaline Batteries Warning: Do not install backwards, charge, put in fire, or mix with other battery types, may explode or leak causing injury. Replace all batteries at the same time.

5. Slide cover down then tight cover screw (see figure 11).

6. Testing lock: Rear lever should be pushed down and lifted up. The lock may keep unlock after installation. Enter default code 1234 then press #. The lock will lock by itself after 5 second, otherwise check latch if it is broken.

7. Caution: User MUST install strike plate included in package.

The existing strike must be removed if there is one on doorjamb. Check the operation of the latch by ensuring that the latch plunger stops against the strike plate and does not slide into the strike opening when the door is closed (see fig. 12). If that situation occurs, then a total lockout may occur. This situation will void our warranty of the complete lock mechanism. If necessary, correct the door over-travel by using the rubber bumper (see fig. 13). You may buy the rubber bumpers from your local hardware store.

8. Lock removal: Reverse step 5, 4 and 2. Refer step 3.6 to remove outside Lever.

Reverse step 1.4 and 1.3 to remove outside chassis and inside chassis from the door.

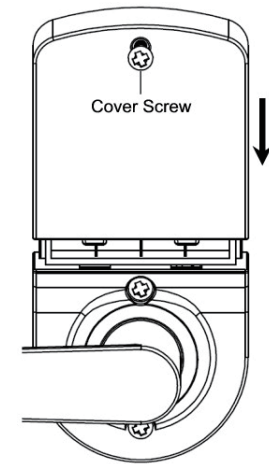

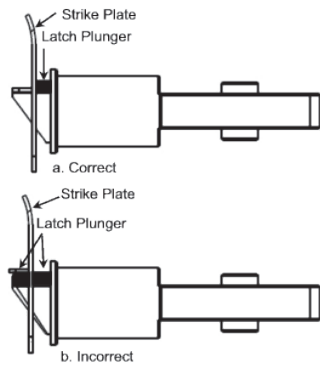

fig. 12

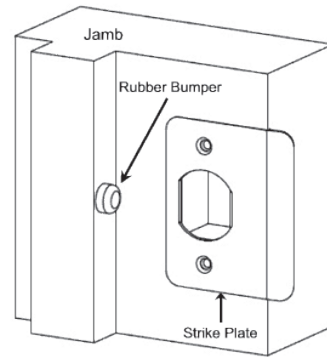
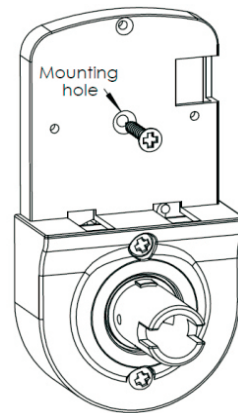

fig. 13

**Installation Option:**

The lock will stay on vertical position on the door as long as the two mounting screws were tied up in most case. You may put a tapping screw on inside chassis to increase lock stability.

1. Remove two screws in battery compartment. You will see mounting hole under battery compartment.
2. Use 3/8" (8 mm) Drill Bits to drill a hole on door through mounting hole.
3. Put screw pole on front metal plate.
4. Put screw through mounting hole to connect with screw pole.
5. Put battery compartment back.



**Product return:**

Please refer installation instruction to remove lock from door, remove levers from lock, and then refer the following diagram to pack lock.

