



Thank you for selecting JELD-WEN® products. Attached are JELD-WEN's recommended installation instructions for Exterior Wood, Steel and Fiberglass Pre-Hung Doors. Read these instructions thoroughly before beginning. They are designed to work in most existing applications; however, existing conditions may require changes to these instructions. If changes are needed, they are made at the installer's risk. For installations other than indicated in these instructions, contact a building professional. Areas such as Florida and the Texas TDI region have different anchoring requirements based on product certification. For information on specific products, visit [www.floridabuilding.org](http://www.floridabuilding.org) or [www.tdi.texas.gov](http://www.tdi.texas.gov) and follow the anchoring schedule given in the drawings for the product instead of the anchoring schedule in this document.

Newer construction methods have led to an increase in air and water tightness in buildings. This frequently leads to negative air pressure inside the house, which can draw water through very small openings. Our installation method seals the door to the weather barrier (typically building wrap) and uses a sill pan to capture and drain incidental storm water from under the door.

### IMPORTANT INFORMATION AND GLOSSARY

Not all exterior door types may be installed into every wall condition in all areas. See our [Appropriate Protection](#) document for overhang requirements and our [Additional Requirements](#) document for Fire Doors at [www.jeld-wen.com/resources](http://www.jeld-wen.com/resources). Consult your local building code official (or Authority having Jurisdiction) for applicable building codes and regulations. Local building code requirements supersede recommended installation instructions.

**Please Note!** Any exterior door installation where the sill is higher than 35 feet above ground level or into a wall condition not specifically addressed in these instructions must be designed by an architect or structural engineer. Failure to install square, level and plumb and on a flat surface (without twist or warp) could result in denial of warranty claims for operational or performance problems.

**Note to Installer:** Provide a copy of these instructions to the building owner. By installing this product, you acknowledge the terms and conditions of the limited warranty as part of the terms of the sale.

#### GLOSSARY

##### Backer Rod (backing material)

A material (e.g. foam rod), placed into a joint primarily to control the depth of the sealant.

##### Buck

A wood framework attached to the masonry inside a window or a door rough opening.

##### Door System/Pre-Hung Door

A pre-cut and assembled unit consisting of a door slab (prepared for the locking or passage hardware) hung on hinges in a wood or metal frame.

##### Hinge Jamb

The side of the jamb on which the hinges of a door are installed.

##### Rough Opening

The framed opening in a wall where a door is to be installed.

##### Security Plate

A metal plate pre-installed into the frame of a pre-hung door. It is designed to provide extra strength and stability from a forced entry attempt by allowing the latch of the door to rest inside it when the door is closed.

##### Shiplap

The layering method in which each layer overlaps the layer below it so that water runs down the outside.

##### Shipping Strap

Small, metal or plastic clips that come attached to a door system. These clips help keep a door slab closed and aligned before and during installation.

##### Sidelight

A fixed, usually rectangular window placed on either side of a door.

##### Sill Pan

A flashing component installed in the sill of the rough opening underneath the door. Sill pans have upturned walls along the interior edge and at both ends, creating a three-sided box. This component serves as a collection device to drain incidental water to the exterior of the building and should be properly sealed to the opening. The best sill pan design has a positive slope to the exterior and offers continuous support to the door's sill.

##### Strike Jamb

The side of the jamb that makes contact with the latch on a door slab.

Please allow sufficient time to properly prepare the rough opening, install the entry door, and ensure its proper operation.

Estimated Install Time for New Construction	<input type="checkbox"/> First Time: 4.0 hr.	
	<input type="checkbox"/> Experienced: 2.5 hr.	
	<input type="checkbox"/> Professional: 1.5 hr.	

#### LANDINGS

These instructions cover two sill conditions: the **step-down landing** and the **continuous slab landing**. The installation methods vary slightly between landing types.

##### Step-Down Landing

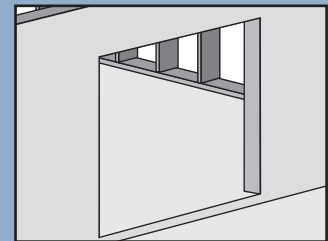

##### Continuous Slab Landing

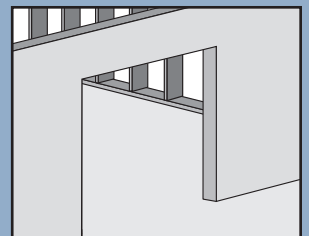

## ROUGH OPENINGS

This installation guide specifically addresses masonry/block wall, sheathed wall and open-stud construction.

### MASONRY/BLOCK WALL CONSTRUCTION

This installation assumes that a building professional has already fastened and sealed a framework of studs (often called a buck) to the concrete/masonry wall.

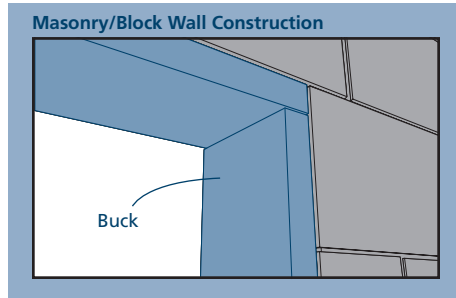

### FULLY SHEATHED WALL CONSTRUCTION

The wall framing is covered by sheathing and the door will be mounted with the exterior trim flush against the sheathing. This installation assumes building wrap is properly installed prior to installation.

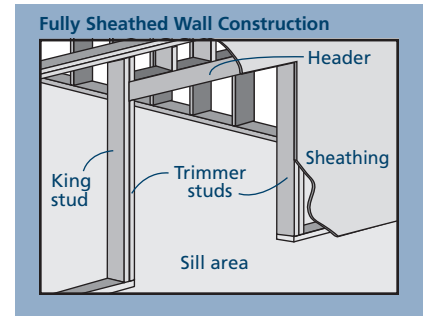

### OPEN-STUD CONSTRUCTION

The wall framing needs to be completely surrounded by backing support (non-water degradable, thin (max. 1/8" thick) sheet material such as plywood or lauan) before installing building wrap and the door. The door will be mounted with the exterior trim flush against the applied backing support.

## SAFETY AND HANDLING

### SAFETY

- Read and fully understand ALL manufacturer's instructions before beginning. Failure to follow proper installation instructions may result in the denial of warranty claims for operational or performance problems.
- Do not work alone. Two or more people are required. Use safe lifting techniques.
- Use caution when handling glass. Broken or cracked glass can cause serious injury.
- Wear protective gear (e.g. safety glasses, gloves, ear protection, etc.).
- Operate hand/power tools safely and follow manufacturer's operating instructions.
- Use caution when working at elevated heights.
- If disturbing existing paint, take proper precautions if lead paint is suspected (commonly used before 1979). Your regional EPA ([www.epa.gov/lead](http://www.epa.gov/lead)) or Consumer Product Safety Commission offices provide information regarding regulations and lead protection.

- **WARNING:** Drilling, sawing, sanding or machining wood products generates wood dust, a substance known to the State of California to cause cancer. Use a respirator or other safeguards to avoid inhaling wood dust.

### MATERIALS AND DOOR HANDLING

- Make sure the operating panel is secured prior to installation.
- Heed material manufacturer's handling and application instructions.
- Protect adhesive surfaces from dirt, moisture, direct sunlight and folding over onto themselves.
- Handle in vertical position; do not drag on floor.
- Do not put stress on joints, corners or frames.
- Store door in dry, well-ventilated area in vertical, leaning position to allow air circulation; do not stack horizontally.
- Protect from exposure to direct sunlight during storage.
- Install only into vertical walls and when conditions and sheathing are dry.

**IF INJURY OCCURS, IMMEDIATELY SEEK MEDICAL ATTENTION!**

## MATERIALS AND TOOLS

### PROVIDED MATERIALS

- 2 - #9 x 2½" screws.
- Foam weatherstrip wedges (corner seal pads).

### NEEDED MATERIALS

**Note!** JELD-WEN exterior window and door products should be installed in accordance with JELD-WEN's recommended installation and flashing directions, which are shipped with the products or can be found on our website: [www.jeld-wen.com](http://www.jeld-wen.com). Note that alternative installation methods and flashing systems may be utilized at the installer's or owner's discretion and, in such situations the installation should be done in accordance with the flashing manufacturer's instructions. Follow all material manufacturer's instructions for proper use and compatibility. When using flashing, spray adhesive/primer, sealant and foam products, we recommend using the same manufacturer and verifying compatibility. It is the End User's responsibility to determine if dissimilar materials are compatible to the substrates in the application.

- Lockset
- 10d galvanized casing nails (if plan to stain) or #8 x 3" deck screws (if plan to paint).
- Non-compressible or non-water degradable shims.
- Sill pan: It is best practice to use a pre-formed, rigid, positively sloped, pvc pan that provides continuous support. We recommend using SureSill™ Sloped Sill Pan™, manufactured by SureSill™, Ltd. An alternative would be a non-sloped pre-formed sill pan or one that can be fabricated on site from metal or vinyl sheet material with the proper tools.
- Backer rod 1/8" larger than the widest portion of the gap (used in conjunction with sealant bead).
- Sealant: We recommend OSI® QUAD® Max Sealant or equivalent. This can be used in any application and can be painted or ordered in a color matched product, if desired.
- Polyurethane low expansion Window and Door foam: We recommend OSI® QUAD® Foam or equivalent).

**MATERIALS AND TOOLS - CONTINUED**

- Plastic drain screen with crisscross or woven pattern (sold in 6" widths to protect rain gutters) for step-down landings.
- 3/8" staples for step-down landings.
- Drip cap, if required because of door location and exposure. Doors with an adequate overhang (see our Appropriate Protection document at [www.jeld-wen.com/learn/resources/care-maintenance](http://www.jeld-wen.com/learn/resources/care-maintenance)) may not need a drip cap.

**For installations into a Buck:**

- Liquid applied flashing (Protecto Wrap LWM 200 or equivalent).

**For installations into a stud-framed wall:**

- 4", 6", or 9" (as required by local code and window configuration) wide self-adhered flashing: We recommend OSI® QUAD® Butyl Flashing Tape or equivalent.

**NEEDED TOOLS**

- |                                     |                        |                         |
|-------------------------------------|------------------------|-------------------------|
| • Cutting shears (sill pan)         | • J-roller             | • Nail set              |
| • Tape measure                      | • Caulking gun         | • Square                |
| • Utility knife                     | • Drill with bits      | • Pencil                |
| • Level (4 ft. minimum recommended) | • Construction stapler | • Pry bar               |
|                                     | • Hammer               | • Small punch or magnet |
|                                     | • Screwdrivers         |                         |

**1**

**REMOVE PACKAGING AND INSPECT DOOR**

**REMOVE PACKAGING**

Remove shipping materials such as corner covers, shipping blocks or pads. Remove any staples exposed on the frame, but leave glass protective films.

1. If the door unit includes packaging or a skidboard under the threshold and bottom end of the side jamb, remove it. If the door comes with a security plate on the outside of the frame at the strike, DO NOT remove it. Install the door with the security plate attached.
2. If the door is fastened closed with a duplex nail or removable plastic plug, remove these along with the packaging and crating.

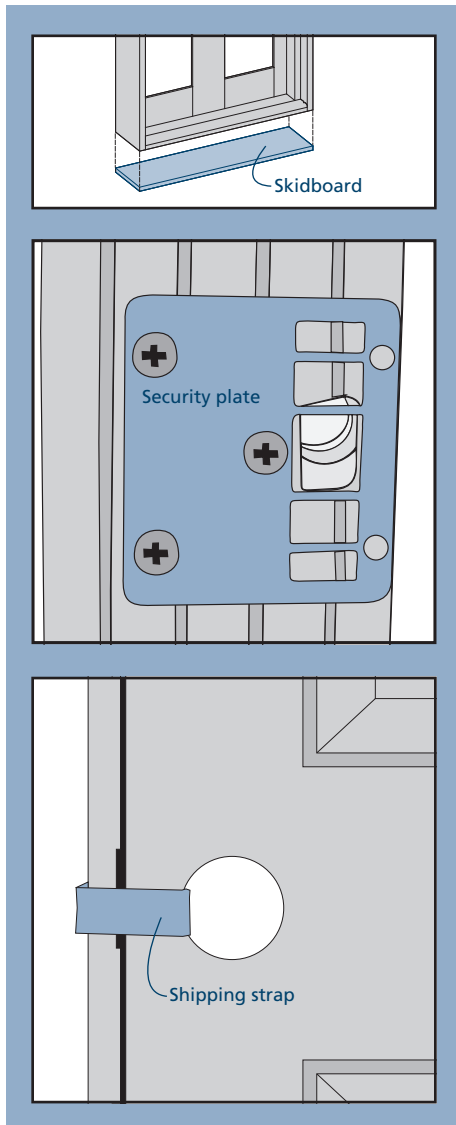

**Note!** If the door has shipping straps, DO NOT remove them until instructed to do so. These hold the door system aligned and closed during installation.

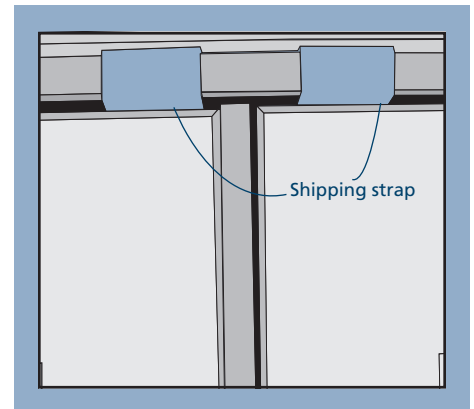

**INSPECT DOOR**

- Cosmetic damage.
- Product squareness (diagonal measurements must be within 1/4" difference).
- Correct product (size, color, grid pattern, handing (side the hinges are on), glazing, energy-efficiency requirements, etc.).

If any of the above conditions represent a concern, or if you expect environmental conditions to exceed the door's performance rating, do not install the door. Contact your dealer or distributor for recommendations.

**2**

**INSPECT ROUGH OPENING**

- Determine prior to installation what the actual finish floor height will be and adjust the rough opening if needed to accommodate a taller unit height. Most doors use a 1 $\frac{3}{8}$ " high threshold which provides adequate clearance in most applications. This ensures that the door does not drag on interior floors after installation.
- Verify the door is 1" narrower and 3/4" shorter (1/2" each smaller if code requires) than the rough opening width/height. 90-minute fire doors should be 1/4" narrower and 5/8" shorter.

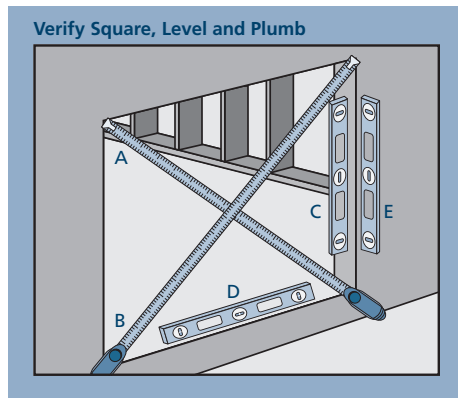

- Verify the rough opening is square. The (A) and (B) measurements should be the same. Maximum allowable deviation from square is 1/4".
- Verify the rough opening is plumb (C, E and D). The maximum allowable deviation is 1/8".
- The rough opening sill must not be crowned or sagged (D), but rather be level or sloped (positive slope) to the exterior.
- The exterior face of the rough opening must be in a single plane (E) with less than 1/8" twist from corner to corner.
- Minimum double studs should be used at all wood framed rough openings.
- The header must be supported by trimmer studs.

**FOR RETROFIT INSTALLATIONS**

After removing the old door, remove sufficient cladding (siding, stucco, etc.) to expose enough intact building wrap to properly seal the door system to the opening. If damaged, apply new building wrap in shi lap manner. Verify the rough opening framing is structurally sound. Contact your local waste management entities for proper disposal or recycling of products being removed.

**3**

**INSTALL SILL PAN**

The sill can be prepared using one of two methods: We recommend SureSill™ Sloped Sill Pan™ available from SureSill at [www.suresill.com](http://www.suresill.com), building supply stores, and some manufacturing locations. As an alternative, a sill pan can be fabricated on site, by following the instructions below. If installing a SureSill™ sill pan, follow SureSill's instructions for installation and skip to section 5 "PREPARE STUD-FRAMED WALL".

**JOBSITE FABRICATED SILL PAN**

1. Cut a piece of sheet material to the length shown.
2. Lightly crease folding lines 1/2" in from the two short sides and one long side.
3. Measure the distance from the back of the trim to the interior edge of the frame and add 9/16".
4. Take this distance from the back edge and lightly crease a folding line across the sheet material.
5. For step-down landings, cut 1/2" in at this line on both sides of the sheet material.

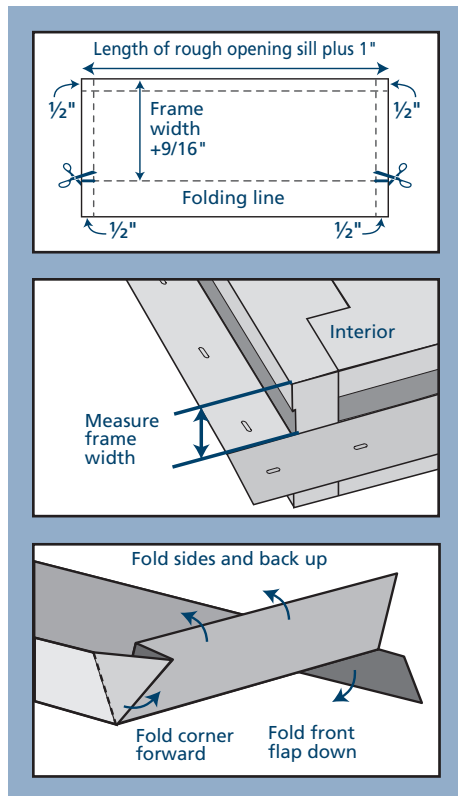

6. For continuous slab, cut across the folding line.
7. Fold the three back sides up to make a 3-sided box, and, for step-down landings, fold the front flap down.

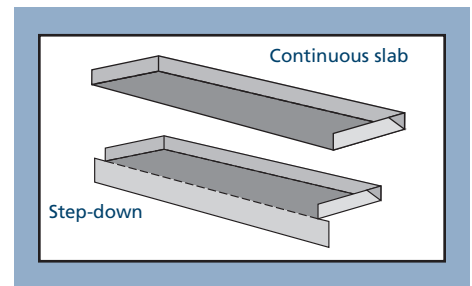

**INSTALL SILL PAN**

1. Set the sill pan in the rough opening, aligning the front edge (for continuous slab) or folded down edge (for step-down) with the exterior of the rough opening.
2. Mark a line across the front and back of the sill pan.
3. Apply three 3/8" beads of sealant between the lines.
4. Place the sill pan in the rough opening. Firmly press the sill pan into the sealant with a J-roller.

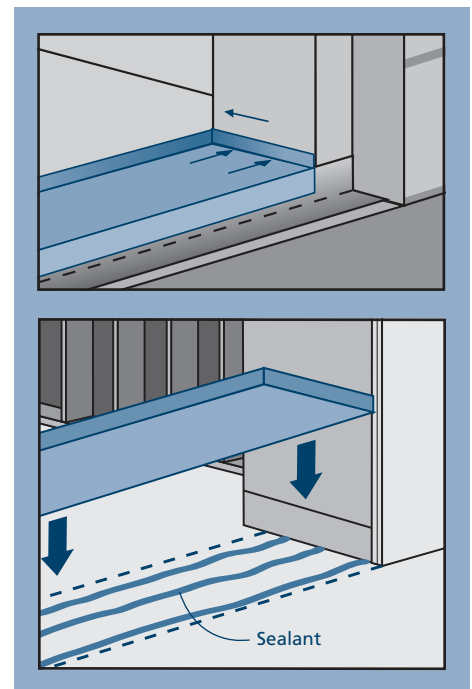

**4**

**PREPARE BUCK**

**Note!** This section applies to installations into a buck only. For installations into a stud-framed wall, begin with section 5, "PREPARE STUD-FRAMED WALL."

1. Seal any joint larger than 1/16" in the buck and between the buck and the concrete/masonry with sealant.
2. Cover the buck and the surrounding concrete/masonry at the head and jambs and sill with liquid applied flashing as shown.

**END of Buck Instructions, SKIP to section 6, "INSTALL DOOR."**

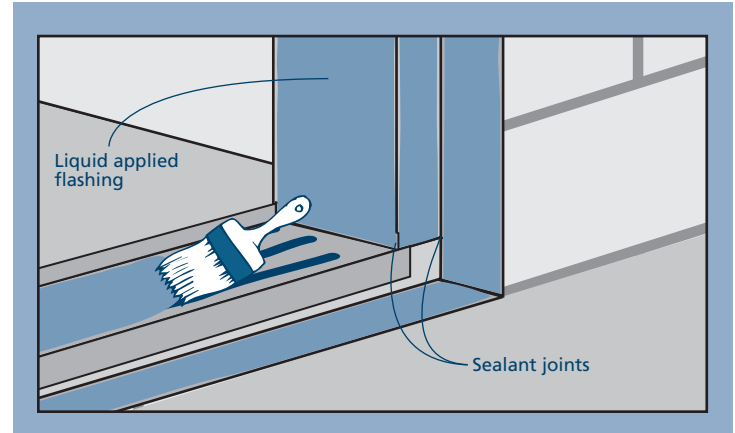

**5**

**PREPARE STUD-FRAMED WALL**

**FOR RETROFIT INSTALLATIONS**

After removing the old door, remove sufficient siding to expose at least 9" of intact building wrap. If damaged, apply new building wrap in a shiplap manner. Verify header and trimmer studs are structurally sound.

**PREPARE BUILDING WRAP**

Verify these steps are allowed by the building wrap manufacturer.

1. Trim building wrap flush with the edges of the rough opening.
2. If installing a drip cap, (recommended because this integrates the building wrap and drip cap to protect the structure and the product from incidental water) at the head, slit building wrap 6" at 45°. Tape up as shown.
3. Trim the sides sufficiently to allow the nailing fin to be mounted against the sheathing.
4. Apply spray adhesive/ primer to the sill pan and surrounding area. Follow manufacturer's instructions for application methods.
5. Cut a piece of self-adhered flashing the length of the sill and apply over the sill pan as shown. The bottom of the sill pan should be completely covered by the self-adhered flashing. For step-down landings, fold flashing down as shown. For continuous slabs, trim flush with rough opening.

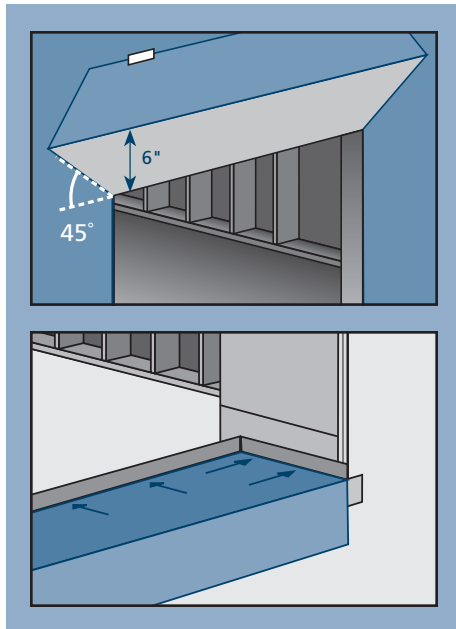

6. Cut two pieces of self-adhered flashing 6" wide by the sill pan width + 3" long.

- a. For continuous slab landings only, cut out the inside corner.
- b. Adhere the pieces of flashing to the inside corners. Stretch flashing as needed to cover corners and lay flat.

7. Smooth gaps or bubbles beneath self-adhered flashing with a J-roller (remove and replace if necessary).
8. Seal back corners of sill pan with sealant.
9. For step-down landings only, cut plastic drain screen to length of sill + 2" and staple 1/2" below sill edge. The drain screen provides a path for air to dry any incidental moisture in the rough opening.

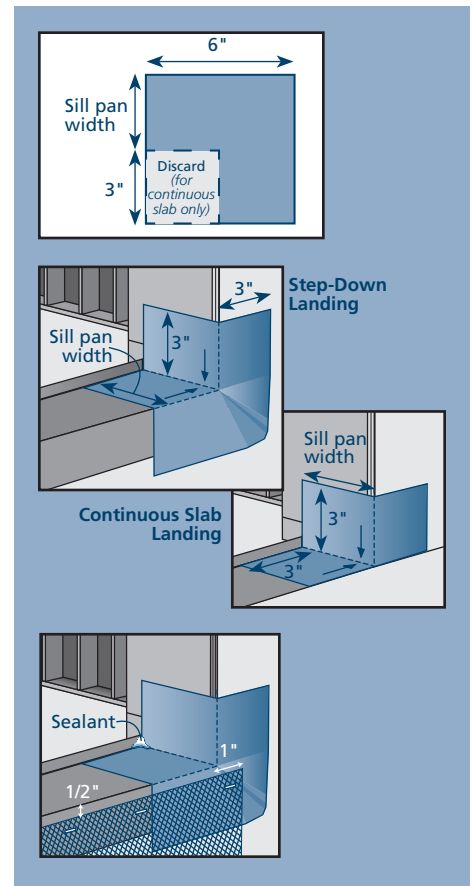

**END of Stud-Framed Wall Instructions, continue with section 6, "INSTALL DOOR."**

**6** INSTALL DOOR

**Warning!** To avoid injury, use at least two people to install. Adequately support the door until fully installed.

**PREPARE DOOR**

1. On the interior side, apply a continuous bead of silicone sealant where the exterior trim meets the door frame as shown. Tool into a fillet shape.
2. Apply a 3/8" continuous bead of sealant across the sill pan back dam and over the flashing joints as shown.

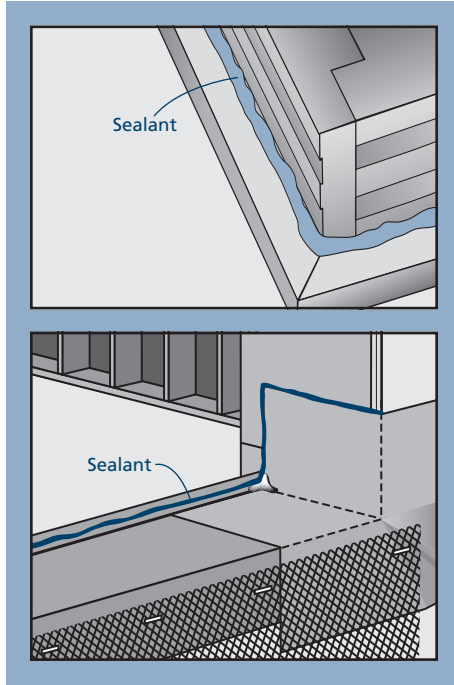

**INSTALL DOOR**

**WARNING!** If installing fasteners through fiberglass components, we recommend pre-drilling holes to keep the fiberglass from splitting.

**Note!** This section covers single door, double door, and doors with a transom or a sidelight(s) already installed by the factory.

1. Remove any pre-hanging clips that are fastened to the outside of the jamb that will be covered when the unit is placed in the rough opening. Adequately support the slab to keep it from swinging open during installation.
2. For units with brickmould trim, apply a 3/8" bead of sealant to the back of the trim where it will contact the structure. From the outside, tilt the entire pre-hung door into the center of the opening. Make sure the sill contacts the sealant on the sill pan back dam (upturned leg on the interior).

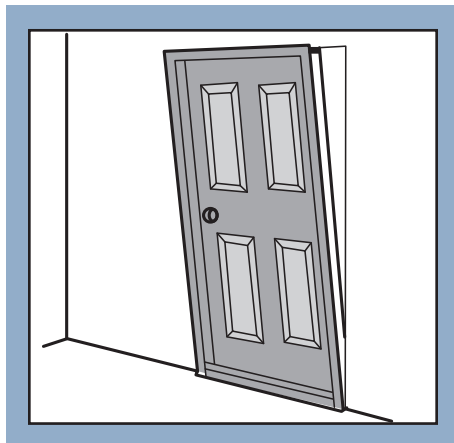

3. Temporarily fasten the door as follows. For metal frames, drive a nail or screw through one lower hole in the flange. For doors without a sidelight(s), secure the hinge jamb by placing one 10d casing nail (or one #8 x 3" deck screw) horizontally centered in the hinge jamb or brickmould trim 20" from the top and bottom (or just above the lower hinge) of the door. Do not set nails/screws. For appearance reasons, fasteners can be driven behind (but not through) the weatherstrip if desired. Secure sidelight(s) in a similar manner through the frame and into the wall.

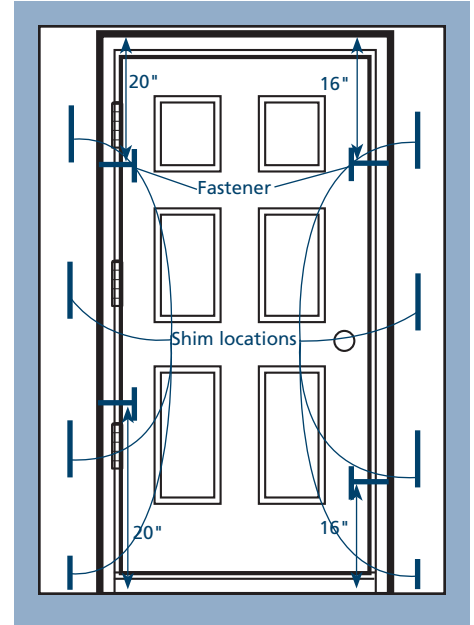

4. From the inside, shim the jambs as follows: One shim on each end of the sill (between jamb and sill, not under sill). Single/double units at each hinge location and at the strike plate. Units with sidelights, between the sidelight and wall in at least 3 places until the door is square in the opening.
5. For doors with metal frames, secure with nails or screws through the provided holes in the frame either above or below every oval slot. For all other doors, temporarily fasten the latch jamb by placing one 10d casing nail (or one #8 x 3" deck screw) horizontally centered in the latch jamb 16" from the top and bottom of the door. Do not set nails/screws.
6. Verify the door unit is square, then securely fasten the hinge jamb by setting the two nails or screws installed earlier. Add an additional nail or screw centered between the first two and one 4" from each corner.
7. Remove any remaining pre-hanging clips. Be sure the door opens freely and that the space between the door and the jamb is even on all sides. Adjust if necessary by loosening or removing the strike jamb fasteners and adjust until there is even contact between the slab and weatherstrip. Secure all fasteners.

**DOUBLE DOOR, SIDELIGHT OR TRANSOM INSTALLATIONS**

1. If installing a door with a sidelight(s), shim the head on both sides of the joint where the sidelight joins the door jamb. Fasten next to the shims and then remove shims.
2. Shim the head of double door units or units with sidelight(s) at the center of each slab/sidelight. Fasten next to the shims and then remove shims. Fasten a transom in a similar manner every 16".

**6** INSTALL DOOR - CONTINUED

- From the inside of doors with sidelights installed on a wood floor, pre-drill for #8 screws and fill the holes with sealant. Drive two #8 x 3" deck screws through each door jamb and sidelight into the floor in the locations shown.
- Some double door units may require installing lock bolts at the top and bottom of the inactive panel. Follow the instructions that come with the product if available. Otherwise, locate the center point of each lock bolt, drill 3/8" bolt holes and install keeper plates.

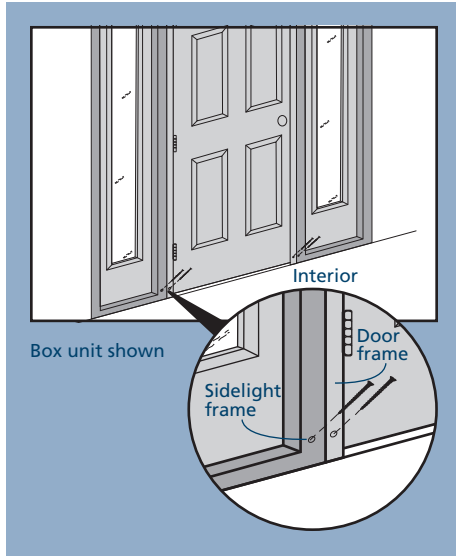

- If installing a door with a metal frame and adjustable T-Strike, place A over B and place in the bore in the frame. Install screws but do not tighten. Close door and push B inward until the door slightly compresses the weatherstrip. Open door and tighten screws.
- At the sill, pull the weatherstrip up slightly and apply a bead of sealant (behind the weatherstrip) at the intersection of the jambs, brickmoulds, thresholds and floor as shown. The included foam wedges are used to complete the weatherstrip seal at each bottom corner between the jamb and operating slab(s) when closed. Position the thick edge behind the weatherstrip, remove the backing paper and adhere to the jamb as shown.

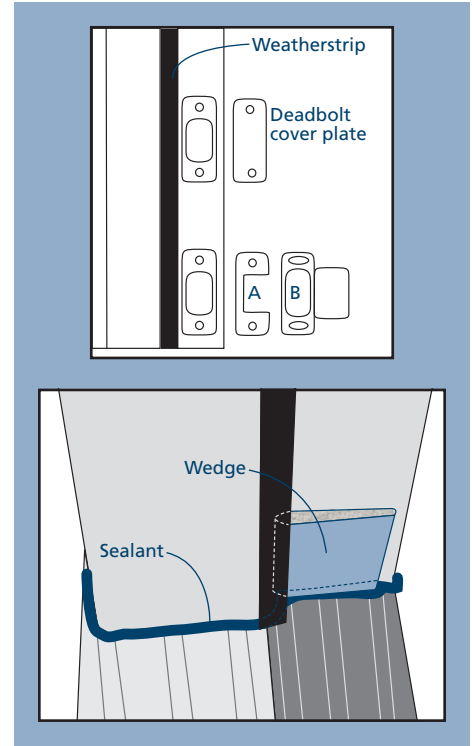

**FINISH INSTALLATION**

- Re-check for smooth door operation and even spacing between the door and jamb. Secure the strike jamb evenly between the first two already in place with two more 10d casing nails (or #8 x 3" deck screws) behind the weatherstrip.

**Note!** Steps 2 and 3 apply only to units with hinge jamb(s) against the rough opening.

- Install two provided #9 x 2 1/2" wood screws in the top hinge through the two holes closest to the weatherstrip, driving them through the hinge jamb and into the studs. If necessary, remove the screws already in the hinges to insert these longer screws.
- If installing a door with a metal frame, on the exterior, slide the "L" shaped head piece into the inner section and center it in the opening. Install the jamb pieces making sure they are tight against the head piece and rough opening. Secure with fasteners through the provided holes.

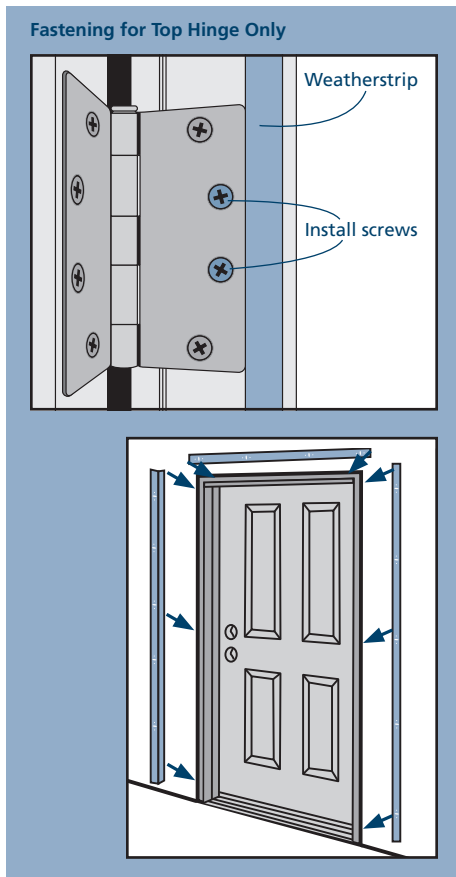

- Install drip cap if required or desired. Fold the building wrap (previously taped up) down over the drip cap and seal the cut ends with self-adhered flashing or building wrap tape.
- For metal frames, apply casing to both sides. Mark the locations of the oval slots in the frame onto the casing and secure casing with fasteners through the oval slots. For snap on steel casing, refer to the instructions with the clips.

- Apply sealant around the outside of the door unit between the siding and brickmould, between the brickmould and the jamb and between the jamb sides and the threshold. Apply a discontinuous bead of sealant (1/2" gap every 1') along the front side of the threshold.

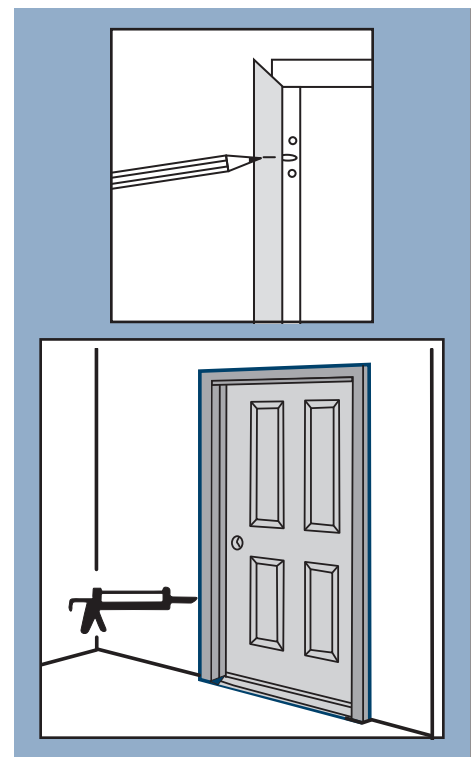

**6**

**INSTALL DOOR - CONTINUED**

**FINISH INSTALLATION - CONTINUED**

9. Create a continuous air seal on the interior between the rough opening and the door frame with low expansion foam.
10. Ensure sealant on back dam of the sill pan fully seals to the inside face of the sill. Apply more sealant as necessary.
11. On the exterior of step-down landings, install support trim underneath the sill where it extends past the landing. Position trim snugly against the bottom of the sill toe/nose.

**7**

**COMPLETE INSTALLATION**

1. If installing a fire door, verify the correct seal (weatherstrip) is installed in the frame and conforms to local codes.
2. Fill any nail/screw holes and sand smooth.
3. Finish all six sides of the door slab as well as the frame.
4. Install exterior wall surface within seven days of installation.
5. Install lockset hardware per supplied instructions.

**FIRE DOOR HINGES**

Do not remove or paint over any fire labels. Please see our separate document for additional requirements for installing fire-rated doors at [www.jeld-wen.com/resources](http://www.jeld-wen.com/resources). Automatically closing hinges are required on fire doors and when allowed to close by themselves from 18", should close and latch securely. If it does not, adjust the spring as follows:

1. With the door closed, insert the provided hex wrench so that it can be rotated clockwise. Hold in place and remove tension pin with a small punch or magnet.
2. Rotate hex wrench clockwise 1/4 turn and re-insert tension pin loosely into tension hole.
3. Remove hex wrench and try closing force.
4. Repeat steps until closing force is adequate but do not rotate past 3 holes on 180° openings or 4 holes on 90° openings.

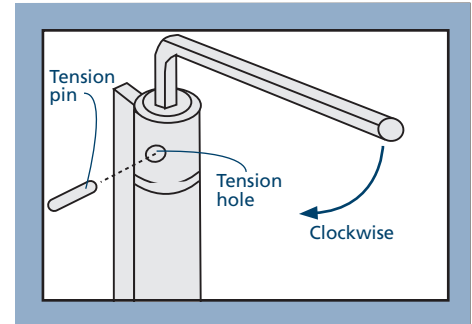

6. Remove protective film (if applicable) on glass after all construction is complete or within one year.
7. Protect recently installed units from damage from plaster, paint, etc. by covering the unit with plastic.
8. Install any interior trim as desired.
9. Sealant joints will need to be inspected at least once a year and repaired as necessary.

Please visit [jeld-wen.com](http://jeld-wen.com) for warranty and care and maintenance information.

Thank you for choosing

