



Specifications

Disposal Description

- GX PRO Series packs all the standard features and reliable performance in a more compact form
- 1/2 Horsepower VORTEX™ Motor has powerful grinding capabilities for everyday kitchen scraps
- VORTEX™ Motor features permanent magnet motor technology designed to help reduce jamming
- Universal Xpress Mount™ fits all Moen and most existing 3-bolt mounting assemblies
- Ultra compact design frees up space under the sink
- Continuous feed with galvanized steel grind components
- Manual Reset Button
- Garbage disposals reduce waste sent to landfills making it an eco-friendly option for your home

Included Components

- GXP50c Disposal Unit with Universal Xpress Mount™
- Pre-installed Power Cord
- Removable Splash Guard
- Polished Stainless Steel Sink Flange and Drain Stopper
- Drain Stopper and Polished Stainless Steel Sink Flange

Warranty & Assurance

- 3 year limited warranty with in-home service
- Safe for use with properly sized septic systems



Model: GXP50c



Critical Dimensions

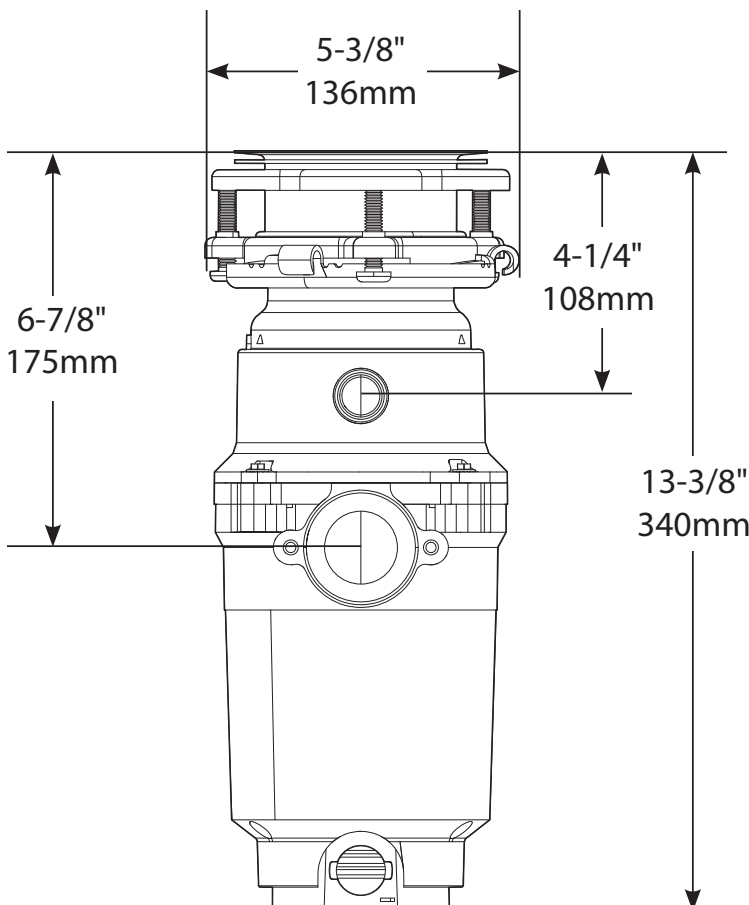

Specification Detail	
Horsepower	1/2 HP
Feed Type	Continuous
On/Off Controls	Wall Switch
Motor Type	Single Phase Permanent Magnet Motor
RPM (Revolutions Per Minute)	2600
Weight	9.25 lbs/ 4.2 kg
Volts	115
Hz/Amps	60/4.5
Drain Connection Size	1 1/2" / 38mm
Dishwasher Connection Size	7/8" / 22mm
Maximum Sink Thickness	1/2" / 13mm
Sink Drain Flange Finish	Polished Stainless Steel
Grind Component Material	Galvanized Steel
Grind Chamber Material	Corrosion Proof Glass Filled Polyester and Nylon