

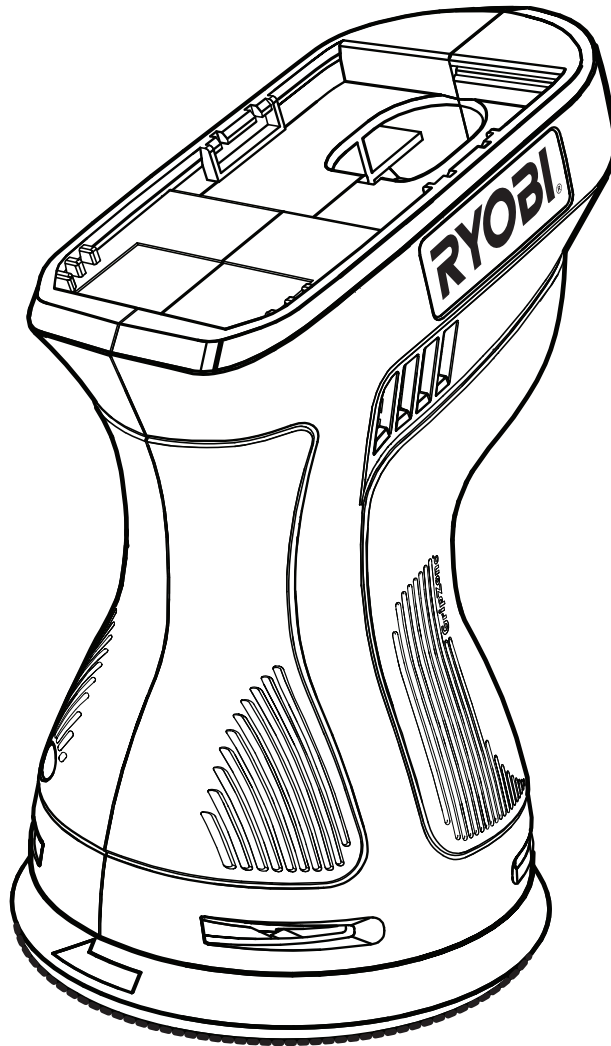

OPERATOR'S MANUAL

18 VOLT RANDOM ORBIT SANDER

P410



**BATTERIES AND CHARGERS
SOLD SEPARATELY**

Your sander has been engineered and manufactured to our high standard for dependability, ease of operation, and operator safety. When properly cared for, it will give you years of rugged, trouble-free performance.

⚠ WARNING: To reduce the risk of injury, the user must read and understand the operator's manual before using this product.

Thank you for your purchase.

SAVE THIS MANUAL FOR FUTURE REFERENCE

TABLE OF CONTENTS

■ Introduction	2
■ Warranty	2
■ General Safety Rules	3-4
■ Specific Safety Rules.....	4
■ Safety Rules for Charger	5
■ Symbols.....	6-7
■ Features.....	8-9
■ Assembly	9
■ Operation.....	10-13
■ Maintenance.....	14
■ Parts Ordering / Service	Backpage

INTRODUCTION

This product has many features for making its use more pleasant and enjoyable. Safety, performance, and dependability have been given top priority in the design of this product making it easy to maintain and operate.

WARRANTY

RYOBI® POWER TOOL - LIMITED TWO YEAR WARRANTY AND 30 DAY EXCHANGE POLICY

One World Technologies, Inc., warrants its RYOBI® power tools with the following conditions:

30-DAY EXCHANGE POLICY: During the first 30 days after date of purchase, you may either request service under this warranty or you may exchange any RYOBI® power tool which does not work properly due to defective workmanship or materials by returning the power tool to the dealer from which it was purchased. To receive a replacement power tool or requested warranty service, you must present proof of purchase and return all original equipment packaged with the original product. The replacement power tool will be covered by the limited warranty for the balance of the two year period from the date of the original purchase.

WHAT THIS WARRANTY COVERS: This warranty covers all defects in workmanship or materials in your RYOBI® power tool for a period of two years from the date of purchase. With the exception of batteries, power tool accessories are warranted for ninety (90) days. Batteries are warranted for two years.

HOW TO GET SERVICE: Just return the power tool, properly packaged and postage prepaid, to an Authorized Service Center. You can obtain the location of the Service Center nearest you by contacting a service representative at One World Technologies, Inc., P.O. Box 1207, Anderson, SC 29622-1207, by calling 1-800-525-2579 or by logging on to www.ryobitools.com. When you request warranty service, you must also present proof of purchase documentation, which includes the date of purchase (for example, a bill of sale). We will repair any faulty workmanship, and either repair or replace any defective part, at our option. We will do so without any charge to you. We will complete the work in a reasonable time, but, in any case, within ninety (90) days or less.

WHAT'S NOT COVERED: This warranty applies only to the original purchaser at retail and may not be transferred. This warranty only covers defects arising under normal usage and does not cover any malfunction, failure or defects resulting from misuse, abuse, neglect, alteration, modification or repairs by other than Authorized Service Centers. One World Technologies, Inc. makes no warranties, representations or promises as to the quality or performance of its power tools other than those specifically stated in this warranty.

ADDITIONAL LIMITATIONS: Any implied warranties granted under state law, including warranties of merchantability or fitness for a particular purpose, are limited to two years from the date of purchase. One World Technologies, Inc. is not responsible for direct, indirect, or incidental damages, so the above limitations and exclusions may not apply to you. This warranty gives you specific legal rights, and you may also have other rights which vary from state to state.

GENERAL SAFETY RULES

WARNING!

Read all instructions. Failure to follow all instructions listed below may result in electric shock, fire and/or serious injury. The term “power tool” in all of the warnings listed below refers to your mains-operated (corded) power tool or battery-operated (cordless) power tool.

SAVE THESE INSTRUCTIONS

WORK AREA SAFETY

- **Keep work area clean and well lit.** Cluttered or dark areas invite accidents.
- **Do not operate power tools in explosive atmospheres, such as in the presence of flammable liquids, gases or dust.** Power tools create sparks which may ignite the dust or fumes.
- **Keep children and bystanders away while operating a power tool.** Distractions can cause you to lose control.

ELECTRICAL SAFETY

- **Power tool plugs must match the outlet. Never modify the plug in any way. Do not use any adapter plugs with earthed (grounded) power tools.** Unmodified plugs and matching outlets will reduce risk of electric shock.
- **Avoid body contact with earthed or grounded surfaces such as pipes, radiators, ranges and refrigerators.** There is an increased risk of electric shock if your body is earthed or grounded.
- **Do not expose power tools to rain or wet conditions.** Water entering a power tool will increase the risk of electric shock.
- **Do not abuse the cord. Never use the cord for carrying, pulling or unplugging the power tool. Keep cord away from heat, oil, sharp edges or moving parts.** Damaged or entangled cords increase the risk of electric shock.
- **When operating a power tool outdoors, use an extension cord suitable for outdoor use.** Use of a cord suitable for outdoor use reduces the risk of electric shock.
- **Use battery only with charger listed.**

MODEL	BATTERY PACK (P100)	CHARGER (P110)
P410	130255004 or 130224028	1423701, 140237023 or 140237021

PERSONAL SAFETY

- **Stay alert, watch what you are doing and use common sense when operating a power tool. Do not use a power tool while you are tired or under the influence of drugs, alcohol or medication.** A moment of inattention while operating power tools may result in serious personal injury.

- **Use safety equipment. Always wear eye protection.** Safety equipment such as dust mask, non-skid safety shoes, hard hat, or hearing protection used for appropriate conditions will reduce personal injuries.
- **Avoid accidental starting. Ensure the switch is in the off-position before plugging in.** Carrying power tools with your finger on the switch or plugging in power tools that have the switch on invites accidents.
- **Remove any adjusting key or wrench before turning the power tool on.** A wrench or a key left attached to a rotating part of the power tool may result in personal injury.
- **Do not overreach. Keep proper footing and balance at all times.** This enables better control of the power tool in unexpected situations.
- **Dress properly. Do not wear loose clothing or jewelry. Keep your hair, clothing and gloves away from moving parts.** Loose clothes, jewelry or long hair can be caught in moving parts.
- **If devices are provided for the connection of dust extraction and collection facilities, ensure these are connected and properly used.** Use of these devices can reduce dust-related hazards.
- **Do not wear loose clothing or jewelry. Contain long hair.** Loose clothes, jewelry, or long hair can be drawn into air vents.
- **Do not use on a ladder or unstable support.** Stable footing on a solid surface enables better control of the power tool in unexpected situations.

POWER TOOL USE AND CARE

- **Do not force the power tool. Use the correct power tool for your application.** The correct power tool will do the job better and safer at the rate for which it was designed.
- **Do not use the power tool if the switch does not turn it on and off.** Any power tool that cannot be controlled with the switch is dangerous and must be repaired.
- **Disconnect the plug from the power source and/or the battery pack from the power tool before making any adjustments, changing accessories, or storing power tools.** Such preventive safety measures reduce the risk of starting the power tool accidentally.
- **Store idle power tools out of the reach of children and do not allow persons unfamiliar with the power tool or these instructions to operate the power tool.** Power tools are dangerous in the hands of untrained users.
- **Maintain power tools. Check for misalignment or binding of moving parts, breakage of parts and any other condition that may affect the power tool's operation. If damaged, have the power tool repaired before use.** Many accidents are caused by poorly maintained power tools.
- **Keep cutting tools sharp and clean.** Properly maintained cutting tools with sharp cutting edges are less likely to bind and are easier to control.

GENERAL SAFETY RULES

- **Use the power tool, accessories and tool bits etc., in accordance with these instructions and in the manner intended for the particular type of power tool, taking into account the working conditions and the work to be performed.** Use of the power tool for operations different from those intended could result in a hazardous situation.

BATTERY TOOL USE AND CARE

- **Ensure the switch is in the off position before inserting battery pack.** Inserting the battery pack into power tools that have the switch on invites accidents.
- **Recharge only with the charger specified by the manufacturer.** A charger that is suitable for one type of battery pack may create a risk of fire when used with another battery pack.
- **Use power tools only with specifically designated battery packs.** Use of any other battery packs may create a risk of injury and fire.
- **When battery pack is not in use, keep it away from other metal objects like paper clips, coins, keys, nails, screws, or other small metal objects that can make a**

connection from one terminal to another. Shorting the battery terminals together may cause burns or a fire.

- **Under abusive conditions, liquid may be ejected from the battery, avoid contact. If contact accidentally occurs, flush with water. If liquid contacts eyes, additionally seek medical help.** Liquid ejected from the battery may cause irritation or burns.

SERVICE

- **Have your power tool serviced by a qualified repair person using only identical replacement parts.** This will ensure that the safety of the power tool is maintained.



WARNING!

To reduce the risk of injury, user must read instruction manual.

- **When servicing a power tool, use only identical replacement parts. Follow instructions in the Maintenance section of this manual.** Use of unauthorized parts or failure to follow Maintenance instructions may create a risk of shock or injury.

SPECIFIC SAFETY RULES

- **Hold power tools by insulated gripping surfaces when performing an operation where the cutting tool may contact hidden wiring or its own cord.** Contact with a “live” wire will also make exposed metal parts of the tool “live” and shock the operator.
- **Know your power tool. Read operator’s manual carefully. Learn its applications and limitations, as well as the specific potential hazards related to this power tool.** Following this rule will reduce the risk of electric shock, fire, or serious injury.
- **Always wear safety glasses with side shields.** Everyday glasses have only impact resistant lenses. They are NOT safety glasses. Following this rule will reduce the risk of eye injury.
- **Protect your lungs. Wear a face or dust mask if the operation is dusty.** Following this rule will reduce the risk of serious personal injury.
- **Protect your hearing. Wear hearing protection during extended periods of operation.** Following this rule will reduce the risk of serious personal injury.
- **Battery tools do not have to be plugged into an electrical outlet; therefore, they are always in operating condition. Be aware of possible hazards when not using your battery tool or when changing accessories.** Following this rule will reduce the risk of electric shock, fire, or serious personal injury.
- **Do not place battery tools or their batteries near fire or heat.** This will reduce the risk of explosion and possibly injury.

- **Do not crush, drop or damage battery pack. Do not use a battery pack or charger that has been dropped or received a sharp blow.** A damaged battery is subject to explosion. Properly dispose of a dropped or damaged battery immediately.
- **Batteries vent hydrogen gas and can explode in the presence of a source of ignition, such as a pilot light.** To reduce the risk of serious personal injury, never use any cordless product in the presence of open flame. An exploded battery can propel debris and chemicals. If exposed, flush with water immediately.
- **Do not charge battery tool in a damp or wet location.** Following this rule will reduce the risk of electric shock.
- **For best results, your battery tool should be charged in a location where the temperature is more than 50°F but less than 100°F.** To reduce the risk of serious personal injury, do not store outside or in vehicles.
- **Under extreme usage or temperature conditions, battery leakage may occur. If liquid comes in contact with your skin, wash immediately with soap and water, then neutralize with lemon juice or vinegar. If liquid gets into your eyes, flush them with clean water for at least 10 minutes, then seek immediate medical attention.** Following this rule will reduce the risk of serious personal injury.
- **If the power supply cord is damaged, it must be replaced only by the manufacturer or by an authorized service center to avoid risk.**

SAFETY RULES FOR CHARGER

WARNING!

READ AND UNDERSTAND ALL INSTRUCTIONS.

Failure to follow all instructions listed below, may result in electric shock, fire and/or serious personal injury.

- **Before using battery charger**, read all instructions and cautionary markings in this manual, on battery charger, battery, and product using battery to prevent misuse of the products and possible injury or damage.

CAUTION:

To reduce the risk of electric shock or damage to the charger and battery, charge only nickel-cadmium rechargeable batteries as specifically designated on your charger. Other types of batteries may burst, causing personal injury or damage.

- **Do not use charger outdoors or expose to wet or damp conditions.** Water entering charger will increase the risk of electric shock.
- **Use of an attachment not recommended or sold by the battery charger manufacturer may result in a risk of fire, electric shock, or injury to persons.** Following this rule will reduce the risk of electric shock, fire, or serious personal injury.
- **Do not abuse cord or charger.** Never use the cord to carry the charger. Do not pull the charger cord rather than the plug when disconnecting from receptacle. Damage to the cord or charger could occur and create an electric shock hazard. Replace damaged cords immediately.
- **Make sure cord is located so that it will not be stepped on, tripped over, come in contact with sharp edges or moving parts or otherwise subjected to damage or stress.** This will reduce the risk of accidental falls, which could cause injury, and damage to the cord, which could result in electric shock.
- **Keep cord and charger from heat to prevent damage to housing or internal parts.**
- **Do not let gasoline, oils, petroleum-based products, etc. come in contact with plastic parts.** They contain chemicals that can damage, weaken, or destroy plastic.

- **An extension cord should not be used unless absolutely necessary.** Use of improper extension cord could result in a risk of fire and electric shock. If extension cord must be used, make sure:

- a. That pins on plug of extension cord are the same number, size and shape as those of plug on charger.
- b. That extension cord is properly wired and in good electrical condition; and
- c. That wire size is large enough for AC ampere rating of charger as specified below:

Cord Length (Feet)	25'	50'	100'
Cord Size (AWG)	16	16	16

NOTE: AWG = American Wire Gauge

- **Do not operate charger with a damaged cord or plug**, which could cause shorting and electric shock. If damaged, have the charger replaced by an authorized serviceman.
- **Do not operate charger if it has received a sharp blow, been dropped, or otherwise damaged in any way.** Take it to an authorized serviceman for electrical check to determine if the charger is in good working order.
- **Do not disassemble charger.** Take it to an authorized serviceman when service or repair is required. Incorrect reassembly may result in a risk of electric shock or fire.
- **Unplug charger from outlet before attempting any maintenance or cleaning to reduce the risk of electric shock.**
- **Disconnect charger from the power supply when not in use.** This will reduce the risk of electric shock or damage to the charger if metal items should fall into the opening. It also will help prevent damage to the charger during a power surge.
- **Risk of electric shock.** Do not touch uninsulated portion of output connector or uninsulated battery terminal.
- **Save these instructions.** Refer to them frequently and use them to instruct others who may use this tool. If you loan someone this tool, loan them these instructions also to prevent misuse of the product and possible injury.

IMPORTANT SAFETY INSTRUCTIONS











1. SAVE THESE INSTRUCTIONS

This manual contains important safety and operating instructions for battery chargers 1423701, 140237023, and 140237021.

2. **Before using battery charger**, read all instructions and cautionary markings on battery charger, battery, and product using battery.
3. **CAUTION:** To reduce the risk of injury, charge only nickel-cadmium rechargeable batteries. Other types of batteries may burst, causing personal injury or damage.



SYMBOLS

Some of the following symbols may be used on this product. Please study them and learn their meaning. Proper interpretation of these symbols will allow you to operate the product better and safer.

SYMBOL	NAME	DESIGNATION/EXPLANATION
V	Volts	Voltage
A	Amperes	Current
Hz	Hertz	Frequency (cycles per second)
W	Watt	Power
min	Minutes	Time
~	Alternating Current	Type of current
≡	Direct Current	Type or a characteristic of current
n_0	No Load Speed	Rotational speed, at no load
	Class II Tool	Double-insulated construction
.../min	Per Minute	Revolutions, strokes, surface speed, orbits etc., per minute
	Wet Conditions Alert	Do not expose to rain or use in damp locations.
	Read The Operator's Manual	To reduce the risk of injury, user must read and understand operator's manual before using this product.
	Eye Protection	Always wear safety goggles or safety glasses with side shields and, as necessary, a full face shield when operating this product.
	Safety Alert	Precautions that involve your safety.
	No Hands Symbol	Failure to keep your hands away from the blade will result in serious personal injury.
	No Hands Symbol	Failure to keep your hands away from the blade will result in serious personal injury.
	No Hands Symbol	Failure to keep your hands away from the blade will result in serious personal injury.
	No Hands Symbol	Failure to keep your hands away from the blade will result in serious personal injury.
	Hot Surface	To reduce the risk of injury or damage, avoid contact with any hot surface.

SYMBOLS

The following signal words and meanings are intended to explain the levels of risk associated with this product.

SYMBOL	SIGNAL	MEANING
	DANGER:	Indicates an imminently hazardous situation, which, if not avoided, will result in death or serious injury.
	WARNING:	Indicates a potentially hazardous situation, which, if not avoided, could result in death or serious injury.
	CAUTION:	Indicates a potentially hazardous situation, which, if not avoided, may result in minor or moderate injury.
	CAUTION:	(Without Safety Alert Symbol) Indicates a situation that may result in property damage.

SERVICE

Servicing requires extreme care and knowledge and should be performed only by a qualified service technician. For service we suggest you return the product to the nearest **AUTHORIZED SERVICE CENTER** for repair. When servicing, use only identical replacement parts.



WARNING:

To avoid serious personal injury, do not attempt to use this product until you read thoroughly and understand completely the operator's manual. If you do not understand the warnings and instructions in the operator's manual, do not use this product. Call Ryobi customer service for assistance.



WARNING:



The operation of any power tool can result in foreign objects being thrown into your eyes, which can result in severe eye damage. Before beginning power tool operation, always wear safety goggles or safety glasses with side shields and, when needed, a full face shield. We recommend Wide Vision Safety Mask for use over eyeglasses or standard safety glasses with side shields. Always use eye protection which is marked to comply with ANSI Z87.1.

SAVE THESE INSTRUCTIONS

FEATURES

PRODUCT SPECIFICATIONS

Orbit Diameter 1/16 in.
Motor 18 Volt DC
No Load Speed 10,000 r/min. (RPM)

Charger Input 120 V, 60 Hz, AC only
Charge Rate 1 hour

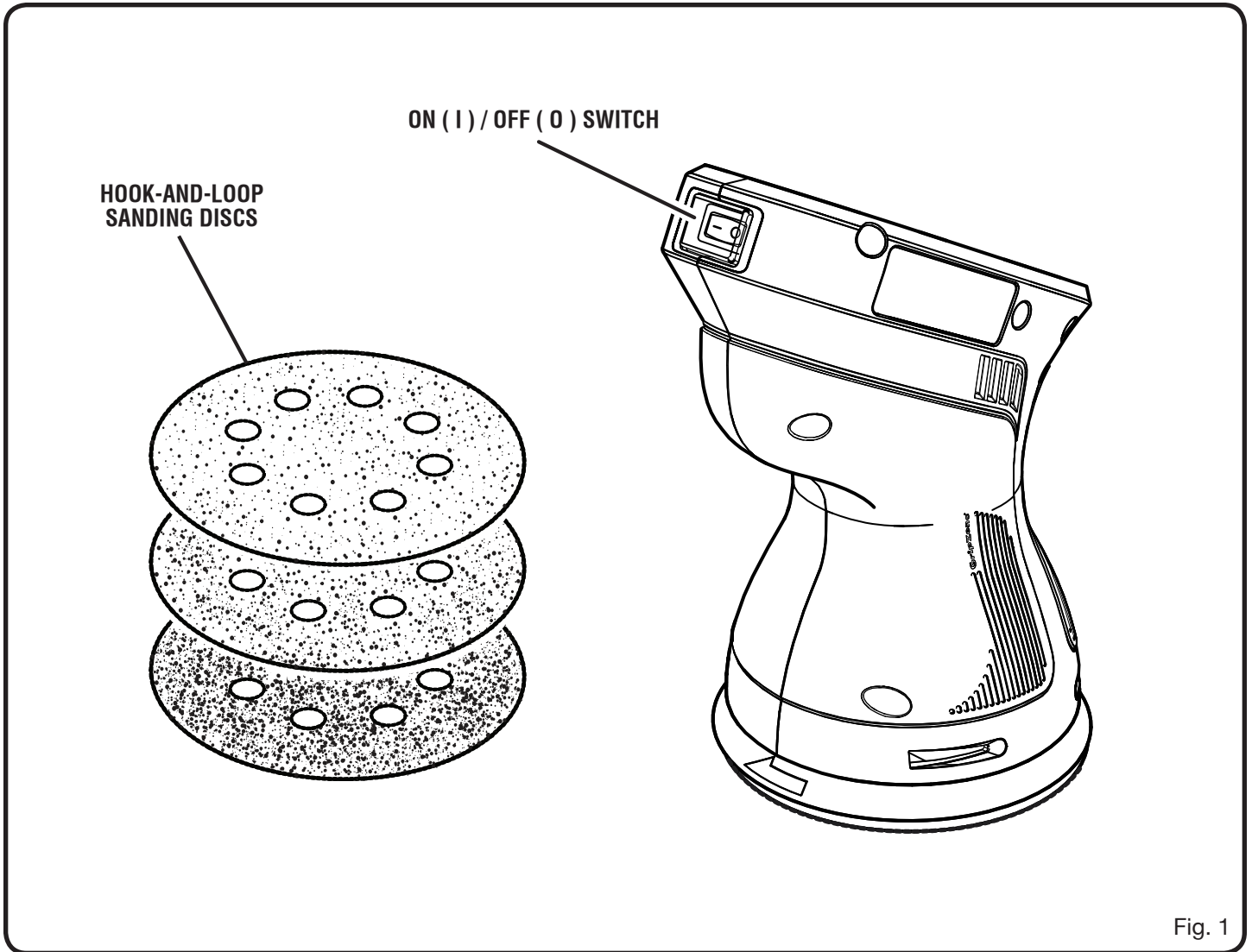

Fig. 1

FEATURES

KNOW YOUR SANDER

See Figure 1.

The safe use of this product requires an understanding of the information on the product and in this operator's manual as well as a knowledge of the project you are attempting. Before use of this product, familiarize yourself with all operating features and safety rules.

ON/OFF SWITCH

The **ON (I) / OFF (O)** slide switch is located on the front of the tool.

ORBITAL SANDING ACTION

The oscillating action of your sander produces a very quick, small circular motion of the sanding pad. The motion is ideal for producing a fine finished grain.

QUICK CHANGE HOOK-AND-LOOP PAD

The hook-and-loop design allows for quick change of sanding sheets. It also enables you to easily clean and reuse them.

ASSEMBLY

UNPACKING

This product has been shipped completely assembled.

- Carefully remove the product and any accessories from the box. Make sure that all items listed in the packing list are included.
- Inspect the product carefully to make sure no breakage or damage occurred during shipping.
- Do not discard the packing material until you have carefully inspected and satisfactorily operated the product.
- If any parts are damaged or missing, please call 1-800-525-2579 for assistance.

PACKING LIST

Sander
Sanding Disc, 60-grit
Sanding Disc, 120-grit
Sanding Disc, 240-grit
Operator's Manual

WARNING:

If any parts are damaged or missing do not operate this product until the parts are replaced. Failure to heed this warning could result in serious personal injury.

WARNING:

Do not attempt to modify this product or create accessories not recommended for use with this product. Any such alteration or modification is misuse and could result in a hazardous condition leading to possible serious personal injury.

WARNING:

To prevent accidental starting that could cause serious personal injury, always remove the battery pack from the product when assembling parts.

OPERATION

WARNING:

Do not allow familiarity with products to make you careless. Remember that a careless fraction of a second is sufficient to inflict serious injury.

WARNING:

Always wear safety goggles or safety glasses with side shields when operating products. Failure to do so could result in objects being thrown into your eyes, resulting in possible serious injury.

WARNING:

Do not use any attachments or accessories not recommended by the manufacturer of this product. The use of attachments or accessories not recommended can result in serious personal injury.

APPLICATIONS

You may use this product for the purposes listed below:

- Sanding on wood surfaces
- Removing rust from and sanding steel surfaces

CAUTION:

If at any point during the charging process none of the LEDs are lit, remove the battery pack from the charger to avoid damaging the product. DO NOT insert another battery. Return the charger and battery to your nearest service center for service or replacement.

LED FUNCTIONS OF CHARGER

LED WILL BE ON TO INDICATE STATUS OF CHARGER AND BATTERY PACK:

- Red LED on = Fast charging mode.
- Green LED on = Fully charged and in maintenance charge mode.
- Green LED on = When battery pack is inserted into charger, indicates hot battery pack or that battery pack is out of normal temperature range.
- Yellow and Green LEDs on = Deeply discharged or defective battery pack.
- No LED on = Defective charger or battery pack.

CHARGING THE BATTERY PACK

Battery packs for this product have been shipped in a low charge condition to prevent possible problems. Therefore, you should charge it until the green LED on the front of the charger comes on.

NOTE: Batteries will not reach full charge the first time they are charged. Allow several cycles (operation followed by recharging) for them to become fully charged.

CHARGING A COOL BATTERY PACK

If battery pack is within normal temperature range, the red LED on charger will come on.

NOTE: If the charger does not charge the battery pack under normal circumstances, return both the battery pack and charger to your nearest Authorized Service Center for electrical check.

- Charge the battery pack only with the charger provided.
- Make sure the power supply is normal household voltage, **120 volts, 60 Hz, AC only.**
- Connect the charger to the power supply.
- Place the battery pack in the charger aligning raised rib on the battery pack with the groove in the charger. *See Figure 2.*
- Press down on the battery pack to be sure contacts on the battery pack engage properly with contacts in the charger.
- Normally the red LED on charger will come on. This indicates the charger is in fast charging mode.
- Red LED should remain on for approximately 1 hour then the green LED will come on. Green LED on indicates battery pack is fully charged and charger is in maintenance charge mode.

NOTE: The green LED will remain on until the battery pack is removed from the charger or charger is disconnected from the power supply.

- If both yellow and green LEDs come on, this indicates a deeply discharged or defective battery pack. Allow the battery pack to remain in the charger for 15 to 30 minutes. When the battery pack reaches normal voltage range, the red LED should come on. If the red LED does not come on after 30 minutes, this may indicate a defective battery pack that should be replaced.
- After normal usage, a minimum of 1 hour of charging time is required to fully recharge battery pack.
- The battery pack will become slightly warm to the touch while charging. This is normal and does not indicate a problem.
- Do not place the charger and battery pack in an area of extreme heat or cold. They will work best at normal room temperature.
NOTE: The charger and battery pack should be placed in a location where the temperature is more than 50°F but less than 100°F.
- When batteries become fully charged, unplug the charger from power supply and remove the battery pack.

OPERATION

CHARGING A HOT BATTERY PACK

When using the product continuously, the batteries in the battery pack will become hot. You should let a hot battery pack cool down for approximately 30 minutes before attempting to recharge. When the battery pack becomes discharged and is hot, this will cause the green LED to come on instead of the red LED. After 30 minutes, reinsert the battery pack in the charger. If the green LED continues to remain on, return battery pack to your nearest Authorized Service Center for checking or replacing.

NOTE: This situation only occurs when continuous use of the product causes the batteries to become hot. It does not occur under normal circumstances. Refer to **CHARGING A COOL BATTERY PACK** for normal recharging of batteries. If the charger does not charge the battery pack under normal circumstances, return both the battery pack and charger to your nearest Authorized Service Center for electrical check.

WARNING:

Battery products are always in operating condition. Therefore, the switch should always be locked when not in use or carrying at your side.

TURNING THE SANDER ON (I)/OFF (O)

See Figure 3.

- Install the battery pack.
- To turn **ON** the sander: push the ON (I)/OFF (O) switch to the (I) position.
- To turn **OFF** the sander: push the ON (I)/OFF (O) switch to the (O) position.

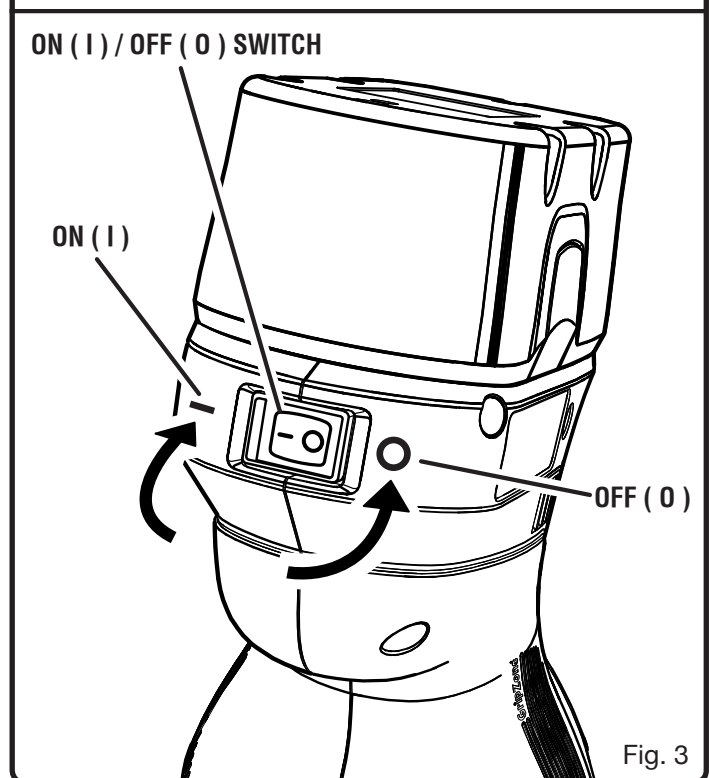
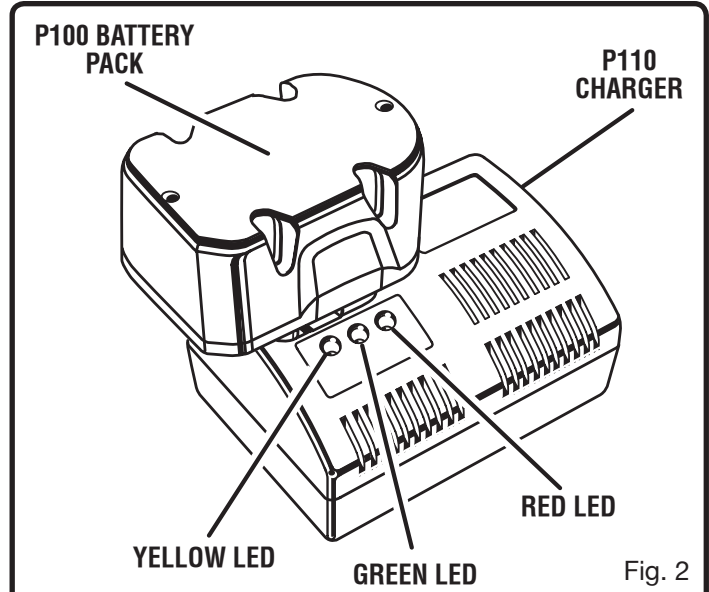

OPERATION

TO INSTALL BATTERY PACK

See Figure 4.

- Place the battery pack on the tool.
- Make sure the latches on each side of the battery pack snap into place and the battery pack is secured on the tool before beginning operation.

TO REMOVE BATTERY PACK

See Figure 4.

- Depress the latches on the side of battery pack.
- Remove the battery pack from the tool.

SANDING DISC SELECTION

Selecting the correct size grit and type sanding disc is an extremely important step in achieving a high-quality sanded finish. Aluminum oxide, silicon carbide, and other synthetic abrasives are best for power sanding. Natural abrasives, such as flint and garnet are too soft for economical use in power sanding.

In general, coarse grit will remove the most material and finer grit will produce the best finish in all sanding operations. The condition of the surface to be sanded will determine which grit will do the job. If the surface is rough, start with a coarse grit and sand until the surface is uniform. Medium grit may then be used to remove scratches left by the coarser grit and finer grit used for finishing of the surface. Always continue sanding with each grit until surface is uniform.

ATTACHING HOOK-AND-LOOP SANDING DISC

See Figure 5.

To attach hook-and-loop sanding disc:

- Remove battery pack from sander.
- Align the holes in the sanding disc with the holes in the hook-and-loop backing pad.
- Press the sanding disc against the backing pad as firmly as possible.

NOTE: To provide for the best adhesion, we recommend that you clean the backing pad and the sanding disc backing occasionally by brushing them lightly with a small brush.

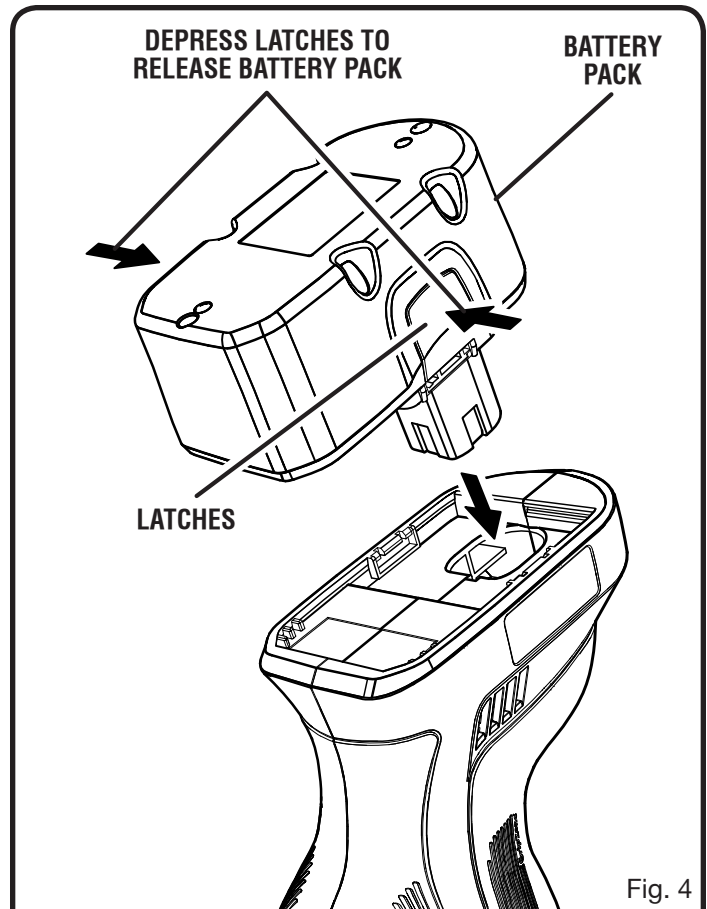

Fig. 4

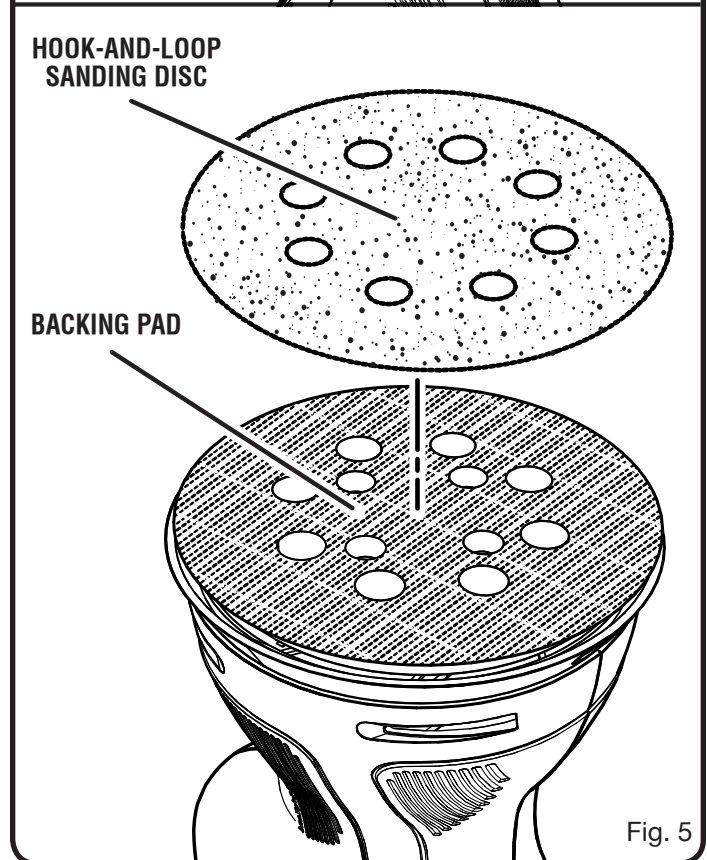

Fig. 5

OPERATION

OPERATING THE SANDER

See Figure 6.

- Secure the workpiece to prevent it from moving during operation.

WARNING:

Unsecured workpieces could be thrown towards the operator causing injury.

WARNING:

Keep your head away from the sander and the sanding area. Your hair could be drawn into the sander, causing serious injury.

- Place the sander on the workpiece so that all of the sanding disc surface is in contact with the workpiece.

CAUTION:

To avoid motor damage resulting from overheating, do not cover the air vents with your hand.

- Turn on the sander and move it slowly over the workpiece. Make successive passes in parallel lines, circles, or crosswise movements.
- Turn off the sander and wait until the sanding disc comes to a complete stop before removing it from the workpiece.

Do not force. The weight of the sander supplies adequate pressure to do the work. Applying additional pressure only slows the motor, rapidly wears the sanding sheet, and greatly reduces sander speed. Excessive pressure will overload the motor causing possible damage from overheating and can result in inferior work. Any finish or resin on wood may soften from the frictional heat. Do not sand on one spot too long as the sander's rapid action may remove too much material, making the surface uneven.

Extended periods of sanding may overheat the motor. If this occurs, turn the sander off and wait until the sanding sheet comes to a complete stop. Remove sander from workpiece. Remove sanding disc, then turn sander on and run it free without a load to cool the motor.

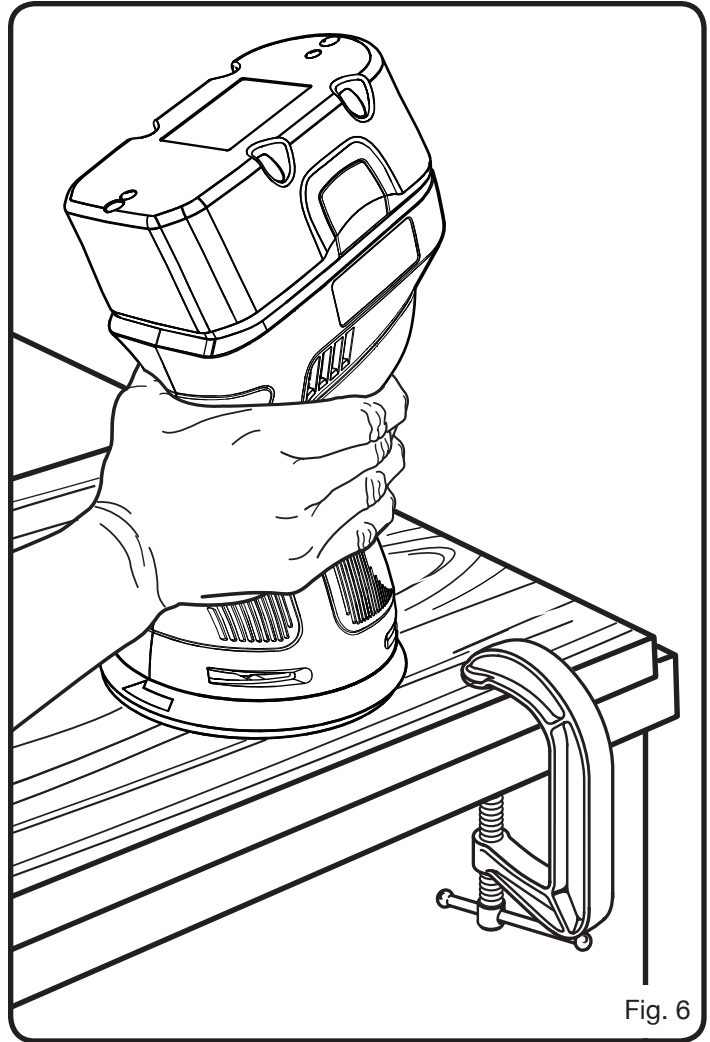

Fig. 6

MAINTENANCE

WARNING:

When servicing, use only identical replacement parts. Use of any other parts may create a hazard or cause product damage.

WARNING:

Always wear safety goggles or safety glasses with side shields during product operation or when blowing dust. If operation is dusty, also wear a dust mask.

WARNING:

To avoid serious personal injury, always remove the battery pack from the product when cleaning or performing any maintenance.

GENERAL MAINTENANCE

Avoid using solvents when cleaning plastic parts. Most plastics are susceptible to damage from various types of commercial solvents and may be damaged by their use. Use clean cloths to remove dirt, dust, oil, grease, etc.

WARNING:

Do not at any time let brake fluids, gasoline, petroleum-based products, penetrating oils, etc., come in contact with plastic parts. Chemicals can damage, weaken or destroy plastic which may result in serious personal injury.

Only the parts shown on the parts list are intended to be repaired or replaced by the customer. All other parts should be replaced at an Authorized Service Center.

BATTERIES

The battery pack for this product is equipped with nickel-cadmium rechargeable batteries. Length of service from each charging will depend on the type of work you are doing.

The batteries in this product have been designed to provide maximum trouble-free life. However, like all batteries, they will eventually wear out. **Do not** disassemble battery pack and attempt to replace the batteries. Handling of these batteries, especially when wearing rings and jewelry, could result in a serious burn.

To obtain the longest possible battery life, we suggest the following:

- Remove the battery pack from the charger once it is fully charged and ready for use.

For battery storage longer than 30 days:

- Store the battery pack where the temperature is below 80°F.
- Store battery packs in a “discharged” condition.

BATTERY PACK REMOVAL AND PREPARATION FOR RECYCLING



To preserve natural resources, please recycle or dispose of batteries properly.

This product contains nickel-cadmium batteries. Local, state or federal laws may prohibit disposal of nickel-cadmium batteries in ordinary trash.

Consult your local waste authority for information regarding available recycling and/or disposal options.

WARNING:

Upon removal, cover the battery pack's terminals with heavy-duty adhesive tape. Do not attempt to destroy or disassemble battery pack or remove any of its components. Nickel-cadmium batteries must be recycled or disposed of properly. Also, never touch both terminals with metal objects and/or body parts as short circuit may result. Keep away from children. Failure to comply with these warnings could result in fire and/or serious injury.



OPERATOR'S MANUAL

18 VOLT RANDOM ORBIT SANDER

P410

WARNING:

Some dust created by power sanding, sawing, grinding, drilling, and other construction activities contains chemicals known to cause cancer, birth defects or other reproductive harm. Some examples of these chemicals are:

- lead from lead-based paints,
- crystalline silica from bricks and cement and other masonry products, and
- arsenic and chromium from chemically-treated lumber.

Your risk from these exposures varies, depending on how often you do this type of work. To reduce your exposure to these chemicals: work in a well ventilated area, and work with approved safety equipment, such as those dust masks that are specially designed to filter out microscopic particles.

• SERVICE

Now that you have purchased your product, should a need ever exist for repair parts or service, simply contact your nearest Authorized Service Center. Be sure to provide all pertinent facts when you call or visit. Please call 1-800-525-2579 for your nearest Authorized Service Center. You can also check our web site at www.ryobitools.com for a complete list of Authorized Service Centers.

• MODEL NO. AND SERIAL NO.

The model number of this product will be found on a plate attached to the motor housing. Please record the model number and serial number in the space provided below.

• HOW TO ORDER REPAIR PARTS

When ordering repair parts, always give the following information:

- MODEL NUMBER P410
- SERIAL NUMBER

Ryobi® is a registered trademark of Ryobi Limited used under license.

ONE WORLD TECHNOLOGIES, INC.

1428 Pearman Dairy Road, Anderson, SC 29625

Phone 1-800-525-2579

www.ryobitools.com