



Excel. Defy. Inspire.



MoistureShield
COMPOSITE DECKING

Meet the Next Level in Outdoor Living

Our offering provides beautiful wood composite boards for every home - from the party host to the growing family. Create bold and inspired outdoor living spaces that stand up to the effects of weather and wear with our diverse collection of products.



Excel Everyday. Product innovations that improve your everyday life, offering enduring beauty that reduces the need for routine maintenance.

Defy Ordinary. Built to outlast the elements, our wood composite deck boards can be installed on the ground, in the ground or underwater.

Inspire Life. Create inspired outdoor living spaces, from the Social Spot to the Play Area, with gorgeous finishes and unmatched performance.

zerO Failures



We're the only decking product with zero structural field failures for more than 30 years. Visit our website to learn more about why that matters and how we stack up against the competition. [MoistureShield.com/Why-MoistureShield](https://www.moistureshield.com/Why-MoistureShield)

Sustainability Matters

We are committed to the ways our products contribute to a greener tomorrow.

We care about every material that goes into our boards. That's why our environmentally friendly products are made from **95% recycled content** and can help earn credit in LEED® green building rating programs.

With every composite board that is manufactured using our sustainable methods, we reduce our consumption of limited natural resources, curb emissions of greenhouse gases and contribute to building a more sustainable world for future generations.

Building with MoistureShield composite decking is equivalent to:



Diverting
100M lbs
of waste from
landfills each year



Saving
110 Gallons
of gas per deck



Reducing
1,500 lbs
of CO₂ emissions
per deck



Reducing
45,000 Cars
worth of greenhouse
gas emissions
annually

100+ million pounds of waste =
7.5 football fields
10 feet deep

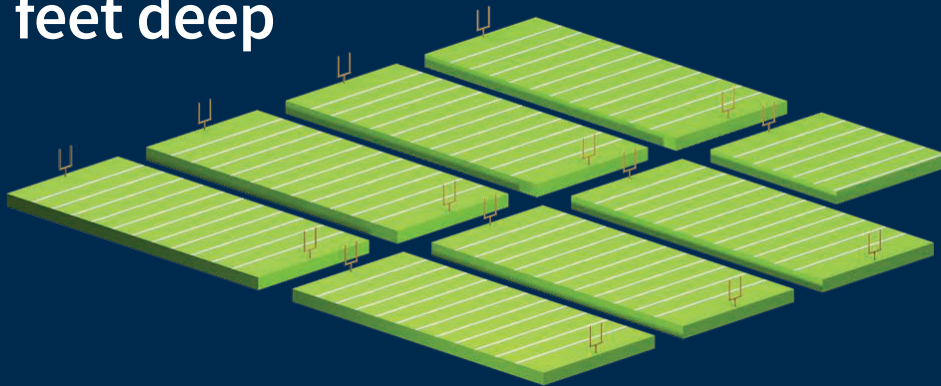

The Solid Core Difference™

MoistureShield offers the only wood composite boards in the industry that can be installed on the ground, in the ground or underwater without any structural performance issues. At the foundation of every board is our proprietary Solid Core — an impermeable barrier that fights damage from moisture, rot, insects and other harmful elements. Our core maintains its integrity even after ripping and cutting, mitigating warranty issues and long-term damage.

Choose Solid Core and create outdoor spaces that stand up to the effects of weather and wear — day in and day out.



Wood fibers are individually encapsulated in plastic

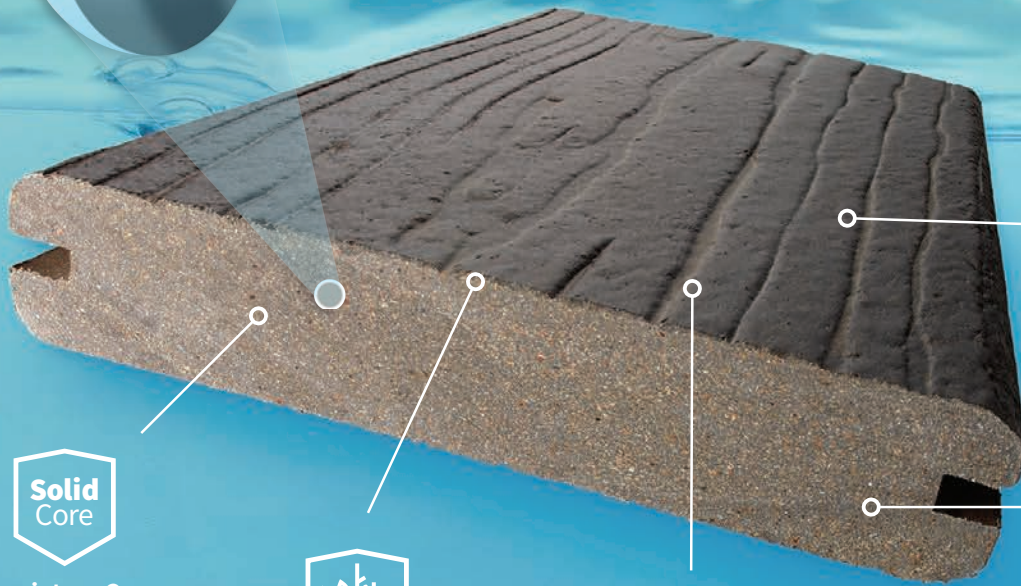

Proprietary Core for Unmatched Durability



No Warping or Rotting



Zero Structural Field Failures in 30+ Years



Virtually No Moisture Absorption



Resists Damage from Insects

Excel Through Innovation

Our technology sets MoistureShield decking above the rest.

It started with the Solid Core Difference, and today we continue to design our boards to defy the elements and inspire better living for years to come. That's why we've introduced industry-leading innovations like our CoolDeck® Technology, keeping our boards cooler in hot environments, developing boards that are more authentic and beautiful and creating the strongest composite cap on the market. We've kept our focus on innovation for more than 30 years.



Comfort.



CoolDeck® Technology

Finally, composite decking that stays comfortable all season long, when every degree counts. On a hot summer day, a deck can reach temperatures of more than 160°F. That's why we designed the only composite wood decking that absorbs up to 35% less heat* than standard capped composite decking, staying cooler in extreme heat.

MoistureShield with
CoolDeck Technology

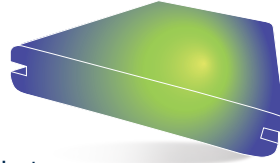

VS

Standard Capped
Composite Decking

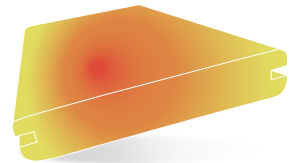

Up to
35% Cooler

160°F+

* Compared to standard capped composites.
CoolDeck Technology is available in select colors in the Vision and Infuse lines.

Durability.

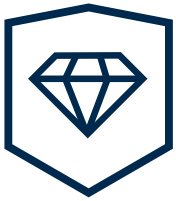

DiamondDefense™ Coating

You choose composite decking to avoid maintenance like painting and staining, so why settle for products that scratch or chip on impact? Our DiamondDefense Coating creates the strongest capped wood composite board on the market to protect your deck against everyday damage to stay looking like new for longer.



Beauty.



Co-X™ Manufacturing Process

For the most discerning tastes, our Infuse decking, made with our proprietary Co-X manufacturing process, has all the authentic beauty of real wood without the maintenance. With a true wood grain finish and self-healing cap, Infuse composite decking weathers into an attractive patina that won't fade over time.



Excel Everyday





Our Products

Our offering provides beautiful options for every project. Create bold and inspired outdoor living spaces that stand up to the effects of weather and wear. All of our products are protected with The Solid Core Difference for unbeatable performance in virtually any environment — from above the ground to underwater — so you can rest assured knowing your investment will last a lifetime.

Vision®

pg. 12-13



Infuse®

pg. 14-15



Elevate™

pg. 16-17



Vantage™

pg. 18-19



Marine Grade 2x

pg. 20-23



Deck Style Meets Lifestyle

The quick product selection guide on this page will help you understand our products at a glance to solve for your needs. For example, families in hot climates and with young children will want to choose products with our CoolDeck Technology. If you have a rustic, wood-heavy interior design or you live in a forested environment, our Infuse decking will pair beautifully. Heavily-trafficked decks should be made with our Vision decking.

Consider the following questions before choosing the right decking:

- Do you have little children or pets?
Choose Vision or Vantage for high slip resistance.
- Does your region experience many hot summer days?
Choose Vision or Infuse with CoolDeck.
- What kind of style do you have in your home?
For a rustic look and feel, choose Infuse.
For modern, refined colors, choose Vision.
- How often do you entertain large groups?
For heavy foot traffic, choose Vision.
- Are you designing a home dock or pier?
For the highest durability: Vision Marine Grade 2x.
For an authentic wood look: Vantage Marine Grade 2x.



Vision® with CoolDeck

Extremely durable decking built for bare feet, pet claws, summer heat and sports cleats

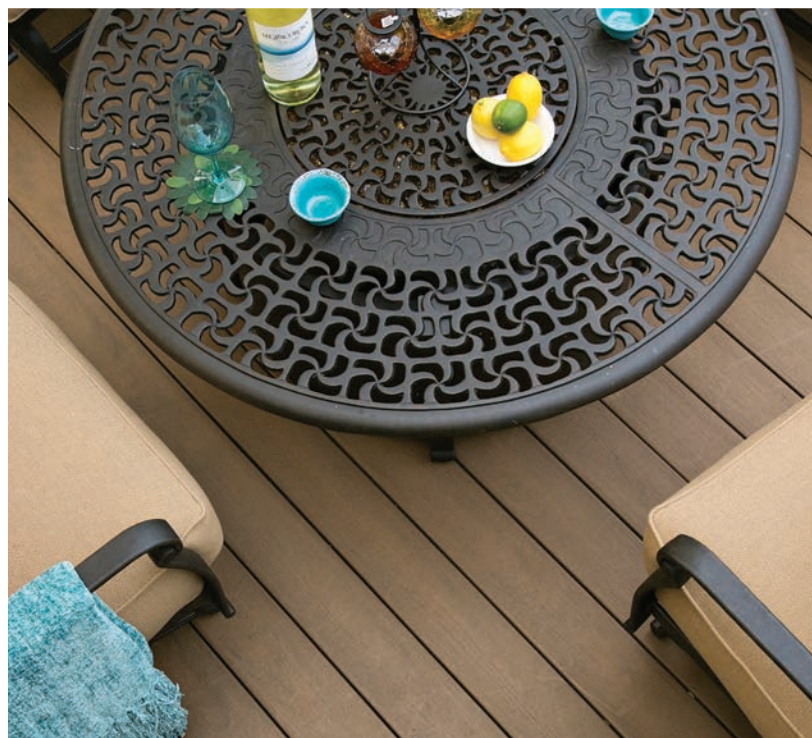

Infuse® with CoolDeck

Authentic premium wood look with colors built to keep even the hottest weather at bay



Elevate™

Affordable and high-performing composite decking with a strong, protective barrier



Vantage™

Specialty decking imitates real wood but resists damage from water and harmful elements



Vision® Marine Grade 2x with CoolDeck

Marine grade boards with CoolDeck, premium durability and our highest slip resistance



Vantage™ Marine Grade 2x

Marine decking that retains the look of real wood with our water-resistant Solid Core

Vision

Bold. Refined. Infinite.

It's time to step up to the future of composite decking. Our strongest capped wood composite board is protected with our exclusive DiamondDefense Coating to exude distinctive style while resisting scratches, stains and damage on impact. Choose from beautiful color options and textures that reflect the look of real hardwood while ensuring unmatched performance features designed to last a lifetime.

- Made with 95% recycled material
- Transferable 50-year structural warranty
- 50-year fade and stain warranty

* Compared to standard capped composites.

For color availability in your region, please contact your MoistureShield representative.



Proprietary
Solid Core



Zero Structural Field
Failures in 30+ Years



DiamondDefense™
Coating



CoolDeck
Technology
Reduces Heat
up to 35%*



Slip
Resistance





1" Grooved Edge Deck Board
 Dimensions 1" x 6" **
 Lengths 12', 16', 20'
 2" x 6" Coming Soon



1" Solid Edge Deck Board
 Dimensions 1" x 6" **
 Lengths 12', 16', 20'



Fascia Board
 Dimensions 0.67" x 11.25"
 Lengths 12'

**For actual board dimensions, see chart in back of brochure.

Available colors



Cathedral Stone
 with CoolDeck Technology



Mochaccino
 with CoolDeck Technology

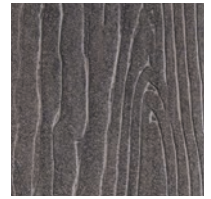

Smokey Gray



Spanish Leather



Sandstone

New colors coming soon

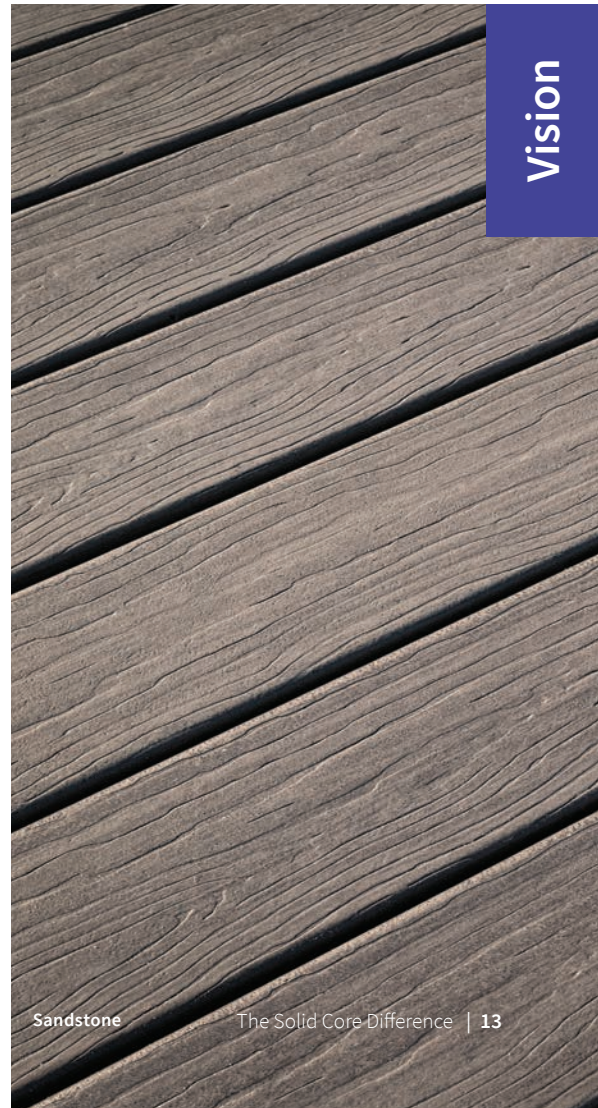

Vision

Infuse

Natural. Rustic. Authentic.

Get the look of real wood grain without the maintenance. Our exclusive wood-infused cap creates a beautiful, resilient, color-enriched board with all the protection and performance benefits of our Solid Core. Create stunning spaces without the upkeep that can be enjoyed for a lifetime.

- Made with 95% recycled material
- Transferable 50-year structural warranty
- 25-year fade and stain warranty



Proprietary
Solid Core



Zero Structural Field
Failures in 30+ Years



Co-X Manufacturing
Process



CoolDeck
Technology
Reduces Heat
up to 35%*



Self-Healing Boards
Minimize Appearance
of Scuffs and Scratches

* Compared to standard capped composites.

For color availability in your region, please contact your MoistureShield representative.





1" Grooved Edge Deck Board
 Dimensions 1" x 6"***
 Lengths 12', 16', 20'



1" Solid Edge Deck Board
 Dimensions 1" x 6"***
 Lengths 12', 16', 20'



Fascia Board
 Dimensions 0.67" x 11.25"
 Lengths 12'

**For actual board dimensions, see chart in back of brochure.

Available colors



Harbor Gray
 with CoolDeck Technology



Rustic Timber
 with CoolDeck Technology



Northern Hickory

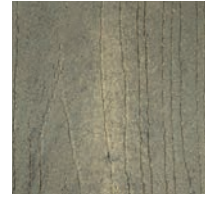

Southern Barnwood



Rosewood

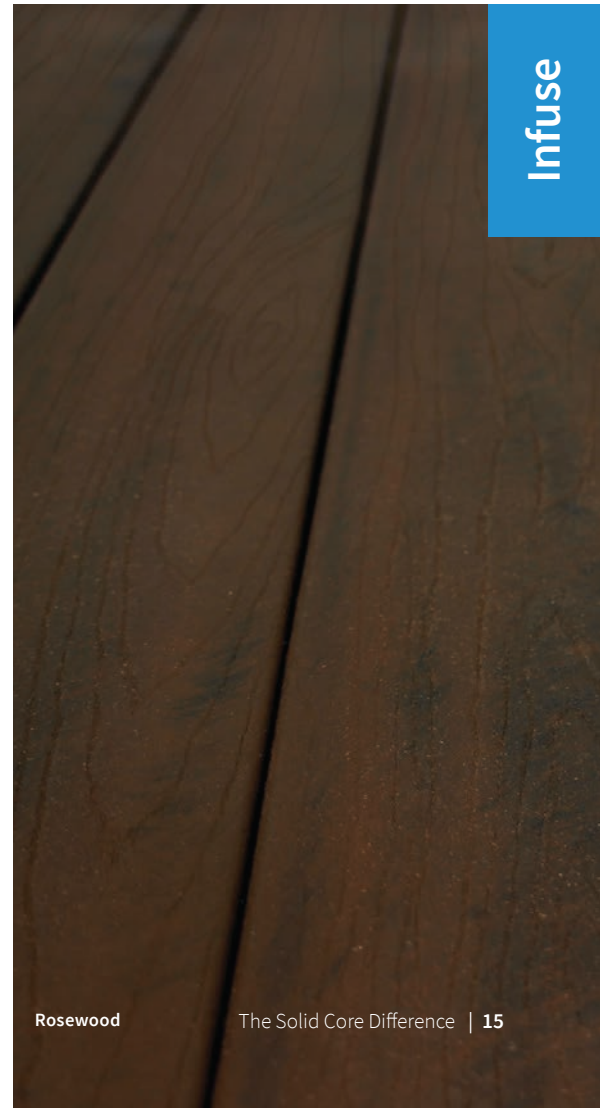

Infuse

Elevate

Strong. Dynamic. Fundamental.

Get advanced protection and beauty without breaking your budget. Our introductory capped wood composite board is shielded with a strong protective barrier to help prevent damage from impact, corrosion and weathering in virtually any environment. Protection paired with straightforward color options allows you to create a stylish, durable outdoor environment simply and affordably. Solid Core runs through the entire board for superior strength and moisture resistance.

- **Made with 95% recycled material**
- **50-Year Structural Warranty**
- **30-Year Fade and Stain Warranty**

For color availability in your region, please contact your MoistureShield representative.



**Proprietary
Solid Core**



**Zero Structural Field
Failures in 30+ Years**



**Slip
Resistance**



Great Value





1" Grooved Edge Deck Board
 Dimensions 1" x 6"***
 Lengths 12', 16', 20'



1" Solid Edge Deck Board
 Dimensions 1" x 6"***
 Lengths 20'



Fascia Board
 Dimensions 0.67" x 11.25"
 Lengths 12'

**For actual board dimensions, see chart in back of brochure.

Available colors



Lake Fog



Canoe

New colors coming soon



Elevate

Vantage

Versatile. Durable. Dependable.

Decking gets an upgrade with a wood composite board that works better than pressure treated lumber. When it comes to creating custom artisan decks, there's no material that cuts, rips or bends better while still maintaining its integrity. That's because our Solid Core runs through the entire board to ensure protection without a cap. As a result, there's no need for painting, staining and yearly repairs with this beautiful decking option that's resistant to moisture, rot and warping.*

And as our most realistic composite wood decking, the high wood fiber content and uncapped construction of Vantage decking means it will weather and lighten in color just like authentic wood. See the weathered swatches on the next page to ensure you'll love the end result.

- **Made with 95% recycled material**
- **Matte finish**
- **Transferable 50-year structural warranty**

*Compared to pressure treated lumber.

For color availability in your region, please contact your MoistureShield representative.



Proprietary
Solid Core



Zero Structural Field
Failures in 30+ Years



Works Like
Real Wood



Self-Healing Boards
Minimize Appearance
of Scuffs and Scratches



Reversible
Boards





1" Grooved Edge Deck Board
 Dimensions 1" x 6"***
 Lengths 12', 16', 20'



2" Solid Edge Deck Board
 Dimensions 2" x 4"***
 Length 12', 16'
 Dimensions 2" x 6", 2" x 8"***
 Length 12', 16', 20'



Fascia Board
 Dimensions 0.67" x 11.25"
 Lengths 12'

**For actual board dimensions, see chart in back of brochure.

Available colors[‡]



Bridle



Earthtone



Cape Cod Gray



Seasoned Mahogany



Rustic Cedar



Walnut

[‡] Vantage boards will naturally lighten to their permanent color within the first six months. Reference these swatches to ensure you'll love the end result.



Marine Grade 2x

For Life On The Water.

Thicker 2x construction for docks, piers, marinas and more.

MoistureShield is the only wood composite decking on the market with virtually no moisture absorption, inside or out. Thanks to the Solid Core Difference, our products can be installed on the water or underwater without damage from warping or swelling, even after cutting. Get all the incredible advantages of our Vision and Vantage in a thicker 2x construction for all marine grade applications.



Proprietary
Solid Core



Zero Structural Field
Failures in 30+ Years



Marine Grade
Spans 24"



Photo credit: Sunrise Docks — Lake Martin



Marine Grade

Vision™ Marine Grade 2x

- CoolDeck Technology to reduce heat
- Resists fading and swelling
- Incredibly durable
- 50-year structural warranty
- 50-year fade and stain warranty



Slip
Resistance



DiamondDefense™
Coating



CoolDeck
Technology
Reduces Heat
up to 35%*

Available colors



Cathedral Stone
with CoolDeck Technology



Mochaccino
with CoolDeck Technology

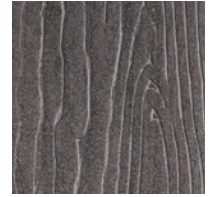

Smokey Gray



Spanish Leather

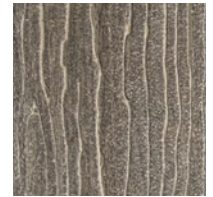

Sandstone



2" Solid Edge Deck Board
Dimensions 2" x 6" **
Lengths 12', 16', 20'



Fascia Board
Dimensions 0.67" x 11.25"
Lengths 12'

* Compared to standard capped composites.

**For actual board dimensions, see chart in back of brochure.



Photo credit: Wade Works

Vantage™ Marine Grade 2x

- No staining or sealing required
- Works like real wood
- 50-year structural warranty



**Self-Healing Boards
Minimize Appearance
of Scuffs and Scratches**



**Reversible
Boards**



**Works like
Real wood**



2" Solid Edge Deck Board
Dimensions 2"x 6", 2"x 8" **
Lengths 12', 16', 20'



Fascia Board
Dimensions 0.67" x 11.25"
Lengths 12'

**For actual board dimensions, see chart in back of brochure.

Available colors†



Bridle



Earthtone



Cape Cod Gray



Seasoned Mahogany



Rustic Cedar



Walnut

† Vantage boards will naturally lighten to their permanent color within the first six months. Reference these swatches to ensure you'll love the end result.



Photo credit: Sunrise Docks - Laurel Ridge



Vision®



Vision®
Marine Grade 2x

Solid Core with Zero Structural
Field Failures in 30+ Years



Surface

DiamondDefense™

DiamondDefense™

CoolDeck® Technology*



Reversible Board

Workable like Wood

Self-Healing

Grooved Edge or Solid

Both

Solid

95% Recycled Content



Fade and Stain Warranty

50-Year

50-Year

50-Year Structural Warranty



Price Range

\$\$\$

\$\$\$

Spans up to

16"

24"

*CoolDeck Technology is available in select colors in the Vision and Infuse lines.



Infuse®



Elevate™



Vantage™



Vantage™
Marine Grade 2x



Co-X™

Traditional Cap

Uncapped

Uncapped



Both

Both

Both

Solid



25-Year

30-Year



\$\$

\$

\$\$

\$\$

16"

16"

16"

24"

Defy Ordinary





Accessories

Just like our decking products, all MoistureShield accessories (from our composite railing systems to our deck lights) are built to be beautiful and tough, with uncompromising attention to detail. Complement your outdoor living space with products to match any style.

Composite Deck Railing

pg. 28



Aluminum Deck Railing

pg. 29

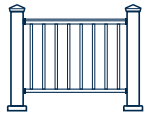

Deck Lights

pg. 30



Hidden Fasteners

pg. 31

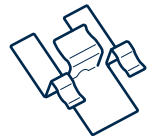

Composite Deck Railing

Complete your outdoor vision with the perfect accessory - railing. Our exclusive composite deck railing systems and accessories are designed to naturally complement all of our decking styles. It's the perfect finishing touch for your extended living space.

Our composite deck railing systems and accessories include:

- 4' x 4' Post
- Post Collar
- Post Cap
- Baluster Kit
- Magnum Railing Kit

All composite railing systems and accessory pieces are sold separately.

* Composite deck railings will naturally lighten to their permanent color within the first six months. Reference these swatches to ensure you'll love the end result.

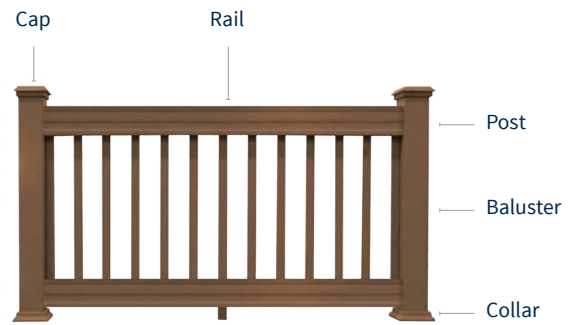

Available colors*



Bridle



Earthtone

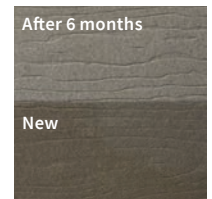

Cape Cod Gray

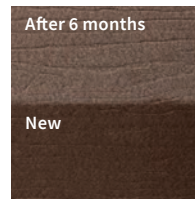

Seasoned Mahogany



Rustic Cedar



Walnut



Aluminum Deck Railing

Our aluminum railing system adds a contemporary edge to any deck design. MoistureShield Pro Aluminum Railing, available in textured black or white, features sophisticated, modern lines that complement every outdoor setting.

Installation is easy, with each section consisting of three kits:

Available colors



Black

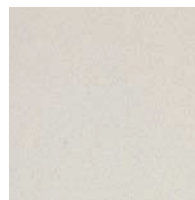

White

1 Rail Kit

- Level rail – 8'
- Fixed stair rail – 8'
Accommodates 32 to 36 degrees and includes rails, balusters and brackets
- Adjustable stair rail – 8'
Baluster mount toggles and pivoting brackets accommodate 0 to 38 degrees

These sections include top and bottom rails, preinstalled balusters connectors, support block, and mounting hardware.

2 Baluster Kit

- 3/4" round or square balusters
- Available in 36" or 42" installed rail height
- Packaged in exact counts for each rail length
- Available in angled cut for fixed stair rail kit

3 Post Kit

- 3" x 3" post, welded mounting base, cap and collar
- Available in 38" and 44" heights

ADA Rail & Accessories

- 8" rail, D-loop, bracket, wall return, transition elbow, flat end plug and rail connector



Deck Lights

Create a completely custom outdoor living space with the right lighting. We offer the perfect selection of deck lighting options to add the right amount of ambiance, elegance and safety to your outdoor environment. All of our LED deck lights are protected by a 5-year warranty when installed with MoistureShield light accessories.



Rail Strips

Add a subtle glow to set apart your outdoor living space. Strips can be cut every 2" for custom rail widths.



Post Lights

Low profile and flat top to complement the design of your deck. Real glass coverings help ensure your lights will continue shining clearly for years.



Post Cap Lights

Fits 3" post
Low profile, flat top



Stair Lights

Gentle light to help keep the party going well after dark. Real glass ensures your lights will continue shining clearly for years.



Bullet Lights

Stylishly accent the transitions and details of your deck. Fits flush against your deck boards.

Order Today at [MoistureShield.com](https://www.moistureshield.com)



Hidden Fasteners

For Wood Composite Decking

Get the most seamless installation possible with our exclusive hidden fasteners. Designed specifically for our wood composite boards, these fasteners provide superior holding power that fits securely into grooved profiles. Hidden fasteners can even add to the life of your deck by elevating the boards off the joists to reduce structural rot and mold. They're even backed by a limited lifetime warranty against any loose deck boards.

Benefits of our hidden decking fasteners include:

- Easy to install with pneumatic fasteners or screws
- Concealed fasteners create an unblemished deck surface
- Allows joists to completely dry out – reducing structural rot or mold
- Powder coated high strength steel or stainless steel

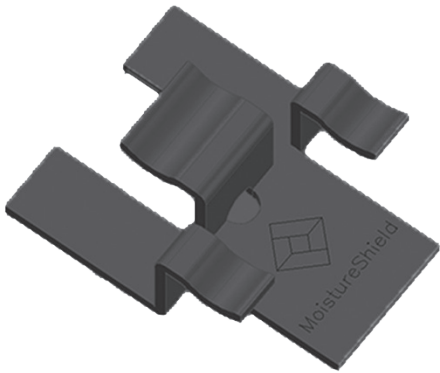

All clips also available in 304 grade stainless steel approved for coastal applications.

Standard Clip Packs include black coated carbon steel screws. Stainless steel kits include black coated 305 grade stainless steel screws.

NOTE: Traditional face screws can also be used.

Fastener Options that Work for You:

Complete System: Covers 50 Square Feet of Decking

- Includes 90 clips, 5 starter clips, 5 finish clips, and 100 screws
- Available in hand drive or pneumatic fasteners

Contractor Pack: Covers 250 Square Feet of Decking

- Includes 450 clips and 500 pneumatic nail screws
- (Starter and finisher clips are sold separately)

Starter Clip Pack: 25 Starter Clips with 25 Screws

- Starter clips are used to fasten the first deck board to the ledger board
- (Estimated need for 250 square foot deck)

Finisher Clip Pack: 25 Finish Clips with 25 Screws

- Finish clips fasten the last deck boards
- (Estimated need for 250 square foot deck)

Deck Clip Pack: 450 Deck Clips with 500 Hand Drive Screws

- Deck clips fasten the last deck boards to rim joists
- (Estimated need for 250 square foot deck)

Transition Clip Pack: 25 Transition Clips with 25 Screws

- Transition clips are used for picture frame decking and repair

For Installation: Pneumatic Gun: SENCO SHD150XP Hidden Deck Installation Tool



Railing Specifications









Composite



Aluminum

Lengths Available	6'	8'
Rail Specs	Magnum Rail Top and Bottom Actual Dimensions: 2.92" x 3.95" x 72"	Top Rail: 2.5" x 2.0625" Bottom Rail: 1.5" x 1.25" Offered in Level, Fixed Stair, Adjustable Stair Rail Kits
Baluster Specs	1.5" x 1.265" x 38" Square Profile Sold in Boxes of 14 Pieces	3/4" Round or Square Profile Available in 36" or 42" Rail Heights Kits include Exact Counts for Each Rail Length Available in Angled Cut for Fixed Stair Rail Kit
Post Specs	4" x 4" x 51" Square Profile Solid Post Actual Dimensions: 4.25" x 4.25" x 51"	3" x 3" Square Profile Post Available in 38" or 44" Heights
Cap/Collar Specs	Fits 4.25" x 4.25" Post Actual Dimensions: 5.5" x 5.5" OD	Fits 3" x 3" Post Included in Post Kit
Material Type	Wood-Plastic Composite	Aluminum
Available Colors	Bridle, Cape Cod Gray, Earthtone, Rustic Cedar, Seasoned Mahogany, and Walnut	Textured Black and White

Lighting Specifications

					
	Rail Strips	Bullet Lights	Stair Lights	Post Lights	Post Cap Lights
Dimensions	3/16" width 5/16" depth x 72" length Can be cut every 2" to shorten	1-1/8" width 1-1/2" depth	3-1/2" round 1-1/4" depth	Thin down: 1-3/4" width 1-1/4" height Hourglass: 1-3/16" width 3-1/8" height	Fits 3" post
Wiring	48" of 22/2-gauge wire on each	18" of 22-gauge wire on each	48" of 18/2-gauge wire on each	36" of 20-gauge wire on each	
Includes	Kit: (4) 72" strips, 12 wire connectors, 100' of wire, dimmer, 3 mounting screws, installation instructions, 3 amp transformer	Kit: (10) bullet lights, 27 wire connectors, 100' of wire, dimmer, 1 amp transformer, installation instructions	Single light with (2) mounting screws, installation instructions	Single light, installation instructions	Single light, installation instructions

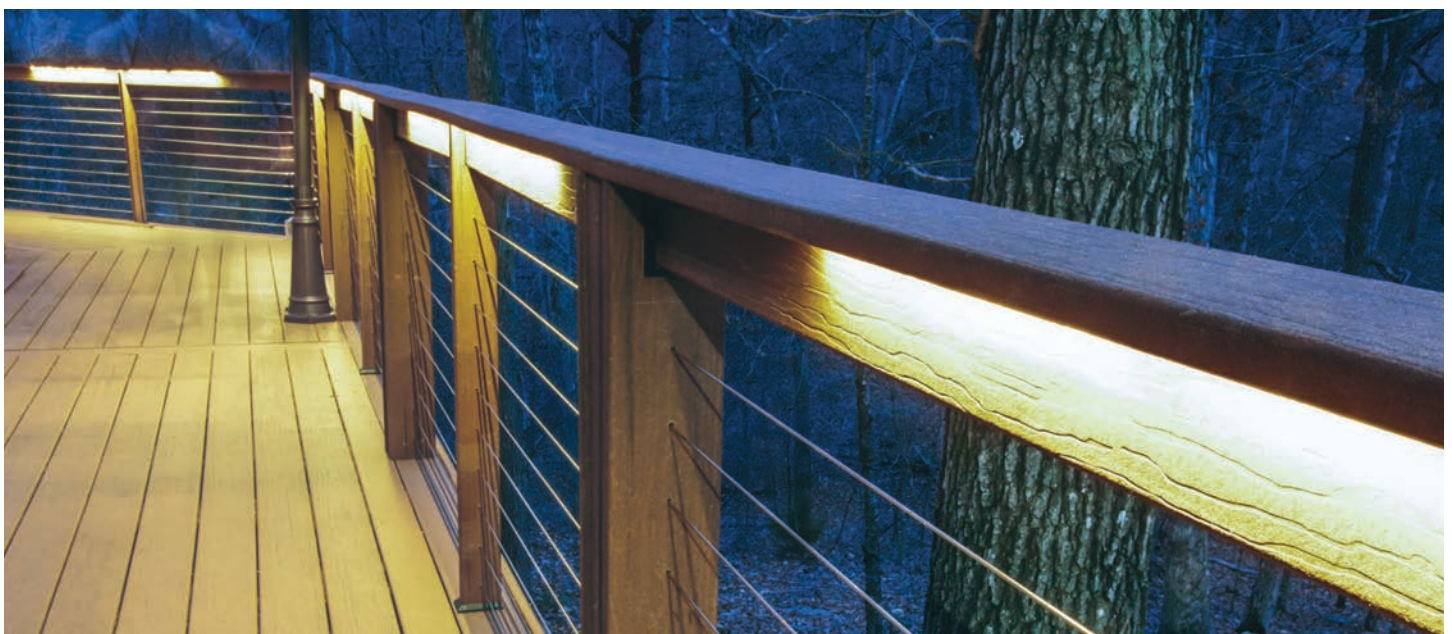



Discover More

Design and inspiration tools at [MoistureShield.com](https://www.moistureshield.com)

Deck Designer

Dream It. Design It. Build It. Enjoy It.

Dream up your perfect deck and then use our online deck designer to bring it to life! Upload an image of your home, build your new outdoor living space around it (adding deck furniture or even custom landscaping) and watch as your dreams become virtual reality.

Where to buy

Dealer Locator

Go online for a list of preferred MoistureShield retailers in your area.

Contractor Locator

Browse our list of certified deck builders in your area to find the best contractor for your project.

Contact MoistureShield Customer Service at 866.729.2378 to find out how to be listed as an Authorized MoistureShield Dealer or Contractor.



Warranty

25-Year Limited Fade & Stain	Infuse
30-Year Limited Fade & Stain	Elevate
50-Year Limited Fade & Stain	Vision



50-Year Structural Warranty



On All Decking

Make sure to register your deck online to ensure coverage.

[MoistureShield.com/Warranty](https://www.moistureshield.com/Warranty)

Installation

Visit our website for instructions and tips for installation.

[MoistureShield.com/Installation](https://www.moistureshield.com/Installation)

Care & Maintenance

MoistureShield decking is built with our proprietary Solid Core strength, and we've had zero structural failures in over 30 years.

Our decking is built to last. And, with basic care and maintenance, will keep looking like new for years to come.

Find detailed care and maintenance tips for your deck on our website.

[MoistureShield.com/Care](https://www.moistureshield.com/Care)



Specifications	Vision	Vision Marine Grade 2x	Infuse	Elevate	Vantage	Vantage Marine Grade 2x
1 x 6 (1.0" x 5.4") Actual Product Length (ft.)	12', 16', 20' Solid Edge & Grooved		12', 16', 20' Solid Edge & Grooved	20' Solid Edge 12', 16', 20' Grooved	12', 16', 20' Solid Edge & Grooved	
2 x 4 (1.5" x 3.5") Actual Product Length (ft.)					12', 16' Solid Edge	
2 x 6 (1.4" x 5.4") Actual Product Length (ft.)		Coming Soon				12', 16', 20' Solid Edge
2 x 8 (1.4" x 7.25") Actual Product Length (ft.)						12', 16', 20' Solid Edge Cape Cod Gray Only
Fascia Actual Product Length (ft.)	All Lines 0.67" x 11.25" x 12'					

