

## CABINETS • ARMOIRES • GABINETES

## DRAWERS • TIROIRS • CAJONES

### Knobs • Boutons • Perillas

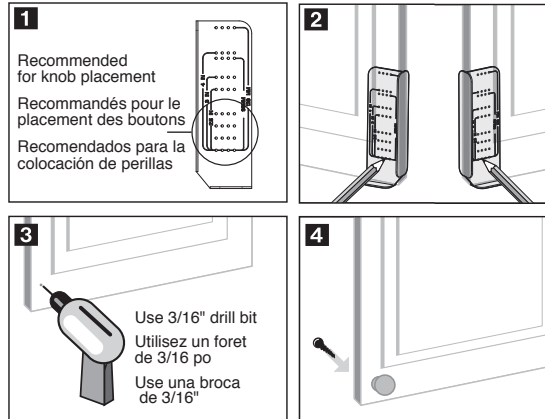

### Pulls • Poignées • Manijas

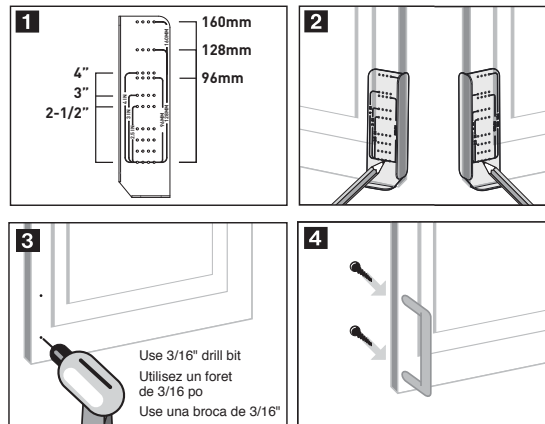

### Center Knob Bouton central Perilla centrada

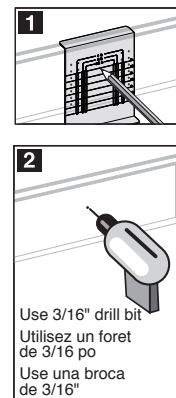

### Center Pull Poignée centrale Manija centrada

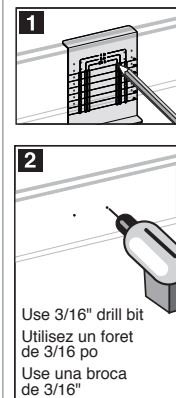

### Double Pull Poignée double Doble manija

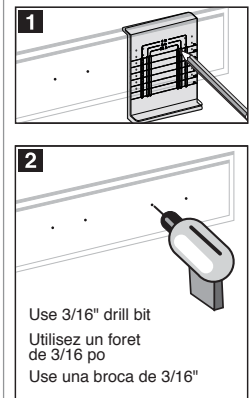

### 2-1/2" - 3" - 4" Pulls • Poignées • Manijas

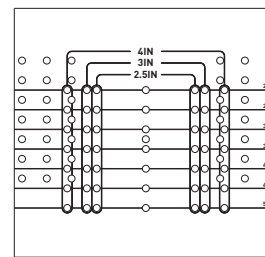

### 96mm - 128mm - 160mm Pulls • Poignées • Manijas

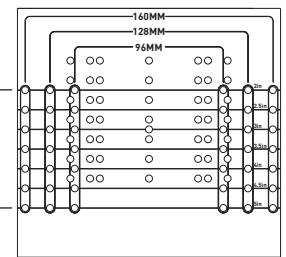

Drill your own holes in template for customized guides.

Percez vos propres trous dans le gabarit pour réaliser des guides sur mesure.

Perfore sus propios agujeros en la plantilla para obtener guías personalizadas.

AN6516C-CL-U



Wear Safety Goggles  
Portez des Lunettes de Sécurité  
Utilice Gafas Protectoras

Liberty Hardware Manufacturing Corporation  
140 Business Park Drive, Winston-Salem, NC 27107  
www.libertyhardware.com  
©2018 LHMC, A Masco Company  
Made in USA / Fabriqué en USA / Hecho en USA