



Certified to comply with ANSI A112.18.1M  
M965036 Rev. 1.6

### COLONY SOFT

#### SINGLE CONTROL KITCHEN PULL-DOWN FAUCET

Thank you for selecting American-Standard...  
the benchmark of fine quality for over 100 years.

To ensure that your installation proceeds smoothly—  
please read these instructions carefully before you begin.

#### RECOMMENDED TOOLS



Regular Screwdriver



Phillips Screwdriver



Adjustable Wrench

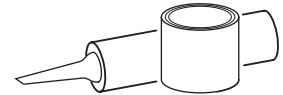

Plumbers' Putty or Caulking

## 1 INSTALL FAUCET WITH OR WITHOUT DECK ESCUTCHEON

### CAUTION

Turn off water at  
main supply.

- **(A) Installation with ESCUTCHEON (1).** Apply a bead of putty to bottom edge of ESCUTCHEON with PUTTY PLATE (1). Insert SUPPLY HOSES (2), SPRAY HOSE (9) and SHANK (3) through hole of ESCUTCHEON with PUTTY PLATE (1) and mounting surface. Follow mounting instructions below to secure faucet to mounting surface.
- **(B) Installation less ESCUTCHEON (1).** Discard ESCUTCHEON with PUTTY PLATE (1). Insert supply HOSES (2), SPRAY HOSE (9) and SHANK (3) through mounting hole and seat SPOUT BASE onto sink or mounting surface. Do not use putty.
- Insert HOSES (2) through RUBBER WASHER (4), BRASS WASHER (5), and threaded LOCKNUT (6).
- Assemble RUBBER WASHER (4), BRASS WASHER (5), and threaded LOCKNUT (6) onto SHANK (3) from underside of sink or mounting surface. Hand tighten LOCKNUT (6).
- Use a screwdriver to tighten SCREWS (8) on LOCKNUT (6). Work your way around LOCKNUT (6), tightening the screws slightly each time until all are snug to ensure even pressure.

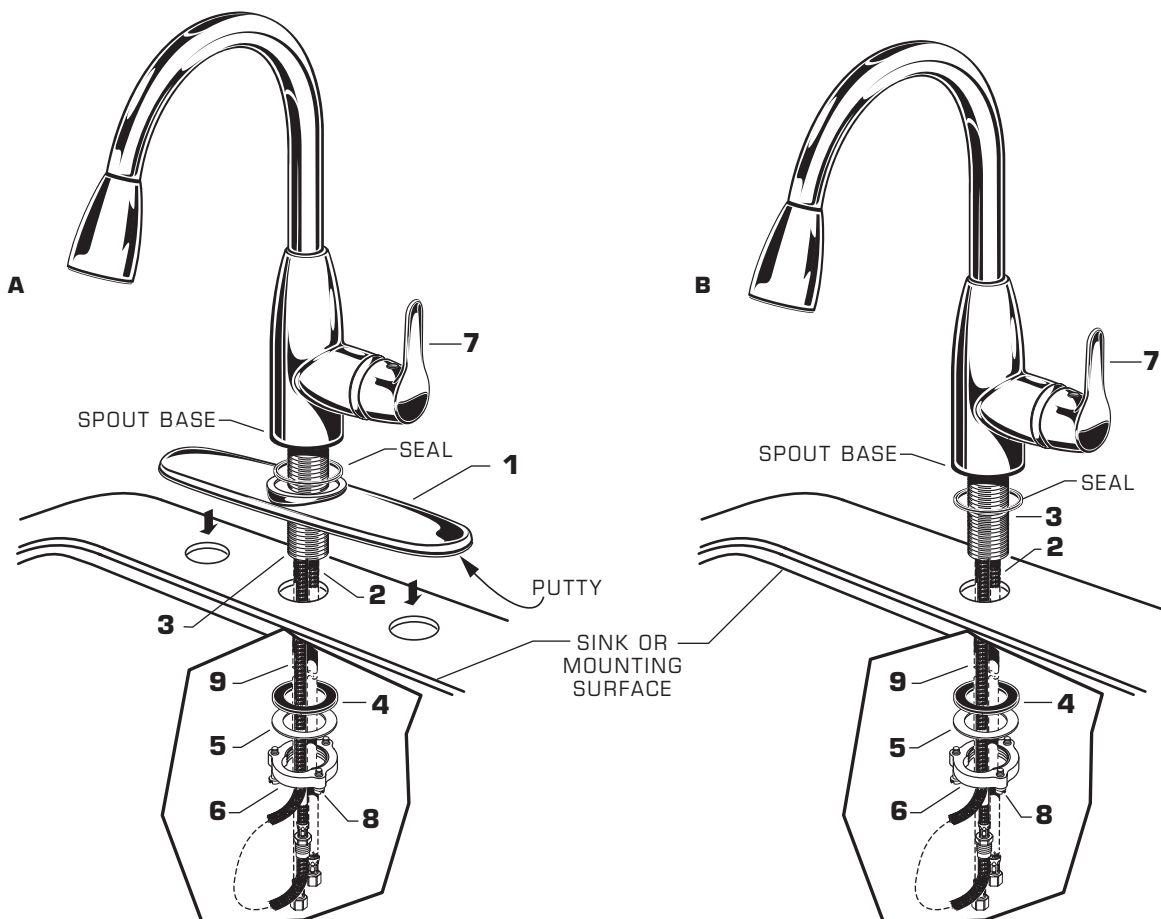

## 2 MAKE WATER SUPPLY CONNECTIONS

- Turn off hot and cold water supplies before beginning.
- Connect FLEXIBLE SUPPLIES (1, 2) directly to wall supplies. Connection on fitting supplies are 3/8" compression. Connect left supply (Marked with a Red Stripe) to Hot and right supply (Marked with Blue Stripe) to Cold wall supply. Use adjustable wrench to tighten connections. Do not over tighten.
- Faucet supplies are 21" long from faucet base.
- **Note:** If additional supply length is required, installer must purchase additional parts separately.
- **Important:** If SUPPLY HOSES (1, 2) are too long, loop as illustrated to avoid kinking.

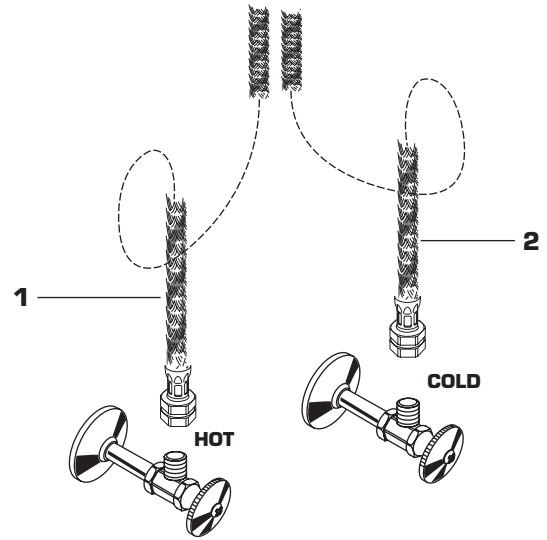

## 3 INSTALL WEIGHTS

- With HAND SPRAY (1) seated in SPOUT (2), install WEIGHT (3) onto HOSE (4) 18 inches from the underside of the sink deck and secure with SCREW (5).

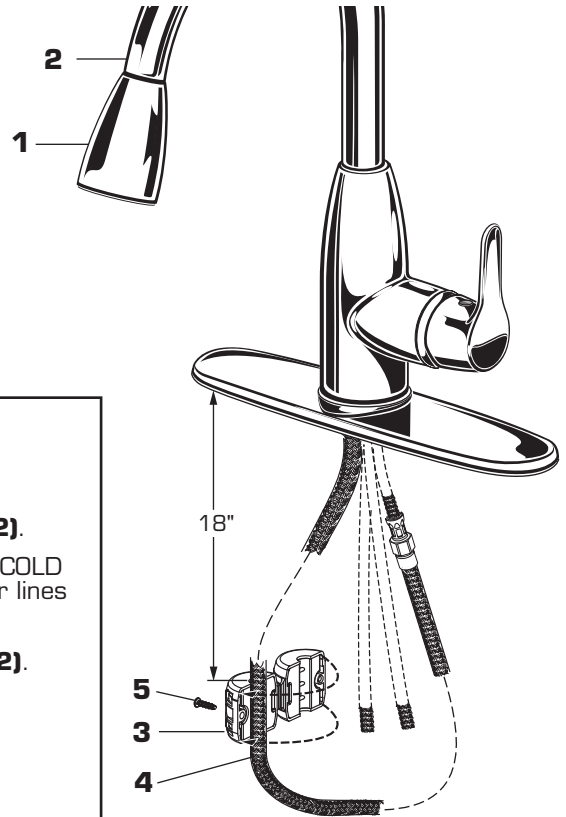

## 4 TEST INSTALLED FAUCET

- Move HANDLE (1) into "off" position.
- Turn on water supplies.
- Check connections for leaks. (See Section 5)
- With HANDLE (1) in "off" position, unthread SPRAY (3) from HOSE (2).
- Operate handle back to front, in COLD and HOT positions, to flush water lines thoroughly.
- Replace SPRAY (3) onto HOSE (2).

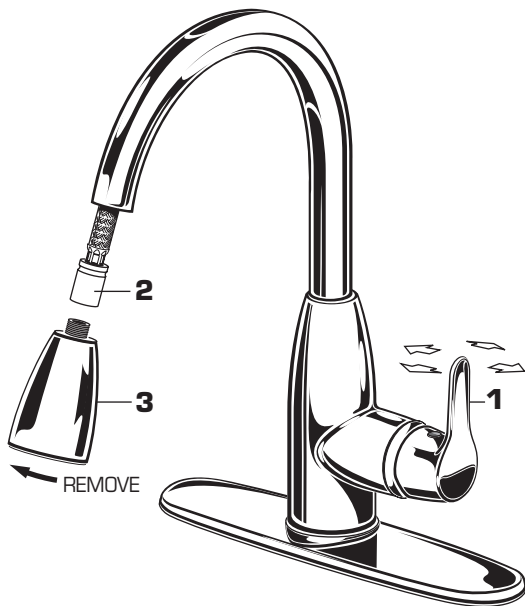

### SPRAY OPERATION

- With FAUCET on press TOGGLE BUTTON (4) on SPRAY (3) to switch from stream to spray.
- Press and hold PAUSE BUTTON (5) to temporarily stop flow from SPRAY (3). Release PAUSE BUTTON (5) to resume flow from SPRAY (3).

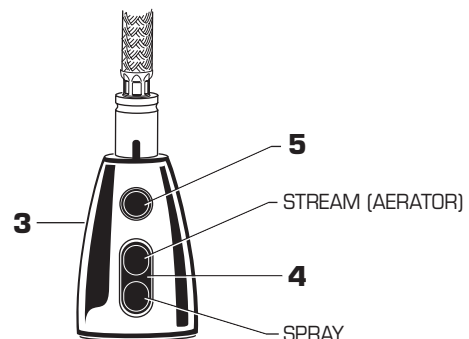

## 5 CHECK CONNECTIONS FOR LEAKS.

- Move HANDLE down into "off" position.
- Turn on water supplies and check connections for leaks. ➡
- Operate HANDLE (2) up and down, left and right to flush water lines thoroughly.
- Operate HAND SPRAY and check connections for leaks. ➡

CHECK CONNECTIONS FOR LEAKS ➡

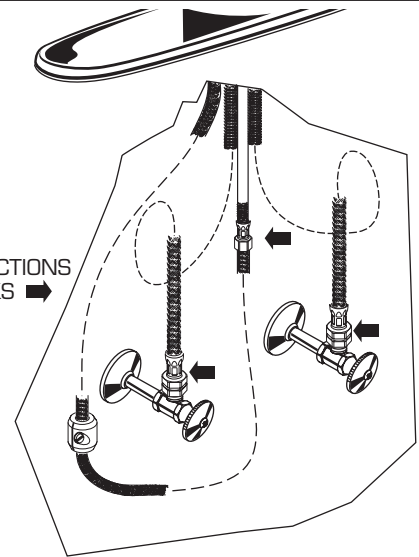

## 6 SERVICE

- If faucet drips, operate HANDLE several times from "off" to "on." Do not apply excessive force.
- **Clogged CARTRIDGE outlets or inlets may cause reduced flow.**  
To clean, first turn off water supply then:
  - Remove INDEX BUTTON (1), loosen HANDLE SCREW (2) and remove HANDLE (3).
  - Unthread the ESCUTCHEON CAP (4). Unthread three MOUNTING SCREWS (5).
  - Lift CARTRIDGE (6) off MANIFOLD (7) and remove CARTRIDGE SEALS (8).
  - Clean MANIFOLD (7), CARTRIDGE (6) ports and SEALS (8).
  - Place SEALS (8) into CARTRIDGE PORTS (6a).
  - Place CARTRIDGE (6) onto MANIFOLD (7) and tighten MOUNTING SCREWS (5) alternately.
  - Replace ESCUTCHEON CAP (4), HANDLE (3), tighten HANDLE SCREW (2) and install INDEX BUTTON (1).

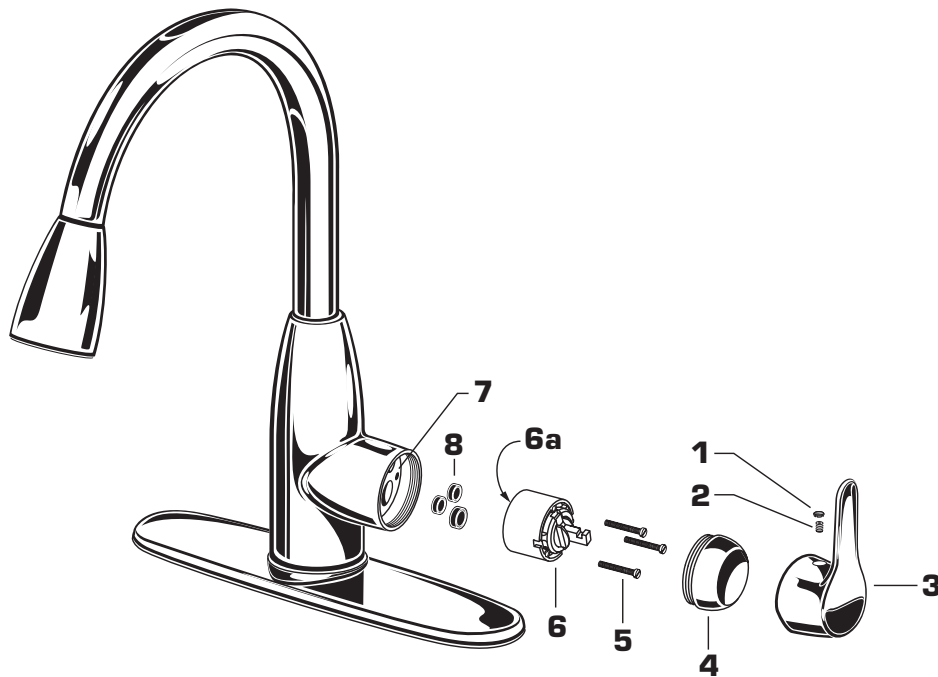

## 7 CARE:

**DO: SIMPLY RINSE THE PRODUCT CLEAN WITH CLEAR WATER. DRY WITH A SOFT COTTON FLANNEL CLOTH.**  
**DO NOT: DO NOT CLEAN THE PRODUCT WITH SOAPS, ACID, POLISH, ABRASIVES, HARSH CLEANERS, OR A CLOTH WITH A COARSE SURFACE.**

**COLONY SOFT**  
**SINGLE CONTROL KITCHEN**  
**PULL-DOWN FAUCET**  
 MODEL NUMBERS

**4175.300 Series**

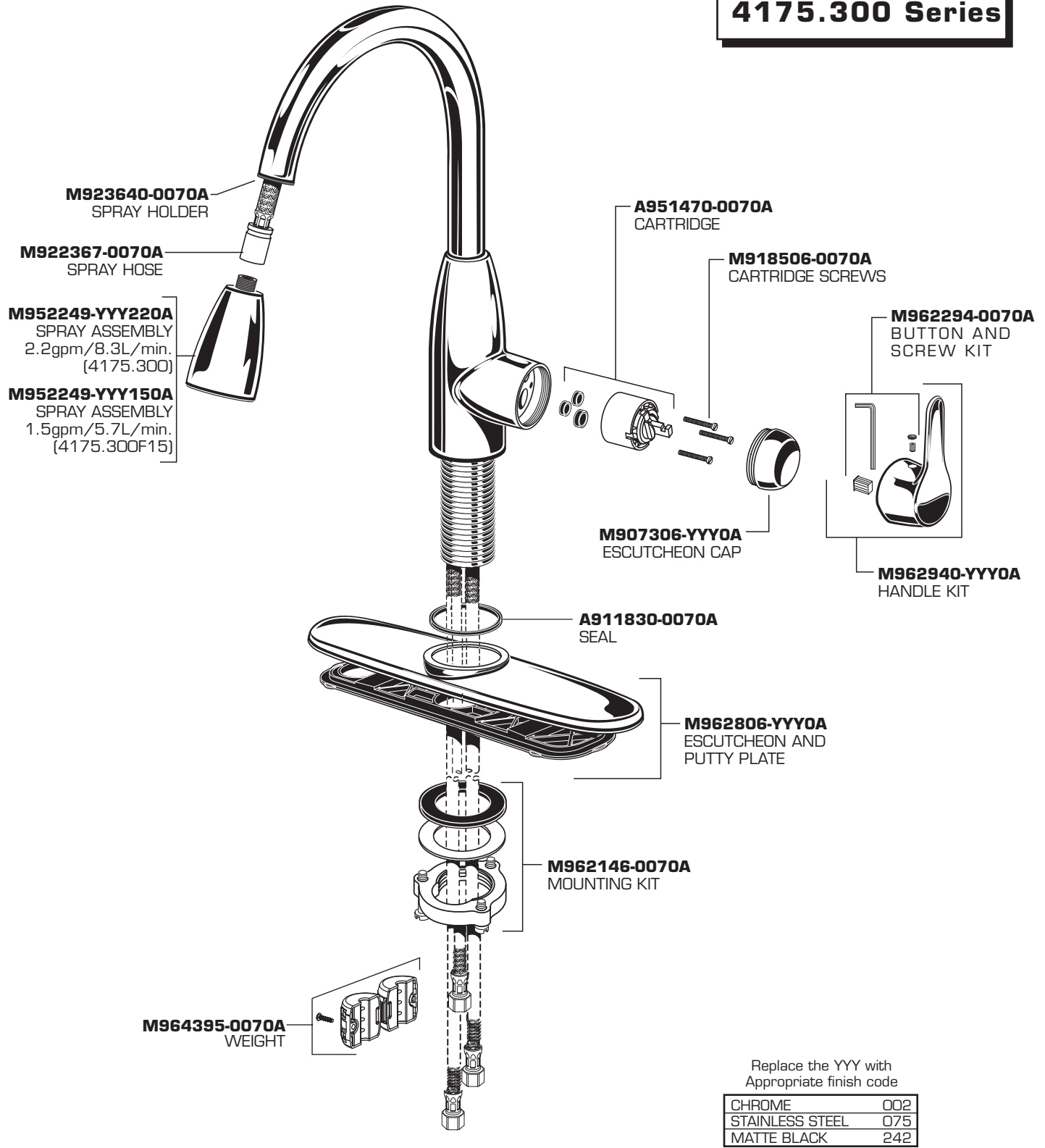

**HOT LINE FOR HELP**

For toll-free information and answers to your questions, call:  
 1-800-442-1902  
 Weekdays 8:00 a.m. to 6:00 p.m. EST  
 IN CANADA 1-800-387-0369 (TORONTO 1-905-306-1093)  
 Weekdays 8:00 a.m. to 7:00 p.m. EST  
 IN MEXICO 01-800-839-1200