

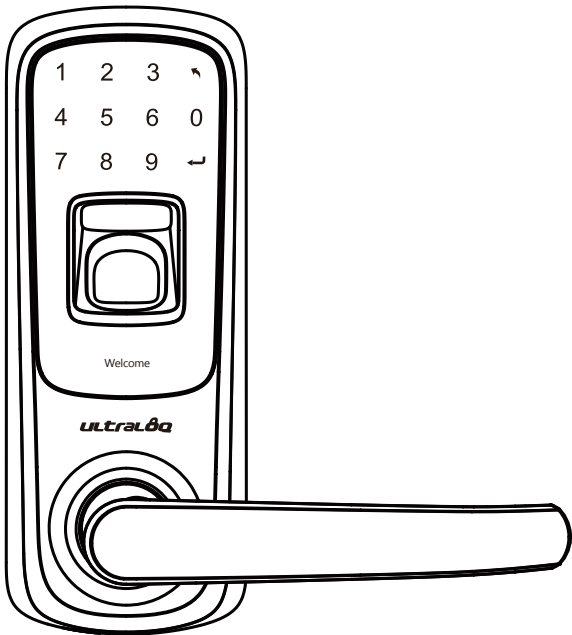

# Ultraloq UL3

Fingerprint and Touchscreen  
Smart Lock

User Guide (v1.3)



**ultralock**

## Operation Video

Please watch our easy step by step operation video before attempting to use your Ultraloq UL3 Fingerprint and Touchscreen Smart Lock.



[www.u-tec.com/support](http://www.u-tec.com/support)

If you have questions regarding the installation process please contact us at [customerservice@u-tec.com](mailto:customerservice@u-tec.com)

## Register Your Lock

To ensure the best warranty coverage and customer service, please register your product at

<http://store.u-tec.com/account/login>

\* This guide contains important information about your lock!

## Warranty Statements

See [www.u-tec.com](http://www.u-tec.com) for specific warranty details and limitations, or contact U-tec's Customer Service .

## Need Help?

---

For technical documents and more  
Please visit [www.u-tec.com/support](http://www.u-tec.com/support)  
Tel: 844-HEY-UTEC (844-439-8832)  
Email: [customerservice@u-tec.com](mailto:customerservice@u-tec.com)

# Lock Parts

## Exterior

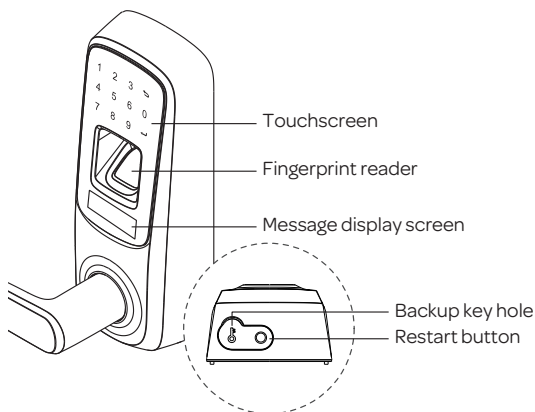

Backup Key Hole: Used to insert the key to unlock.

Restart Button: Used to jump start the lock if activation fails.

Fingerprint Reader: Used to press finger and unlock from the outside.

Touchscreen: Used to enter the code and unlock from outside.

0 - 9 Numbers    ↩ Return to previous    ↩ Confirm

## Interior

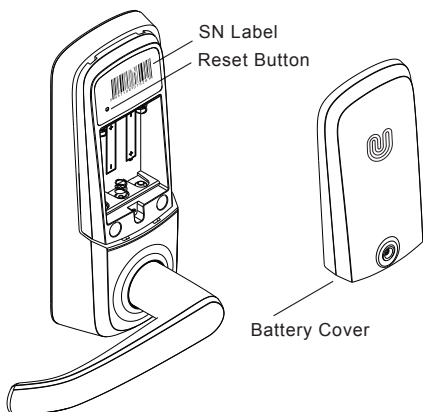

Reset Button: Used to reset the lock to factory default settings.

Battery Cover: Used to cover battery and product label. A Quick Guide is printed inside the battery cover.

## Lock Operation

### Clean the fingerprint reader and touchscreen

Use a microfiber cloth and wipe across the fingerprint reader surface and the touch screen.

### Lock Activation

Press finger on fingerprint reader or touch lock with the back of hand or fingers.

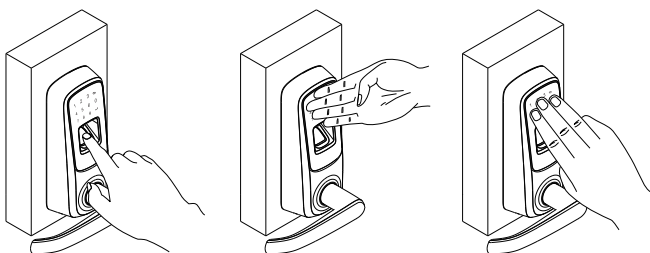

The lock will turn off again after 20 seconds if there are no other inputs.

### Open door from outside with user PIN code

1. Touch lock with back of hand or fingers to activate the lock.
2. Input user PIN code to unlock.
3. Rotate handle and open the door.

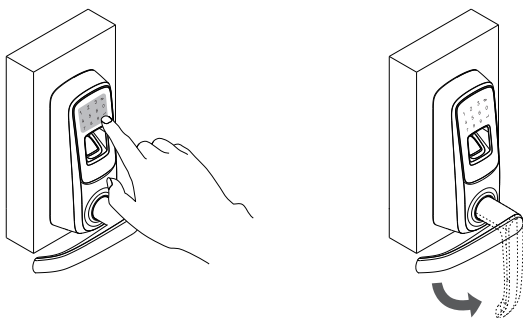

## Open door from outside with fingerprint

1. Press finger on the fingerprint reader to activate and unlock.
2. Rotate the handle and open the door.

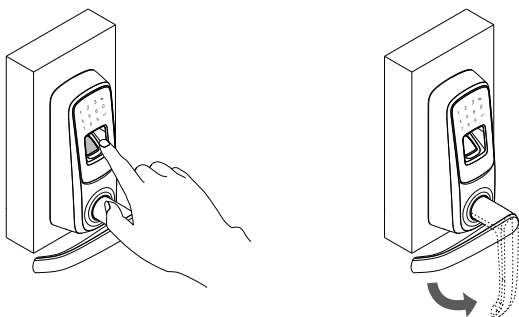

## Open door from inside

1. Rotate the handle and open the door.

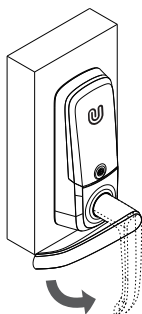

## Replace battery

When you activate the lock and see the message “Low battery”, you should replace the batteries.

Use 3 high-quality alkaline AA batteries for replacement.

## Emergency Key Override

Emergency Key Override can be used when the battery is dead, or when no valid User Code is known.

The key hole is on the bottom of the lock. Insert the key and rotate to unlock, just like any lock. Take good care of your emergency keys.

## Vague Code

Ultraloq UL3 supports up to 16-digit Vague Code. Just enter any 16-digit code, as long as a correct code is included in what you entered, you can open the door.

### Example User Code:123456

#### Vague Code Method

1: 123456XXXXXXXX

2: XXXXXXX123456

3: XXX123456XXX

#### Place Finger

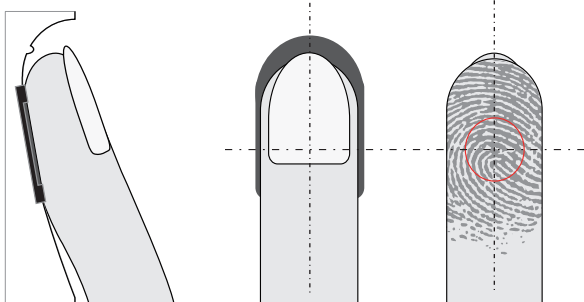

1. Place a finger flat on the sensor's surface.
2. Place a finger in the center of the sensor.

# Lock Programming

## Factory Defaults

Factory default setting is that any fingerprint or PIN code can open the door.

## Register Admin and User

Admin account must be created first before any other programming. Then use the Admin account to add or delete the other accounts.

## User PIN code

User PIN code can be 4 to 8 numbers.



## User ID number

User ID can be 1 to 8 numbers.

## Limit the number of users on lock

You can register up to 95 users with fingerprint and PIN code.

## Basic programming steps

1. Activate lock. Press and hold  for 3 seconds to into menu.
2. Input number to select functions:
  - 1** to add User
  - 2** to delete User
  - 7** to add Admin
  - 8** to delete Admin
3. Press  and follow the displayed messages to setup.

## Reset the lock

Remove the battery cover. The reset button is under the serial number label. Find a small paper clip and stick one end into the reset button hole while the lock is active. Press and hold the reset button for 3 seconds until a beep is audible. All user info will be deleted.

# 1

## Add Admin First

Admin account must be created first prior to any other programming.

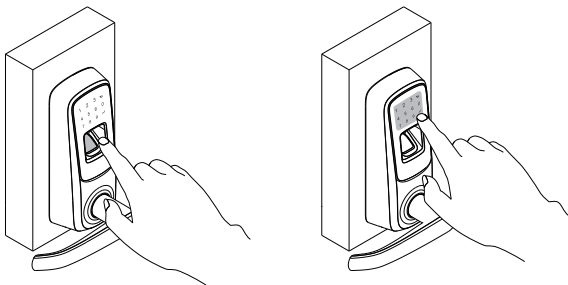

Activate Lock

No User

Press and hold  for 3 sec

Add admin

Press 

Finger or code

Press finger or input a PIN code 

Enter again

Press finger or input a PIN code 

Success



## Add User

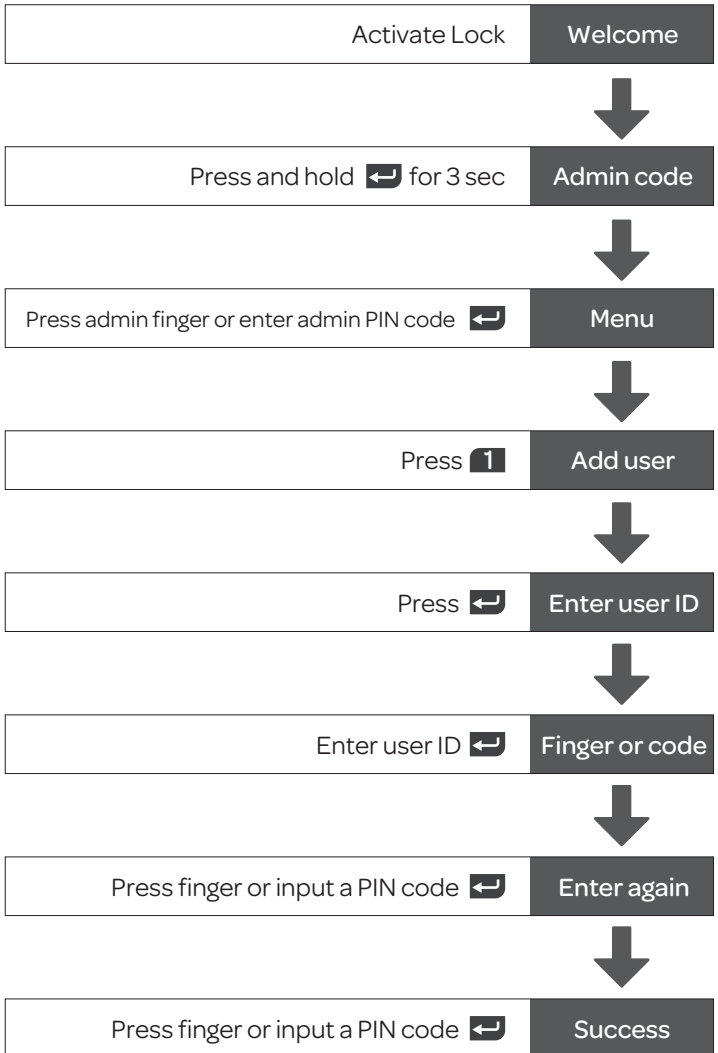

# 3

## Delete User

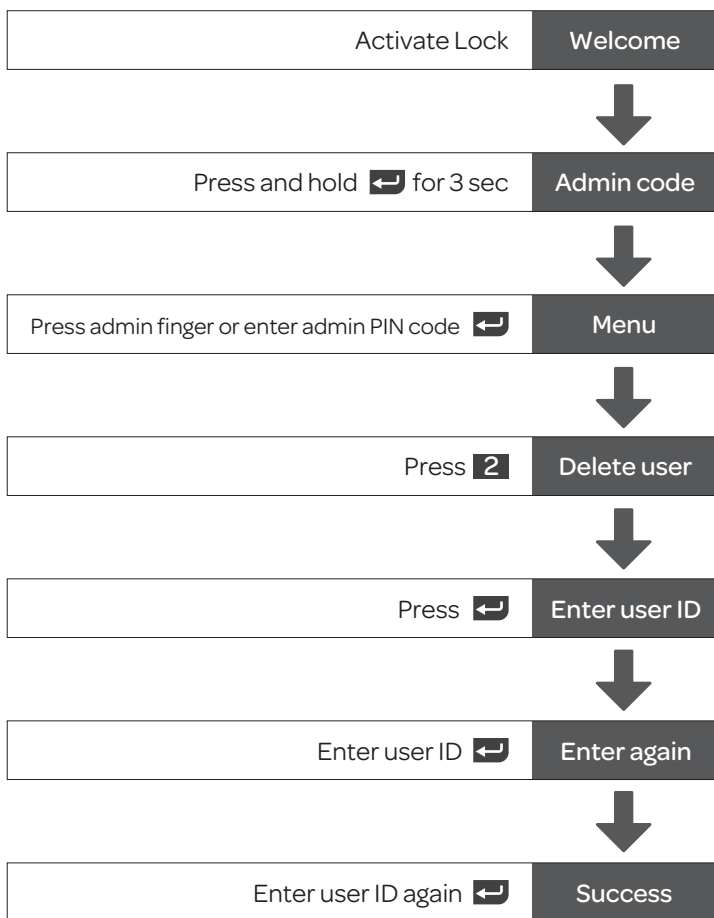

## Add Admin

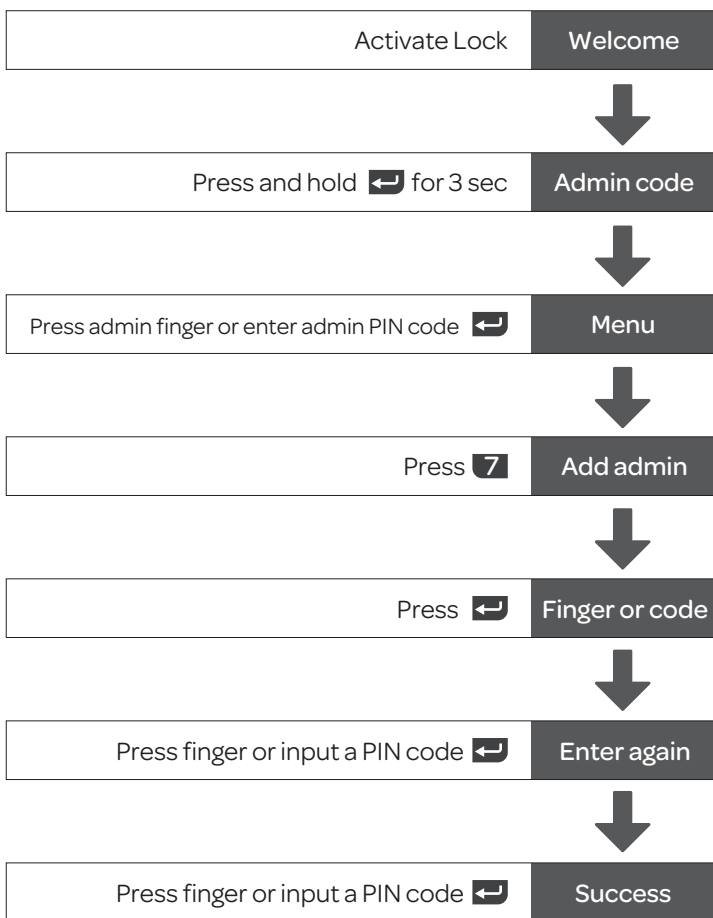

Note: It is recommended to register several Admin fingerprints and PIN codes.

# 5

## Delete Admin

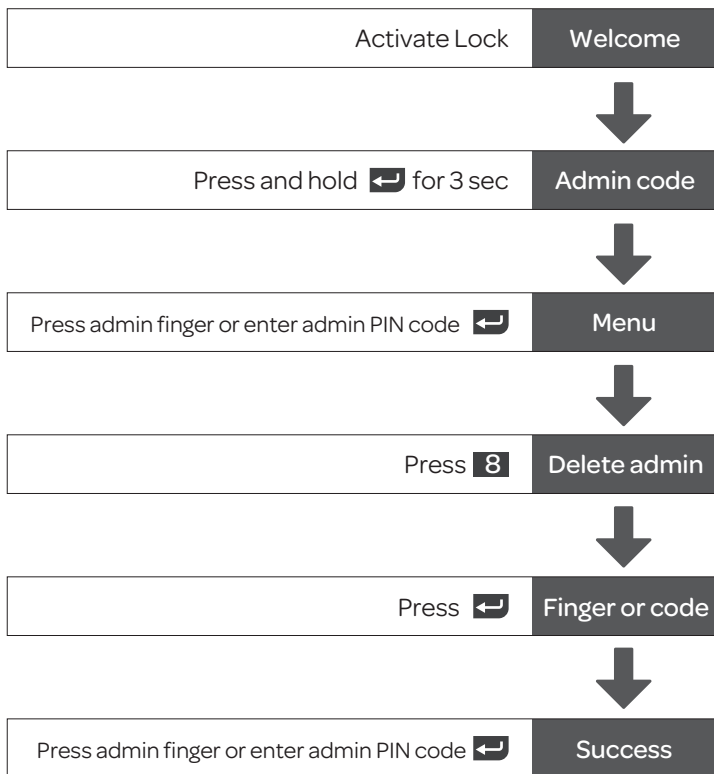









***ULTRALOQ***

U-tec and Ultraloq brands and products are trademarked  
and protected under law in the United States.  
Unauthorized use is prohibited.

Ultraloq is sub-brand of U-tec Group Inc.

2016 © U-tec Group Inc. All Rights Reserved.