

# WarmWire®

## Installation Manual

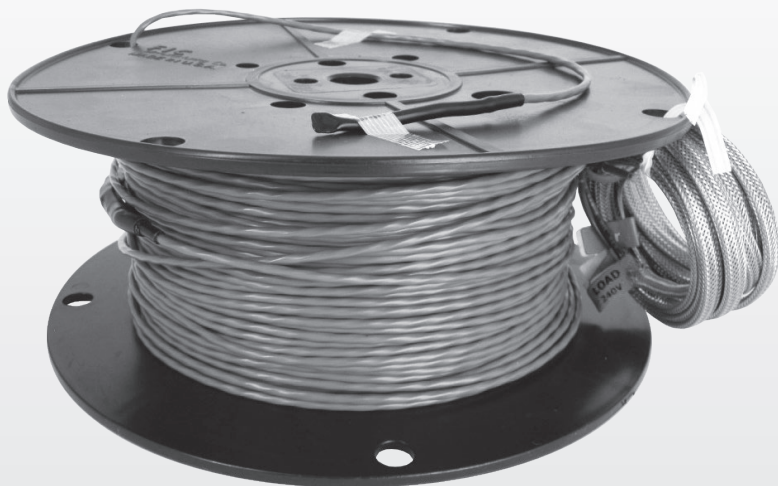

Series  
WB & WR



### ⚠ WARNING

Please be aware local codes may require this product and/or the thermostatic control to be installed or connected by an electrician.

## ⚠ WARNING



**THINK  
SAFETY  
FIRST**

Read this Manual BEFORE using this equipment.

Failure to read and follow all safety and use information can result in death, serious personal injury, property damage, or damage to the equipment.

Keep this Manual for future reference.

*WarmWire® is a simple, economical way to warm any floor, and provide years of lasting comfort. This instruction manual provides complete details, suggestions, and safety precautions for installing this floor-warming system. Fasten the cables to the floor. Then, depending on the floor coverings to be used, put down a layer of thin-set, thick-set, or self-leveling mortar on top of the cables. Finally, install the floor coverings. It's that simple!*

## Specifications for WarmWire:

WarmWire is a complete heating cable consisting of a series resistance heating cable and a power lead for connection to the electric power supply. The heating cable cannot be cut to fit.

**Voltages:** 120 VAC, 240 VAC, 1-phase

**Watts:** 3 W/linear foot. Approximately 10.3 W/ft<sup>2</sup> (34 Btu/h/ft<sup>2</sup>) for 3.5" spacing, 12 W/ft<sup>2</sup> (41 Btu/h/ft<sup>2</sup>) for 3" spacing. and 14.4 W/ft<sup>2</sup> (51 Btu/h/ft<sup>2</sup>) for 2.5" spacing. (See Table 2)

2.5" spacing may only be used under masonry surfaces with a maximum floor covering R-value of R-1.5 as indicated in this manual. 3" or 3.5" spacing may be used under floor covering types with a maximum R-value of R-2.5.

**Maximum circuit load:** 15 amps

**Maximum circuit overload protection:** 20 amp breaker

**GFCI:** (Ground Fault Circuit Interrupter) required for each circuit (included in the SunStat control)

**Listing:** UL Listed for U.S. and Canada under UL 1673 and CAN/CSA C22.2 No. 130.2-93, File No. E185866

**Application:** Indoor floor heating only (-X on the nameplate label indicates CUL Listing for this application). Suitable for installation in a shower area (see pg 18 for restrictions) (-W on the nameplate label indicates CUL Listing for Wet Location in Canada per Canadian Electrical Code, Part I (CEC)).

Embedded in cement based mortar only, polymer-modified preferred (see Appendix 1).

**Minimum bend radius:** 1 inch

**Maximum exposure temperature:**  
(continuous and storage) 194°F (90°C)

**Minimum installation temperature:** 50°F (10°C)

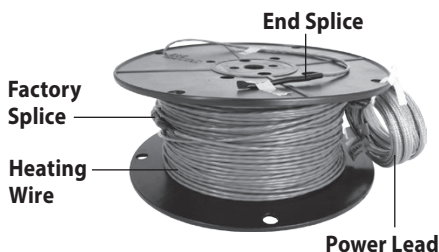

## ⚠ WARNING

Installation must be performed by qualified persons, in accordance with local codes, ANSI/NFPA 70 (NEC Article 424) and CEC Part 1 Section 62 where applicable. Prior to installation, please consult the local codes in order to understand what is acceptable. To the extent this information is not consistent with local codes, the local codes should be followed. However, electrical wiring is required from a circuit breaker or other electrical circuit to the control. It is recommended that an electrician perform these installation steps. Please be aware local codes may require this product and/or the control to be installed by an electrician.

## Expected floor temperature

Heating performance is never guaranteed. The floor temperature attainable is dependent on how well the floor is insulated, the temperature of the floor before start up, and the overall thermal drain of the floor mass. Insulation is required for best performance. Refer to Phase 9 for important design considerations.

### These are the three most common installations:

- 1. Wood framing:** With the cable installed on a well-insulated wood subfloor, and thin-set mortar and tile on top, most floors can be heated up to 20°F warmer than they would otherwise be.
- 2. Insulated concrete slab:** With the cables installed on an insulated concrete slab, and thin-set mortar and tile on top, most floors can be heated up to perhaps 15°F warmer than they would otherwise be.
- 3. Uninsulated concrete slab:** With the cables installed on an uninsulated concrete slab, and thin-set mortar and tile on top, most floors can be heated up to perhaps 10°–15°F warmer than they would otherwise be.

Please consult a designer or the factory if questions remain about the surface temperature that can be expected from the cables in any particular construction. Please see “Phase 10: Install Insulation” on page 22.

---

## Table of Contents

Important Safety Information.....	3	7 - Finish Wiring .....	20
1 - Preparations .....	5	8 - Control Installation .....	21
2 - Electrical Rough-in .....	9	9 - Install the Floor Coverings.....	21
3 - HeatMatrix Cable Install .....	11	10 - Install Insulation .....	22
4 - CableStrap / Cable Install .....	14	Appendices .....	23
5 - Shower Area Installation.....	18	Troubleshooting .....	33
6 - Final Steps .....	19	Warranty.....	35

## Important Safety Information



This is a safety-alert symbol. The safety alert symbol is shown alone or used with a signal word (DANGER, WARNING, or CAUTION), a pictorial and/or a safety message to identify hazards.

When you see this symbol alone or with a signal word on your equipment or in this Manual, be alert to the potential for death or serious personal injury.



This pictorial alerts you to electricity, electrocution, and shock hazards.

### WARNING

This symbol identifies hazards which, if not avoided, could result in death or serious injury.

### CAUTION

This symbol identifies hazards which, if not avoided, could result in minor or moderate injury.

### NOTICE

This symbol identifies practices, actions, or failure to act which could result in property damage or damage to the equipment.

**Table 1**

**⚠ WARNING**



As with any electrical product, care should be taken to guard against the potential risk of fire, electric shock, and injury to persons. The following cautions must be observed:

**NEVER** install WarmWire under carpet, wood, vinyl, or other non-masonry flooring without embedding it in thin-set, thick-set, or self-leveling mortar.

**NEVER** install WarmWire in adhesives or glues intended for vinyl tile or other laminate flooring, or in pre-mix mortars. It must be embedded in cement based mortar.

**NEVER** cut the heating wire. Doing so will cause dangerous overheating and will void the warranty. The power lead may be cut shorter if necessary, but never remove completely from the heating wire.

**NEVER** bang a trowel or other tool on the heating wire. Be careful not to nick, cut, or pinch the wire causing it to be damaged.

**NEVER** use nails, staples, or similar to fasten the heating wire to the floor.

**NEVER** attempt to repair a damaged heating wire, splice, or power lead using unauthorized parts. Use only factory authorized repair parts and methods.

**NEVER** splice one heating wire to another heating wire to make it longer. Multiple WarmWire power leads must be connected in parallel in a junction box or to the thermostat.

**NEVER** install one wire on top of another or overlap the heating wire on itself. This will cause dangerous overheating.

**NEVER** forget to install the floor sensor included with the thermostat.

**NEVER** install WarmWire in any walls, or over walls or partitions that extend to the ceiling.

**NEVER** install wires under cabinets or other built-ins having no floor clearance, or in small closets. Excessive heat will build up in these confined spaces, and the wire can be damaged by fasteners (nails, screws, etc.) used to install built-ins.

**NEVER** remove the nameplate label from the power leads. Make sure it is viewable for inspection later.

**NEVER** extend the heating wire beyond the room or area in which it originates.

**NEVER** allow a power lead or sensor wire to cross over or under a heating cable. Damage could result.

**NEVER** put the system into full operation until the tile or flooring installer verifies all cement materials are fully cured (typically two to four weeks).

**NEVER** energize WarmWire while it is on the spool. Damage will result.

**ALWAYS** completely embed the heating wire and factory splices in the floor mortar.

**ALWAYS** maintain a minimum of 2" spacing between heating wires.

**ALWAYS** pay close attention to voltage and amperage requirements of the breaker, the thermostat, and the WarmWire. For instance, do not supply 240 VAC power to 120 VAC WarmWire as damage will result.



**NEVER** bang a trowel or other tool on the heating cable.



**ALWAYS** completely embed the factory splice and all heating wire in mortar. **NEVER** bend the splice or place any part of it in the wall or through the floor.

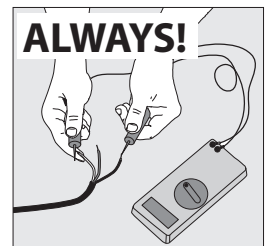

**ALWAYS** test the wire before and after installation.

**ALWAYS** make sure all electrical work is done by qualified persons in accordance with local building and electrical codes, Section 62 of the Canadian Electrical Code (CEC) Part I, and the National Electrical Code (NEC), especially Article 424.

**ALWAYS** use copper only as supply conductors to the thermostat. Do not use aluminum.

**ALWAYS** seek help if a problem arises. If ever in doubt about the correct installation procedure to follow, or if the product appears to be damaged, the factory must be called before proceeding with the installation.

### **⚠ WARNING**

Installation must be performed by qualified personnel, in accordance with local codes and standards. A licensed electrician is recommended.

## **Phase 1 - Preparations**

Before installing WarmWire, make sure to fully inspect the products and carefully plan the site. All electrical components selected must be certified for use in your location.

## **Items Needed**

### **Materials:**

- WarmWire® system
- CableStrap™ or HeatMatrix™ crack-isolation membrane (purchased separately or as part of a kit from SunTouch).
- SunStat® Thermostat with floor sensor (SunStat thermostats are UL Listed)
- SunStat Relay control if required (SunStat relays are UL Listed)
- Control electrical box (UL Listed, extra deep, see control instructions for size and type required)
- Junction electrical box (if required, must be UL Listed and proper size)
- Wire nuts (if required, must be UL Listed and proper size)
- Flexible or rigid conduit (if required, see Step 2.4, must be UL Listed and proper size)
- 12-gauge or 14-gauge electrical wiring cable (UL Listed, see Step 2.1)
- Nail plate

### **Tools:**

- Digital multi-meter (for ohms testing; must read up to 20,000 ohms ( $\Omega$ ) to measure sensor)
- Drill with 1/2" and 3/4" bits
- Hammer and chisel
- Hot glue gun and hot glue (craft grade)
- Wire strippers
- Phillips screwdriver
- Fish tape
- Hole saw
- Floor covering installation tools



**Floor sensor is included in the thermostat packaging. This must be installed in the floor with the cable.**

**Table 2 - Cable sizes (all Models with suffix WB & WR)**

Please check the product label for exact ratings. This table is for reference only.

The coverage areas below are for CableStrap or HeatMatrix installation. Contact the factory if using alternate attachment materials that may require different wire spacing. The area coverages shown are approximate and may vary due to installation pattern variations. Also, the heating cable is designed to operate 3 W/linear foot. Values for heat output per square foot may vary depending on installation variations.

**120 VAC**

Model Number	Total Sq. ft. 2.5" Spacing 14.4 watts/ft <sup>2</sup>	Total Sq. ft. 3" Spacing 12 watts/ft <sup>2</sup>	Total Sq. ft. 3.5" Spacing 10.3 watts/ft <sup>2</sup>	Wire Length (ft.)	Amp Draw	Resistance (ohms)
120010	8	10	12	39	1.0	108 - 134
120015	13	15	18	59	1.5	72 - 89
120020	17	20	24	78	2.0	53 - 66
120025	21	25	30	98	2.5	42 - 52
120030	25	30	36	117	3.0	33 - 42
120035	29	35	42	137	3.5	29 - 37
120040	34	40	48	157	4.0	25 - 32
120045	38	45	54	176	4.5	22 - 28
120050	42	50	60	196	5.0	20 - 26
120060	51	60	72	235	6.0	16 - 21
120070	59	70	84	274	7.0	14 - 19
120080	67	80	96	313	8.0	12 - 16
120090	76	90	108	352	9.0	11 - 14
120100	84	100	120	391	10.0	10 - 13

**240 VAC**

Model Number	Total Sq. ft. 2.5" Spacing 14.4 watts/ft <sup>2</sup>	Total Sq. ft. 3" Spacing 12 watts/ft <sup>2</sup>	Total Sq. ft. 3.5" Spacing 10.3 watts/ft <sup>2</sup>	Wire Length (ft.)	Amp Draw	Resistance (ohms)
240020	17	20	24	78	1.0	217 - 267
240030	25	30	36	117	1.5	143 - 176
240040	34	40	48	157	2.0	107 - 132
240050	42	50	60	196	2.5	84 - 104
240060	51	60	72	235	3.0	67 - 83
240070	59	70	84	274	3.5	59 - 73
240080	67	80	96	313	4.0	50 - 63
240090	76	90	108	352	4.5	45 - 56
240100	84	100	120	391	5.0	40 - 50
240120	101	120	144	470	6.0	33 - 42
240140	118	140	168	548	7.0	29 - 37
240160	135	160	192	626	8.0	24 - 31
240180	151	180	216	704	9.0	22 - 28
240200	168	200	240	783	10.0	20 - 26

**NOTICE**

It is important to select the proper size cable for the given area. WarmWire cannot be cut shorter in order to fit a given area. Doing so will damage the heating wire and prevent the system from working.

## ⚠ WARNING



To prevent the risk of personal injury and/or death, make sure power is not applied to the product until it is fully installed and ready for final testing. All work must be done with power turned off to the circuit being worked on.

### STEP 1.1

Remove the WarmWire, SunStat thermostat, and SunStat sensor from their packages. Inspect them for any visible damage. Verify everything is the correct size and type according to the plan and the order. Do not attempt to install a damaged product.

### STEP 1.2

Record the product information. There is a factory-applied nameplate label on the power leads. Do not remove this label. Record the cable serial number, model number, voltage, and cable resistance range in the Cable and Sensor Resistance Log (Table 4). If installing more than one cable, do this for each of them.

### STEP 1.3

Use a digital multi-meter set to the 200Ω or 2000Ω (2kΩ) range to measure the resistance between the conductors of the cable power leads. Record these resistances in Table 4 under “Out of the box before installation”. The resistance should measure within the resistance range on the nameplate label. If it is a little high or low, it may be due to air temperatures or meter calibration. Consult the factory if in doubt.

Measure the resistance between either of the white or black leads and ground lead. This measurement should be “open”, usually indicated by an “OL” or a “1”. This is the same as displayed when the test leads are not touching anything.

If there is any change in the reading, record this information and contact the factory before continuing. This could indicate damage, test lead problems, or a number of other issues. Try “pinning” the test leads to the cable lead wires against a hard non-metal surface if the readings continue to fluctuate.

Change the meter to the 20,000 ohms (20 kΩ) range. Measure between the lead wires of the SunStat sensor. This resistance varies according to the temperature sensed. Table 3 provides approximate resistance-to-temperature values for reference.

**Table 3 - Floor Sensor Resistance Values**

Temperature	Typical Values
55°F (13°C)	17,000 ohms
65°F (18°C)	13,000 ohms
75°F (24°C)	10,000 ohms
85°F (29°C)	8,000 ohms

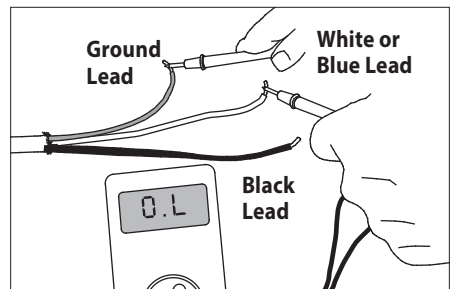
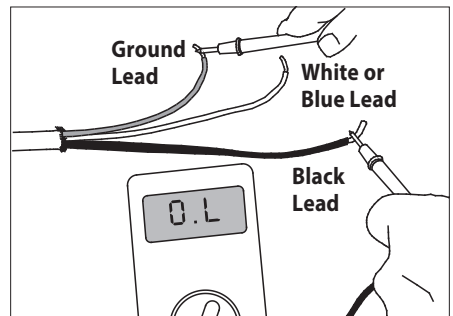
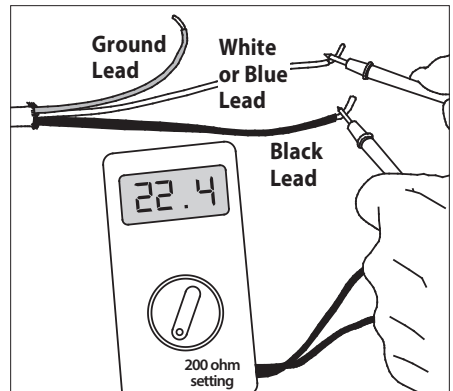

**Table 4 - Cable and Sensor Resistance Log**

	Cable 1	Cable 2	Cable 3
Cable serial number			
Cable model			
Cable voltage			
Factory cable resistance range			
<b>OUT OF THE BOX BEFORE INSTALLATION (OHMS)</b>			
Cable black to white (black to blue for 240VAC)			
Cable black to ground			
Cable white to ground (blue to ground for 240VAC)			
Sensor wire			
<b>AFTER CABLE AND SENSOR ARE FASTENED TO FLOOR (OHMS)</b>			
Cable black to white (black to blue for 240VAC)			
Cable black to ground			
Cable white to ground (blue to ground for 240VAC)			
Sensor wire			
<b>AFTER FLOOR COVERINGS ARE INSTALLED (OHMS)</b>			
Cable black to white (black to blue for 240VAC)			
Cable black to ground			
Cable white to ground (blue to ground for 240VAC)			
Sensor wire			

**Retain this log to retain the warranty! Do not discard!**

**INSTALLATION NOTES**



## Phase 2 - Electrical Rough-in

### WARNING

To prevent the risk of personal injury and/or death, make sure power is not applied to the product until it is fully installed and ready for final testing. All work must be done with power turned off to the circuit being worked on.

#### STEP 2.1:

##### Circuit Breaker (Overcurrent Protection)

WarmWire must be protected against overload by a circuit breaker. GFCI type (ground fault circuit interrupter) or AFCI type (arc-fault circuit interrupter) breakers may be used if desired, but are not necessary when using SunStat controls with integral GFCI.

The rating of the breaker (**see Table 5**) is determined by the amp draw of the heating cables. Add the amp ratings of all cables to be connected to the SunStat control (see Table 2 or the Nameplate Label on the cable). If the total is less than 12 amps, use a 15 or 20 Amp breaker (preference is 15 A). If the total is between 12 and 15 amps, use a 20 Amp breaker. If the total is over 15 A, another circuit will be required with its own breaker and SunStat control.

It may be possible to tap into an existing circuit as long as there is adequate capacity for the cables(s) and any additional appliance, such as a hair dryer or vacuum cleaner. Avoid circuits which have lighting, motors, exhaust fans, or hot tub pumps due to possible interference.

**Table 5**

Circuit Breakers and Supply Wire					
Cable(s)		Supply Wire		Breaker	
VAC	total amps	(AWG)*	qty	type**	rating
120	up to 12 amps	14	1	SP	15 or 20 A
120	up to 15 amps	12	1	SP	20 A
240	up to 12 amps	14	1	DP	15 or 20 A
240	up to 15 amps	12	1	DP	20 A

\* Recommended only. Follow local codes for wire gauge size.

\*\* SP= single-pole, DP=double-pole

#### STEP 2.2:

##### Install Electrical Boxes

###### **SunStat® Thermostat:**

Install an extra-deep electrical box for the SunStat Thermostat. Follow the instructions included with the thermostat for complete information on location and wiring.

###### **SunStat Relay:**

Install an extra-deep electrical box for any SunStat Relay(s). The SunStat Relay is used when more than 15 amps must be controlled by one SunStat Thermostat. Follow the instructions included with the SunStat Relay for complete information on location and wiring.

##### Junction Boxes:

If a cable is to be located so its power lead is not long enough to reach the SunStat thermostat or SunStat Relay directly, a junction box must be installed. Do not attempt to make a connection to other wiring without a junction box. Use a standard junction box with a cover, mounting it below the subfloor, in the attic, in the wall, or in another location easily accessible after all coverings are complete. If the SunStat sensor wire is not long enough to reach the SunStat thermostat directly, it may be extended. A junction box may be required by local code to make this connection. Follow the installation instructions included with the SunStat for details.

For construction with an existing wall or where the wall is covered, cut the necessary openings to mount the electrical boxes listed above. Wait to install the boxes until all wiring is fed into these locations to make it easier to pull the wire.

### STEP 2.3:

#### Bottom Plate Work

Drill or chisel holes at the bottom plate as indicated. One hole is for routing the power lead conduit and the other is for the thermostat sensor. These holes should be directly below the electrical box(es).

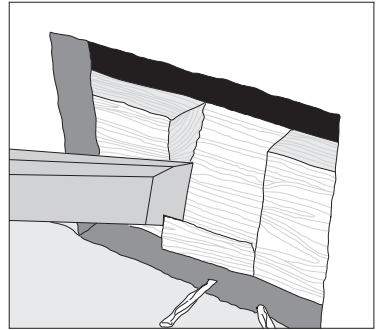
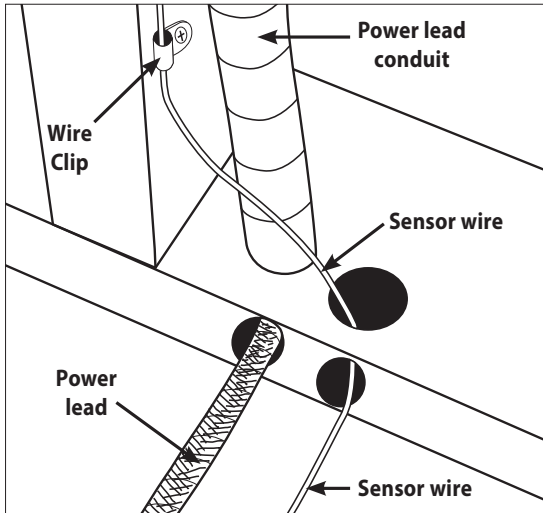

If going in to an existing wall, cut out dry wall and chisel out bottom plate to route wires to control.

### STEP 2.4:

#### Install Power Lead Conduit and Thermostat Sensor

##### **Power Lead Conduit:**

The shielded power lead can be installed with or without electrical conduit (recommended for added protection against nails or screws) depending on code requirements. Remove one of the knock-outs in the electrical box to route the power lead. If electrical conduit is not required by code, install a wire collar to secure the power leads where they enter the box. If conduit is required by code, install 1/2" (minimum) conduit from the bottom plate up to the electrical box. For multiple power leads (multiple cables) install 3/4" conduit.

##### **SunStat Thermostat Sensor:**

The SunStat sensor can be installed with or without electrical conduit depending on code requirements. Conduit is recommended for added protection against nails or screws. Do not place the sensor in the same conduit as the power leads to avoid possible interference. Open a separate knock-out in the bottom of the thermostat box. Feed the sensor (and conduit, if used) through the knock-out, down through the cut-out in the bottom plate, and out into the floor where the heating cable will be installed. If the sensor wire needs to be secured to the wall stud, wait until after the cable and sensor are completely installed on the floor.

### STEP 2.5:

#### Rough-in Wiring:

Install appropriate 12 or 14 AWG electrical wire from the circuit breaker or branch circuit source to the SunStat Thermostat electrical box (and SunStat Relay box(es) if needed) following all codes, see **Table 5**.

If SunStat Relay(s) are used, feed appropriate wire (see SunStat Relay installation manual for size and type) between the SunStat Relay(s) and the SunStat thermostat.

See SunStat Relay instructions for details of wire size and type.

### **There are 2 installation methods for securing WarmWire:**

- HeatMatrix offers an easy way to install WarmWire while providing crack-isolation, vapor management and waterproofing for installations with tile or stone. To install, WarmWire is simply pressed into the HeatMatrix channels at a selected spacing. With HeatMatrix, the space between rows can be easily adjusted to accommodate additional wire or provide more or less heat in defined areas.
- CableStrap is used for installations where crack-isolation and waterproofing are not required, or in areas that need a lower profile. CableStrap be covered with a smooth mortar finish for use under hardwood, laminate or resilient flooring. For CableStrap installation instructions, refer to Phase 4.

## **Phase 3 - Cable Installation with HeatMatrix**

### **STEP 3.1:**

#### **Determine the area for HeatMatrix**

HeatMatrix is installed in both unheated and heated areas to provide crack-isolation and waterproofing. Order a quantity that will cover the full square footage of the area to be tiled.

### **STEP 3.2:**

#### **Substrate preparation**

The substrate must be flat, clean, dry, structurally sound, adequately load bearing and free from material which may prevent bonding with the cement mortar.

### **STEP 3.3:**

#### **Cut lengths of HeatMatrix to fit the installation area**

Measure and cut HeatMatrix to the required length for each row. Mark the boundary edge on the subfloor to use as a guide for mortar application.

### **STEP 3.4:**

#### **Secure HeatMatrix to the substrate with mortar**

The type of mortar used to secure the membrane to the subfloor depends on the type of substrate. For most substrates, a premium modified thinset mortar is recommended. Apply the mortar for the first row using a 1/4" x 1/4" notched trowel. Place the cut length of HeatMatrix over the mortar. Position membrane, then readjust alignment if necessary by lifting one end, and pulling lightly. Do not leave gaps between sections of HeatMatrix and ensure the pattern is aligned. Work HeatMatrix in using a float or flat trowel. The entire surface of the fleece on the underside of the membrane should be securely bonded to the mortar. Observe the mortar open time while working. Trim out any rough drain openings or other obstructions if necessary. Repeat the application process for each row until the space to be tiled is completely covered.

### **STEP 3.5:**

#### **Outline the heated area**

Mark the areas where the WarmWire cable will be installed. WarmWire should not be installed:

- Within 3" of the wall perimeter, door jamb, tub or shower base
- Within 6" of toilet flanges
- Under cabinets or fixtures that have no clearance under them
- Within confined spaces like closets or pantries where the heat cannot disperse, particularly when objects are left on the floor.

Wire may be omitted from areas with no foot traffic. Refer to Appendix 1 for a table of recommended clearances.

### **STEP 3.6:**

#### **Make sure the cable fits**

Check the cable size to ensure it will fit inside the Heated Area at the selected wire spacing (see Table 2)

#### **⚠ WARNING**

The heating cable CANNOT be cut to fit. It must be kept its original length and fully embedded in the mortar in the floor. Any modification or mis-use of the heating cable will void the warranty and cause potential shock or fire hazard.

### **STEP 3.7:**

#### **Decide the cable layout**

Decide which direction the cables will run on the floor for the easiest coverage. Refer to the sample layouts in this manual for assistance. Depending on the shape of the area, it may help to think of it in terms of several smaller areas.

If more than one heating cable is to be installed in the area, all Power Leads must come back to the control or to a junction box and then to the control. Ensure there is sufficient space to allow this when planning the wire layout.

#### **⚠ WARNING**

NEVER run Power Leads across heating cables, under baseboard areas, or other potentially damaging areas.

NEVER place heating cables closer than 2" from other heating cables.

NEVER place heating cables closer than 1" from Power Leads.

### **STEP 3.8:**

#### **Position the Power Leads & Factory Splice**

Carefully cut the tie binding the power lead coil. Do not nick the braid covering the power lead. Locate the Factory Splice to ensure the power lead will reach the SunStat electrical box or junction box location. It is acceptable to run the power leads several feet in the floor area embedded in mortar if needed.

Draw an outline around the Factory Splice and move it aside. Cut a shallow channel in the HeatMatrix to allow the Factory Splice to lay flat with the rest of the heating cable in the channel.

Pull the Power Leads up into the wall or conduit.

Add hot glue in the channel and set the Factory Splice and Power Lead in place.

#### **⚠ CAUTION**

Completely embed the Factory Splice and heating cable in the floor mortar. Never bend the factory splice. Never allow any part of the Factory Splice or heating cable to enter a wall or cabinet or drop through the subfloor. Damage to the product will result.

### **STEP 3.9:**

#### **Install Cable**

Press the heating cable into the HeatMatrix channels at the determined spacing. A hand roller or grout float may be used to aid in installation.

### WarmWire spacing in HeatMatrix:

- Install WarmWire with 3-shapes in-between each row for approx. 12.3 W/ft<sup>2</sup> heat output (standard spacing)
- Alternate between 3-shapes and 2 for a higher heat output of 14.8 W/ft<sup>2</sup>
- Alternate between 3-shapes and 4 for a lower heat output of 10.6 W/ft<sup>2</sup>

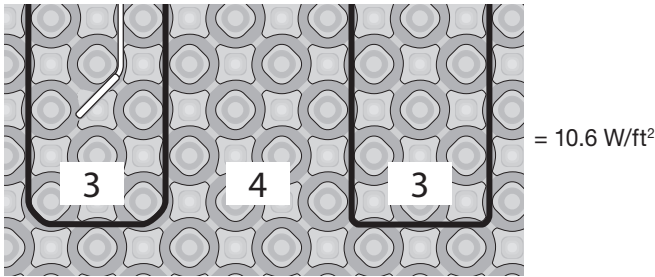
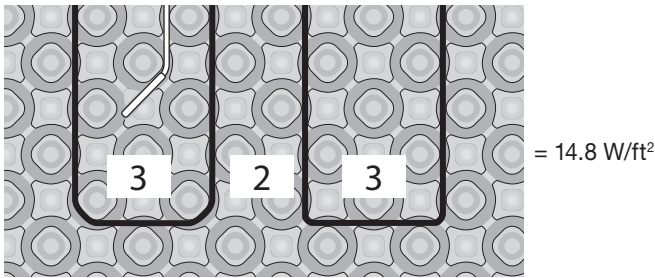
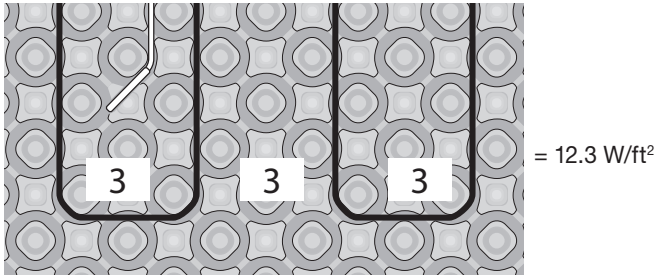

### STEP 3.10

#### Bench seat

If covering a bench seat or step area (not in a shower area), place a single run of cable up the riser. Use a section of HeatMatrix to secure the cable to the seat at the desired spacing, then install a single run down the riser. Use an "s-shaped" curve to avoid sharp bends in the cable at corners and help the cable to lay flat. The cable **MUST** be fully embedded in mortar and have approved floor coverings. Use hot glue where necessary to secure the cable flat against the riser.

#### **NOTICE**

NEVER space the cables less than 2" apart at any point, and never less than 2.5" average. Never space more than 3.5" average.

## Phase 4 - Cable Installation with CableStrap™

### STEP 4.1:

#### Floor Cleaning

The floor must be completely swept of all debris including all nails, dirt, wood, and other construction debris. Make absolutely sure there are no objects on the floor which might damage the wire.

Wet mop the floor at least twice to ensure there is no dirt or dust. This will allow proper bonding of the mortar and proper stick of any adhesives or double-sided tape used later.

### STEP 4.2:

#### Outline the Heated Area

Use a marker to outline the area where the heating cable will be installed. Refer to the Appendix for a table of recommended clearances.

**Cabinet vanities:** Draw the border right up to the toe-kick. The wire can be installed up to 1" away from the vanity toe-kick.

**Tubs and shower entries:** Draw the border about 3" from the edge of the tub or shower.

**Walls:** Draw the border about 3" from the wall. If required to help the cable fit better, it may be drawn 4" to 6" from the wall since people do not generally stand this close to a wall anyway. It may also be drawn closer, but be careful that the cable will not be placed under any trimwork.

#### WARNING

- Keep the cable at least 6" from toilet flanges
- Do not run the cable under cabinets or fixtures that have no clearance under them.
- Avoid running the cable into a small closet or pantry. The heat cannot escape and things can be laid on the floor, blocking the heat and potentially overheating and causing a fire hazard.

### STEP 4.3

#### Make Sure the Cable Fits

Check the cable size to ensure it will fit inside the Heated Area at the selected wire spacing. See Table 2.

#### WARNING

Remember the heating cable length CANNOT be cut to fit. It must be kept its original length and fully embedded in the mortar in the floor. Any modification or mis-use of the heating cable will void the warranty and cause potential shock or fire hazard.

### STEP 4.4

#### Decide the Layout

Decide which direction the cables will run on the floor for the easiest coverage. Refer to the sample layouts in this manual for assistance. Depending on the shape of the area, it may help to think of it in terms of several smaller areas.

## Install CableStrap

### STEP 4.5

Measure the edge of the Heated Area where CableStrap will be installed.

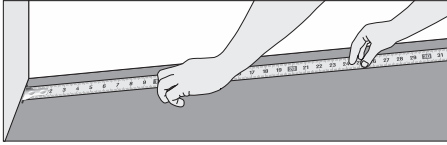

### STEP 4.6

Cut the CableStrap to length using metal shears.

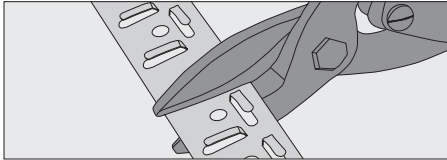

### STEP 4.7

Secure the strap to the floor. Depending on the floor type, different methods may be used.

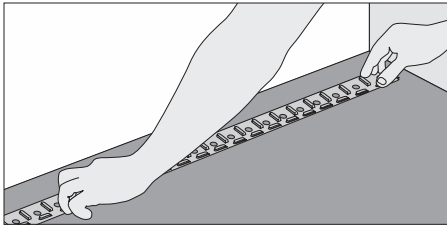

**Plywood, cement board, or similar:** Galvanized nails or screws may be used to secure the strap every 6" to 10".

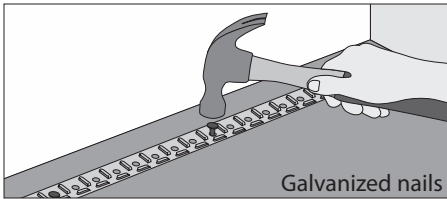

Galvanized nails

OR

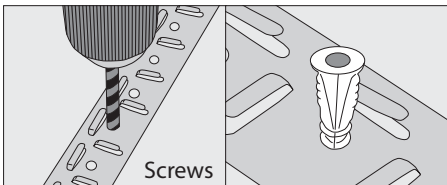

Screws

**Concrete, self-level, or similar:** Double-sided tape (if included with your cable), hot glue, or strong spray adhesive may be used if the floor is well cleaned and the strap is wiped free of any oils. However, it is highly recommended to also place screws at each end of the strap, and every 4 to 5 feet, to ensure it does not come loose. If using a strong spray adhesive, apply to both the back of the strap and the floor where it will be placed, and carefully follow all spray manufacturer's instructions and cautions.

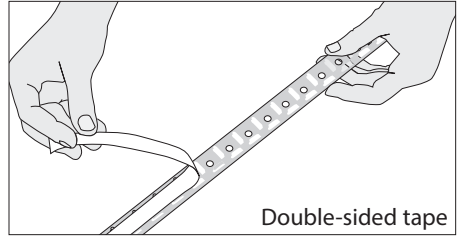

Double-sided tape

OR

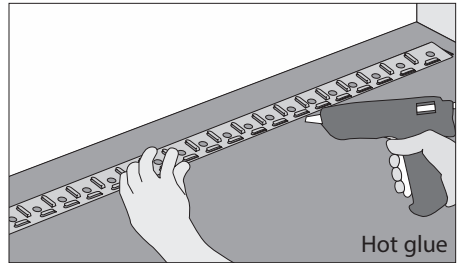

Hot glue

OR

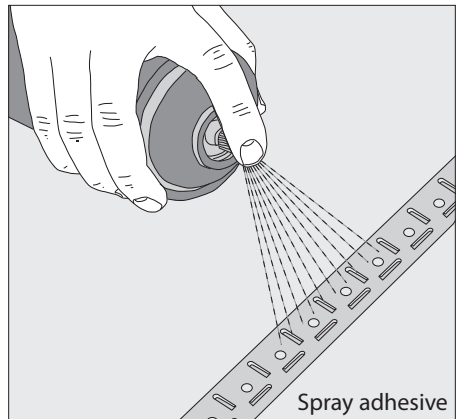

Spray adhesive

Cut another piece of strap for the other end of the area and secure to the floor.

## **⚠ CAUTION**

Completely embed the Factory Splice and heating cable in the floor mortar. Never bend the factory splice. Never allow any part of the Factory Splice or heating cable to enter a wall or cabinet or drop through the subfloor. Damage to the product will result.

### **Position the Power Leads & Factory Splice**

#### **STEP 4.8**

Carefully cut the tie binding the power lead coil. Do not nick the braid covering the power lead. Locate the Factory Splice to ensure the power lead will reach the SunStat electrical box or junction box location. It is acceptable to run the power leads several feet in the floor area embedded in mortar if needed.

#### **STEP 4.9**

Draw an outline around the Factory Splice and move it aside. Chisel a shallow channel to allow the Factory Splice to lay flat with the rest of the heating cable in the channel. Add hot glue in the channel and set the Factory Splice in place.

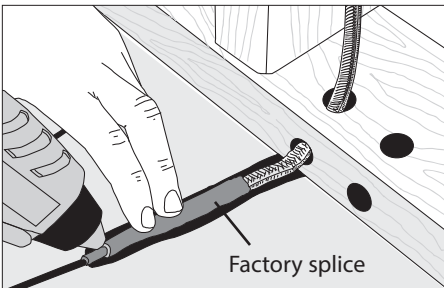
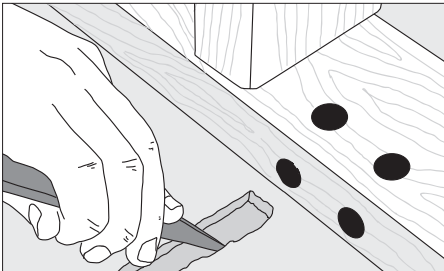

### **Installing Cables on CableStrap**

#### **STEP 4.10**

Weave the cable back and forth across the area at the desired spacing until the other side of the room has been reached. Once this area is completed, press down all the tabs.

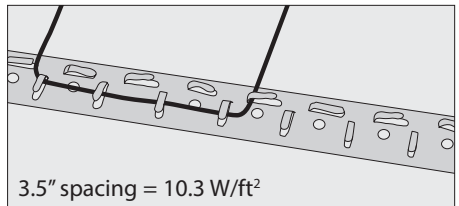
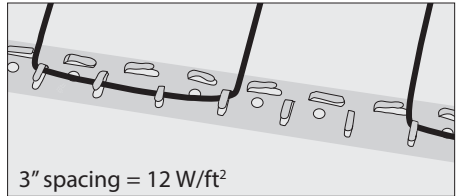
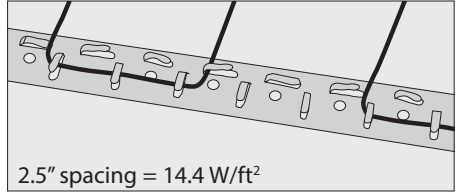
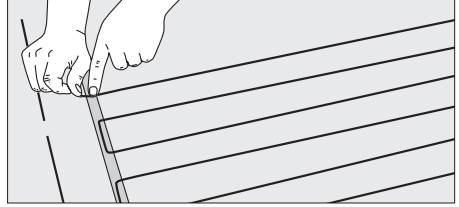

**NEVER** space the cables less than 2" apart at any point, and never less than 2.5" average. Never space more than 3.5" average.

#### **STEP 4.11**

If there are additional areas to cover with cable, cut the lengths of strap necessary, attach them to the floor, and begin weaving the cable into that area.



### STEP 4.12

To secure long lengths of heating cable, place additional, short lengths of the strap at 3–4-ft. intervals. Spray the back of the strap with a high-tack adhesive, and slide the strap, upside down, under the cables. Turn the strap over when it is positioned and adhere to the floor. Press the tabs down over the cables. If a spray adhesive was not used, carefully secure these short lengths of strap to the floor without damaging the cable.

### Install second cable

### STEP 4.13

If a second cable is to be installed in the area, all power leads must come back to the control, or to a junction box and then to the control. NEVER run power leads across heating cables, under baseboard areas, or other potentially damaging areas. Never join two cables in series.

### Other Installations

Because many different room shapes and floor obstructions may be encountered in any given installation, additional layouts are provided below to assist in determining the best way to complete installations in odd-shaped areas.

### Corner shower or vanity using CableStrap

### STEP 4.14

For an angled area, such as a corner shower, lay CableStrap at an angle and adjust tab spacing to keep the wire spacing consistent. Maintain a minimum of 3" distance between the shower curb and wire.

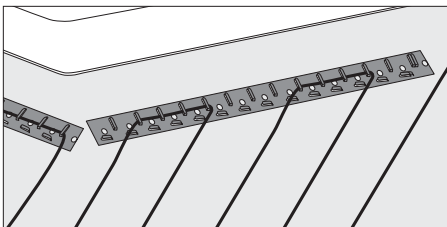

### STEP 4.15

Fill in the section with cable. Make sure that the cables are spaced evenly and parallel to one another.

### Door entryway using CableStrap

### STEP 4.16

For an entryway or other small area where warmth is required, cut small sections of strap to fit the ends of that area. Keep wire 3" away from the framing.

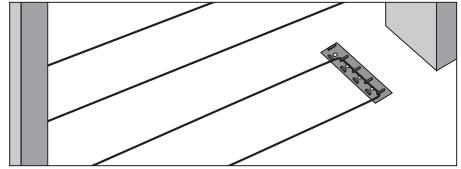

### STEP 4.17

Fill in with cable, adjusting spacing as necessary to fill in as much of the area as possible.

### Bench Seat

### STEP 4.18

If covering a bench seat or step area (not in a shower area), place a single run of cable up the riser. Use CableStrap to secure the cable to the seat area at the desired spacing, then install a single run down the riser. Use an "s-shaped" curve to avoid sharp bends in the cable at corners and help the cable to lay flat. Again, the cable on the riser and seat area MUST be fully embedded in mortar and have approved floor coverings. Use hot glue where necessary to secure the cable flat against the riser.

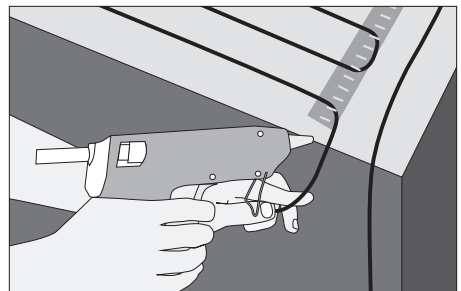

## Phase 5 - Shower Area Installation

### **NOTICE**

This application into a shower area must be verified by the local inspector or the authority having jurisdiction (AHJ).

#### **STEP 5.1**

Cables only with (-W) on the nameplate label may be installed into a floor or bench seat located in a shower area. It must never be installed into walls. In general, the cable should be completely embedded into mortar as close to the surface coverings as possible. The cable may be placed directly below the tile or stone coverings for the best performance by using hot glue to secure the cable to the substrate.

If HeatMatrix or CableStraps are intended to be used instead, two methods may be used to help avoid obstructing the flow of water to the drain when grout sealants begin to degrade: (1) Place the HeatMatrix or CableStrap below the waterproofing system used, or (2) place a 3" wide strip of HeatMatrix or CableStrap only around the perimeter of the shower floor and cover above this with HeatMatrix Joint Strip or similar waterproofing and use hot glue everywhere else to secure the cable.

See the Appendix for an example of this type installation.

### **⚠ CAUTION**

Do not secure HeatMatrix or CableStrap with fasteners that may penetrate the waterproofing membrane.

It is recommended that a dedicated cable be installed in the shower area separate from the rest of the bath floor. In case there is ever a problem with the shower installation, this cable could be disconnected without loss of heat to the rest of the floor.

#### **STEP 5.2**

Make sure the power lead factory splice (the connection between the power leads and the heating cable) is located outside the shower area and at least 1' away from shower openings and other similar areas normally exposed to water. Make sure the control is located at least 4' away from shower openings such that it cannot be exposed to water or touched by a person in the shower area.

#### **STEP 5.3**

If the heating cable must enter the shower area over a curb, secure the cable at the edges in an "s-shaped" curve to ensure the cable is not bent sharply or pinched when surface coverings are installed. If the cable is installed below the waterproofing membrane, the curb surface may be notched 1" wide and 1/8" deep to help the cable lay flat, and coated with mortar before applying the waterproofing. Do not damage any waterproofing components, and do not run the heating cable through a non-masonry curb, causing it to overheat.

#### **STEP 5.4**

Fill in the floor area with cable. Around the drain leave at least 2" spacing from the edge of the flange. Make sure cable is not placed where door hardware, handrails, or other items may mount to the floor.

SunStat Thermostat

A (-W) on the nameplate label indicates a WarmWire cable is approved for installation in shower floors and/or benches.

Factory Splice

Floor Sensor

Thin Set Mortar

WarmWire

Tile/Stone

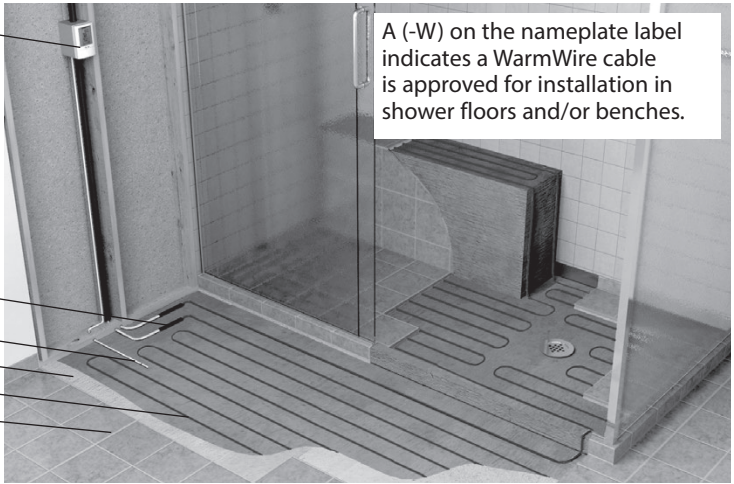

### STEP 5.5

If covering a bench seat in the shower with cable, secure it with hot glue or with HeatMatrix or CableStrap located underneath waterproofing. Do not use fasteners that penetrate any waterproofing membrane or waterproofing system. Use hot glue to secure a single run of cable up the side of the bench riser. Fill in the seat area with cable. Then secure a single run of cable down the riser if needed. Use an "s-shaped" curve to avoid sharp bends in the cable at corners and help the cable to lay flat.

### STEP 5.6

If the cable cannot exit the shower area, the end of the cable has a waterproof splice that may be located in the shower area, fully embedded into the mortar like the heating cable.

### STEP 5.7

If any part of the heating cable entering a shower area is damaged during installation, **do not attempt to repair it**. A field repair or modification of the cable may result in serious shock hazard.

## Phase 6 - Final Steps

### STEP 6.1

After the cable installation is completed, inspect the work. Make sure cable spacings are correct and consistent, having no place where cables are less than 2" spacing, nor greater than 4" spacing in the heated areas, no cables cross over each other, all the cables are undamaged, and all areas to be heated are covered with cable.

### STEP 6.2

Take resistance readings of the cable again to make sure it has not been damaged during the installation. This is very important to do. Record these readings in the Cable and Sensor Resistance Log (Table 4).

### STEP 6.3

Lay cardboard, carpet, or similar material over the cables to protect them from damage until the floor covering is installed.

## Phase 7 - Finish Wiring

### STEP 7.1

Feed the power leads from the cable up through the hole drilled in the baseplate, or up into the conduit to the control electrical box (or junction box if one was used).

### STEP 7.2

Below the control, or wherever the floor sensor is to be located, measure at least 1 ft. into the heated area. Mark the spot where the sensor will be attached to the floor. Be sure to locate the sensor exactly between two of the heating cables.

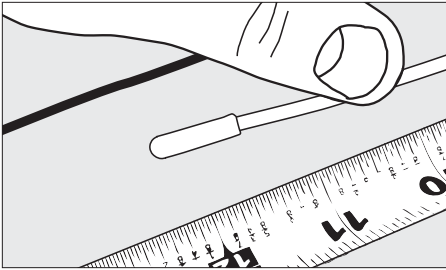

When using HeatMatrix, the sensor wire is pressed into the channel between 2 wire rows. For 3-shape spacing, the sensor is placed at an angle with a small portion of the membrane cut out to allow the sensor to sit flush. For 4-shape spacing, the sensor is positioned in the channel exactly between 2 wires. Do not install the sensor between wire spaced 2-shapes apart.

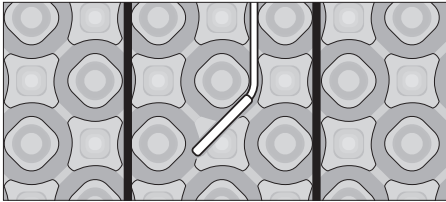

3-shape spacing

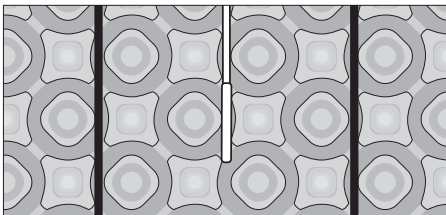

4-shape spacing

### STEP 7.3

To make sure the sensor tip does not create a high spot in the floor, it may be necessary to chisel a channel into the floor and lay the sensor tip into the channel. Hot glue the tip into place.

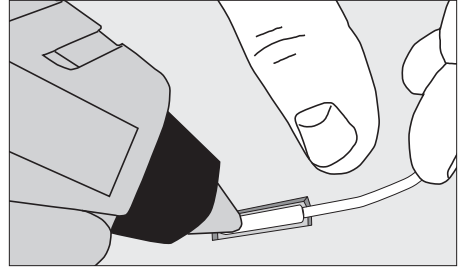

### STEP 7.4

Feed the sensor wire up to the control box. Finish by securing a steel nail plate over the wires to protect them against baseboard nails later.

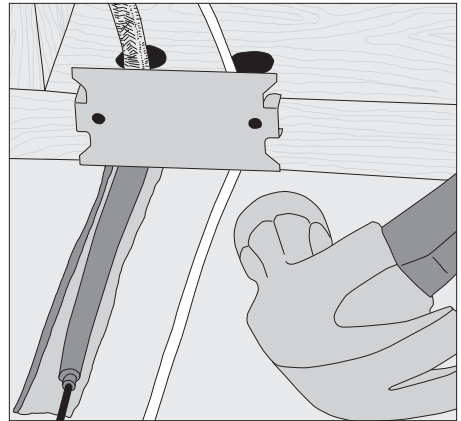

### STEP 7.5

If it was necessary to end a power lead at a junction box, feed 14- or 12-gauge electrical wire from this box to the control box.

**Tip:** If more than one cable was installed, label the ends of the power leads with a brief description as to which area they supply power. Use tape to label them "Cable 1," "Cable 2," "Kitchen," "Bath," or similar. This will make it easier to identify the leads later on. Take photos of the installation. This will provide a useful record for any future needs.

## Phase 8 - Control Installation

### STEP 8.1:

If it has not already been done, install an electrical box for the SunStat® thermostat and SunStat Relay. See Step 2.2 for details.

### STEP 8.2

Read and follow the instructions included with the SunStat thermostat and SunStat Relay for complete connection instructions, requirements, and mounting.

### STEP 8.3

Make any final connections to the circuit breaker or branch circuit source.

### WARNING

Make sure 120 VAC is supplied to 120 VAC cables and 240 VAC is supplied to 240 VAC cables. Otherwise, dangerous overheating and possible fire hazard can result.

### STEP 8.4

#### System Start Up

After all controls are installed, do not energize the system, except to briefly test operation of all components (no longer than 10 minutes). **Do not put the system into full operation until the tile or flooring installer verifies all cement materials are fully cured (typically two to four weeks).** See mortar manufacturer's instructions for recommended curing time.

### NOTICE

Refer to the installation sheets provided with the controls for proper setting. The system should now operate as designed. **Please leave this instruction manual, SunStat Control instructions, and copies of photos of the installed heating system with the end user.**

### NOTICE

Most laminate and wood floor manufacturers specify their flooring should not be subjected to temperatures over 82° to 84°F (27° to 28°C). Check with the flooring dealer or manufacturer and set the thermostat Floor Limit temperature appropriately.

## Phase 9 - Floor Coverings / General Recommendations

### NOTICE

Please note, this installation manual is not a structural or a floor covering installation manual and is intended only for general guidance as it applies to the SunTouch WarmWire product. It is recommended to consult with professional flooring installers to make sure proper materials are used and proper installation techniques are followed.

When installing tile or stone, the Tile Council of North America (TCNA) guidelines or ANSI specifications should be followed as a minimum standard.

A latex-modified thin-set cement-based mortar and grout is recommended instead of water-based multi-purpose materials when installing a radiant product.

## **NOTICE**

Do not use solvent based adhesives or pre-mix mortars because they are not as heat resistant and do not conduct heat well.

- When installing over HeatMatrix, read and follow the instructions given with the HeatMatrix product. Apply the mortar by filling all voids in the HeatMatrix with the flat side of the trowel, then comb to ensure 100% coverage. Avoid lining up tile grout lines with joints between sections of HeatMatrix.
- Select the proper size trowel for the installation of tile or stone. We recommend a minimum 3/8" x 1/4" trowel. This trowel works well for most ceramic tile. A thicker thin-set can be used if required. Select the thin-set thickness in accordance with the floor covering requirements.
- For additional information on tile installation, please contact TCNA at 864-646-8453 or visit their web site at [www.tileusa.com](http://www.tileusa.com), or contact NTCA at 601-939-2071 or see their web site at [www.tile-assn.com](http://www.tile-assn.com).
- When installing floor coverings other than tile or stone, follow industry and/or manufacturer's recommendations. Ensure the wire is first covered with a layer of self-leveling cement based mortar, letting it cure fully before applying any surface underlayment, floating wood or laminate flooring, carpet, etc.
- With 3" or 3.5" spacing, the combined R-values of all floor coverings over the wire should not exceed R-2.5. With 2.5" spacing, the combined R-value should not exceed R-1.5. Higher R-values will diminish performance and trap too much heat. Consult the floor covering manufacturer to verify compatibility with radiant electric heat.
- Make sure nails, screws, or other fasteners do not penetrate the floor in the heated area. The wire can easily be damaged by fasteners penetrating the floor.
- All floor coverings must be in direct contact with the cement-based mortar encasing the wire. Do not elevate the floor above the mortar mass.
- Do not install 2" x 4" wooden nailers (sleepers) on top of a slab for the purpose of attaching hardwood. Any air gap between the heating wire and the finished floor covering will drastically reduce the overall output of the heated floor.
- Care should be taken when laying area rugs, throw rugs, and other surface products on the floor. Most products are okay to use, but if in doubt, consult the product manufacturer for compatibility. Do not use rubber backed products.
- When placing furniture make sure an air clearance of at least 1-1/2" is available. Furniture able to trap heat can damage the heating system, the flooring, and the furniture over time.
- After floor coverings have been installed, take resistance readings of the cable again to make sure it has not been inadvertently damaged. Record these readings in the Cable and Sensor Resistance Log (Table 4).

## **Phase 10 - Install Insulation**

Insulate under the subfloor for better performance and efficiency of the system. Refer to the Appendix for diagrams and insulation recommendations.

## Appendix 1: Minimum Clearances for WarmWire

	Minimum Clearance
Bathroom vanity or kitchen cabinet toe-kick	1"
Showers or tub boundaries	3"
Doorway framing	3"
Walls	3"
Toilet flange	6"
Other heating wire	2"
Heating cable power lead	1"
Appliances (washer, dryer, oven)	1"
Baseboard heaters or radiators	3"
Below a built-in, cabinet, furniture	1-1/2"
Drains	2"

**Do not install WarmWire in closets, pantries or in other small enclosed spaces.**

## Appendix 2: Types of Construction and Applications

### Types of Construction

#### Tile or stone applications with HeatMatrix

To install tile or stone over HeatMatrix and WarmWire, refer to the manufacturers recommendations on mortar type, notch size and curing time. For areas exposed to surface water, the seam between rows of HeatMatrix should be sealed with HeatMatrix Joint Strip. This is done by troweling a strip of mortar over the seam, then pressing Joint Strip into the mortar. Ensure these sections are as flush with the adjacent surfaces as possible. Once set, the tile can be installed over these areas as usual.

#### Laminate, resilient or hardwood over HeatMatrix

When applying mortar over HeatMatrix in this application, the finish must be smooth instead of notched. Do not use nails or screws to attach any type of flooring to the finished mortar surface. A 'floating' floor installation is typically recommended for wood or laminate flooring due to expansion and contraction caused by changes in floor temperature. When selecting floor coverings, the R-value should not exceed R-2.5. when using 3" or 3.5" wire spacing and not exceed R-1.5 when using 2.5" spacing.

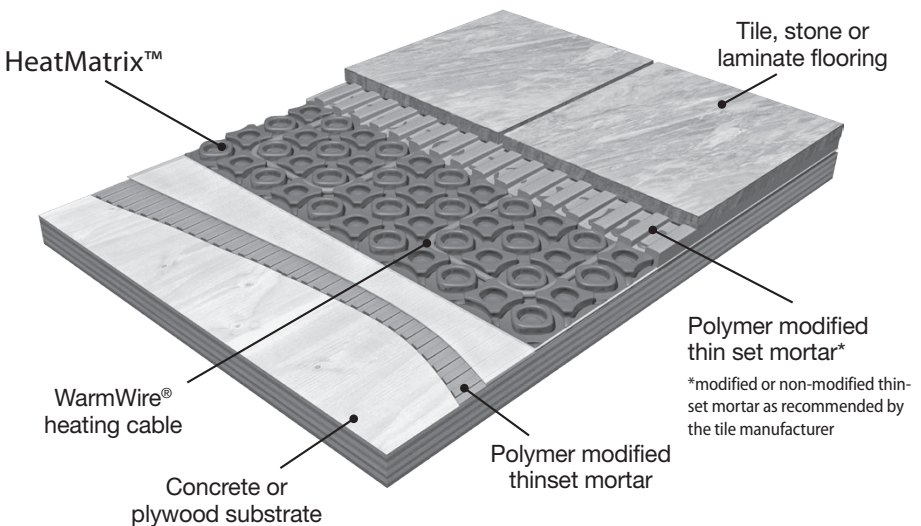



## Mortar Applications with CableStrip:

1. If a backer board or plywood sheeting is used to strengthen the floor, or if the heating wire will be placed directly onto the slab, install WarmWire in the thin-set mortar bond coat above these materials.
2. If a thicker mortar bed, or self-leveling concrete, is used to strengthen the floor, the heating wire can be installed in either the mortar bed (dry-set) or in the mortar bond coat directly below the tile or stone.

The heating wire is generally installed above the self-leveling mortar in a thin-set bond coat. Use plastic lath instead of the typical metal lath when installing in a self-leveling layer.

## Self-leveling mortar with CableStrip:

Self-leveling mortar may be used in CableStrip / WarmWire installations when the finished surface needs to be smooth. This applies to engineered wood, vinyl, laminate, or carpet floor coverings. Attach the WarmWire to CableStrip on the subfloor or slab, then pour self-leveling mortar 1/4" to 1/2" thick according to manufacturer's specifications. Install floor covering after the mortar has fully cured.

## Special Precautions

**Isolation Membrane:** Install the heating wire above the membrane, whenever possible, unless recommended otherwise by the membrane manufacturer.

**Insulation:** Insulation dramatically enhances the performance and efficiency of floor-warming systems. Do not install rigid insulation directly above or below backer board or mortar.

**Mosaic Tile:** When installing mosaic tile, it is recommended to apply a two-step process. First, embed the heating wire in a thin self-level mortar bed (1/4"–3/8"), then thin-set the mosaic tile according to typical practice.

**Expansion Joints:** Do not install heating wires through an expansion joint. Install heating wire right up to the joint, if necessary, but not through the joint.

### ⚠ CAUTION

Never bang a trowel on the Heating Wire to remove excess mortar from the trowel. This could damage the heating wire.

## Double-plywood over frame floor

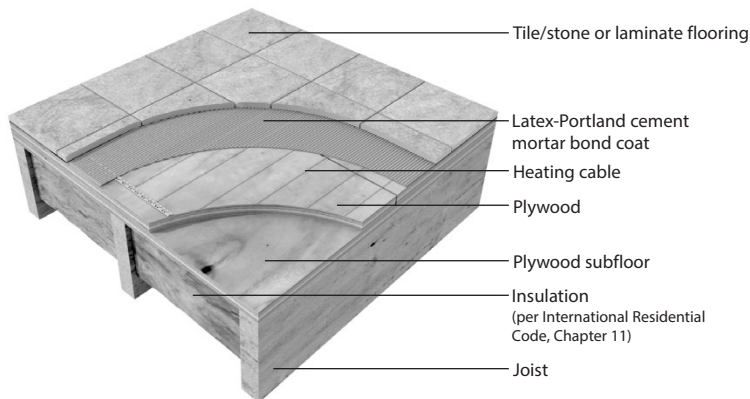



## Cement backboard over frame floor

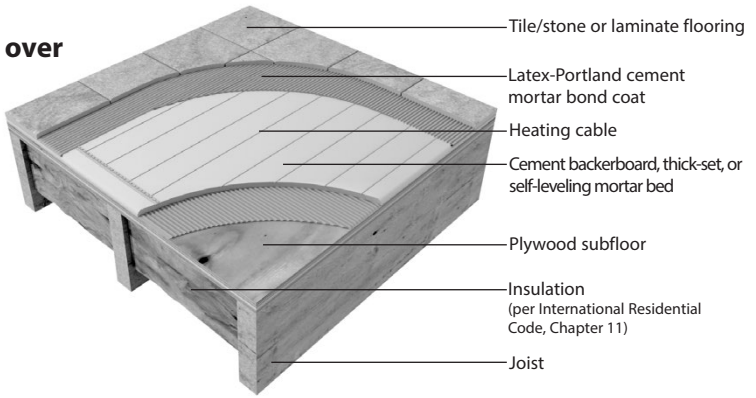

## Thin-set over slab on grade

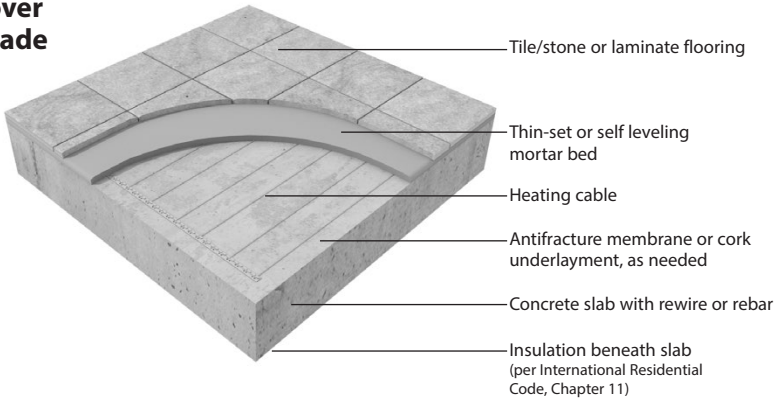

## Connecting Multiple Cables

### ⚠ WARNING

To prevent the risk of personal injury and/or death, do not perform any electrical work unless qualified to do so. Work should be done with great care and with power turned off to the circuit being worked on. Follow all local building and electrical codes.

### SunStat / Relay Connections

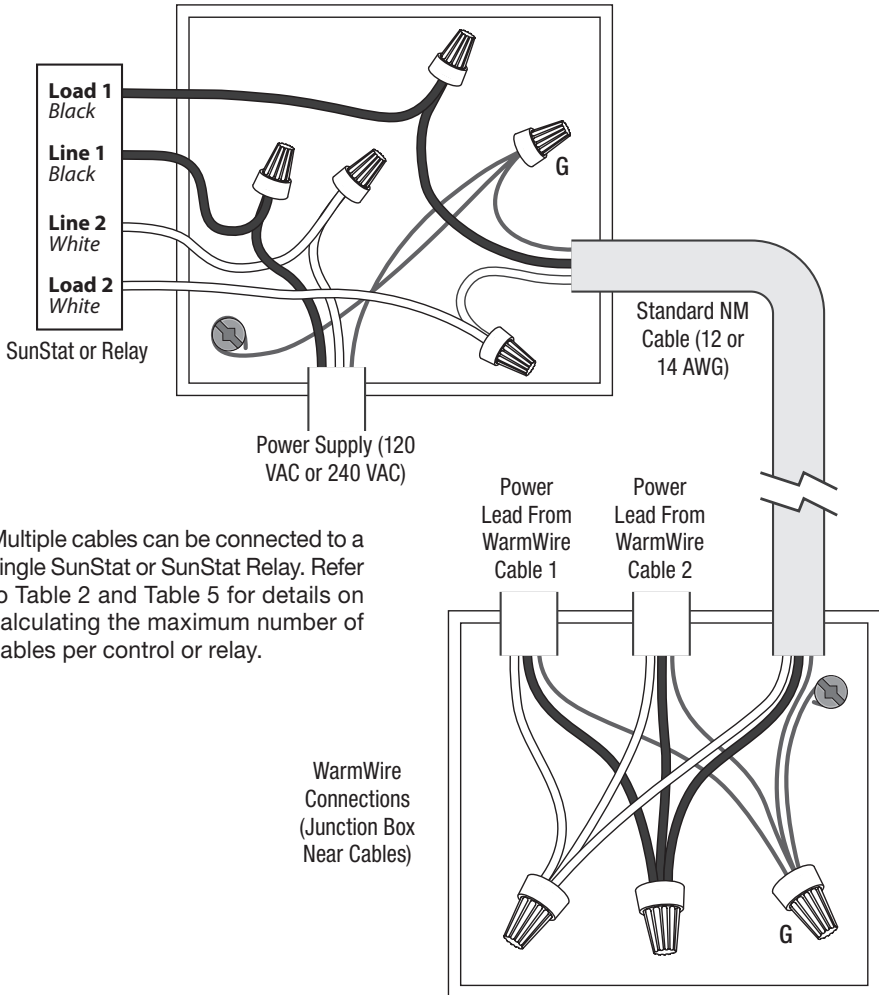

Multiple cables can be connected to a single SunStat or SunStat Relay. Refer to Table 2 and Table 5 for details on calculating the maximum number of cables per control or relay.

WarmWire  
Connections  
(Junction Box  
Near Cables)

### ⚠ WARNING

The SunStat is not fully illustrated in these diagrams in order to simplify them. These diagrams are given only as examples of how to properly connect multiple cables. Care must be taken not to overfill a box. Be sure to use wire nuts that are the correct size for the connections being made. Follow all codes for wiring.

All electrical work must be done by a qualified licensed electrician in accordance with local building and electrical codes, and the National Electrical Code (NEC), especially Article 424 of the NEC, ANSI/NFPA70 and Section 62 of CEC Part 1.

## Appendix: Sample Layouts

### Kitchen and Family Room (normal heat loss, slab on grade with insulation)

Two zones, 240 volts: Three cables. 190 ft. of CableStrap, or eight 25-ft. rolls.

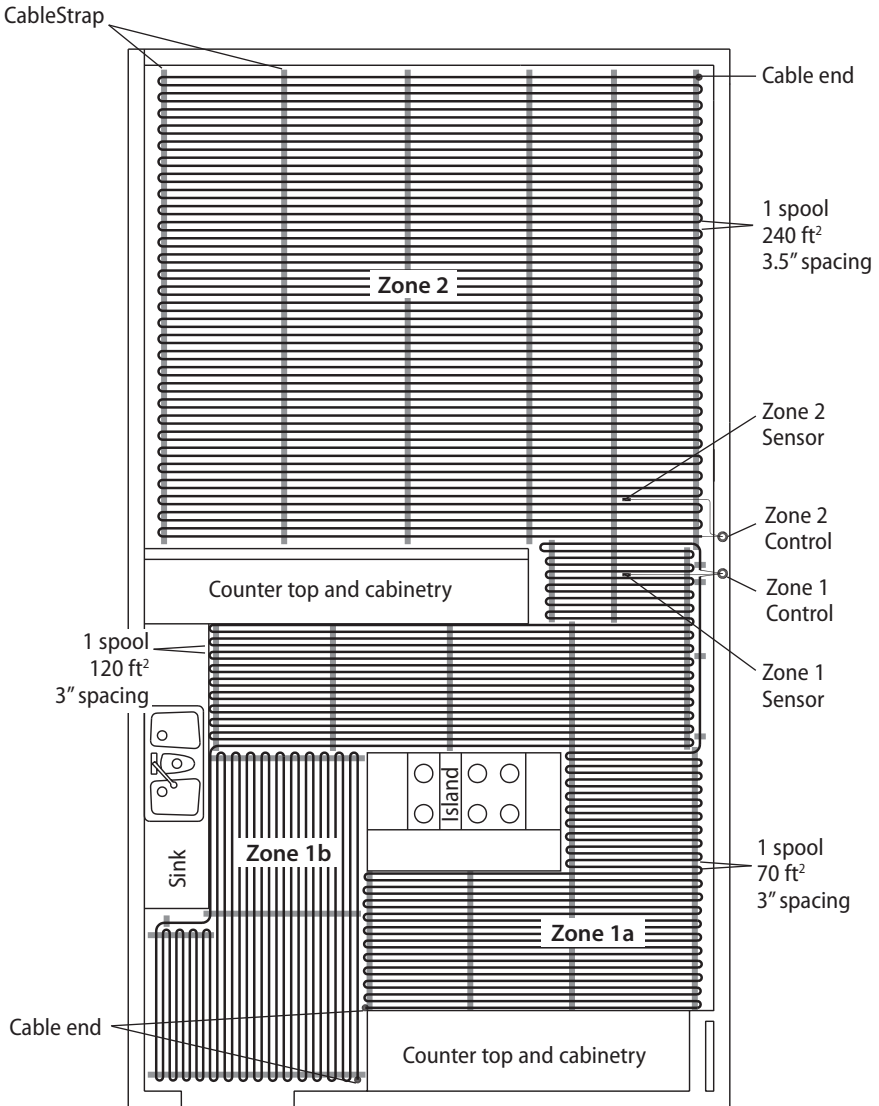

**Kitchen and SunRoom** (normal and high heat loss, framed floor construction)

One zone, 240 volts: Two cables. 104 ft. of CableStrap, or five 25-ft. rolls.

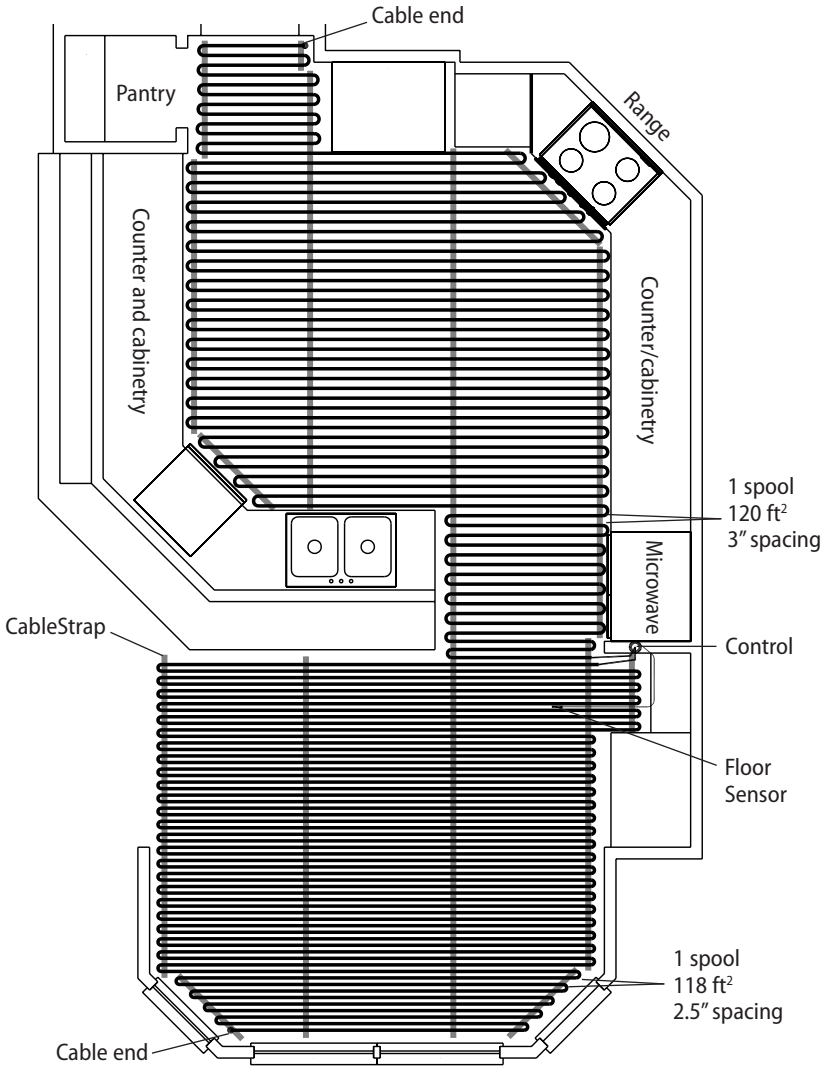

**Master Bathroom** (normal heat loss, framed floor construction)

One zone, 120 volts: One cable. 35 ft. of CableStrap, or two 25-ft. rolls.

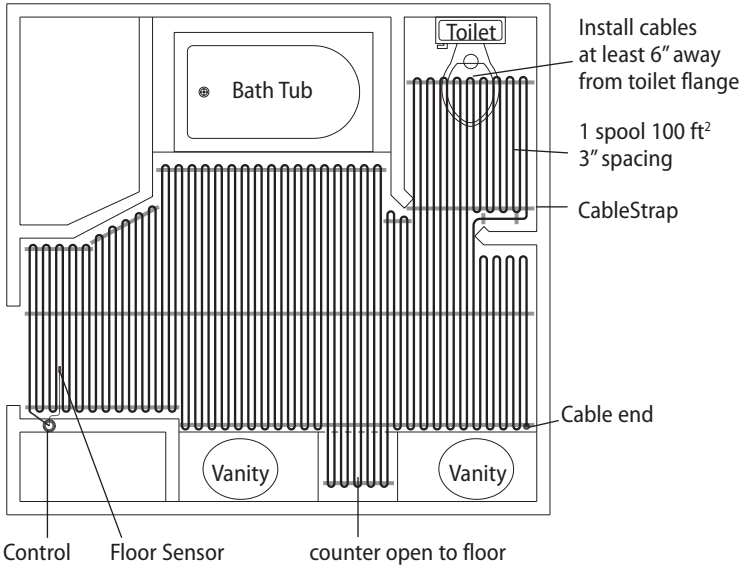

**Master Bathroom**

(normal heat loss, framed floor construction)

One zone, 120 volts: One cable. 49 ft. of CableStrap, or two 25-ft. rolls.

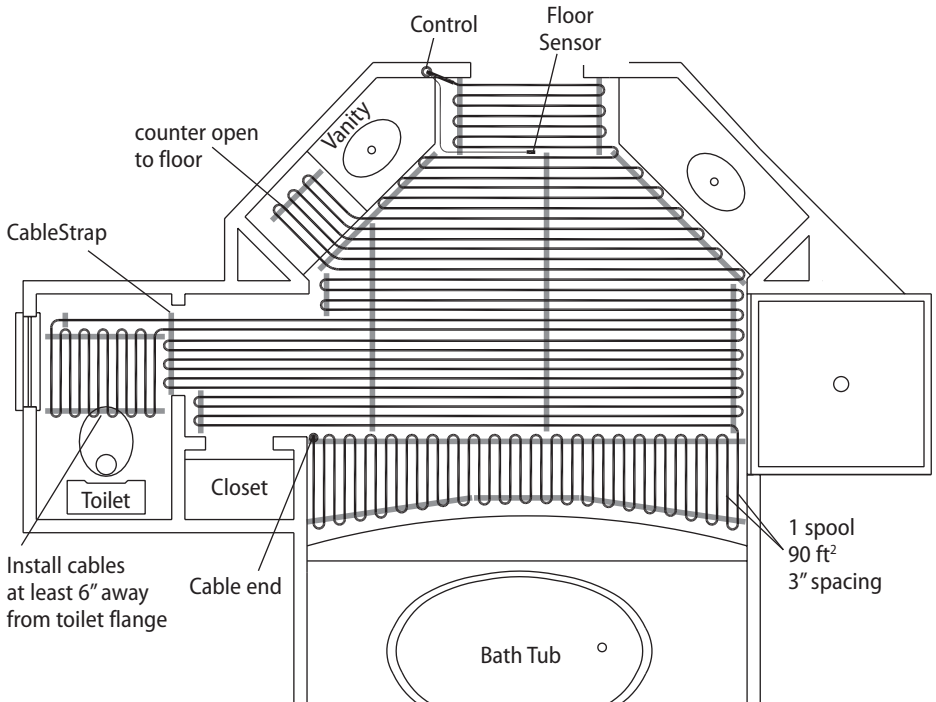

**Basement Bathroom** (high heat loss, below grade basement slab)

One zone, 120 volts: One cable. 39 ft. of CableStrap, or two 25-ft. rolls.

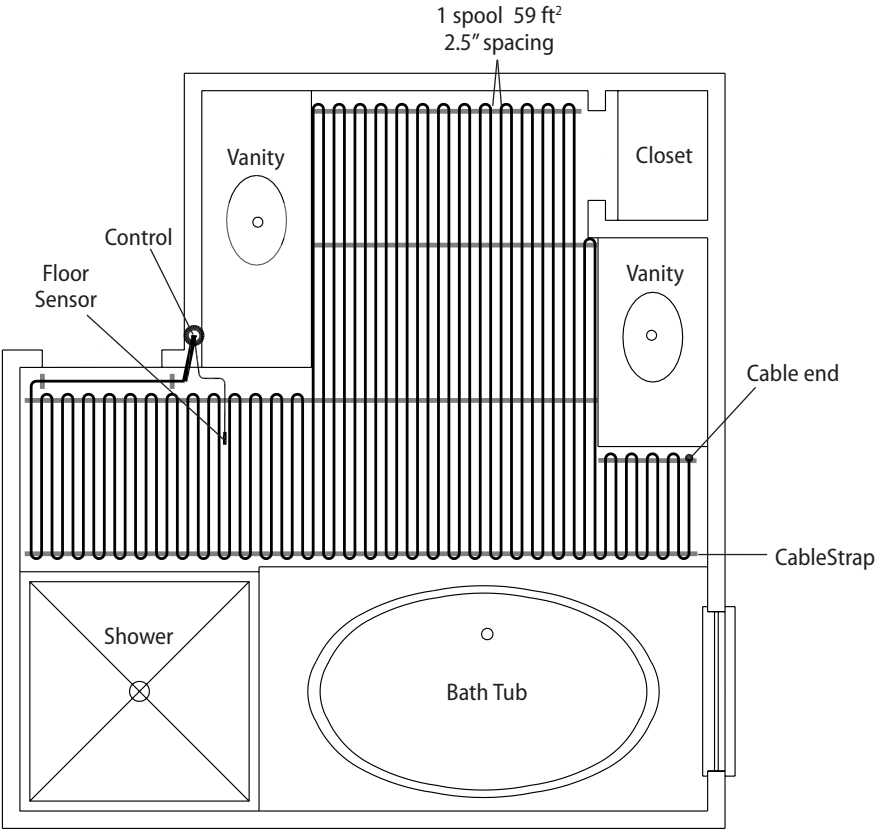

**Master Bathroom** (normal heat loss, framed floor construction)

Two zones, 120 volts: Two Cables

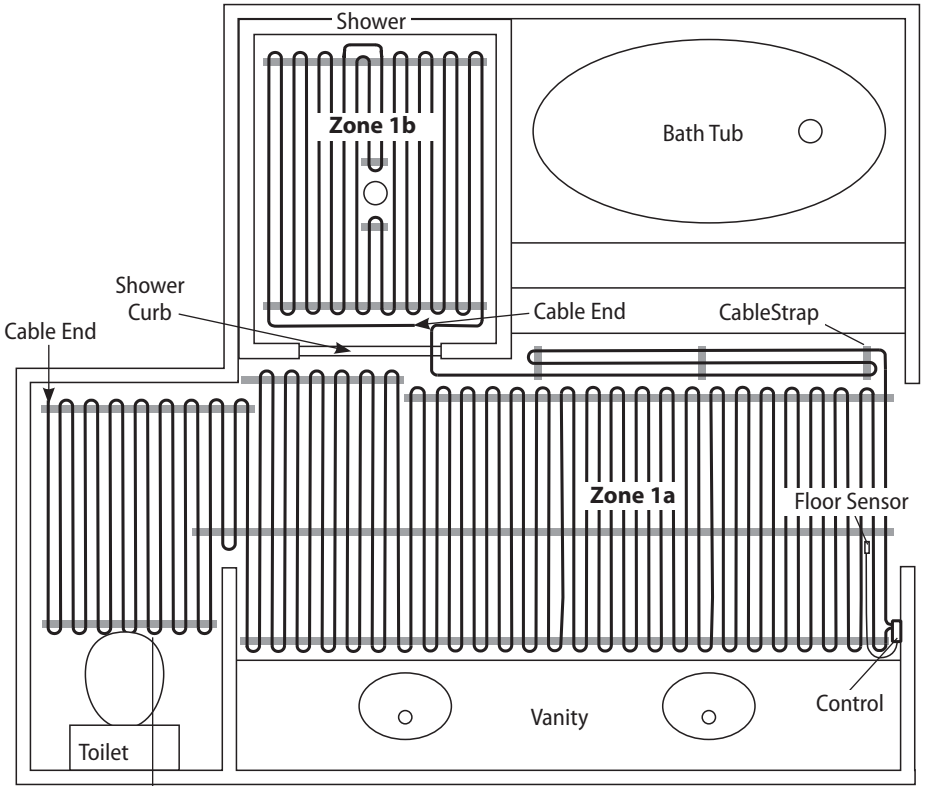

Install cables at least 6" away from toilet rings

Example of Cables only with (-W) on the nameplate label, where cable is installed in a shower area and enters over the curb.

**Shower Details**

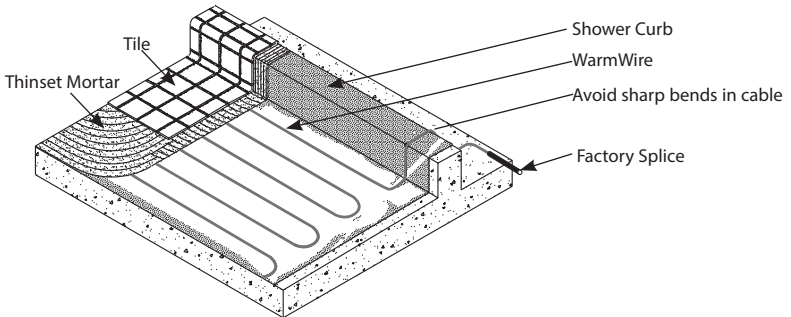

## Installing WarmWire above the waterproof liner

WarmWire can be installed above the waterproofing liner if the attachment method does not puncture the liner. A overlay of thinset is first applied over the liner. CableStrap or 2-inch HeatMatrix strips are then attached to opposite sides of the shower using hot glue or double sided tape. Leave a 2 inch gap between the drain flange and WarmWire. When using HeatMatrix, strips are covered with mortar and Joint Tape after the wire is in place. This reduces the chance of water becoming trapped in the low sections of the HeatMatrix membrane. Ensure WarmWire is fully embedded within a cement based mortar before tiling.

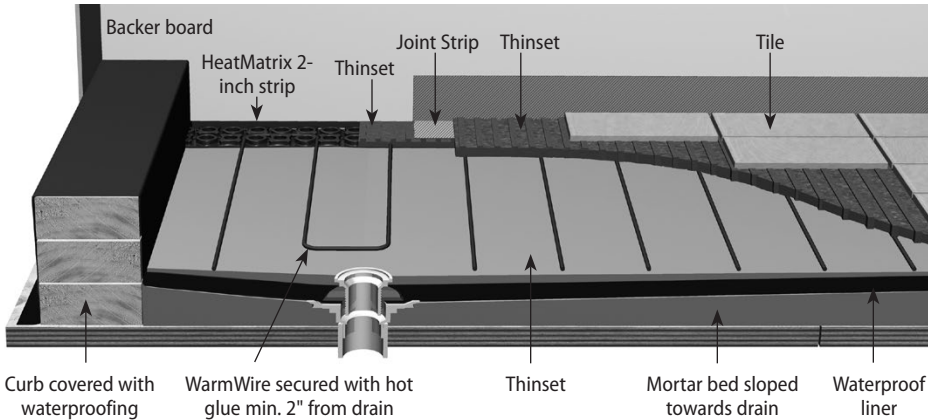

## Installing WarmWire below the waterproof liner

WarmWire can be installed on a sloped mortar bed below the waterproof liner layer using CableStrap or a 2-inch strip of HeatMatrix. Ensure the WarmWire and CableStrap or HeatMatrix are fully covered in mortar, and trowel to provide a smooth finished surface. Apply waterproof liner over the smoothed mortar surface according to the liner manufacturer's instructions. Ensure the coverings above the waterproof liner do not exceed R-0.5 to avoid capturing too much heat.

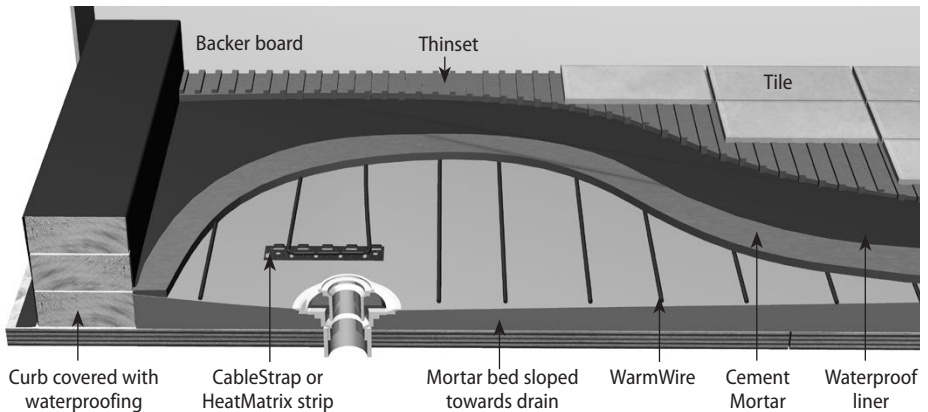

### NOTICE

See phase 5 for complete details and Cautions. This application into a shower area must be verified by the local inspector or the authority having jurisdiction.



## Troubleshooting Guide

If not qualified to perform electrical installations, it is strongly recommended that a qualified, licensed electrician be hired to install the heating cables and related electrical components. If problems with the system arise, please consult the troubleshooting guide below.

### WARNING

Any electrical troubleshooting work should be performed with the power removed from the circuit, unless otherwise noted.

Problem	Possible Cause	Solution
Cable resistance measurement is outside the range printed on the nameplate label.	An analog ohmmeter (using a moving needle) was used to take the reading.	Obtain a digital ohmmeter able to read 0 to 20,000 ohms and remeasure the resistance.
	If measurement shows an open or short circuit, the cable has been damaged.	Record resistances between all wires and contact the manufacturer.
	If measurement is just a little low or high, room temperature has affected the resistance.	Make the room temperature 65°–75°F (18°–24°C), or contact the manufacturer.
	The resistance measurement could be from more than one cable wired in series, or wired in parallel. Either will provide false resistance readings.	Make sure resistance measurements are for only one cable at a time.
	The multi-meter may be set to the wrong scale.	The ohmmeter should typically be set to the 200 (200Ω) scale. For heating wire with resistance range higher than 200 ohms on the nameplate label, set the meter to the 2000 ohm (2kΩ) scale.
Floor does not get warm.	Cable has been damaged.	Measure cable resistance. Check for both “open circuit” and “short circuit” as detailed earlier in this manual. If damaged, record resistances between all wires and contact the manufacturer.
	GFCI has tripped, indicated by a light on the control or “GFCI TRIP”.	Check for loose wire connections. Reset the GFCI on the control or circuit breaker. If it trips again, check for a short circuit in the cable as detailed earlier in this manual. If cable is damaged, record resistances between all wires and contact the manufacturer. If cable is not damaged, replace the GFCI control. Also see “GFCI conflicts” below.
	Incorrect voltage supplied, or mismatched electrical components used.	Measure “line” voltage, 120 VAC cables have black and white leads. 240 VAC cables have black and blue leads.
	Uninsulated concrete slab floor.	Surface temperatures rise slowly on an uninsulated slab and heat is lost to the ground below. If, after 5 to 8 hours of heating, the floor is not warmer to the touch, check for cable damage (see “Cable has been damaged” above). Measure “load” voltage/ amperage to cable.
	Cables are wired in “series” or “daisy chained” (end-to-end).	Multiple cables must be connected in “parallel” (or black-to-black, white-to-white).

<b>Problem</b>	<b>Possible Cause</b>	<b>Solution</b>
Floor heats continuously.	Incorrect wiring. The control was “bypassed” when it was wired to the power supply.	Make sure wiring connections are correct. Consult the wiring diagram on the back of the control, the instructions that came with the control, or the wiring diagrams in the Appendix.
	Defective control.	Return control to dealer for replacement.
Control is not working correctly.	If a programmable control, the programming may be incorrect.	Carefully read and follow control programming instructions.
	Incorrect voltage supplied, or mismatched components used.	Test voltage, verify parts. See “Incorrect voltage supplied” section
	Floor sensor is not wired properly, or is not working properly.	Make sure only one floor sensor is connected to the control.
	Loose connection(s) on line side and/or load side of control.	Remove and reinstall the wire nuts at each connection. Make sure the wire nuts are tight. Check all connections back to the breaker.
	Defective control.	Return control to dealer for replacement.
Control is not working at all.	No power is supplied.	Check circuit breaker. Measure voltage at the control. Check all connections between breaker and control.
	Floor sensor is not wired properly, or is not working properly.	Make sure only one floor sensor is connected to the control.
	Defective control.	Return control to dealer for replacement.
GFCI conflicts and false-trips.	An electric motor or a ballasted light source is sharing the circuit with the cable(s).	Electric motors and similar electrical devices can cause a GFCI to false-trip. Run a dedicated circuit to the floor-warming system or select a different branch circuit.

Although this troubleshooting guide is provided to assist with problems experienced with a floor-warming system, results are never guaranteed. The company does not assume any liability or responsibility for damage or injury that may occur from using this guide.

If problems with the system persist, call the manufacturer.

WARNING: This product contains chemicals known to the State of California to cause cancer and birth defects or other reproductive harm. For more information: [www.watts.com/prop65](http://www.watts.com/prop65)

## Electric Floor-warming Products 25-year Limited Warranty

SunTouch and Watts Radiant (the Companies) warrant their respective electric floor heating mats and cables (the Products) to be free from defects in materials and workmanship for twenty-five (25) years from the date of manufacture. Thermostats and controls sold by the Companies are warranted, parts and materials, for two (2) years from the date of purchase. The sole remedy for controls is product replacement. This warranty is only provided to customers who purchase the Products from authorized resellers, and is transferable to subsequent owners of properties where the Products are initially installed.

### Under this Limited Warranty, the Companies will provide the following:

If the Product is determined by the Companies to be defective in materials and workmanship, and has not been damaged as a result of abuse, misapplication or modification, the Companies will refund all or part of the manufacturer's published list price of the Product at the time of purchase in accordance with the following: 100% for the first ten (10) years, then prorated on a diminishing 25-year scale for the remaining warranty period.

### For example:

- (1) Product found defective in the 5th year will receive the full manufacturer's published list price of the Product at the time of purchase;
- (2) Product found defective in the 15th year, with 10 years remaining in the warranty period, will receive 10/25ths of the manufacturer's published list price of the Product at the time of purchase.

### In order to make a claim, you must:

- (a) Provide the Company with sufficient details relating to the nature of the defect, the installation, the history of operation, and any repairs that may have been made.
- (b) At the Company's discretion and at the owner's expense, ship the Product to the Company or the Company's local representative or distributor.
- (c) Provide proof that the Product was installed in accordance with the applicable Product Installation Manual and any special written design or installation guidelines by the Companies for this project.
- (d) Provide proof that the Product was installed in accordance with the National Electrical Code (NEC) or the Canadian Electrical Code (CEC), and all applicable local building and electrical codes.
- (e) Provide a retail sales receipt or proof of purchase.

### The following are not covered by this Limited Warranty:

- (a) Any incidental or consequential damage, including inconvenience, loss of time or loss of income.
- (b) Any labor or materials required to repair or replace the Product or control, not authorized in writing by the Company.
- (c) Any labor or materials required to remove, repair or replace flooring materials.
- (d) Any freight or delivery costs related to the Product, the control, or any related flooring or electrical products.

The Companies assume no responsibility under this warranty for any damage to the Product caused by any trades people, visitors on the job site, or damage caused as a result of post-installation work. The staff at the Company is available to answer any questions regarding the proper installation or application of the Product at this toll-free phone number: 800-276-2419. If you are ever in doubt about the correct installation procedure to follow, or if the Product appears to be damaged, you must call us before proceeding with the installation, or proposed repair.

THE COMPANIES DISCLAIM ANY WARRANTY NOT PROVIDED HEREIN, INCLUDING ANY IMPLIED WARRANTY OF MERCHANTABILITY OR IMPLIED WARRANTY OF FITNESS FOR A PARTICULAR PURPOSE. THE COMPANIES FURTHER DISCLAIM ANY RESPONSIBILITY FOR SPECIAL, INDIRECT, SECONDARY, INCIDENTAL, OR CONSEQUENTIAL DAMAGES ARISING FROM OWNERSHIP OR USE OF THIS PRODUCT, INCLUDING INCONVENIENCE OR LOSS OF USE. THERE ARE NO WARRANTIES WHICH EXTEND BEYOND THE FACE OF THIS DOCUMENT. NO AGENT OR REPRESENTATIVE OF THE COMPANIES HAS ANY AUTHORITY TO EXTEND OR MODIFY THIS WARRANTY UNLESS SUCH EXTENSION OR MODIFICATION IS MADE IN WRITING BY A CORPORATE OFFICER.

DUE TO DIFFERENCES IN BUILDING AND FLOOR INSULATION, CLIMATE, AND FLOOR COVERINGS, THE COMPANIES MAKE NO REPRESENTATION THAT THE FLOOR TEMPERATURE WILL ACHIEVE ANY PARTICULAR TEMPERATURE, OR TEMPERATURE RISE. UL® STANDARD LISTING REQUIREMENTS LIMIT THE HEAT OUTPUT OF REGULAR MATS AND CABLES TO 15 WATTS PER SQUARE FOOT DEPENDING ON CABLE INSTALL SPACING, AND UNDERFLOOR MATS TO 10 WATTS PER SQUARE FOOT, AND AS SUCH, USERS MAY OR MAY NOT BE SATISFIED WITH THE FLOOR WARMTH THAT IS PRODUCED. THE COMPANIES DO WARRANT THAT ALL PRODUCTS WILL PRODUCE THE RATED OUTPUT LISTED ON THE PRODUCT NAMEPLATE, WHEN OPERATED AT THE RATED VOLTAGE.

Some states do not allow the exclusion or limitation of incidental or consequential damages and some states do not allow limitations on how long implied warranties may last. Therefore, the above limitations or exclusions may not apply to you. This warranty gives you specific legal rights and you may also have other rights, which vary from state to state. SO FAR AS IS CONSISTENT WITH APPLICABLE STATE LAW, ANY IMPLIED WARRANTIES THAT MAY NOT BE DISCLAIMED, INCLUDING IMPLIED WARRANTIES OF MERCHANTABILITY OR FITNESS FOR A PARTICULAR PURPOSE ARE LIMITED IN DURATION TO TWENTY-FIVE YEARS FROM THE DATE OF MANUFACTURE.

### Terms and Conditions

**Shipping Discrepancies:** Incoming materials should be inventoried for completeness and for possible shipping damage. Any visible damages or shortages must be noted prior to accepting the material. Once the receiving personnel accept the material on their dock, they have relieved the freight company of any responsibility. Any discrepancy concerning type or quantity of material shipped, must be brought to the attention of the Companies within 15 days of the shipping date entered on the packing slip for the order.

**Return Policy:** The Companies items may be returned within one year from the date of purchase, if they are not damaged or used. There will be a 15% restock charge applied to items returned due to overstock or customer order error. All returned items must be in new condition. Products, controls or other parts that have a quality defect will be replaced (not credited) at no charge to the customer. If an item is shipped in error, there will be no restocking charge. All items returned, for replacement, credit or repair, must have a Returned Goods Authorization (RGA) number, or they will not be accepted. Please call our order desk for an RGA number. Products older than one year are excluded from these terms and conditions and may not be returned. No returns will be accepted for the Custom TapeMat product. Products that have been damaged, or Products that have been cut, may not be returned. This includes Products that have had mortar or concrete materials applied to them. These Products cannot be repaired and cannot be resold; therefore, we cannot accept them.

**Effective:** APRIL 1, 2006. This warranty applies to all Products purchased after this date.

## Affiliations:



Success By Association®



The SunTouch and Watts Radiant manufacturing facility's Quality System is an ISO 9001:2008 registered facility through LRQA.

### SunTouch Customer Support

USA Toll-free: (888) 432-8932

USA Fax: (417) 831-4067

Canada Toll-free: (888) 208-8927

Canada Fax: (905) 332-7068

Latin America Tel: (52) 81-1001-8600

Latin America Fax: (52) 81-8000-7091

SunTouch.com

### Watts Radiant Customer Support

USA Toll-free: (800) 276-2419

USA Fax: (417) 864-8161

WattsRadiant.com

Canada Toll-free: (888) 208-8927

Canada Fax: (905) 332-7068

Watts.ca

