

CONTENTS

1. Safety Instructions P1

2. What's in the Box P4

3. Using Your X500 P5

Important Tips before Use P5

Preparation P6

LED Indication P8

Charging Modes P8

Switching Modes P9

Cleaning Modes P10

Set Time and Scheduled Cleaning P11

4. Cleaning and Maintenance P12

X500 Anatomy P12

Clean the Rolling Brush P13

Replace the Side Brushes P13

Clean the box and Filters P14

Replace the Side Brushes P15

Clean the Sensors and Charging Terminals P15

5. Troubleshooting P16

6. Specification P17

7. Customer Service P17

1. Safety Instructions

To reduce the risk of injury or damage, read these safety instructions carefully and keep them at hand when setting up, using, and maintaining this device.

Safety Instructions for X500 and Accessories

⚠ Warning

1. Do not disassemble, repair or refit the product without authorization; otherwise, it may damage the product or pose a hazard.
2. Do not use the device in an environment with a risk of fire or explosion.
3. This device is only to be used with the original power adapter; otherwise, it may be damaged or catch fire.
4. This device is not a toy. Do not sit or stand on this device. Small children and pets should be supervised when this device is operating.
5. If the metal part of the power plug is dusty, please wipe it with a dry cloth.
6. The power adapter is applied to a 100-240V AC voltage. Please plug it into the socket properly and keep away from children.
7. Do not wash or soak the main body and electronic accessories in water; otherwise, the device may be damaged by a short circuit.
8. Do not damage, load weight on, heat, pull, or bend it.
9. During cleaning, please pay attention to the safety of toddlers and the elderly at home to avoid tripping, and to avoid injury please do not touch the wheel and side brush. (Please pay special attention to toddlers).
10. This device is for indoor use only. Please do not use it outdoors.
11. Do not allow metal and conductive materials to come in contact with the battery. It may result in a short circuit.

ⓘ Attention

1. Do not touch the device with wet hands. It may result in an electric shock.
2. Do not place the device where it could easily fall, such as on tables, chairs, high platforms in room, etc.
3. The device has a sophisticated design and should be protected from long-term exposure to sunlight.
4. Do not use the device in humid environments, such as bathrooms.
5. Do not place the device near cigarette butts, lighters or open fires.
6. Clean the product at the end of charging.
7. Please turn off the power switch on the side of the robot when it is out of service for a long time.

8. Before using the device, please remove all vulnerable items on the floor, such as glass, lamps, and items such as wires and curtains that may become entangled with the side brush and suction passages.
9. When the dust box is full, please empty it into the garbage before using it again.
10. Do not use the robot to clean construction waste.
11. The operating temperature of the device ranges from 0 degrees Celsius to 40 degrees Celsius; please do not use it in a high-temperature environment.
12. Before the device is scrapped, please remove the battery from the robot. When you remove the battery, please ensure that the device is not connected to a power supply. Please recycle the battery safely for environmental protection.

Safety Instructions for X500 and Accessories

⚠ Danger

1. Always use a dedicated battery adapter to avoid leakage, heating or rupture.
2. Do not short-circuit the battery or remove the battery. It may result in leakage, heating or rupture.
3. Do not transport or preserve with necklaces, hairpins and other metal objects. It may result in a short circuit, leakage, heating or rupture.
4. Do not burn or heat the battery. It may result in leakage, heating or rupture.

⚠ Warning

1. When skin or clothing is exposed to the battery electrolyte, please immediately wash with clean water to avoid inflammation of the skin, etc.
2. Do not use the rechargeable battery on other devices. This battery is only suitable for the Tesvor robot vacuum cleaner.
3. If the battery's outer box is found to be deformed and enlarged, or there is a leakage of electrolytes, do not charge or continue to use to avoid danger.
4. Do not throw or inflict a strong impact on the battery. It may result in leakage, heating or rupture.
5. Do not disassemble the battery pack. It may result in battery rupture and electrolyte outflow, leading to fire, explosion, and other dangers.
6. This device can be used by children aged 8 years and above and persons with reduced physical, sensory or mental capabilities or lack of experience and knowledge if they have been given supervision or instruction concerning the use of the device in a safe way and understand the hazards involved.
7. Children should be supervised to ensure they do not play with this device.
8. Cleaning and maintenance must not be performed by children without adult supervision.
9. This device contains batteries that can only be replaced by skilled people.
10. Only use the detachable supply unit provided with this device to recharge the battery.

11. The power supply must be removed from the socket-outlet before cleaning or maintaining the device.
12. The battery must be removed from the device before it is scrapped.
13. The device must be disconnected from the mains supply when removing the battery.
14. The battery should be disposed of safely.
15. How to remove the battery:

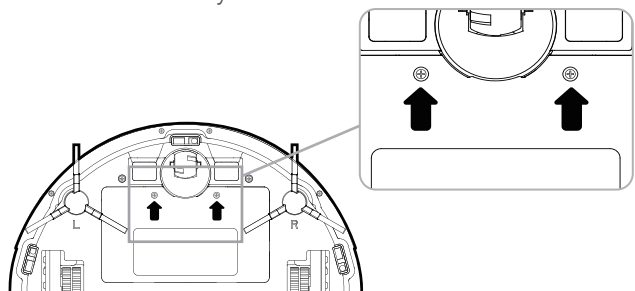

- ① Take out the two screws on the battery cover with a screwdriver.
- ② Take off the battery cover.
- ③ Take the battery out and unplug the electric wires to remove the battery.

⚠ Attention

1. If abnormal overheating is discovered during charging, stop using it immediately to avoid leakage, heating or rupture.
2. To prolong the service life of the battery, please remove the battery and place it in a cool, dry environment if it is out of service for a long time; this will avoid leakage, heating or rupture.
3. Do not soak the battery in water or let it come into contact with any liquid; otherwise, it may cause leakage, heating or rupture.
4. Be sure to stop using it immediately in case of any problem (e.g., discoloration or deformation), to avoid leakage, heating or rupture.
5. Always use tape to insulate the battery's electrode when recycling or disposing of it.

2. What's in the Box

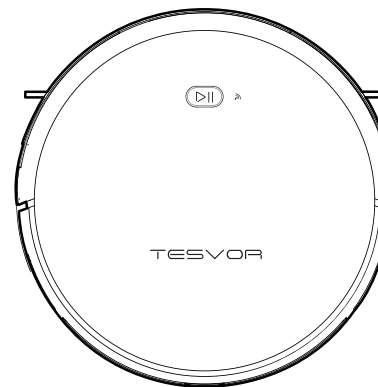

Main Body

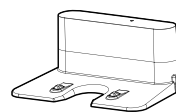

Charging Base



Remote Control
(2 * AAA Batteries required
but NOT included)

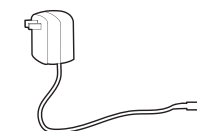

Power Adapter



Cleaning Tool

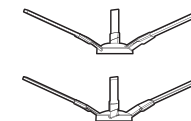

Side Brushes(4)

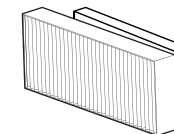

High-effective
Filter/Sponge

While the accessories provided for some models are slightly different, they are subject to the actual product.

3. Using Your X500

Important Tips before Use

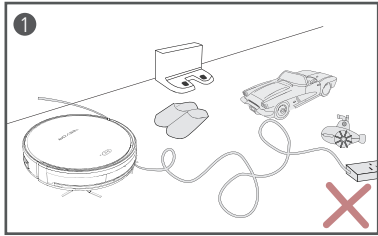

- 1 Remove power cords and small objects from the floor that may become entangled with the X500.
- 2 The X500 may climb on top of objects less than 0.63 in/16 mm in height. Remove these objects if possible.

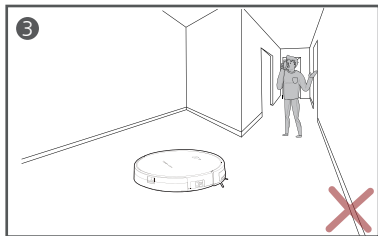
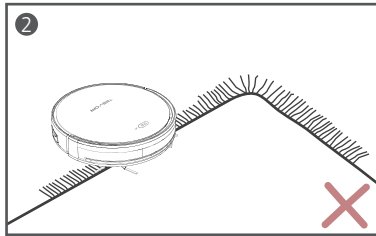

- 3 Do NOT stand around narrow places, such as thresholds and aisles, to reduce the uncovered rate.
- 4 The X500 will clear all memories and re-plan all work routes if it is manually moved or it is controlled by the remote control during cleaning. To ensure it works efficiently, please do NOT arbitrarily move X500 manually or operate it by remote control during cleaning.

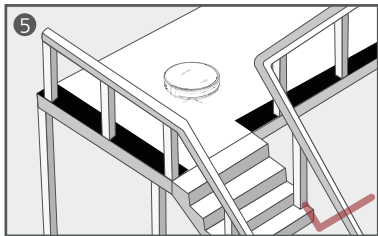
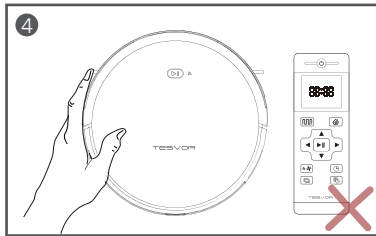

- 5 Anti-drop sensors prevent the X500 from tumbling down stairs and steep drops. They may work less effectively if they are dirty or used on reflective/very dark-colored floors. It is recommended that physical barriers are used to block off areas where the X500 may fall.
- 6 Please make sure all furniture is properly organized so that the X500 is able to clean well without becoming stuck.



Preparation

- 1 Install the side brushes before use. Please note L and R should correspond to each other when installing the side brushes.

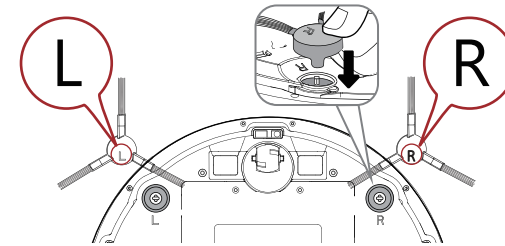

- 2 Turn on the main power switch on the side of X500.

Remove before use

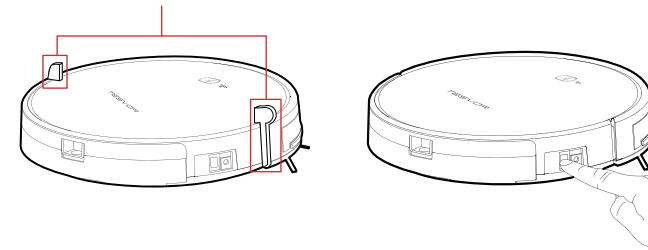

- 3 Place the Charging Base on a hard, level surface and against a wall.

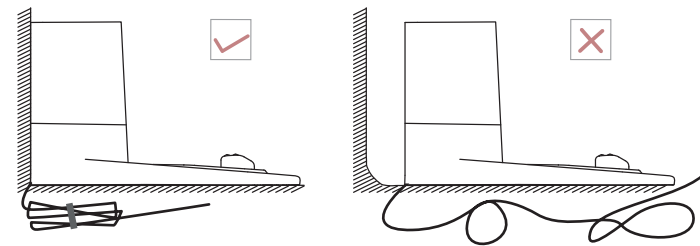

- 4 Do not place any objects within 3.3 ft. to the left / right and 6.6 ft. to the front of the charging base, and do not place any mirrors or other reflective objects within this range.

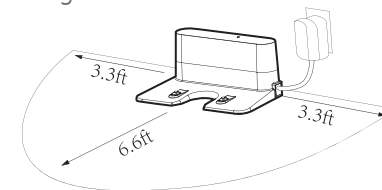

5 Install 2 AAA batteries (Not included in the package) into the remote control.

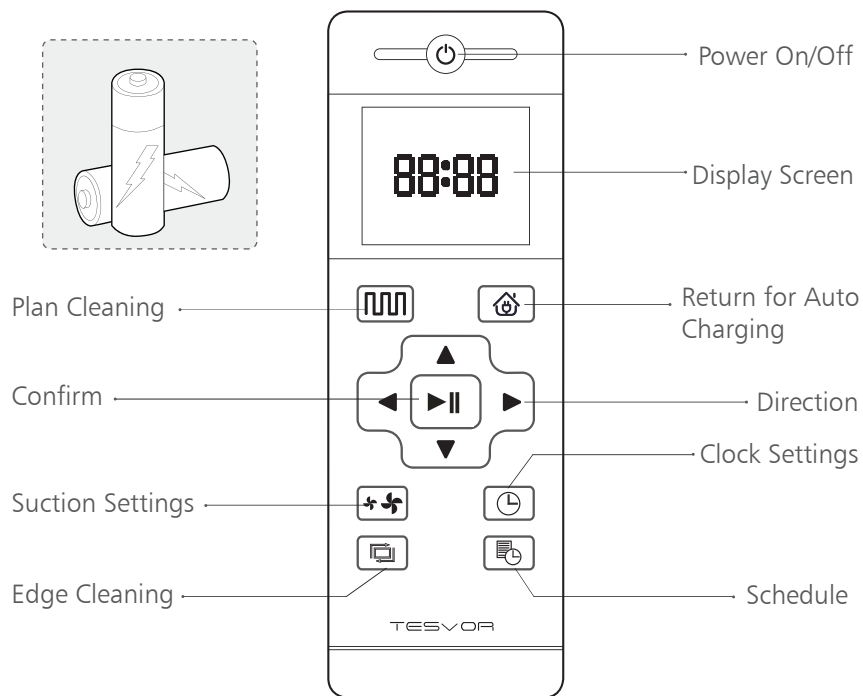

Note: For App users, please refer to our User Guide for App&Alexa.

When the device is in the vicinity of the charging base and the virtual protection wall, it may not be able to receive the instructions issued by the remote control. If you do not use the remote control for a long time, please remove the battery.

Direction Button

Under the standby mode, press this button to turn left/right, move forward/backwards and release it to return to the standby mode.

Under the Preset mode or the Time Settings mode, press this button to switch from hours to minutes.

Suction Settings

When you press [Plan Cleaning] on the remote control, you can see a fan sign appear on the screen. You can adjust the suction power by pressing [Suction Settings] on the remote control.

LED Indication

Indicator Light	Machine Status	Scene
Solid green 	Standby / Cleaning / Fully charged	The X500 is in Standby or Cleaning mode, or fully charged.
Flashing green 	Configuring mode	When connecting with the app
Solid orange 	Return for charging	Return for charging after cleaning finished
Flashing orange 	Return for charging	Low power and returning to Charging Base
	Recharging	Low power recharging
Off 	Sleep	The X500 is off. To conserve power, the light automatically turns off when the X500 has been inactive for 10 minutes.
Flashing / Solid red 	Error	The X500 has an error.

Charging Modes

Method 1: Press [Return for Auto Charging] on the remote control to return the X500 to the Charging Base.

Method 2: When cleaning is completed, or the battery is too low, the X500 will automatically start finding the charging base to charge itself. Please keep the charging base energized, or the X500 will not be able to find the charging base.

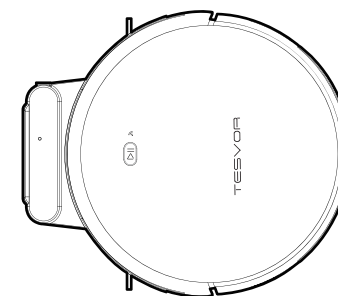
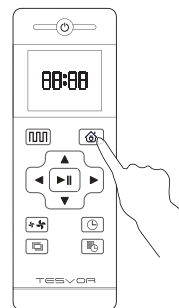

Switching Modes

Note: Make sure the power switch on the side of the X500 is turned on before use.



Wake Up

Sleep mode means that the X500 is stopped and the indicator light is off. If the X500 is not active for 10 minutes, it will enter Sleep mode automatically. Press  on the remote controller to wake it up.

Start

Under the Standby mode, press  on the X500 or  on the remote control to start the robot.

Pause

The pause function switches the X500 from the operating mode to the selected mode, and it can be paused by the following operations:

Press  on the remote control to pause it.

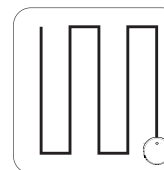

Note: If the X500 is out of service for a long time, please turn the power switch off.

Cleaning Modes



1. Smart Cleaning

The Tesvor X500 will perform the Smart Cleaning according to your home environment.

Click the **Smart Cleaning** icon  on the app or press  on the remote control to start cleaning under the Smart Cleaning mode.

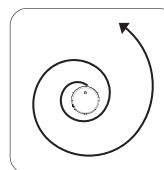

2. Spot Cleaning

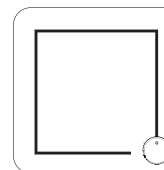

Tesvor X500 intensively cleans a specific area in a spiral pattern, useful if there is a concentrated area of dust or debris. When in the Spot Cleaning mode, the X500 will stop cleaning after 2 minutes.

Click the **Spot Cleaning** icon  on the app to start cleaning under the Spot Cleaning mode.



3. Edge Cleaning





The Tesvor X500 reduces its speed when it detects a wall and then follows the wall to ensure the edge is cleaned thoroughly.

Click the **Edge Cleaning** icon  on the app or press  on the remote control to start cleaning under the Edge Cleaning mode.

Set Time and Scheduled Cleaning

Set Time

Note: Make sure the time is set correctly to your local time before setting a scheduled cleaning.

1. Make sure the main power switch on the bottom of the X500 is turned on.
2. Press  on the remote control. The time will blink on the display.
3. Press     to set the "hour" and "minute".

Note: Make sure AM/PM is set correctly.



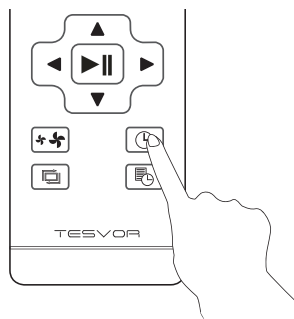



4. Press  to save the setting.



Set a Scheduled Cleaning

You can schedule the X500 to start cleaning at a specified time. To cancel a previously scheduled cleaning session, press and hold  for 3 seconds.

Note: Before setting a scheduled cleaning, make sure the time has been set correctly to your local time; refer to the previous section "Set Time" for how to set the time.

1. Make sure the main power switch on the bottom of the X500 is turned on.
2. Press  on the remote control.  will blink on the display.
3. Press     to set the "hour" and "minute".

Note: Make sure AM/PM is set correctly.

4. Press  to save the setting.

4. Cleaning and Maintenance

For optimal performance, follow the instructions below to clean and maintain the X500 regularly. The cleaning/replacement frequency will depend on the way you use the X500.

X500 Anatomy

Top & Side

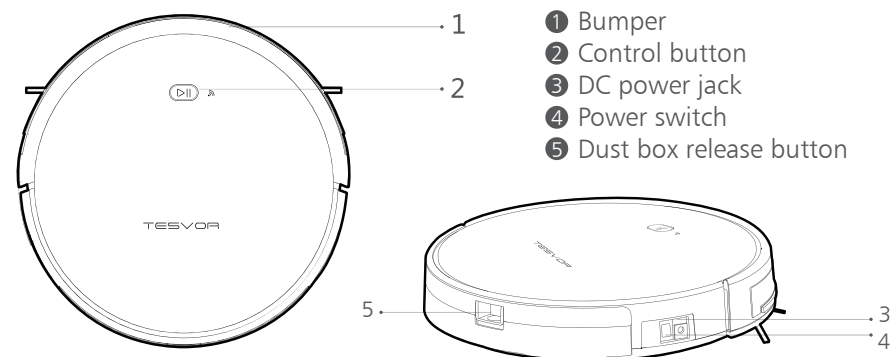

Bottom

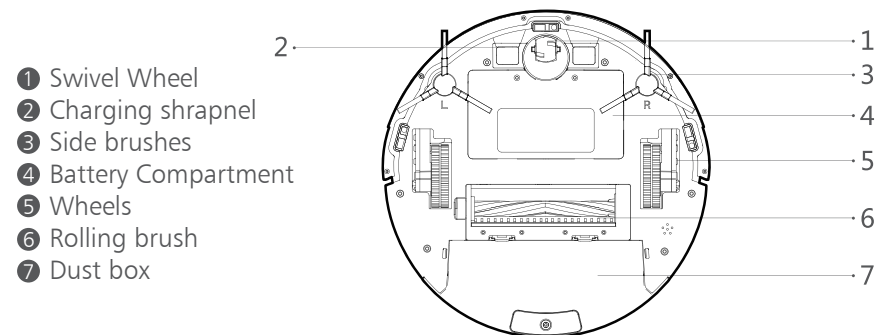

Charging Base

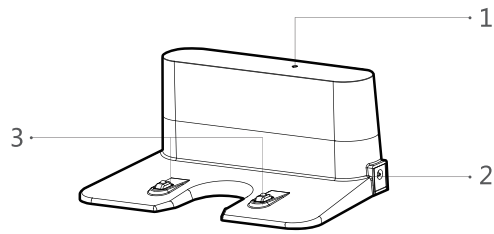

- ① Charging indicator light
- ② DC power jack
- ③ Charging terminal

Dust box

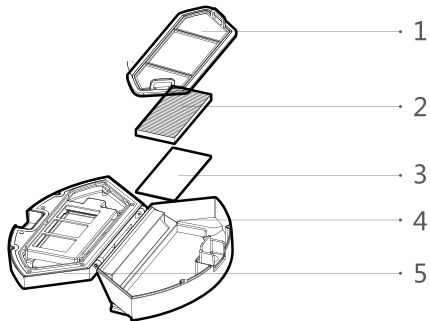

- ① Pre-filter
- ② High-performance filter
- ③ Filter sponge
- ④ Dust box
- ⑤ Dust box cover

Clean the Rolling Brush

1. Open the rolling brush components.
2. Remove the rolling brush shaft and clean off any debris and hair.

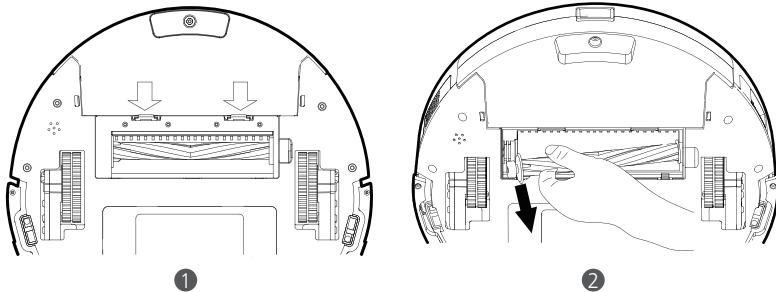

Clean the Side Brushes

Foreign substances, such as hair, can easily get tangled in the side brushes, and dirt may adhere to them. Be sure to clean them regularly.

- 1) Remove the side brushes.

- 2) Carefully unwind and pull off any hair or string that is wrapped between the main unit and the side brushes.
- 3) Use a cloth dampened with warm water to remove dust from the brushes or to gently reshape them.

Note: Only use the side brushes when they are completely dry.

Clean the box and Filters

1. Take out the dust box.

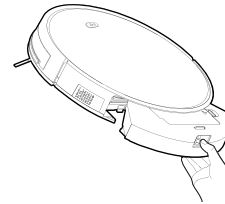

2. Clean up all dirt and dust in the box.

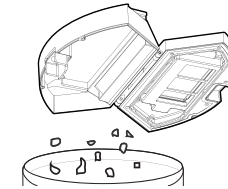

3. Take out the high-performance filter and the basic filter.

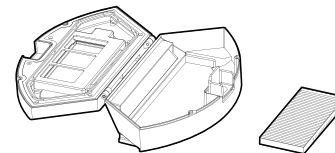

4. Clean up all dirt in the high-efficiency filter.

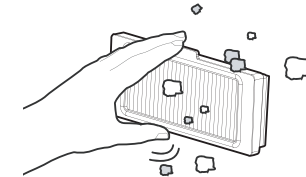

5. Clean the dust box and basic filter with water; Clean the high-efficiency filter with a brush.

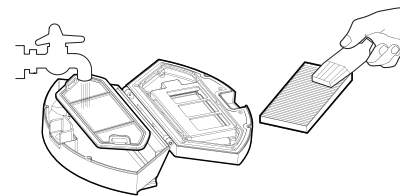

6. Dry the dust box, high-efficiency filter and basic filter in the sun.

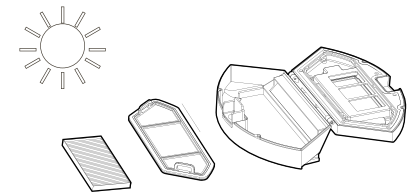

Note: You can wash the dust box, pre-filter and Filter sponge with water. Be sure to air-dry them thoroughly before reassembling. Do not wash the high-performance filter with water, as it may damage the filter and reduce the suction power.

Replace the Side Brushes

The side brushes may become bent or damaged after being used for a period of time.

Follow the instructions below to replace them.

Pull off the old side brushes and snap the new ones into place.

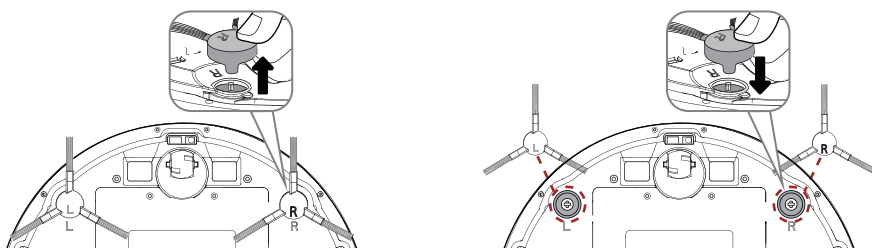

Clean the Sensors and Charging Terminals

To maintain the best performance, clean the drop sensors and charging terminal regularly.

Use a soft cloth or cleaning brush to clean the sensors and charging terminals periodically.

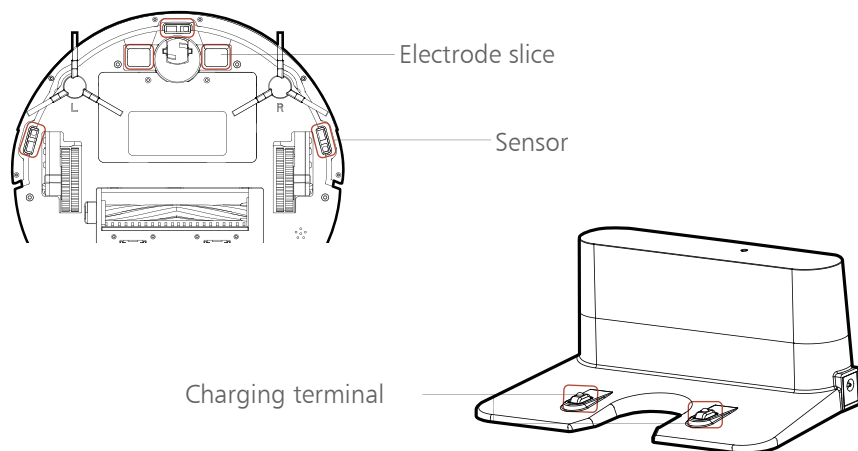

5. Troubleshooting

Frequently Asked Questions

Problems	Causes	Solutions
The X500's movements or travel path are abnormal.	There is something wrong with the X500's software.	<ul style="list-style-type: none"> Clean the sensors carefully with a dry cloth. Restart the X500 by turning the power switch off and back on.
The side brushes deform when you start cleaning the first time.	The side brushes are mounted in reverse.	Please install the side brushes correctly according to the marks L and R on the device.
The X500 doesn't keep working for 100 minutes.	The robot judge by itself that it has finished all the cleaning work and return for charging.	It is normal.
The X500 does not perform cleaning work automatically as scheduled on remote control.	<ul style="list-style-type: none"> Scheduling failed. The robot was restarted after scheduled. 	The remote control scheduling must be in a non-sleep state, and there is a voice prompt for the start and success of scheduling. In addition, the robot needs to be rescheduled after power off.
The X500 suddenly make noise.	The side brushes or rolling brush deform.	Remove the side brushes and the rolling brush separately to see if there are still any noise when working. If yes, confirm the problem accessory and replace it with a new one.

6. Specification

Product Model	X500
Input	19 V/ 0.6 A
Battery Voltage	DC 14.4 V
Power Consumption	25W
Battery Capacity	2500mAh
Dust Box Capacity	600ml
Cleaning Time	Max. 100 mins
Charging Time	240 - 360 mins
Diameter of main unit	330mm
Thickness of main unit	75mm
Net weight of main unit	3.0kg

7. Customer Service

If you have any issues, please contact us by Online Service on the app or send email to service@tesvor.com.