

# INSTALLATION

## Installation Parts and Tools

### Parts not Provided



Electrical cable

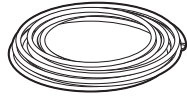

Water supply tube



Fittings for tube

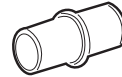

Coupler



Teflon™ tape

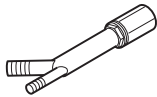

Air gap

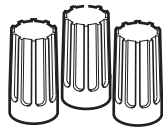

Wire nuts for 16-gauge wiring



Hose clamp

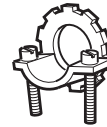

¾" UL approved strain relief

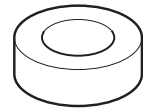

Electrical tape

### Tools Needed

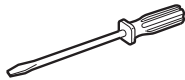

Flat-blade screwdriver



Phillips screwdriver

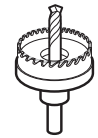

Hole saw min. 2½" bit



Electrical drill



Gloves



Safety glasses

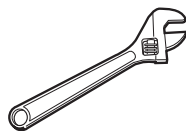

Adjustable wrench

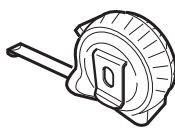

Tape measure

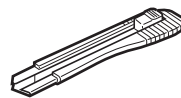

Utility knife

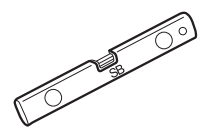

Level

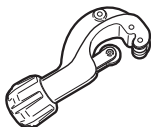

Tubing cutter



Nipper



Pliers

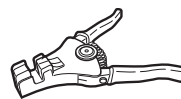

Wire stripper

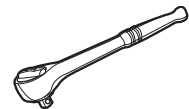

¼" Square drive wrench

## Installation Overview

- Preparing Cabinet Opening
- Preparing Electrical Wiring
- Preparing Water Supply Connection
- Preparing the Dishwasher
- Removing Lower Cover
- Sliding the Dishwasher into Cabinet

- Leveling the Dishwasher
- Securing the Dishwasher to Countertop
- Connecting the Drain Hose
- Connecting Water Supply
- Connecting Power
- Final Check

## Product Dimensions

Back view

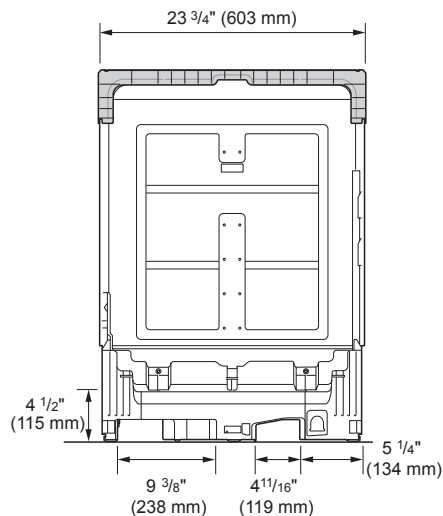

Side view

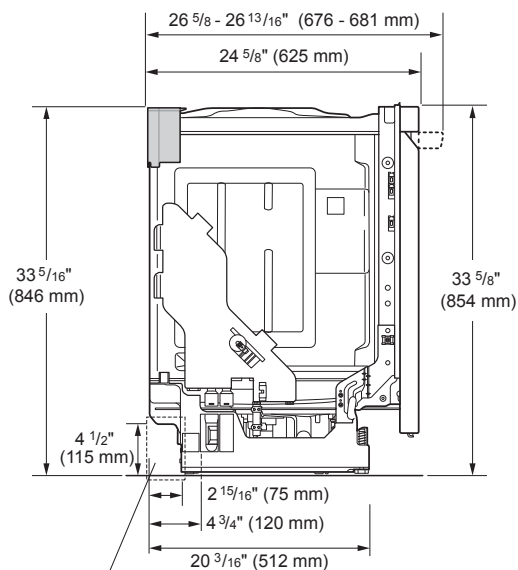

Water supply hose, drain hose and electric cable should be passed through this area.

### NOTE

- For easiest installation, see marked areas above for water and electrical clearances in base of dishwasher.

## Product Specifications

The appearance and specifications listed in this manual may vary due to constant product improvements.

<b>Electrical requirement</b>	120 V, 60 Hz AC only, minimum 15 A circuit breaker
<b>Water pressure</b>	20 - 80 psi (140 - 550 kPa)
<b>Dimensions</b>	23 3/4"(W) X 24 5/8"(D) X 33 5/8"(H) 603 mm(W) X 625 mm(D) X 854 mm(H)
<b>Inlet water temperature</b>	120 °F (49 °C) minimum, 149 °F (65 °C) maximum
<b>Net weight</b>	72 - 89 lbs. (33 - 40 kg)

## Preparing Cabinet Opening

This dishwasher is designed to fit a standard dishwasher opening. An opening may be needed on both sides to route plumbing and electrical connections.

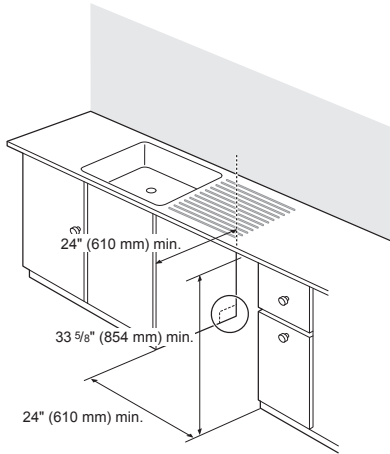

- 1 Select a location as close to the sink as possible for easy connections to water and drain lines.
- 2 To ensure proper drainage, install the dishwasher no more than 12 ft. (3.65 m) from the sink.
- 3 If installing the dishwasher in a corner, leave a minimum of 2" (50 mm) between the dishwasher and the adjacent wall.
- 4 To allow for proper clearance of plumbing and electrical, use the template included with the literature to determine the clearance on the side of the cabinet where the cabinet meets the back wall. Using a 2 1/2" diameter hole saw, drill a hole in the target area as shown on the template.

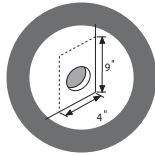
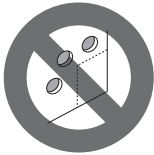

### NOTE

- Do not push.

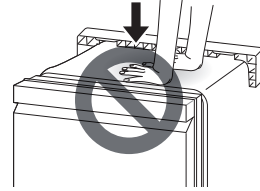

### ! WARNING

- Do not remove safety cover. Removal can result in fire, electric shock or death.

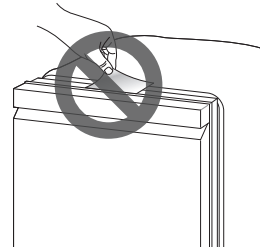

## Removing Lower Cover

- 1 Remove the two screws attaching the lower cover to the dishwasher.
- 2 Remove the lower cover from the base.
- 3 Remove the insulation pad from behind the access panel.

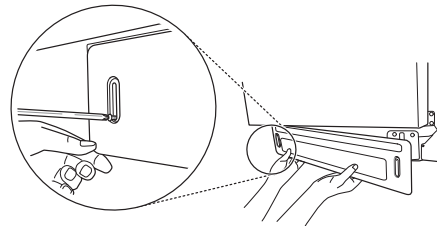

### ! CAUTION

- If you lay the dishwasher on its back, do so carefully to avoid damaging the drain hose and the tub.

### NOTE

- Remember to replace the lower cover when the installation is complete.

## Preparing Electrical Wiring

- 1 Operate this appliance with the correct voltage as shown in this manual and on the rating plate. Connect it to a dedicated, properly grounded branch circuit which is protected by a time delay fuse. Connect the appliance using 3-wires, including a ground wire.
- 2 If an outlet and other power connector are used, it should be in an accessible location adjacent to and not behind the dishwasher and within 4 ft (1.2 m) of the dishwasher's side.
- 3 The wiring must be grounded properly. If in doubt, have it checked by a qualified electrician. Do not connect any other appliance to the same outlet.
- 4 Route the wiring.

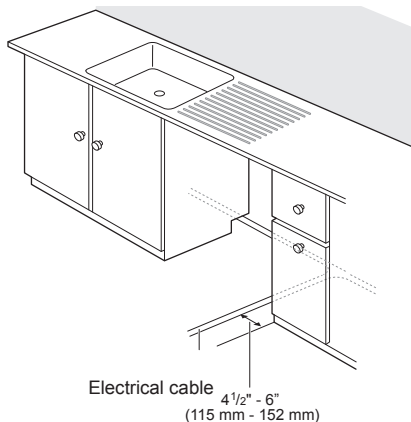

- 5 Make sure the electrical cable is oriented in the right side channel.

### **! WARNING**

- For personal safety, remove house fuse or open circuit breaker before installation.
- Do not use an extension cable or adapter with this dishwasher.

### **NOTE**

- If you find any damage to the dishwasher, contact your retailer or contractor.
- The included wire nut in 16AWG should be used.

## Preparing Water Supply Connection

Make sure the house water supply is turned off before connecting the dishwasher water lines.

- 1 Connect the dishwasher to a hot water supply with a temperature range between 120 °F (49 °C) and 149 °F (65 °C). This temperature range provides the best washing results and shortest cycle time. To prevent damage to dishes, the temperature should not exceed 149 °F (65 °C).
- 2 When connecting the dishwasher water line, sealing tape or compound should be used on pipe threads to avoid leaks. Tape or compound should not be used on compression fittings.
- 3 The water supply tube must be located in the left side channel.

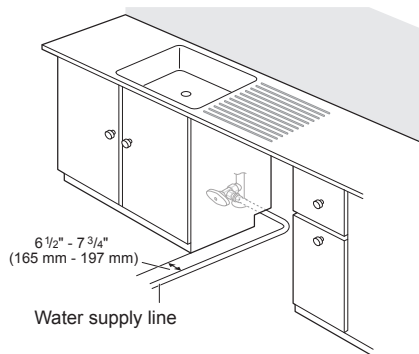

### **NOTE**

- Use new hoses when connecting to the water supply. Do not reuse old hoses.

## Preparing Dishwasher

### Removable Rear Plastic Shipping Brace

The rear shipping brace can be removed if additional clearance is needed when installing the dishwasher under a low countertop.

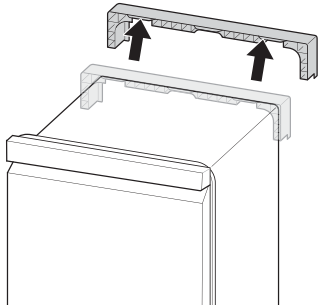

#### NOTE

- Do not pull or lift the dishwasher using the handle; doing so can damage the door and hinges. Open the door and grab the body frame and the top front opening of the tub to move or lift the dishwasher.

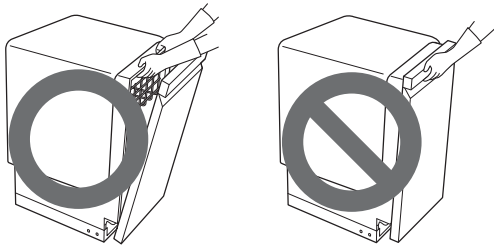

#### NOTE

- Do not push the door of the dishwasher with knees.

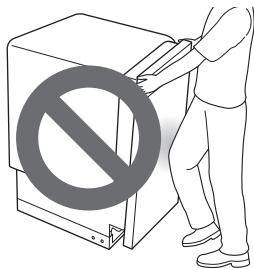

#### NOTE

- Do not push.

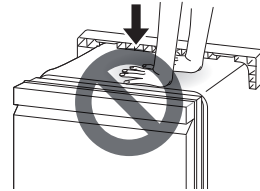

### ⚠ WARNING

- Do not remove safety cover. Removal can result in fire, electric shock or death.

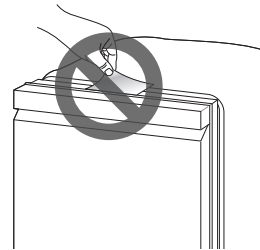

### Removing Lower Cover

- 1 Remove the two screws attaching the lower cover to the dishwasher.
- 2 Remove the lower cover from the base.
- 3 Remove the insulation pad from behind the access panel.

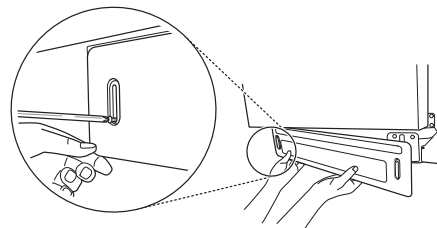

### ⚠ CAUTION

- If you lay the dishwasher on its back, do so carefully to avoid damaging the drain hose and the tub.

#### NOTE

- Remember to replace the lower cover when the installation is complete.

### Attaching Mounting Hardware

For countertops made of wood or other material that will not be damaged by drilling, use the metal installation brackets.

- 1 Insert the installation brackets into the slots in the upper frame.

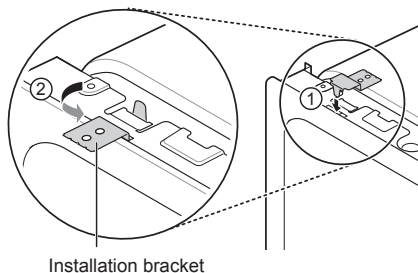

- 2 Bend the brackets to secure them to the dishwasher tub.

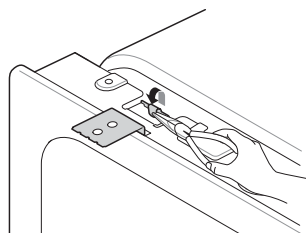

**NOTE**

- Installation brackets and screws can be found in the silverware basket.

For countertops made of granite, marble, or other materials that could be damaged by drilling, use the wood screws to attach the dishwasher to the cabinet. See installation instructions in Securing Dishwasher to Countertop.

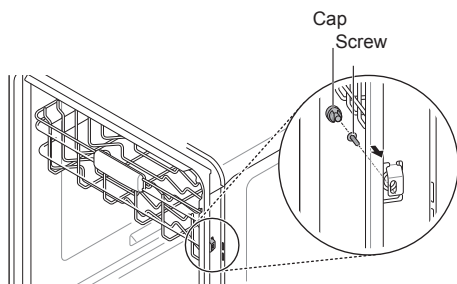

**! CAUTION**

- Ensure the dishwasher is level and all legs are in firm contact with the floor before attaching the dishwasher to the countertop or cabinet. If the product is not leveled properly, the door may not close or water may leak.

### Sliding Dishwasher into Cabinet

- 1 Slide the dishwasher carefully into the cabinet opening.
- 2 Make sure the drain hose inside the cabinet is not kinked or pinched.
- 3 Make sure the water supply line and electrical supply are routed through the channels under the dishwasher.
- 4 To avoid a kinked or pinched drain hose, be sure to pull on the drain hose while sliding the dishwasher into place. Do not allow any slack behind the dishwasher.

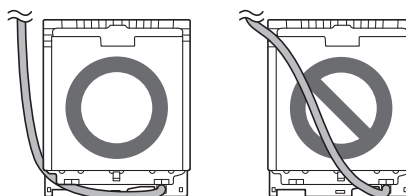

- 5 After leveling the dishwasher, do not leave the water supply line or power supply line under the base. This is a potential cause of water leaks. Place the water line and power supply line in the channel.

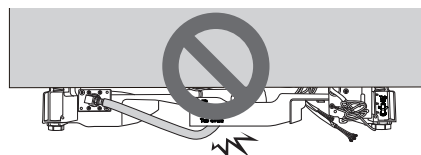

**! CAUTION**

- The opening in the side of the cabinet may have sharp edges. To avoid damaging the drain hose, smooth out or pad the edges of the opening. Pull the drain hose through the opening slowly and carefully.

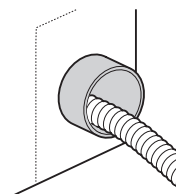

## Leveling the Appliance

Check that dishwasher is level.

- Attach level on top front opening of tub from side to side.
- Attach level on front side of tub.

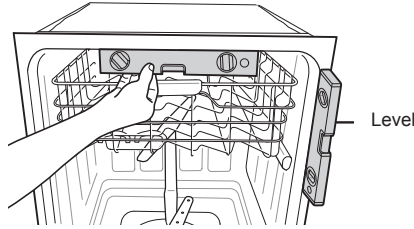

### NOTE

- If you don't have a level, try using a smartphone level application instead.

Make sure that the gap between the door and the tub is equal on both the left and right sides.

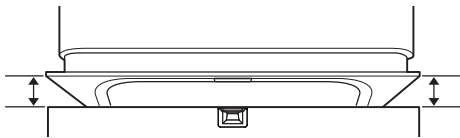

The water level should be checked after the initial fill on the Normal cycle. If the water level is not near the center of both tub lower indentations, the dishwasher may not be correctly leveled. The dishwasher may leak during operation if it is not correctly leveled.

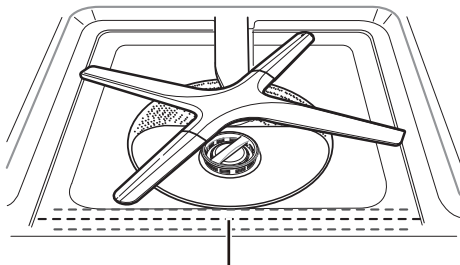

Water level should be near the center of both tub lower indentations.

## Adjusting the Legs

### Adjusting the Front Legs

- Use a flat-blade screwdriver or a pliers to turn the front legs and adjust the front of the tub.
- Turn the front legs clockwise to raise the front of the tub and counter-clockwise to lower it.
- The adjustments work identically for both front legs.

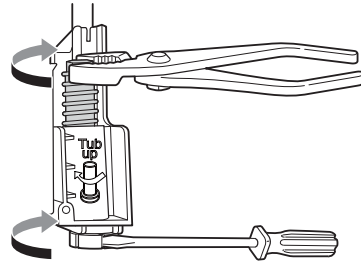

### Adjusting the Rear Legs

- Use a Phillips screwdriver to adjust the back legs and the rear of the tub using the center screw at the base of the appliance in the front.
- Turn the center screw clockwise to raise the rear of the tub and counter-clockwise to lower it.

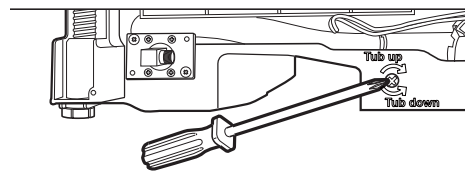

### NOTE

- To avoid damaging the screw, do not use an electric screwdriver.

## Securing Dishwasher to Countertop

For countertops made of wood or other material that will not be damaged by drilling, use Method 1.

For countertops made of granite, marble, or other materials that could be damaged by drilling, use Method 2.

### NOTE

- Cover the filter hole with towels to prevent screws from falling down into the pump.
- Use a magnetic screwdriver.

### Method 1

Using the provided screws, secure the dishwasher to the countertop through the holes in the bracket.

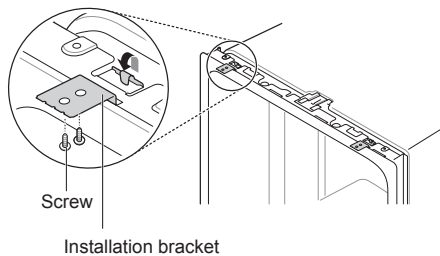

### NOTE

- Installation brackets and screws can be found in the silverware basket. See Attaching Mounting Hardware section for more information on attaching installation brackets to dishwasher.

### Method 2

- 1 Remove the plastic caps from the mounting bracket access holes.
- 2 Drive a wood screw through the mounting bracket and into the cabinet frame.
- 3 Reinstall the plastic caps.

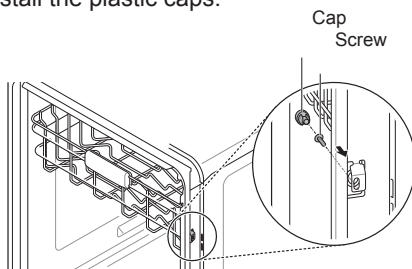

## Connecting Drain Hose

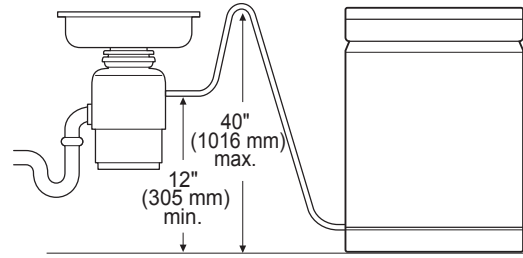

If the end of the drain hose does not fit the drain line, use a heat and detergent resistant adapter (not supplied). These may be obtained from a local plumbing supply store.

The two typical connections are shown. To prevent siphoning, one of the following connections should be used.

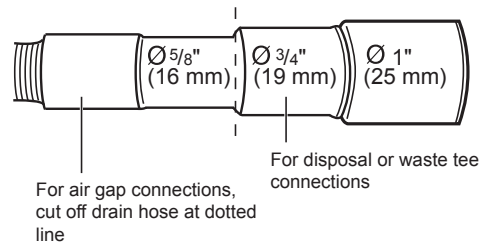

## Drain Requirements

- Follow local codes and ordinances.
- Do not exceed 12 ft. (3.65 m) distance to drain.
- Do not connect drain lines from other devices to the dishwasher drain hose.
- If an extension drain hose is required, use  $\frac{5}{8}$ " or  $\frac{7}{8}$ " inside diameter, 2-3 ft. length hose and a coupler for connecting the two hose ends.

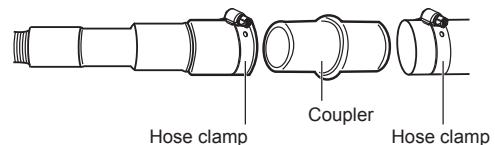

### NOTE

- For drain hose installation, use the screw style clamp provided with this dishwasher in the silverware basket.



**NOTE**

- If the knockout plug has not been removed, the dishwasher will not be able to drain properly.

**Connecting to Disposal with No Air Gap**

- 1 Remove the knockout plug with a hammer and screwdriver.

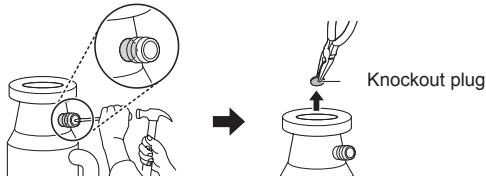

- 2 Attach the drain hose to disposal with the hose clamp provided. Move into position and tighten the hose clamp.

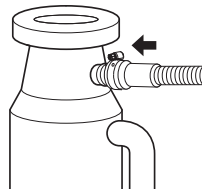

**Connecting Waste Tee with No Air Gap**

- 1 Remove the knockout plug with a hammer and screwdriver.

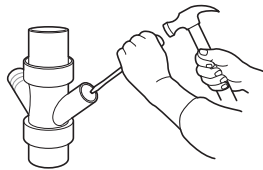

- 2 Attach the drain hose to waste tee with the hose clamp provided. Move into position and tighten the hose clamp.

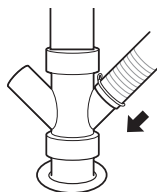

**Connecting to Disposal or Waste Tee with Air Gap**

- 1 Remove the knockout plug with a hammer and screwdriver.
- 2 Connect end of the drain hose to the air gap with hose clamp provided. This avoids water being siphoned from the tub.

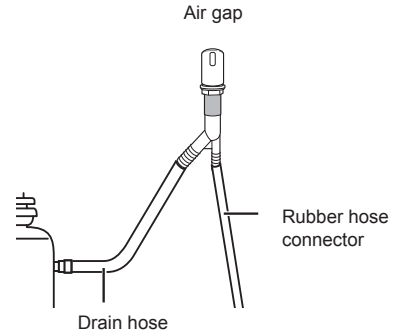

- 3 Attach the rubber connector to disposal or waste tee with the hose clamp provided. Move into position and tighten the hose clamp.

**Connecting without Air Gap**

The height of the drain hose end must be at least 12" (305 mm) and within 40" (1016 mm) from the base of the appliance to avoid water being siphoned from the tub.

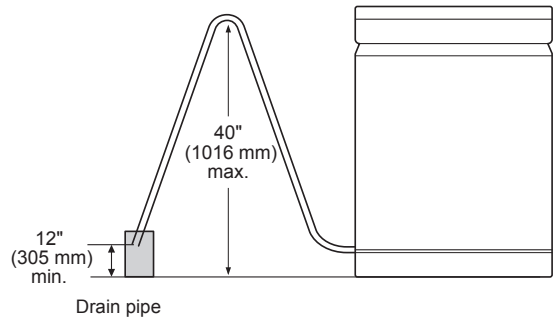

## Connecting Water Supply

- 1 Before connecting, turn off the water supply.
- 2 Slide the flexible stainless-steel water line or copper tube into the elbow.
- 3 Tighten the compression nut and make sure that the line is not kinked or pinched.

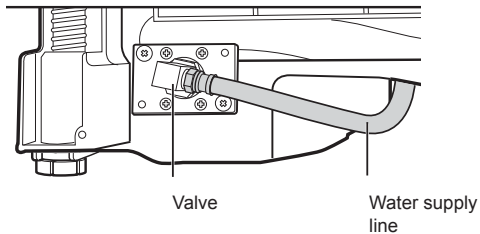

### NOTE

- During the final installation check of the dishwasher, an IE error code may appear on the display. Make sure the water line is not kinked and the water supply for the dishwasher has been turned on before calling for service.

## Connecting Power

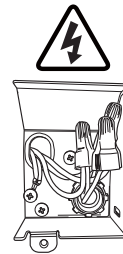

### NOTE

- The best location for the electrical conduit is on the right side of the back wall. Re-route the power cable before installation if the electrical conduit pipe is longer than 3" (76 mm) and is centered on the back wall.

- 1 Before beginning, turn off electrical power to the unit at the circuit breaker.
- 2 Remove the junction box cover and then install the strain relief.

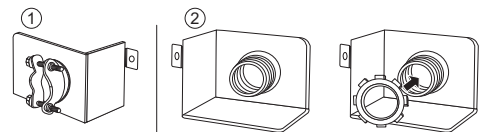

- 3 Twist the wire nuts tightly onto the wires; then wrap each connection with electrical tape.

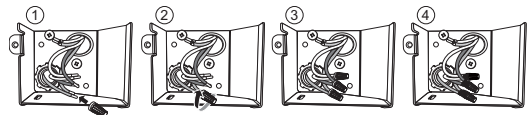

- 4 Check again and make sure that all wires are connected correctly: black to black, white to white, green ground wire to green ground wire.

- 5 Replace the junction box cover.

### ⚠ WARNING

- Verify that the black wire is hot (120 V). If not, or if you are unsure of the power supply, have it checked by a licensed electrician.

### ⚠ CAUTION

- Do not leave stripped wire exposed. Trim stripped wire to fit completely inside wire nuts.

## Final Check

- 1 Turn on electrical power.
- 2 Turn on house water supply.
- 3 Make sure the door opens and closes smoothly. If necessary, level the dishwasher again.  
If the door will not close, make sure the rack is level and all packaging materials have been removed.

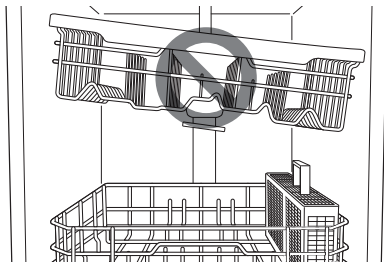
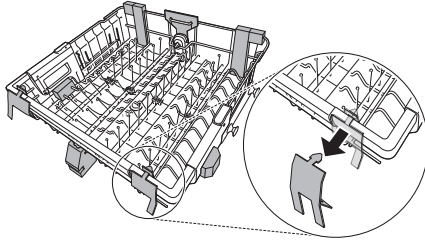

- 4 Run the dishwasher on a Turbo cycle to verify proper operation and check for leaks.

### CAUTION

- Only install the lower cover provided with the machine. Do not install cabinet baseboard as it may cause noise and leakage.

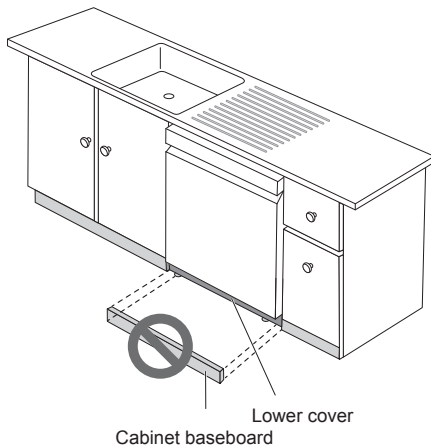

Error Code	Possible Cause and Solution
OE Error	<b>Drain hose kinked or pinched.</b> Feed the drainage and supply hoses through the hole under the sink. Then gradually slide the dishwasher into the cabinet while pulling on the hoses under the sink to take up any slack. This helps avoid kinking the hoses or trapping them beneath the dishwasher.
	<b>Drain hose connected to disposal.</b> Remove knockout plug on disposal.
	<b>Waste tee is clogged.</b> Remove knockout plug on waste tee.
IE Error	<b>Water supply line kinked under dishwasher.</b> Feed the drainage and supply hoses through the hole under the sink. Then gradually slide the dishwasher into the cabinet while pulling on the hoses under the sink to take up any slack. This helps avoid kinking the hoses or trapping them beneath the dishwasher.
	<b>House water supply not turned on.</b> Turn water on.