

Communicating Thermostat -

The CT80 has 2 RTM-1 radio ports. These allow your thermostat to communicate with other systems. Depending on your area Power Company, programs may be available to connect your thermostat to power grid status information. This can make it easy for you to moderate your energy use at peak hours and use power when it is less expensive.

The RTM-1 ports also allow you to connect your CT80 to your home WiFi network. This can give you access to your home's HVAC system even when you are away. It can also give you access to web based efficient energy management sites that can help you save money and protect the environment.

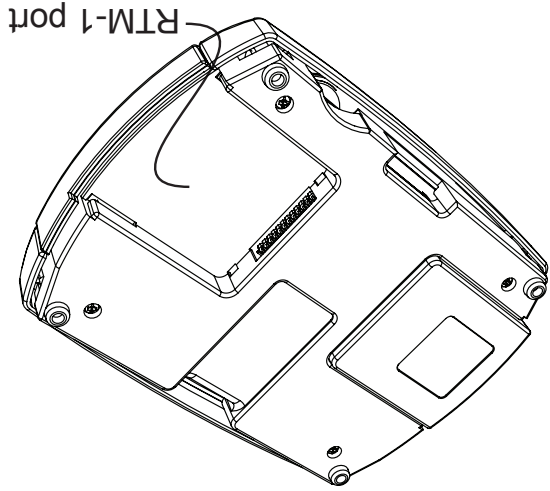

Customer support: 877-602-5028 or www.radiothermostat.com

1812-004-000

Printed in CHINA

Operation Guide CT80

Radio Thermostat

The CT80 programmable communicating thermostat operates via a high-quality, easy-to-use touch screen. To program or adjust your CT80, simply touch your finger or the stylus firmly to the screen. The screen will automatically light up and you will hear a “beep.” The screen will respond differently to different types of touches, so you may want to experiment with both your finger and with the stylus, which is included with the CT80, to see what works best for you.

Statement of use: 100% Compatible with all popular residential HVAC systems; 24VAC single, two, three stage conventional heating systems (gas/oil/electric), heat pumps (single and two stage compression) and single or two stage auxilliary heat (electric or fossil), zoned forced air and zoned hot water (2 or 3 wire), millivolt systems (with 24VAC adapter), one or two stage cooling, and hybrid systems.

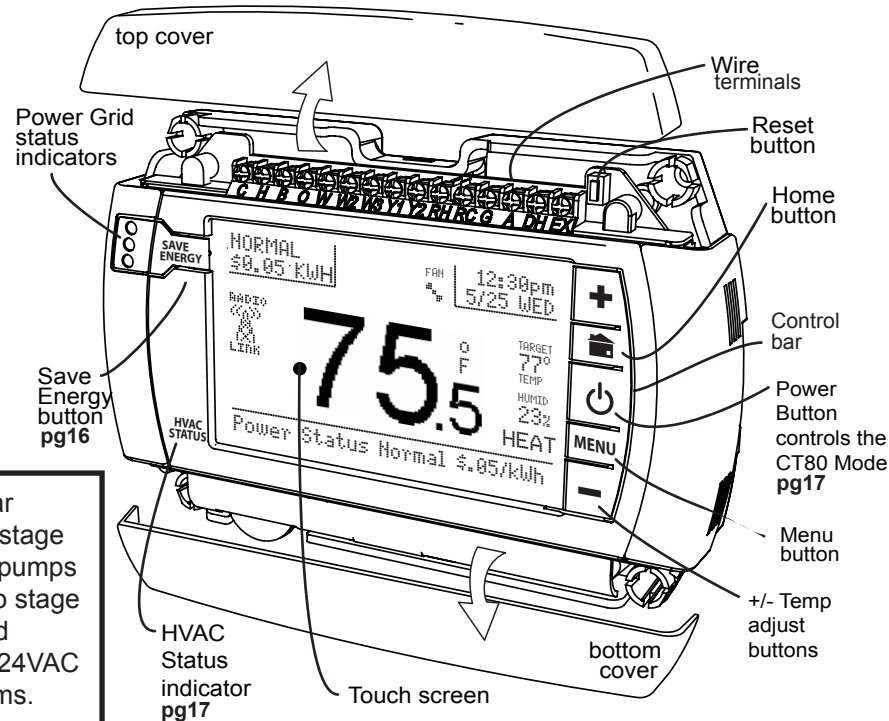

CONTROL SCREENS

Before you operate the CT80 please get familiar with these basic control screens. All the CT80 functions are accessed through these screens. HOME pg2, MENU pg3, and MANUAL pg4. The CT80 touch screen technology allows you to select (by touching) an item and change it using the +/- buttons on the control bar. All user inputs use this method. If you want to change it, touch it.

HOME Screen

The **HOME** screen is displayed when the unit is operating. Touching the green HOME icon  on the control bar will always return you to this screen.

To set a Mode:

Press the  Power button on the control bar. Touch the desired mode from the choices displayed at the bottom COOL, HEAT, AUTO or OFF.

Touch HOME when done.

Set the time by touching the hour or minute and the +/- buttons to change.

Your CT80 is now controlling your **HVAC**.

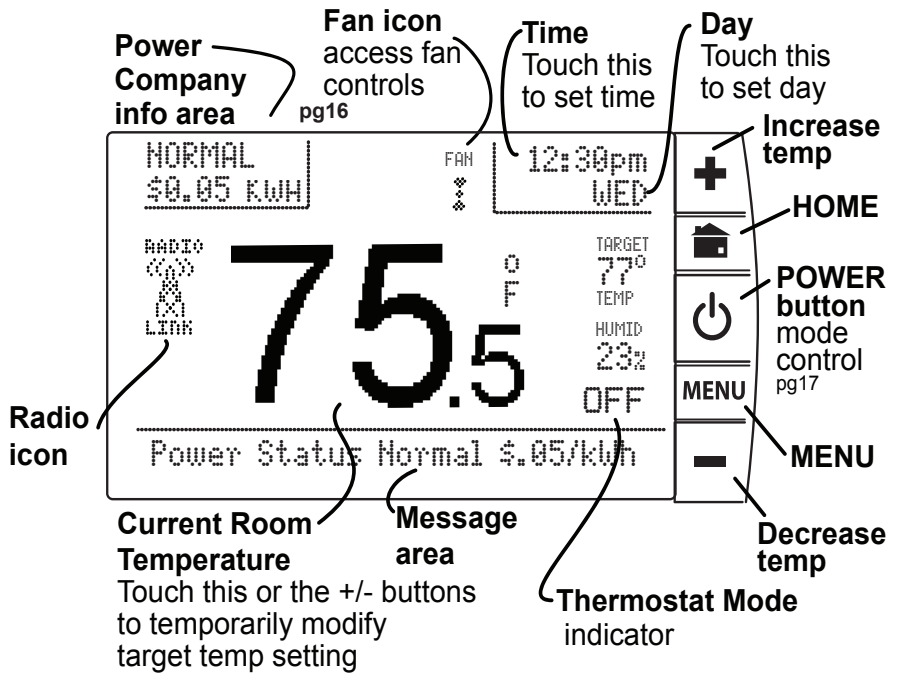

MENU Screen

The **MENU** screen is the gateway to many functions of the CT80. It is displayed when you press the purple MENU button on the control bar to the right side of the screen. Note page numbers for further info about each function.

Program

Use this to set a daily time/temp schedule (displayed in HEAT or COOL modes only)
pg6-7

Comfort setting

Use this to select efficiency or comfort
pg8

Humidity control

Use this to select MIN and Max humidity
pg10

Consumables

UV Bulb, Filter, and Humidifier pad reminders Timer set
pg11

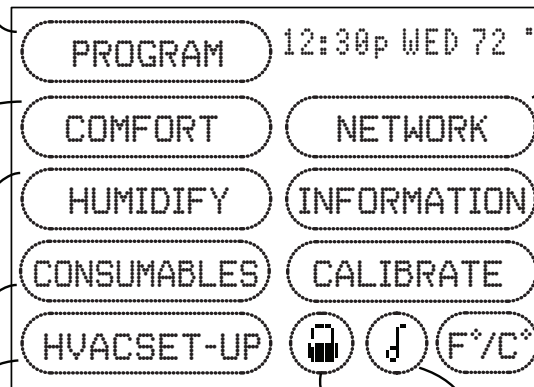

HVAC SET-UP

Use this to set your CT80 to control your HVAC system (displayed in OFF only)
pg12-13

Lock Control

pg14

Network control

Use this to configure network connections
pg14

Information access

Use this to access info screens from network connections
pg14

Calibration control

Use this to calibrate your LCD display match to another device
pg15

Set °F - °C

Touch this to set temperature display
pg9

Chirp set

Touch this to turn the audible chirp on or off
pg9

MANUAL Screen

The **Manual Screen** control screen is where you can make temporary changes to your CT80's operation. The CT80 has 6 manual override commands. These are accessed by pressing the +/- buttons or touching the current temperature on the HOME screen.

⚠ IMPORTANT: The Mode  must be in HEAT or COOL to access the manual screen.

Temporary OVERRIDE -

- Press the + / - buttons to select your desired temporary Target Temperature.
- Press HOME to return to operation.

The **TEMPORARY** icon will display indicating you have modified the Target Temperature for the current Time Slot only.

HOLD -

This will hold the target temperature you set indefinitely, until you turn it off. Take care using the **HOLD** function. To set a hold, touch **HOLD** to initiate a hold temperature. You can use the +/- buttons to select your hold temperature. The **HOLD** icon will display on the HOME screen indicating you have changed the Target Temperature. The system will **HOLD** this temperature until you return to this screen and de-select **HOLD**, by touching it. (HOLD is also canceled when you set the mode to OFF).

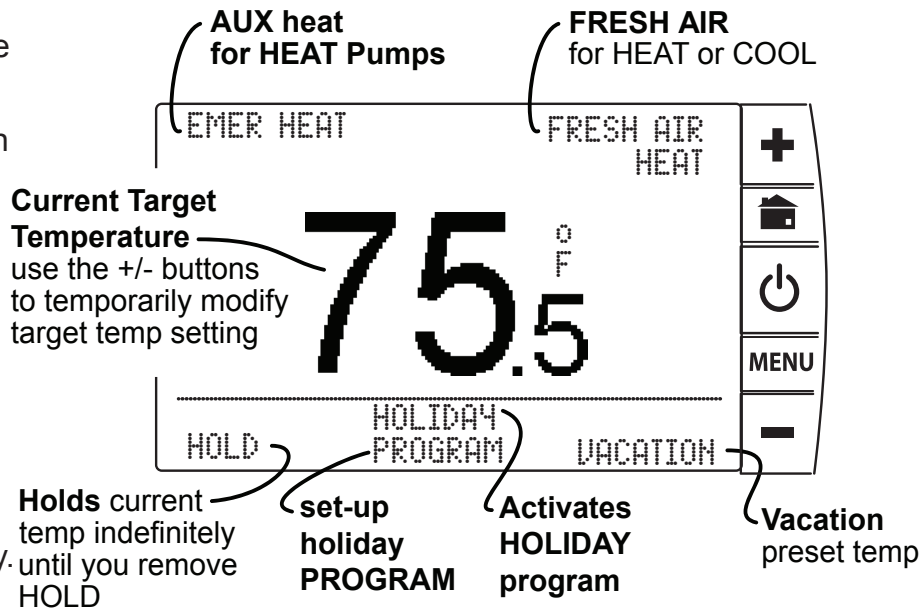

HOLIDAY PROGRAM - This is a single program that repeats day after day until you turn it off. It supersedes the weekly program. To modify it touch PROGRAM on the MANUAL screen. It uses the Calendar method for programming (see pg7).

VACATION - This function will hold a pre-set temperature until you turn it off. The preset is saved for next time.

FRESH AIR - If you have a fresh air baffle connected to the EX terminal, the CT80 will use this outside air source as the 1st stage of heating or cooling. Useful in desert climates where outside air temp can change very quickly or just to freshen indoor air quality.

EMER HEAT - This is available if you have a HEAT PUMP with auxiliary heat. When you select this your HEAT PUMP is disabled and auxiliary heat is your sole source of heat. This manual override setting stays active until you turn it off. (This command is not displayed if you do not have a heat pump). Remember auxiliary heat is more expensive than the heat pump.



Auto Run the pre-set program

The CT80 comes pre-programmed with an Energy-Star™ approved program. This program is recommended by the EPA for energy efficiency. We strongly recommend that you Auto-Run this program for one week, and see if it works for you. If it does not fit your needs you can always input a custom program.

- To Auto-Run the Energy-Star™ program, press  and select HEAT or COOL with the mode selection. Set the time and Day and Press HOME. The unit is now running the Energy-Star™ program.



MENU Functions

PROGRAM

The CT80 is designed for fast and easy programming with a simple, on-screen interview . Just answer the questions and the CT80 takes care of the rest. A calendar option is also available  for fine-tuning. HEAT and Cool are programmed separately.



Programming Using the Interview Method (Fastest and Easiest):

1. Make sure the CT80 is in either HEAT or COOL using the MODE button .
2. Press **MENU** on the control bar and then touch **PROGRAM** in the upper left of the screen. The **PROGRAM BY INTERVIEW** screen will come up.
3. Read each question and fill-in your answers by touching the answer in brackets $<78^{\circ}>$ to highlight and using the +/- buttons to adjust. (Press and hold +/- buttons for faster scrolling)
4. Touch  (the scroll down) arrow in the lower right corner of the screen to go to the next set of questions and continue answering. Use  (scroll up) to go back to a previous question.
5. Once the interview is complete, press **HOME** to return to the Home screen. If you want to change entries just go back to step 1 and modify your answers.

INTERVIEW SCREEN

Scroll control

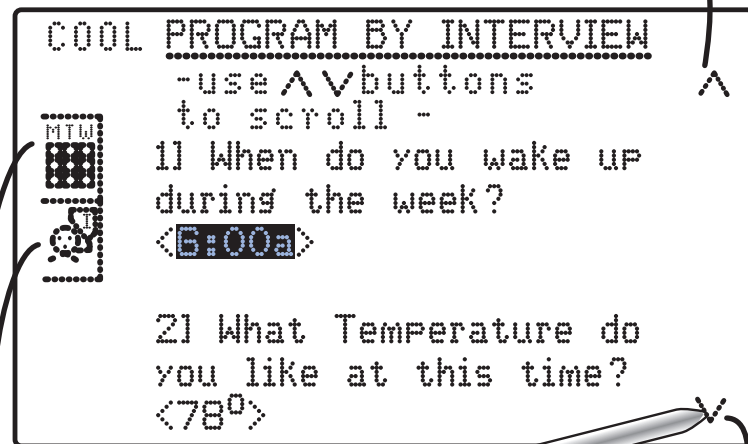

Interview
Calendar

Scroll control

The CT80 will generate a simple program for you. It will assume you are home on the weekend and just apply your wake-up and evening temp choices. Your CT80 is now programmed and ready to go. No additional updates are needed. If you would like to fine-tune the CT80 programming, including adding or deleting time periods, or reviewing your schedule, please refer to the instructions that follow regarding programming using the Calendar method.



Calendar Programming Method -

You can use the Calendar screen to review your current CT80 schedule, or to make changes after programming in Interview mode. To create a whole new program: (With the CT80 in HEAT or COOL mode)

1. Press MENU and then touch PROGRAM in the upper left of the screen.

2. Touch the CALENDAR icon  on the left side of the screen. A schedule of times slots with temperatures for today will appear on the screen.

3. Select a time period or temperature by touching it, and use the +/- buttons to adjust up or down. (Press and hold down +/- buttons for faster scrolling.)

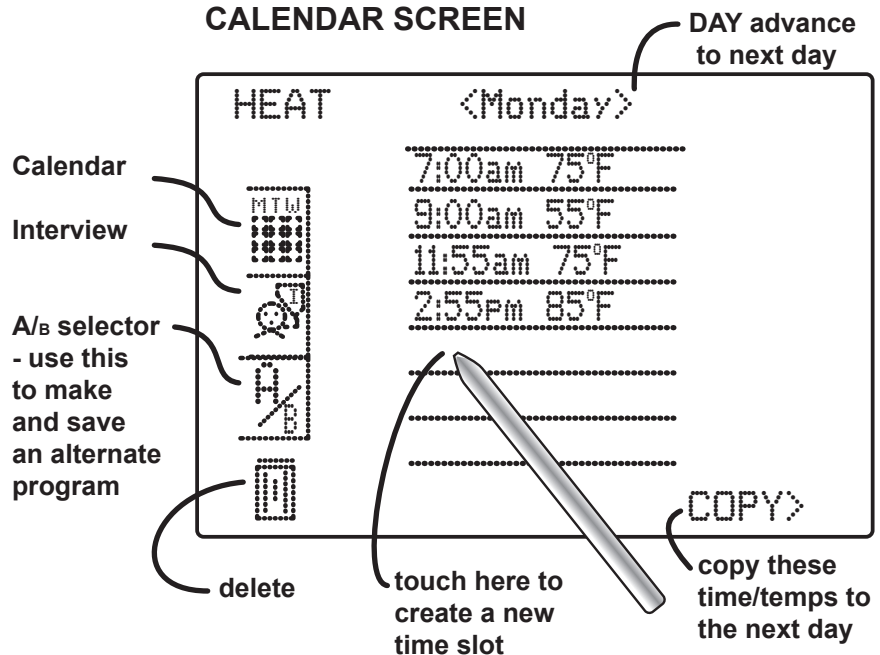

PROGRAM

cont.

4. You can ADD additional time slots (up to seven in a day) by touching a blank line, and then adjusting the time and temperature with the +/- buttons. To DELETE a time slot, highlight and then touch the TRASH CAN icon in the lower left of the screen .
5. Touch the left < or right > arrows next to the day of the week to go to the next or previous day and continue programming.
To COPY one day's programming to the next day, touch COPY> on the bottom right of the screen. The information for the current day will be copied to the next day and will appear on the screen.
6. Press HOME to return to the Home screen.

A/B program - The CT80 can hold 2 complete weekly programs in memory. Prog A is the default. The interview program is stored in prog A. To switch to the B program touch the A/B icon.

COMFORT

The Comfort Settings on the CT80 allow you to maintain consistent comfort with the highest levels of temperature control precision, accuracy and energy efficiency.

HVAC CYCLING: This feature allows you to set the desired variance in temperature between the CT80 setting and the room temperature required before the heating or cooling system will turn on—from 0.5° to 2.0° F (.25° to 1° C). For example, if HVAC CYCLING is set to 2.0° F and the CT80 is set to 70°F, the heat cycle will not start until the room temperature drops to 68°. Similarly, the cooling system will not kick-in until the room temperature increases to 72°F. The HVAC shuts off at the target.

To set/adjust HVAC CYCLING:

1. Press Menu and then touch “COMFORT.”
2. Touch the temp offset setting.
3. Use the +/- buttons to raise or lower the variance setting—from 0.5° to 2.0° F.
4. Press HOME to return to the Home screen.

2ND STAGE ON AT : This feature allows you to adjust the settings that control second stage heating and cooling depending upon the climate you live in. This can be modified for maximum efficiency or comfort. It is displayed if you have configured a multistage system in HVAC SET-UP.

To set/adjust 2ND STAGE ON AT:

1. Press Menu and then touch COMFORT
2. Touch and highlight the user setting (next to 2ND STAGE ON AT).
3. Use the +/- buttons to raise or lower the setting—from 2.0° to 4.5°F (1° to 2.5° C).
4. Press HOME to return to the Home screen.



Chirp set - Touch this to turn the audible chirp sound on or off.



F/C Set - Touch this to switch the temperature display scale from °F to °C .

HUMIDITY

The CT80 has a humidistat to control an external humidifier for humidifying by the H terminal.

HUMIDIFR - To set a minimum humidity level (with a humidifier installed in the HVAC) from the HOME screen:

1. Press MENU, then touch the HUMIDITY
2. Toggle HUMIDIFR from <OFF> to <W/HEAT>.
3. Touch MIN --% and use the +/- buttons to set the desired minimum humidity level.
4. The CT80 can be toggled <ALWAYS> run the humidifier when the humidistat calls for humidity (fan also runs) or can be set to run only when the humidistat is calling for humidity and the heat is also running <W/ HEAT>.

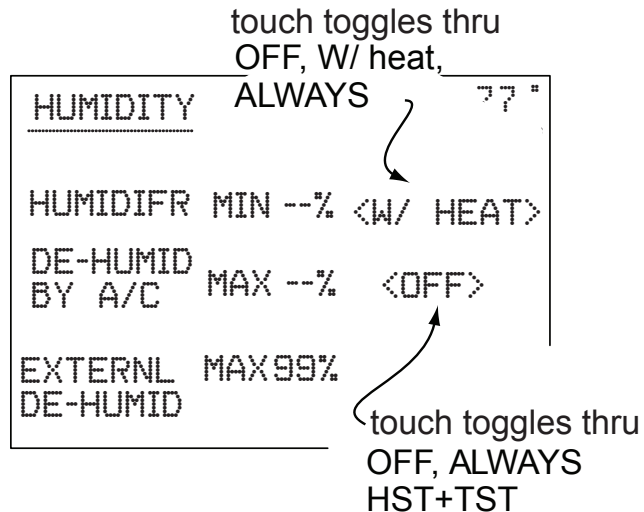

DE-HUMID BY A/C - The CT80's humidistat can also control the Air Conditioner for de-humidifying. To set a maximum humidity level (using the air conditioner):

1. Press MENU, then touch the HUMIDITY, then view DE-HUMID by A/C.
2. Touch MAX --% and use the +/- buttons to set the desired maximum humidity level. (You cannot change MAX humid % until you set it to ALWAYS or HST+TST)
3. The CT80 can be toggled to <ALWAYS> run the air conditioner when the humidistat calls to de-humidify or can be set to run the air conditioner only when the humidistat calls to de-humidify AND the thermostat is also calling for COOL <HTS+TST> (HST=humidistat, TST=thermostat).

EXTERNAL DE-HUMID - The CT80's humidistat can also control an external de-humidifier, if you have a dehumidifier unit installed in your HVAC system. Connect it to the DH terminal.

To set a maximum humidity level:

1. Press MENU, then touch the HUMIDITY.
2. Touch MAX --% and use the +/- buttons to set the desired maximum humidity level.
3. Press HOME to return to the HOME screen.

CONSUMABLES

Consumables are parts of your HVAC system that get used up; like filters and UV bulbs. The CT80 keeps track of system run times and can be programmed to remind you when consumables, such as air filters, humidifier pads and UV bulbs, should be checked and/or changed. (HUM PAD = Run time of humidifier, AIR FILTER = Run time of HEAT+COOL, UV BULB = Real time)

To set/adjust CHECK CONSUMABLES ALERTS:

1. Press Menu and touch CONSUMABLES, and select a CHECK ALERT to set.
2. Touch the number of weeks in the CHECK ALERT column for that item, and use the +/- buttons to raise or lower the setting.
 - Alerts may be scheduled from 0 to 99 weeks.
3. Repeat for each item included in your system.
 - If your system does not include a listed item, leave the CHECK ALERT at 00wks.
4. Press HOME to return to the Home screen.

When the Run Time for a given item reaches the limit you have set, the CT80 will show you a reminder in the message area of the Home screen.

```
CONSUMABLES 12:30p WED 75°
CHECK RUN
ALERT TIME
HUM PAD -----00wks 00wks
AIR FILTER---00wks 00wks
UV BULB-----00wks 00wks
```

HVACSET-UP

HVAC SET-UP allows you to configure the CT80 to control your HVAC system. The CT80 will control most residential systems. Take care to correctly set-up the CT80. Incorrect set-up can result in damage to your HVAC system.

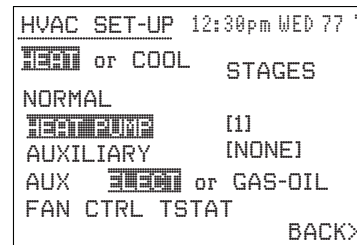

⚠ IMPORTANT: Make sure the CT80 is powered up and is in the OFF mode before set-up. (To turn your thermostat OFF, press  the Power button and select OFF.) Heating and cooling systems must be configured separately.

SET-UP for NORMAL systems (not a heat pump):

1. Press the purple **MENU** button on the control bar and then touch **HVAC SET-UP**.
2. Touch to highlight **HEAT** in the upper left corner of the display.
3. Touch to highlight **NORMAL**.
4. Select the appropriate number of stages for your heating system (from 1 to 3) by touching the number of STAGES to highlight, and using the +/- buttons to increase or decrease.
5. Touch the appropriate **FAN CONTROL** setting. Select **HVAC** if your heating system controls the fan (appropriate for most gas, oil, propane and similar furnaces). Select **TSTAT** if you want the thermostat to control the fan (for most electric heating systems).
6. Go on to configure **COOL** or press **HOME** to return to the Home screen.

SET-UP for NORMAL A/C cooling systems:

1. Press **MENU** and then touch **HVAC SET-UP**.
2. Touch and highlight **COOL** in the upper left corner of the display.

3. Select the number of stages of compression for your cooling system (1 or 2) by touching the number of **STAGES** and using +/- buttons to change.

NOTE: If your system does not have A/C select NONE as your number of stages and you won't be bothered with on-screen cooling messages

4. Touch to select the appropriate **FAN CONTROL** setting **HVAC** or **TSTAT**.

NOTE: Most cooling systems require that the thermostat **TSTAT** control the fan.

5. Press **HOME** to return to the Home screen.

SET-UP for HEAT PUMP systems (up to 3 Stages):

1. Press **MENU** and then touch **HVAC SET-UP**.

2. Touch **HEAT** in the upper left corner of the display.

3. Touch **HEAT PUMP**.

4. Select the number of stages of compression for your heat pump system (1 or 2) by touching the number of STAGES, and using the +/- buttons to increase or decrease.

NOTE: Most heat pump systems have one stage of compression.

5. If you have AUXILIARY heat, touch the number of AUX stages (default is [NONE]) use the +/- buttons to select the number of AUX stages (1-2 stages) in your system.

6. (If you have AUX) Select the type of auxiliary heat that you have - Electric or Gas-Oil.

NOTE: Most heat pump systems have electric heat strips for auxiliary heat.

7. Fan Control is by the CT80 (tstat) for heat pumps.

8. Press HOME button to return to the Home screen. NOTE: For heat pump system your cooling is already configured, the heat pump unit provides both heating and cooling.

NETWORK

Refer to your NETWORK system manual.

INFORMATION

Displays info and interactive screens from a network source. Refer to your NETWORK system manual.



LOCK The CT80 has 2 lock features. These control the users ability to change the temperature and other settings of the CT80.

To lock and/or control the ability to change the CT80:

1. Press MENU and then touch  LOCK icon in the lower right of the screen.
2. Select the desired LOCK feature by touching the function:
PARTIAL: Limits the user to temporary override the CT80 target temp. The override is limited to $\pm 9^{\circ}\text{F}$ ($\pm 5^{\circ}\text{C}$). To change this range touch "RANGE +/-" and using the +/- buttons to adjust up and down.
FULL: No changes can be made.

3. Press HOME to return to the Home screen.

Once LOCKED the CT80 will respond to a limited set of manual commands.

To UNLOCK :

1. Press MENU, touch and hold the LOCK icon for 10 seconds.
2. Touch LOCK OFF
3. Press HOME to return to the Home screen.

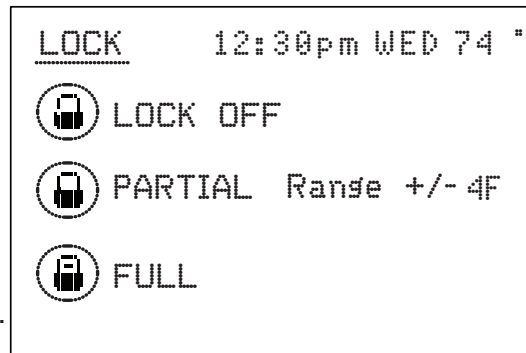

CALIBRATE

Your thermostat was accurately calibrated at the factory to $\pm 1^\circ$ F of actual ambient temperature. You do have the option, however, to change the display temperature to match that of a previous thermostat, or to match another thermostat already in your home, from $\pm 1 - 9^\circ$ F ($\pm 1-5^\circ$ C).

To change your Thermostat Calibration:

1. Press **MENU** and then touch **CALIBRATE**
2. Use the + / - buttons to adjust the displayed temperature up or down, as desired.
3. The DELTA FACTOR that appears on the screen will also automatically increase or decrease for each 1° F (or 0.5° C) adjustment. The large display will show the modified temperature reading that will be displayed on the HOME screen and used as the new room temp.
4. Press **HOME** to return to the Home screen .

LCD Screen CONTRAST can be adjusted.

To change LCD Screen CONTRAST

From the CALIBRATE screen:

1. Select **CONTRAST** and adjust by touching the on-screen < and > controls for best viewing.
2. Press **HOME** to return to the Home screen.

Calibrate controls

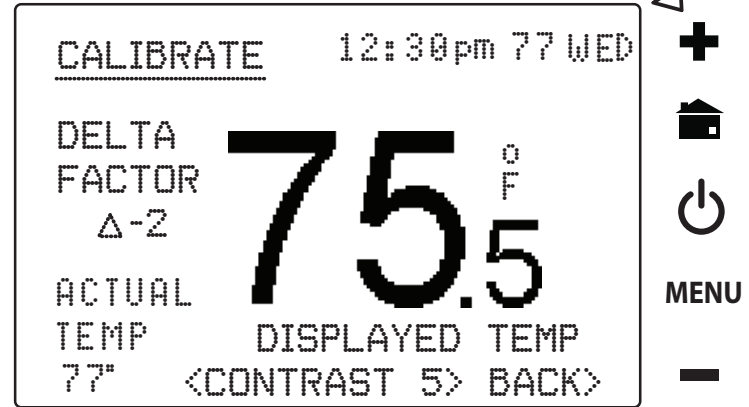

Save Energy Button

The “Save Energy” feature on the CT80 provides a simple, easy-to-use way to help you manage your energy use. SAVE ENERGY automatically adjusts your target temperature up [in COOL] or down [in HEAT] by a saved value degrees (four degrees is the default).

- To use Save Energy, simply press Save Energy button in the upper left corner of the unit
- The screen will now read “Save Energy $\Delta 4^\circ$ and the Target Temperature will adjust by that offset. Use the +/- buttons to change the offset. Range 2° - 9° F [1° - 5° C]
- To return to normal operation, press the “Save Energy” button again, and the TARGET TEMP will return to the programmed temperature.

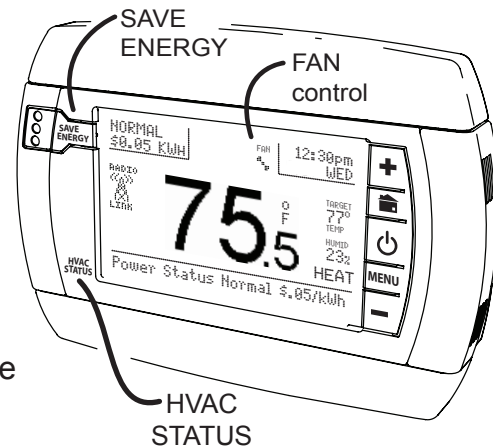

FAN control

To view the fan status, touch the FAN icon located at the top center of the **HOME** screen.

AUTO: The fan control is normally set to AUTO mode, meaning that the fan operates automatically, only when the HVAC system is also running.

CIRC: The CIRC function allows your fan to automatically circulate air for up to nine minutes per hour for better indoor air quality and efficiency.

FRESH: If your HVAC system has a fresh air baffle, touch FRESH to use fresh air with HVAC. This works with AUTO or ON. The fresh air baffle must be connected to the EX terminal on the CT80.

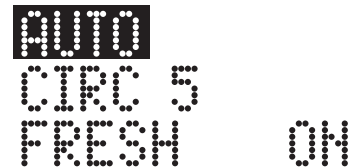

ON: To manually turn **ON** the fan, touch the FAN icon and then touch **ON**.

The FAN icon will begin turning and the fan will run continuously until switched to **AUTO**. Fan **ON** function is available in OFF mode to allow simple ventilating.



POWER BUTTON and MODE selection

The power button brings up your mode selection options: **COOL HEAT AUTO OFF**

COOL - This will operate the cooling portion of your HVAC system until it is turned off.

HEAT - This will operate the heating portion of your HVAC system until it is turned off.

AUTO - The CT80 TRUE AUTO mode switches automatically between heat and cool throughout the year. Unlike other manufacturers, the CT80 TRUE AUTO has no temperature or time limitations (Patent pending), just program your desired HEAT and COOL temps and select the AUTO mode. The CT80 will switch from HEAT to COOL as needed.

OFF- This takes your HVAC system “off-line” and it will not control HVAC functions. In this mode your house may experience extreme heat or cold.

The HVAC STATUS indicator shows what HVAC function is active. It glows orange when the **HVAC STATUS** HEAT function is active, blue when the COOL function is active, and green when the fan is active. These indicators can combine, where orange-green indicates HEAT-FAN and BLUE-GREEN indicates COOL-FAN.

RESET button - The RESET button re-boots the CT80 processor. It does not effect the user programs that have been stored in permanent memory.

NETWORK

The NETWORK button allows you to identify the network you are connected with and further manage your settings. You can connect your CT80 to an AMI network for In Home Display of electric meter data or connect to a Home Automation network for HA functionality with remote access to your HVAC system and home conditions.

To Insert a RTM-1 radio module:

1. Power off the CT80
2. Insert the the radio module in either slot on the back of the CT80.
3. Power up CT80.

NOTE: DO NOT HOT SWAP RTM-1 modules this can damage the thermostat or radio modules.

To MATE to a network:

1. Select **MENU**, then **NETWORK**.
2. Make sure the network is ON.
3. Select the Radio Icon for the radio you want to mate with the network.
4. Touch Mate. Initiate the mate procedure on the network device side. Wait for radios to sync.
5. The CT80 will display the netname (network name) it is connected to under “network”.

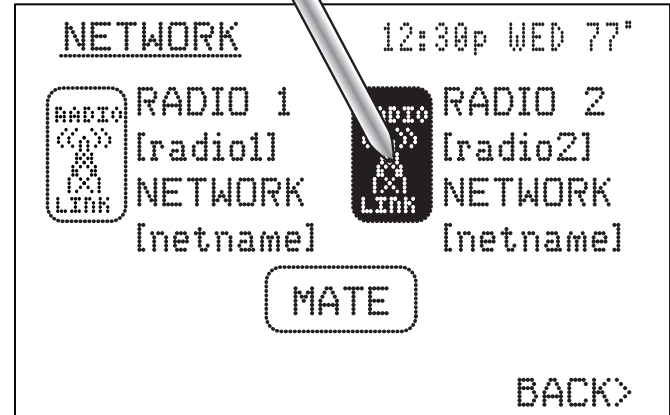
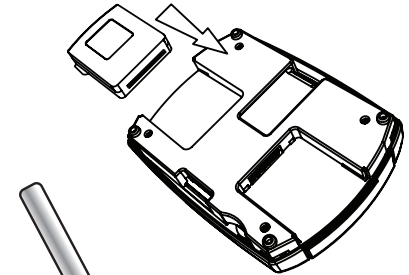

INFORMATION

This MENU function displays information and interactive screens from a network source. The network can display interactive information screens, poll users, and display electrical rate and usage information from your utility or enabled power meter.

Home automation systems can also utilize the INFORMATION function for interactive and informative messages. They can display text and alpha numeric information on energy use, HVAC status, and other network connectivity.

These messages are generated by another network source and displayed on the CT80. Consult your AMI or Home Automation network documentation for further information.

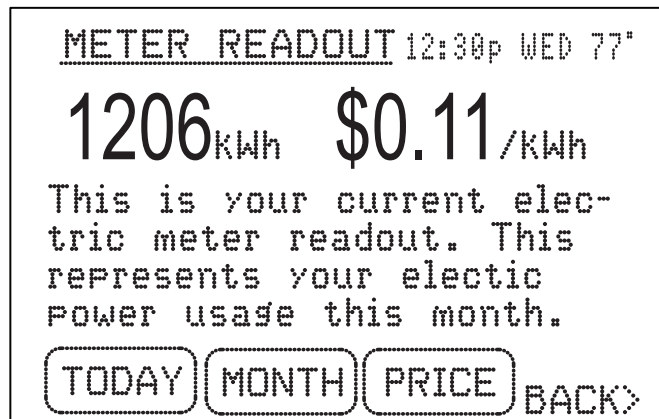

sample INFORMATION screen