

Assembly Instructions

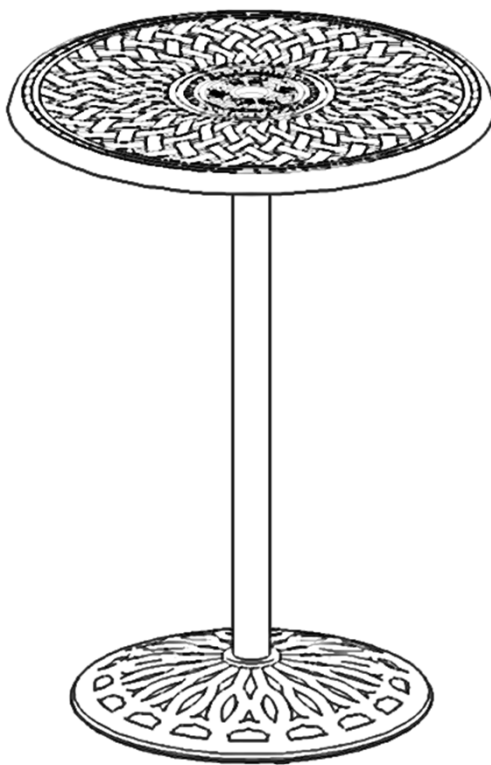

Caution : You must read this before you proceed.

Bar Table





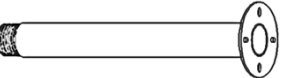
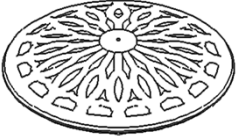





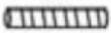



**CAUTION : This table is NOT a TOY.
Keep your child / children at bay in the process of assembly.**

Parts List

No.	Picture	Description	Qty
A		Pedestal - Lower	1
B		Pedestal - Upper	1
C		Table Base	1
D		'X' Plate	1
E		Table Top	1

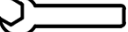
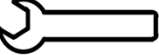
Hardware

No.	Picture	Description	Qty
①		Studs(M8*45mm)	5
		Washers (8mm)	5
		Springs Washers (8mm)	5
		Nuts (8mm)	5
②		Bolts (M8*30mm)	5
		Washers (8mm)	4
		Spring Washers (8mm)	4
		Nuts (8mm)	4
③		Washers (12mm)	1
		Spring Washers (12mm)	1
		Nuts (12mm)	1
④		Spanner (8mm)	2
⑤		Spanner (12mm)	1
⑥		Screwdriver	1

Assembly Preparation

Before Beginning Assembly:

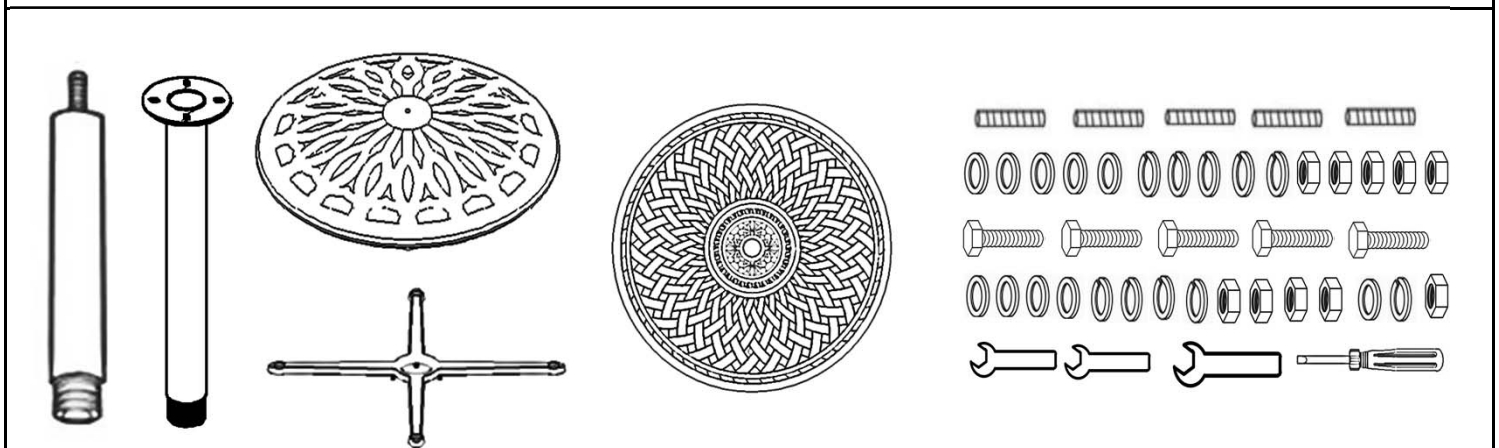

- Read instructions, cover to cover-



- Have 2 adults on hand for assembly-



- Do not assemble on flooring or carpet-



- Assemble on a clean non-marring surface (packing foam)-



- Save all packaging until finished-

Assembly Steps

Overview

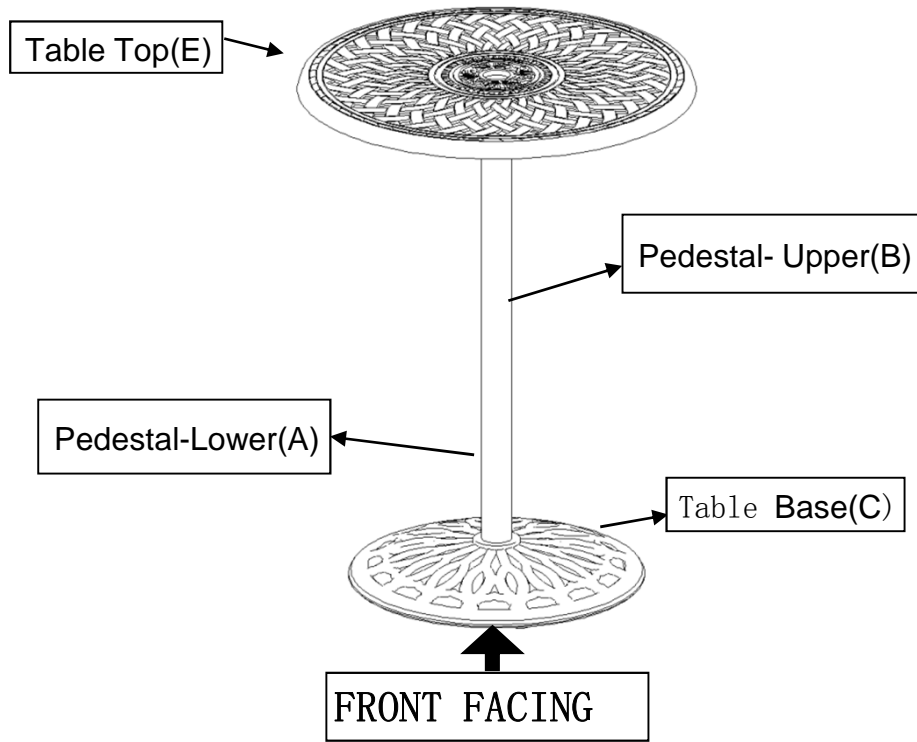

This Bar Table has multiple parts and may require up to 30 minutes to assemble. To give you an overview of the Bar Table parts, the above picture is to help you put the various parts into perspective. Please read through the instructions here below to familiarise yourself with the parts and steps before assembly.

Step 1

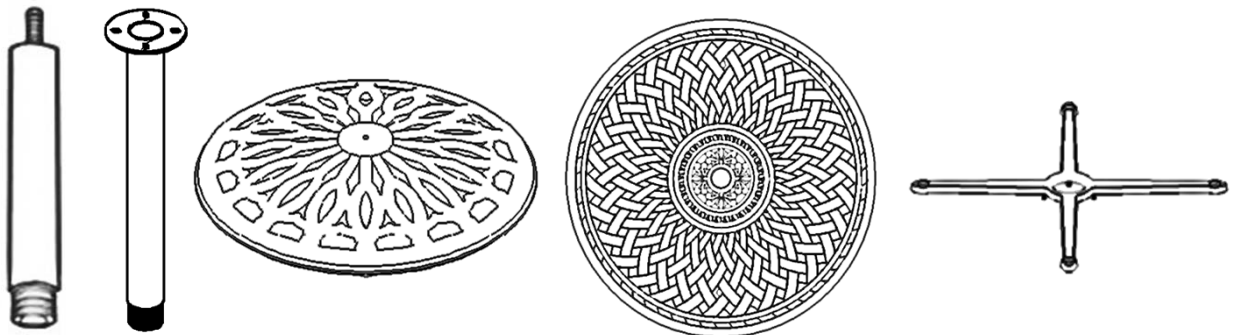

Unpack and place all parts on a clean soft surface.

Step 2

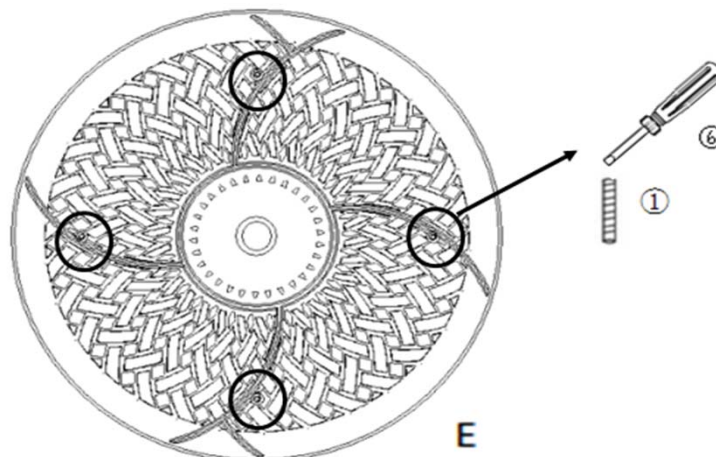

To the underside of the Table Top, there are 4 (four) assembly points.
Insert Studs(①) into these 4 (four) positions with Screwdriver(⑥).
Fully tighten the studs.

Step 3

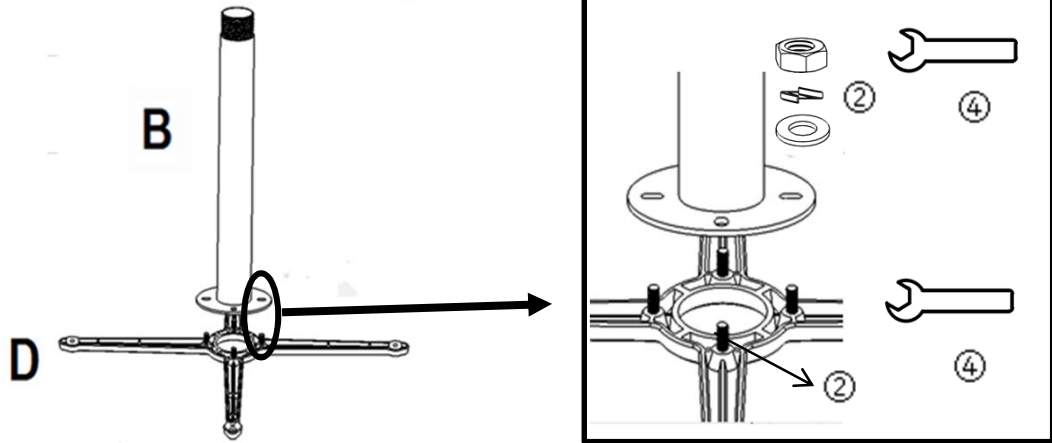

Affix 'X' Plate (D) to the top of Upper Pedestal (B).
Align the mounting position on the 'X' Plate(D) with the mounting position on the top of Pedestal (B).
Then, insert the Bolt(②) from the 'X' Plate to the Pedestal.
Then, fix the bolt with Spring Washer & Washer & Nut (②) using Spanner(④).
Fully tighten all the nuts.

Step 4

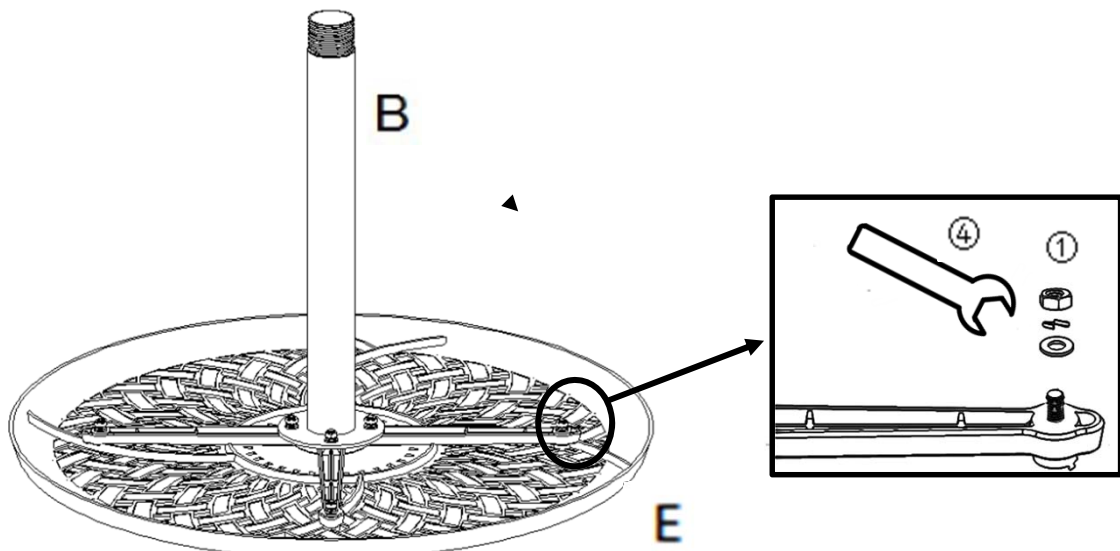

Attach the 'X' Plate, from Step 3, to the Table Top(E).
Insert the holes on the 'X' plate to the pre-attached Bolts on the Table Top(E).
Using the Spanner(④), **turn in and tighten** : Flat Washers, Spring Washers and Nuts(①).
Fully, tighten all Nuts.

Step 5

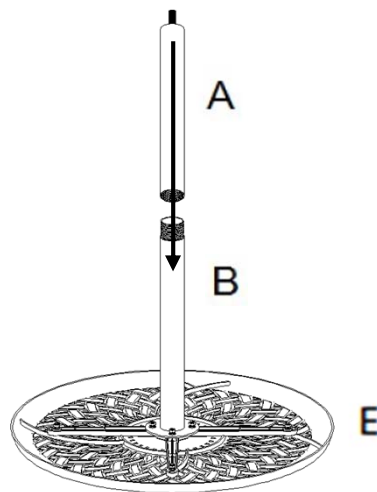

Attach the Pedestal - Lower (A) to the Pedestal(B) by turning the Pedestal (A) clockwise.

Step 6

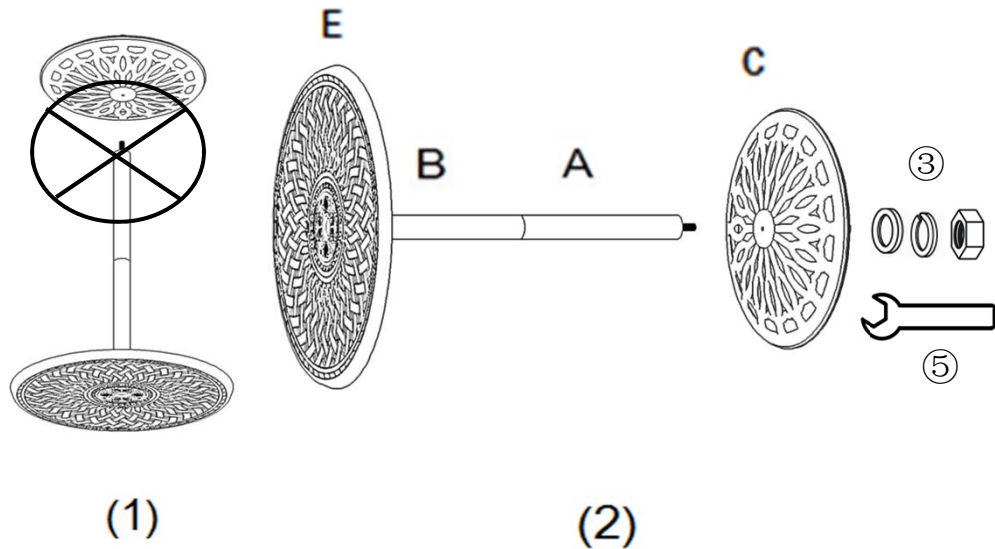

WARNING : DO NOT LIFT UP the Table base to assemble as shown in picture 1

Have your partner hold the Table Top on its side as shown in picture 2.

Insert the screw on the Pedestal - Lower (A) to the hole on the Table Base(C).

Using the Spanner(5), turn in and tighten : Flat Washers, Spring Washers and Nuts(3).

Fully tighten the Nut.

Step 7

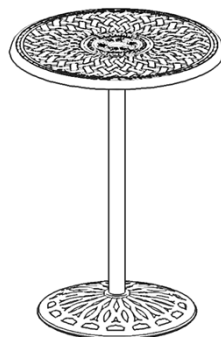

Ensure all Bolts and Screws are FULLY TIGHTEN UP.









Turn the Table right side up.

Adjust the pre-attached leg leveller at the end of Table Base until the Table is level with the ground.

Your Bar Table is ready for use.

Caution: This Bar Table can only be used on a flat, level surface.

Care & Maintenance

-  ● Do not put hot items directly on furniture surface
 -  ● Do not clean furniture with harsh cleansers or polish.
 -  ● To obtain the longest lifespan of your outdoor products, minimizing exposure to direct sunlight is recommended.
 -  ● Children should not climb or jump on the furniture.
 -  ● Do not write on furniture without a padded barrier to protect the surface.
 -  ● To obtain the longest lifespan of your outdoor products, avoid extended and lengthy exposure to rain, snow, and direct sunshine. Whenever possible cover the product and /or place under patio or awnings.
 -  ● Not for commercial use. For residential use only .
 -  ● Stains may be removed with mild soap solution and damp cloth.
-
-  ● Dust and pick-up spills using a clean, non-colored, lint-free cloth .

What is Proposition 65?

Proposition 65 is a California law that requires warning labels on products that may contain one of more than 800-plus chemicals or ingredients that the California Office of Environmental Health Hazard Assessment (OEHHA) has deemed to cause cancer or other reproductive toxicity. Chemicals and elements on this list include wood dust, brass, and other everyday substances, which can be found in very common household items, such as: lamps, tableware, jewelry, crystal glasses, electric cords, beauty products, automobiles, and furniture.

Why Did I Find a Proposition 65 Warning on My Home Goods Product?

We include Proposition 65 warnings on all of our products because there is always a chance that one of the 800-plus common chemicals and ingredients listed under this law could potentially be on our furniture or packing materials. We risk large fines under this law, if we don't include this warning.

Should I worry?

We realize you may be worried finding this warning on our products, but we want to reassure you that the hazardous exposure limits for any of these chemicals have never been found on furniture products that we've shipped to our customers. Additionally, this warning label is very common and can be found on almost every piece of furniture sold in the state of California.

Just How Common Are Proposition 65 Warnings?

Proposition 65 warnings have become so common in California that it is hard to take a trip to a local bank, grocery store, or restaurant without finding at least one warning. In fact, even the Disney Land Resort has a Proposition 65 warning:

