

Item # GEN7000
7000 Surge Watts / 6000 Running Watts
ELECTRIC START PORTABLE GENERATOR
INSTRUCTION MANUAL

READ ALL INSTRUCTIONS AND WARNINGS BEFORE USING THIS PRODUCT.

This manual provides important information on proper operation & maintenance. Every effort has been made to ensure the accuracy of this manual. These instructions are not meant to cover every possible condition and situation that may occur. We reserve the right to change this product at any time without prior notice.

**IF THERE IS ANY QUESTION ABOUT A CONDITION BEING SAFE OR UNSAFE,
DO NOT OPERATE THIS PRODUCT!**

Visit our website for Frequently Asked Questions <http://sportsmanseriesbrand.com>

**DO NOT RETURN THIS GENERATOR TO THE
RETAILER!**

If you experience a problem, have questions or need parts for this product, call Customer Service at **1-866-460-9436, Monday-Friday, 8 AM - 4 PM Central Time**. A copy of the sales receipt is required.

FOR CONSUMER USE ONLY – NOT FOR PROFESSIONAL USE.

KEEP THIS MANUAL, SALES RECEIPT & APPLICABLE WARRANTY FOR FUTURE REFERENCE.

 DANGER

SEEK THE ADVICE OF A LICENSED ELECTRICIAN FOR 120V / 240V WIRING

Model GEN7000 7000 Surge Watts / 6000 Running Watts Electric Start Portable Generator

This unit is a Gasoline driven generator

FEATURES:

- 7000 Surge Output
- 6000 Running Watts
- 120/240 Volt Operation
- 13 HP Engine, 4 Stroke OHV
- Air Cooled
- 7 Gal. Fuel Tank w/Gauge
- AVR Automatic Voltage Regulation
- Electric and Recoil Start
- Low Oil Shut Off
- UL Listed Electrical Components
- Full Power Panel
- Engine Shut Off Switch
- Circuit Breaker & Power Outlets
- 1-12V DC Outlet
- 4-120V A/C GFCI Outlets
- 1-120/240V Outlet
- Complies with EPA emissions
- Run time = 12 hours @ 50% load
- Battery Not Included



(A 12 Volt motorcycle battery no larger than 7 1/4" length, 6 1/2" height, and 3" width is required for electric start of this generator.

(The ideal battery required is 7 1/8" L x 6" H x 3"W, 130 Min CCA Cold Cranking Amps)

Comparable brands/models are: Yuasa: YB9A-A, YB9-B or YB9L-B, Delco: CB9A-A, NAPA: 740-1872, 740-1858, 740-1837

Sears: 44043, 44356, 44045, Generic brand SLA-12V22

• High Altitude Use: This generator is not recommended for high altitude use above 3,000 feet.

• If you are using a generator above sea level, the generator may not function properly because of air flow getting through the mixer.

2 YEAR LIMITED EMISSION-RELATED WARRANTY

THIS ENGINE MEETS U.S. EPA EMISSION STANDARDS UNDER 40 CFR 1054.625. The emission-related limited warranty is valid for two (2) years. Keep the purchase receipt and mail in the product registration card for proof of purchase. Buffalo Corp limits emission-related warranty repairs to authorized service centers for owners located within 100 miles of an authorized service center. For owners located more than 100 miles from an authorized service center, Buffalo Corp will, in its sole discretion, either pay for shipping costs to and from an authorized service center, provide for a service technician to come to the owner to make the warranty repair, or pay for the repair to be made at a local non-authorized service center. The provisions of this paragraph apply only for the contiguous states, excluding the states with high-altitude areas identified in 40 CFR part 1068, Appendix III.

To exercise this warranty, DO NOT RETURN TO RETAILER. Instead, call Customer Service toll free at 1-866-460-9436 (email address info@buffalotools.com) and you will be instructed on where to take the engine for warranty service. Take the generator and proof of purchase (your receipt) to the repair facility recommended by the Customer Service Representative. The warranty does not extend to generators damaged or affected by fuel contamination, accidents, neglect, misuse, unauthorized alterations, use in an application for which the product was not designed and any other modifications or abuse.

1 YEAR LIMITED WARRANTY (30 Day Limited Warranty for Commercial and Rental Purpose)

Generators are warranted to be free from defects in materials and workmanship for a period of 1 YEAR from date of original purchase. Buffalo Corp. is not liable for any indirect, incidental or consequential damages from the sale or use of this product. Any implied warranties are limited to 1 YEAR as stated, or as otherwise stated, in this written limited warranty. Some states do not allow the exclusion or limitation of incidental or consequential damages. Some states do not allow limitation on the length of an implied warranty. Buffalo Corp will repair or replace, at its discretion, any part that is proven to be defective in materials or workmanship under normal use during the 1 YEAR warranty period. Warranty repairs or replacements will be made without charge for parts or labor. Parts replaced during warranty repairs will be considered as part of the original product and will have the same warranty period as the original product. This warranty gives you specific legal rights, and you may have other rights that vary state to state.

TABLE OF CONTENTS

| | |
|-------------------------------------------------|----|
| RECOGNIZE SAFETY SYMBOLS, WORDS AND LABELS..... | 4 |
| PACKAGE CONTENTS | |
| PACKAGE CONTENTS | 9 |
| COMPONENTS | 10 |
| PREPARING THE GENERATOR FOR USE | 11 |
| Using This Generator For The First Time..... | 11 |
| Step 1 – Add Oil | 11 |
| Step 2 – Add Gasoline | 12 |
| Step 3 – Ground The Generator..... | 13 |
| Subsequent Use Of This Generator..... | 13 |
| Step 1 – Verify Oil Level..... | 13 |
| Step 2 – Verify Gas Level..... | 14 |
| Step 3 – Ground The Generator..... | 14 |
| STARTING THE GENERATOR | 14 |
| USING THE GENERATOR..... | 16 |
| AC Usage..... | 16 |
| DC Usage..... | 18 |
| STOPPING THE GENERATOR..... | 19 |
| MAINTENANCE/CARE | 20 |
| Recommended Maintenance Schedule | 20 |
| Cleaning The Generator..... | 20 |
| Checking The Oil Level | 20 |
| Changing/Adding Oil | 21 |
| Air Filter Maintenance | 21 |
| Spark Plug Maintenance | 23 |
| Emptying The Fuel Tank | 23 |
| STORAGE/TRANSPORT PROCEDURES | 24 |
| TROUBLESHOOTING | 25 |
| SPECIFICATIONS | 26 |
| PARTS DIAGRAM | 27 |
| PARTS LIST..... | 28 |
| PORTABILITY KIT INSTALLATION..... | 31 |

RECOGNIZE SAFETY SYMBOLS, WORDS AND LABELS

What You Need to Know About Safety Instructions

Warning and Important Safety Instructions appearing in this manual are not meant to cover all possible conditions and situations that may occur. Common sense, caution and care must be exercised when operating or cleaning tools and equipment.

Always contact your dealer, distributor, service agent or manufacturer about problems or conditions you do not understand.



This is the safety alert symbol. It is used to alert you to potential personal injury hazards. Obey all safety messages that follow this symbol to avoid possible injury or death.



DANGER indicates an imminently hazardous situation which, if not avoided, will result in death or serious injury.



WARNING indicates a potentially hazardous situation which, if not avoided, could result in death or serious injury.



CAUTION indicates a potentially hazardous situation which, if not avoided, may result in minor or moderate injury.



CAUTION used without the safety alert symbol indicates a potentially hazardous situation which, if not avoided, may result in property damage.



SEEK THE ADVICE OF A LICENSED ELECTRICIAN FOR 120V / 240V WIRING

Enlarged View Of 120/240 Volt Outlet

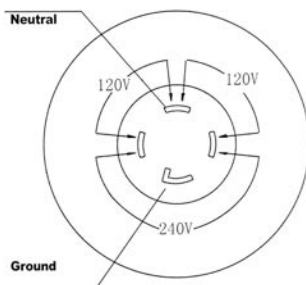

Floating Neutral:

This generator has a "floating neutral" 240 plug, which means that the neutral circuit is not connected to the frame or to earth ground. This also means that both legs on the receptacle are hot legs. As a result, there is no specific hot leg and neutral leg wiring arrangement for the generator winding connection to the receptacle. The floating neutral configuration is common for applications such as connection to a recreational vehicle and connection to home power where the transfer switch does not switch out the neutral to ground connection. You must connect the neutral to your existing panel neutral.

Notice Regarding Emissions:

Engines certified to comply with California and U.S. EPA emission regulations for SORE (Small Off Road Equipment) are certified to operate on regular unleaded gasoline and may include the following emission control systems: Three-Way Catalyst (TWC) (if equipped), and Engine Modifications (EM).

Legal Requirements:

Federal and/or State Occupational Safety and Health Administration (OSHA) regulations, local codes, and/or ordinances may apply to the intended use of this generator. Consult a qualified electrician, electrical inspector, and/or the local agency having jurisdiction. Some areas require generators to be registered with local utility companies. Additional regulations may apply if this generator will be used at a construction site.

High Altitude Use:

This generator is not recommended for high altitude use above 3,000 feet.

IMPORTANT SAFETY INSTRUCTIONS

STOP!

Before using this generator and if you have any questions regarding the hazard and safety notices listed in this manual and/or on this generator, call 1-866-460-9436, Monday - Friday, 8 AM - 4 PM Central Time.

DANGER

Carbon Monoxide Gas: When in operation, the exhaust from this generator contains poisonous carbon monoxide gas. Carbon monoxide gas is both odorless and colorless AND may be present even if you do not see or smell gas. Breathing this poison gas can lead to headaches, dizziness, drowsiness, loss of consciousness and eventually death.

- Use this generator ONLY outdoors in non-confined areas.
- Keep at least several feet of clearance on all sides to allow proper ventilation for this generator.

WARNING

Flammable Gasoline: This generator may emit highly flammable and explosive gasoline vapors, which can cause severe burns or even death. A nearby open flame can lead to an explosion even if not directly in contact with gasoline.

- Do not operate this generator near open flame.
 - Do not smoke near this generator.
 - Always operate this generator on a firm, level surface.
- Gasoline is highly flammable and explosive. Handling fuel can result in serious injury or burns.**
- Always shut down this generator before refueling. Refuel in a well-ventilated area. Keep heat, sparks and flame away while refueling and away from the location where gasoline is stored. Never refuel indoors where gasoline fumes may reach flames and/or sparks.
 - Allow this generator to cool for at least 2 minutes before removing the fuel tank cap. Loosen the cap slowly to relieve pressure in the fuel tank. Avoid spilling fuel.
 - Do not fill the fuel tank above the upper limit line. Gasoline may expand during operation. Do not fill to the top of the tank.
 - Always check for spilled gasoline and immediately wipe it up before starting this generator.
 - Empty the fuel tank before storing or transporting this generator.
 - Always handle fuel outdoors.
 - Before transporting, turn the fuel valve to the "off" position and disconnect the spark plug.

⚠ DANGER

Powerful Voltage: This generator produces powerful voltage, which can result in electrocution.

- ALWAYS ground this generator before using it. (See "Ground the Generator" section in this manual).
- Only electrical devices should be plugged into this generator, either directly or with an extension cord. NEVER connect a building electrical system to this generator without a qualified electrician. **Doing so voids your warranty.** Such connections must isolate generator power from utility power and comply with local electrical laws and codes. Failure to comply can create a back feed into utility lines creating an electrocution hazard, which may result in serious injury or death to utility workers. Such a back feed may cause this generator to explode, burn and create fires when utility power is restored.
- Use a ground fault circuit interrupter (GFCI) in highly conductive areas such as metal decking or steel work. GFCIs are available in-line with some extension cords.
- Do not use this generator in wet conditions (rain, snow, active sprinkler system, wet hands, etc.). Always keep this generator dry and operate it with dry hands.
- Do not touch bare wires or outlets (receptacles).
- Do not allow children or non-qualified persons to operate this generator.

⚠ DANGER

High Temperatures: This generator produces heat when in operation. Temperatures near the exhaust can exceed 150 Degrees Fahrenheit (65 Degrees Celsius).

- Do not touch hot surfaces. Observe all warning placards on this generator denoting hot surfaces.
- Allow this generator to cool for several minutes after use before touching the engine, muffler or other areas that are hot during operation and before storing indoors.
- Hot exhaust may ignite some materials. Keep flammable materials away from this generator.
- Keep at least several feet of clearance on all sides of this generator during operation. Do not enclose this generator in any structure.

⚠ CAUTION

Usage: Misuse of this generator can damage it or shorten its life.

- Use this generator only for its intended purpose.
- Operate this generator only on a dry, level surface.
- Allow this generator to run for several minutes before connecting any electrical devices.
- Promptly turn off any malfunctioning devices and disconnect them.
- Do not operate an excessive number of electrical devices in excess of the wattage capacity of this generator.
- Do not turn on electrical devices until *after* they are connected to this generator.
- Turn off all connected electrical devices before stopping this generator.

⚠ WARNING

Usage: Consult a physician(s) before using this generator if using a pacemaker. Electromagnetic fields in close proximity to a heart pacemaker could cause a pacemaker to malfunction or fail. Caution is necessary when near the engine's recoil starter.

⚠ CAUTION

Usage: Prolonged exposure to high noise levels can be hazardous to hearing. Always wear ANSI-approved hearing protection when operating or working around the generator when it is running.

CAUTION

Usage: This generator is not intended to power sensitive electronic equipment such as TVs, DVD players, stereos, desktop computers or laptop computers without the use of an appropriate line conditioner and/or surge protector (both not included). Sensitive electronic equipment should be operated on approved inverter type generators or pure sine wave generators. For additional information consult the devices operation manual or call customer service at 1-866-460-9436 Monday - Friday, 8 AM - 4 PM Central Time.

⚠ WARNING

Usage: Avoid the use of extension cords if possible. If you choose to use them, be sure they are sized adequately to handle the flow of electricity. An undersized cord can overheat, short out and cause a fire.

⚠ CAUTION

Usage: Do not use fuel stabilizers with this generator, doing so could cause damage to the generator, or decrease the fuel and operating efficiency of the generator. You may choose to add a fuel conditioner to oxygenate the fuel and to help it run more efficiently.

DANGER

EXHAUST CONTAINS POISONOUS CARBON MONOXIDE GAS THAT CAN BUILD UP TO DANGEROUS LEVELS IN CLOSED AREAS. BREATHING CARBON MONOXIDE CAN CAUSE UNCONSCIOUSNESS OR DEATH. Never run the generator in a closed or even partly closed area where people may be present.

WARNING

GASOLINE IS HIGHLY FLAMMABLE AND EXPLOSIVE. YOU COULD BE BURNED OR SERIOUSLY INJURED IF THE GASOLINE IS IGNITED. Before refueling, stop the engine and keep heat, sparks and flame away. Handle fuel only outdoors. Do not fill the fuel tank above the upper limit line. Wipe up spills immediately.

WARNING

IMPROPER CONNECTIONS TO A BUILDING CAN ALLOW ELECTRICAL CURRENT TO BACKFEED INTO UTILITY LINES, CREATING AN ELECTROCUTION HAZARD. Connections to a building must isolate generator power from utility power and comply with all applicable laws and electrical codes.

In addition to the previously described safety information, familiarize yourself with all safety and hazard placards on this generator.

⚠ DANGER POISONOUS GAS

Generator exhaust contains toxic carbon monoxide gas. Breathing exhaust can cause loss of consciousness and shortness of breath. NEVER operate generator in poorly ventilated areas.

⚠ WARNING

Risk of electric shock. Do not remove cover. No user serviceable parts inside. Refer servicing to qualified service personnel.

⚡ WARNING! RISK OF ELECTRIC SHOCK

This generator produces high voltage.
 Always ground properly before use.
 Do not connect to any building electrical system.
 Never use in rainy or wet conditions.
 Never touch bare wires or receptacles.
 Never allow children or non-qualified person to operate.



⚠ CAUTION! HOT EXHAUST

🚫 DO NOT TOUCH

⚠ 🚫

**CAUTION!
 HIGH TEMPERATURE
 DO NOT TOUCH**

⚠ DANGER

Using a generator indoors CAN KILL YOU IN MINUTES. Generator exhaust contains carbon monoxide. This is a poison you cannot see or smell.

| | | |
|------------------------------------------------------------------------|--|---------------------------------------------------------------|
| | | |
| NEVER use inside a home or garage. EVEN IF doors and windows are open. | | Only use OUTSIDE and far away from windows, doors, and vents. |

PACKAGE CONTENTS

The following items are supplied with this Generator. Verify that all items are included.

STOP!

If there are missing items, call 1-866-460-9436, Monday - Friday, 8 AM - 4 PM Central Time for customer service. **DO NOT RETURN THIS GENERATOR TO THE RETAILER.**

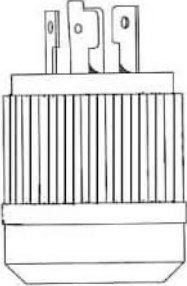
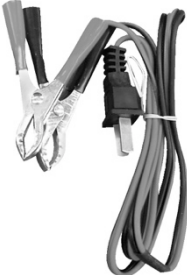
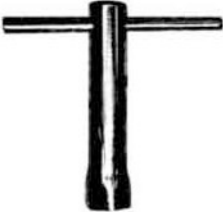
| Item List: | |
|-------------------------------------------------------------------------------------|---------------------------------------------------------------------------|
|  | NEMA L14-30 plug for connecting 240 Volt electrical devices |
|  | DC battery charging cables for charging 12 Volt automotive-type batteries |
|  | Spark plug wrench |

GENERATOR COMPONENTS

Observe the locations and functions of the various components and controls of this generator.

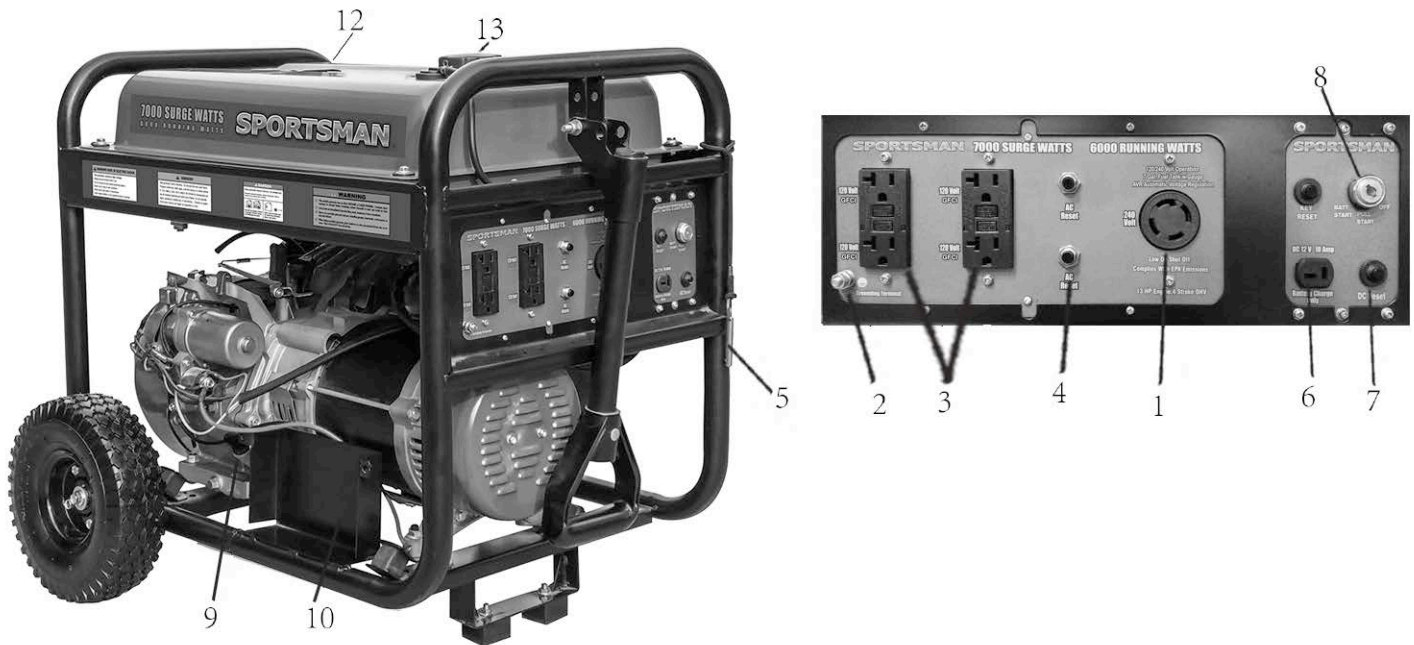

- (1) **120/240 Volt AC Outlet** - Used for connecting electrical devices that run on 120 and/or 240 Volt, 60 Hz, single phase, AC current.
- (2) **Ground Terminal** - Used for connecting grounding wires to properly ground this generator.
- (3) **120 Volt AC GFCI Outlet** - Used for connecting electrical devices that run on 120 Volt, 60 Hz, single phase, AC current.
- (4) **AC Reset**- Breaker that protects this generator from electrical AC overload and short circuit.
- (5) **Plug Lock**- Used for preventing the handle from falling down.
- (6) **12 Volt DC Outlet** - Only used for charging 12 Volt automotive-type batteries.
- (7) **DC Reset**- Breaker that protects this generator from electrical DC overload and short circuit.
- (8) **Key Start**
- (9) **Oil Filler Dipstick Cap** - Location for checking and filling the engine crankcase oil.

- (10) **Battery Case**
- (11) **Recoil Starter** - Pull-cord for starting the engine.
- (12) **Fuel Gauge** - Indicates the amount of gasoline remaining in the fuel tank.
- (13) **Fuel Tank Cap** - Access to the fuel tank for adding gasoline.
- (14) **Spark Plug** - Provides ignition to the engine.
- (15) **Fuel Filter Cup** - Traps dirt and water from the fuel prior to entering the engine.
- (16) **Air Filter** - A removable, cleanable, sponge-like element that limits the amount of dirt pulled into the engine.
- (17) **Choke Lever** - Adjusts the amount of air allowed into the engine.
- (18) **Muffler** - Reduces the engine noise level.
- (19) **Fuel Valve** - Allows gasoline to pass into the engine.

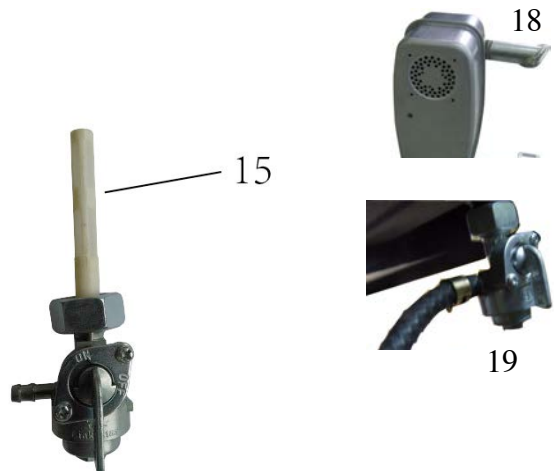
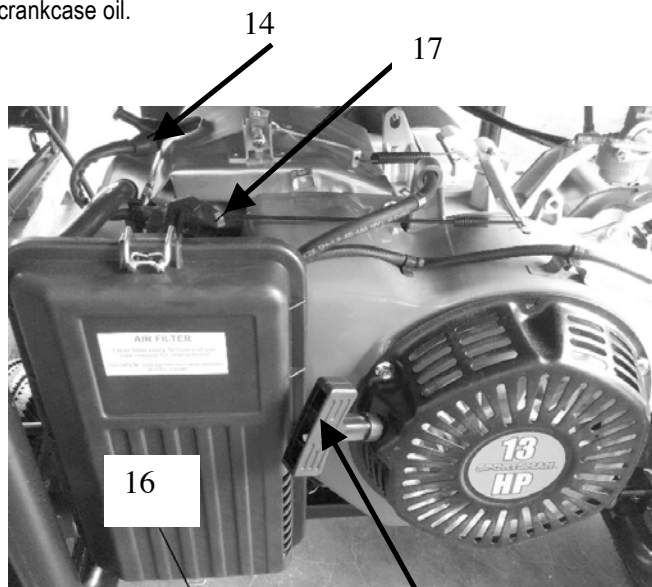

PREPARING THE GENERATOR FOR USE

Using this Generator for the First-Time

STOP!

CAUTION

The following section describes the required steps for preparing this generator for the first use. Failure to correctly perform these steps can damage this generator and/or shorten its life. If still unsure about how to perform any of these steps after reading this section, call 1-866-460-9436 Monday - Friday, 8 AM - 4 PM Central Time for customer service.

If this generator is being used for the first time, the following few steps are required to prepare it for operation:

Step 1 - Add Oil

This generator requires engine oil to function. Engine oil is a major factor affecting engine performance and service life. When new from the package, this generator contains no oil in the engine crankcase. The correct quantity of oil is equal to the oil capacity of the engine crankcase. Add the correct quantity of oil before operating this generator for the first time. When replenishing oil for subsequent use of this generator, always determine that this generator has the correct quantity of oil.

| | |
|-------------------------------|-------------------------------------|
| Oil Capacity (Qt/fluid oz./L) | 1.2 / 38 / 1.13 |
| Oil Type Recommended | High Detergent Motor Oil, SAE10W-30 |

To add oil:

1. Confirm that this generator is on a level surface.
2. Unscrew the oil filler/dipstick cap from the engine as illustrated in Figure 1.
3. Using a funnel, add high detergent motor oil to fill the engine crankcase to the correct quantity. SAE10W-30 oil is recommended for general, all-temperature use. **When the engine crankcase is full, the oil level should reach all the way up to the threads** as illustrated in Figure 2.
4. Replace the oil filler/dipstick cap.

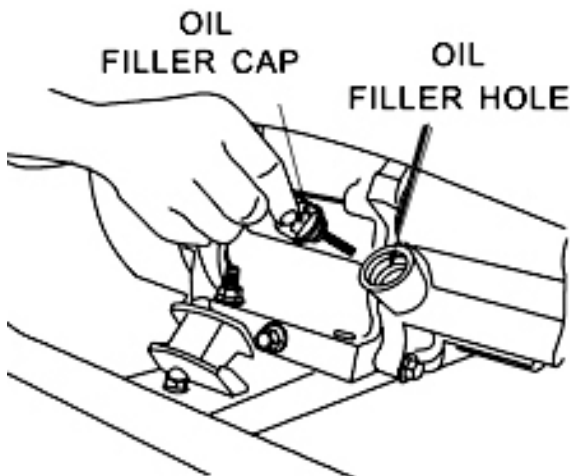

Figure 1 - Unscrew the Oil Cap



Figure 2 - Add Oil To TOP Of Threads

Step 2 - Add Gasoline

WARNING

Gasoline and gasoline fumes are highly flammable and explosive. Handling fuel can result in serious injury or burns.

- Do not fill the fuel tank near a heat, sparks or an open flame. Keep gasoline away from appliance pilot lights, barbecues, electric appliances, power tools, etc.
- Do not overfill the fuel tank. Always check for fuel spills and immediately wipe them up. Spilled fuel is a fire hazard and causes environmental damage.

To add gasoline:

To ensure that this generator runs smoothly, use only FRESH, UNLEADED GASOLINE WITH AN OCTANE RATING OF 87 OR HIGHER. Unleaded gasoline produces fewer engine and spark plug deposits and extends the life of the exhaust system.

1. Confirm that this generator is on a level surface.
2. Unscrew fuel tank cap and set aside. (NOTE: The fuel tank cap may be tight and difficult to unscrew.)
3. Slowly add fresh, unleaded gasoline (with an octane rating 87 or higher) to the fuel tank. Be careful not to fill the fuel tank above the upper limit line. The fuel gauge, located on the top of this generator, indicates how much gasoline is currently in the fuel tank. NOTE: Because gasoline can expand, do not fill the fuel tank to the very top.
4. Securely tighten the fuel tank cap and immediately wipe up any spilled gasoline with a dry cloth.

| | |
|-------------------------------------|-----------------------------------------------------|
| Fuel Tank Capacity (gals /L) | 7 / 26.5 |
| Fuel Type | Fresh, Unleaded Gasoline Octane Rating 87 or Higher |

IMPORTANT:

- Use only UNLEADED gasoline with an octane rating of 87 or higher.
- Never use a mixture of oil and gasoline.
- Never use old and/or contaminated gasoline.
- Avoid getting dirt and/or water in the fuel tank.
- Gasoline can age in the fuel tank and make it difficult to start this generator. Never store this generator for extended time with gasoline in the fuel tank.

Step 2 – Connect the Battery

The generator does not come equipped from the factory with a battery. A battery must be installed before the electric start feature can be used.

(A 12 Volt motorcycle battery no larger than 7 1/4" length, 6 1/2" height, and 3" width is required for electric start of this generator.

(The ideal battery required is 7 1/8" L x 6" H x 3"W, 130 Min CCA Cold Cranking Amps)

Comparable brands/models are: Yuasa: YB9A-A, YB9-B or YB9L-B, Delco: CB9A-A, NAPA: 740-1872, 740-1858, 740-1837

Sears: 44043, 44356, 44045, Generic brand SLA-12V22

Brands/model numbers can change, this information is intended as a guide only, if your sparkplug needs to be replaced, please visit your local auto parts store for their recommendation, or call 1-866-460-9436 Monday - Friday, 8 AM - 4 PM Central Time for customer service for assistance

The battery case is located below the control panel.

Install the battery by using the two cables (one red and the other black) that are attached to the engine.

Disconnect all electrical loads from this generator before changing the battery.

Attach the red/positive cable to the positive terminal on the battery.

Attach the black /negative cable to the negative terminal on the battery.

Slide the battery into the battery case.

Step 3 - Ground the Generator

WARNING

Failure to properly ground this generator can result in electrocution.

Ground this generator by tightening the grounding nut against a grounding wire as illustrated in Figure 3. A No. 12 AWG (American Wire Gauge) stranded copper wire is generally an acceptable grounding wire. The other end of this grounding wire should be connected to a copper or brass grounding rod that is driven into the earth.

Grounding codes can vary by location. Contact a local electrician for information on grounding regulations for your area.

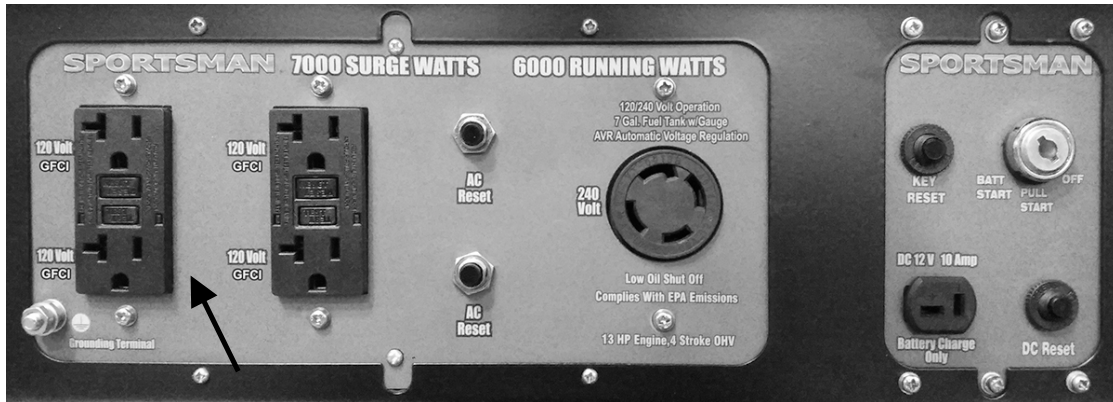

Figure 3 - Attaching the Grounding Wire to this Generator

Subsequent Use of this Generator

For subsequent uses of this generator after the first use, certain steps still must be completed to prepare it for operation.

IMPORTANT: Be familiar with the procedures described in the previous section titled “Using the Generator for the First Time” of this manual. If not, review this section now.

Step 1 - Verify Oil Level

Even though this generator is equipped with an automatic shutoff to protect it from damage due to low oil, it is important to check the oil level in the engine crankcase before each use to ensure that there is sufficient quantity.

1. Verify that this generator is on a level surface.
2. Unscrew the oil filler/dipstick cap from the engine.
3. With a dry cloth, wipe the oil off of the dipstick that is located on the inside of the cap.
4. Fully insert the dipstick without screwing the filler/dipstick cap and then remove again. There should be oil on the dipstick. If there is no oil on the dipstick, or oil is visible only at the very end of the dipstick, add oil until the engine crankcase is filled. (See “Changing/Adding Oil” in the “Maintenance/Care” section of this manual).
5. Confirm that the oil filler/dipstick cap is properly screwed in place when finished verifying the oil level.

NOTE: The oil capacity for this Generator is 1.2 Qt (US). (38 ounces)

| | |
|---------------------------------|--------------------------------------|
| Oil Capacity (Qt/ fluid oz. /L) | 1.2 / 38 / 1.13 |
| Oil Type Recommended | High Detergent Motor Oil, SAE 10W-30 |

Step 2 - Verify Gas Level

Before starting this generator, verify that there is sufficient gasoline in the fuel tank. The fuel gauge, located on the top of this generator, indicates the gas level currently in the fuel tank. If necessary, add fresh unleaded gasoline with an octane rating of 87 or higher according to “Step 2 - Add Gasoline” of the “Using this Generator for the First Time” section of this manual.

| | |
|------------------------------|-----------------------------------------------------|
| Fuel Tank Capacity (gals /L) | 7 / 26.5 |
| Fuel Type | Fresh, Unleaded Gasoline Octane Rating 87 or Higher |

WARNING

Gasoline and gasoline fumes are highly flammable and explosive. Handling fuel can result in serious injury or burns.

- Do not fill the fuel tank near a heat, sparks or an open flame. Keep gasoline away from appliance pilot lights, barbecues, electric appliances, power tools, etc.
- Always allow several minutes for the engine to cool before refueling.
- Do not overfill the fuel tank. Always check for fuel spills and immediately wipe them up. Spilled fuel is a fire hazard and causes environmental damage.

IMPORTANT:

- Use only fresh UNLEADED gasoline with an octane rating of 87 or higher.
- Never use old and/or contaminated gasoline.
- Never use a mixture of oil and gasoline.
- Avoid getting dirt and/or water in the fuel tank.
- Never store generator for extended time with gasoline in the fuel tank.

Step 3 - Ground the Generator

WARNING

Failure to properly ground this generator can result in electrocution.

Ground this generator by tightening the grounding nut against a grounding wire as previously illustrated in Figure 3. A generally acceptable grounding wire is a No. 12 AWG (American Wire Gauge) stranded copper wire. The other end of this grounding wire should be connected to a copper or brass grounding rod that is driven into the earth.

Grounding codes can vary by location. Contact a local electrician for information on grounding regulations for your area.

STARTING THE GENERATOR

STOP!

Before starting this generator, confirm that all the steps in the section titled, “Preparing the Generator for Use,” of this manual have been correctly completed. If unsure about how to perform any of these steps, call 1-866-460-9436, Monday - Friday, 8 AM - 4 PM Central Time for customer service.

CAUTION

Disconnect all electrical loads from this generator before attempting to start.

To start this generator:

1. Confirm that there are no electrical devices connected to this generator. Connected devices may increase the difficulty in starting the engine.
2. Confirm that this generator is properly grounded. (See “Ground the Generator” section of this manual.)
3. Turn the fuel valve to the “On” position.
4. Move the choke lever to the “Closed/Choke” position.
5. Insert the key into the ignition.
6. If a battery has been installed, go to step 6A. If the battery has NOT been installed, go to step 6B.
 - 6a. Turn the key to the “BATT START” position. Release the key when the generator starts.
 - 6b. Turn the key to the “PULL START” position. Slowly pull on the recoil starter handle, shown in Figure 6, until a slight resistance is felt. Then pull briskly to start the engine. Gently return the cord into the generator to avoid damage to the starter or housing. Never allow the cord to snap back.
7. If the engine fails to start, repeat step 6. NOTE: After repeated attempts to start the engine, consult the troubleshooting guide before attempting again. If problems persist, **call 1-866-460-9436, Monday - Friday, 8 AM - 4 PM Central Time.**
8. Once the engine has started and runs for about a minute, move the choke lever approximately half way towards the “Open/Run” position. Wait an additional 30 seconds and then move the choke lever completely over to the “Open/Run” position.
9. Allow this generator to run for several minutes before connecting any electrical devices.

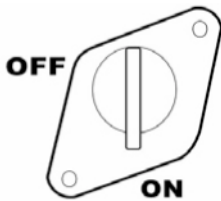

Figure 4 - Fuel Valve in the “on” position



Figure 5 - Choke Lever in the “closed” position. (Refer to the Generator Components chart to find the location of the Choke Lever.)



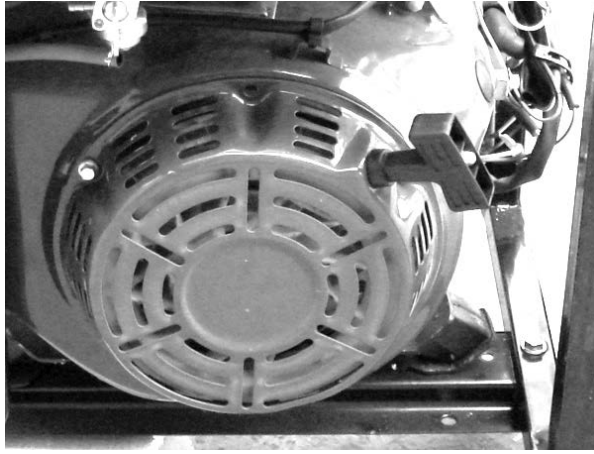

Figure 6 - Pull-cord for starting the engine.

CAUTION

Usage: Do not use fuel stabilizers with this generator, doing so could cause damage to the generator, or decrease the fuel and operating efficiency of the generator. You may choose to add a fuel conditioner to oxygenate the fuel and to help it run more efficiently.

Fuel Cock

The fuel cock is located between the fuel tank and carburetor. When the fuel cock is in the ON position, fuel is allowed to flow from the fuel tank to the carburetor. Be sure to return the fuel cock to the OFF position after stopping the engine.

Choke Rod

The choke is used to provide an enriched fuel mixture when starting a cold engine. It can be opened and closed by operating the choke rod manually. Pull the rod out toward CLOSED to enrich the mixture for cold starting

USING THE GENERATOR

After the engine has been running for several minutes, electrical devices may be connected to this generator.

AC Usage

Electrical devices running on AC current may be connected according to their wattage requirements. The rated (running) and surge wattage for this Generator is 6,000 and 7,000, respectively.

| | |
|--------------------------------|------|
| Rated (Running) Wattage | 6000 |
| Surge Wattage | 7000 |

The *rated (running) wattage* corresponds to the maximum wattage a generator can output on a continuous basis.

The *surge wattage* corresponds to the maximum amount of power a generator can output for a short time. Many electrical devices, such as a refrigerator, require short bursts of extra power for starting and stopping fan motors, etc., in addition to their listed rated wattage. Motorized devices typically require more than their rated wattage for startup. The surge wattage ability of a generator allows for this extra power requirement.

The total running wattage requirement of the electrical devices connected to a generator should not exceed the rated wattage of the generator itself. To calculate the total wattage requirement of the electrical devices to be connected, look up the rated (running) wattage of each device and add these numbers together to find the total wattage that all of the devices together will draw from the generator. If the total wattage of the selected devices exceeds the rated wattage of the generator, DO NOT connect all of the devices. Select a combination of the electrical devices that will have a total wattage less than or equal to the rated wattage for the generator, i.e., no more than 6000 for this Generator.

⚠ CAUTION

This generator can run at its surge wattage capacity for only a short time. Connect electrical devices requiring a rated (running) wattage equal to or less than the rated wattage of this generator. Never connect devices requiring a rated wattage equal to the surge wattage of a generator.

A device's rated (running) wattage should be listed somewhere on the device itself and/or in its manual. If the wattage specification for a device is not available, the wattage can be calculated by multiplying the Voltage requirement (120 or 240) by the Amperage drawn.

$$\text{Watts} = \text{Volts} \times \text{Amperes}$$

Or, the wattage required by a device can be estimated by using the following chart (see Figure 7). The chart provides only estimates and it is better to know the exact wattage of each electrical device to be powered by this generator.

⚠ WARNING

Usage: Consult a physician(s) before using this generator if using a pacemaker. Electromagnetic fields in close proximity to a heart pacemaker could cause a pacemaker to malfunction or fail. Caution is necessary when near the engine's recoil starter.

⚠ CAUTION

Usage: Prolonged exposure to high noise levels can be hazardous to hearing. Always wear ANSI-approved hearing protection when operating or working around the generator when it is running.

CAUTION

Usage: This generator is not intended to power sensitive electronic equipment such as TVs, DVD players, stereos, desktop computers or laptop computers without the use of an appropriate line conditioner and/or surge protector (both not included). Sensitive electronic equipment should be operated on approved inverter type generators or pure sine wave generators. For additional information consult the devices operation manual or call customer service at 1-866-460-9436 Monday - Friday, 8 AM - 4 PM Central Time.

⚠ WARNING

Usage: Avoid the use of extension cords if possible. If you choose to use them, be sure they are sized adequately to handle the flow of electricity. An undersized cord can overheat, short out and cause a fire.

| Electrical Device | Rated (Running) Watts | Additional Surge Watts |
|------------------------------------|-----------------------|------------------------|
| air compressor (1 HP) | 1500 | 3000 |
| air compressor (1 - 1/2 HP) | 2500 | 2500 |
| airless sprayer (1/3 HP) | 600 | 1200 |
| box fan | 300 | 600 |
| clock radio AM/FM | 300 | 0 |
| coffee maker | 1500 | 0 |
| computer w/17 inch monitor | 800 | 0 |
| deep freezer | 500 | 500 |
| electric drill (1/2 HP) | 1000 | 1000 |
| DVD/CD player or VCR | 100 | 0 |
| furnace fan blower (1/2 HP) | 800 | 1300 |
| garage door opener (1/2 HP) | 480 | 520 |
| hot plate | 2500 | 0 |
| light bulb (75 watt) | 75 | 0 |
| microwave oven (1000 watt) | 1000 | 0 |
| quartz halogen work light | 1000 | 0 |
| refrigerator/freezer (18 Cu. Ft.) | 800 | 1600 |
| saw - circular (7 1/4 inch) | 1500 | 1500 |
| saw - miter (10 inch) | 1800 | 1800 |
| saw - radial arm | 2000 | 2000 |
| saw - reciprocating | 960 | 1040 |
| saw - table/radial (10 inch) | 2000 | 2000 |
| security system | 180 | 0 |
| stereo receiver | 450 | 0 |
| electric stove - single element | 1500 | 0 |
| sump pump | 800 | 1200 |
| table planer (6 inch) | 1800 | 1800 |
| television (27 inch color) | 500 | 0 |
| electric water heater (40 gallon) | 4000 | 0 |
| well water pump (1/3 HP) | 1000 | 2000 |
| window air conditioner (10000 BTU) | 1200 | 1800 |
| window fan | 300 | 600 |

Figure 7 - Estimated wattage requirements for common electrical devices.

Connect electrical devices to this generator according to the following procedure:

1. Allow the engine to run for several minutes after it has been started.
2. Confirm that the electrical device is switched off prior to plugging it into this generator.

⚠ CAUTION

Connect only electrical devices that are in good working order. Faulty devices or power cords present the risk of electrical shock. Immediately turn off and disconnect any device that commences to operate abnormally, sluggish or abruptly stops. Determine if the problem was the device or the rated load capacity of this generator has been exceeded.

NOTE: Plug appliances into the correct outlet. Connect standard 120 Volt, single phase, 60 Hz loads to the 120 Volt outlet. Connect 240/120Volt, single phase, 60Hz loads with a NEMA L14-30 plug only to the 240/120 Volt outlet. See Figure 8 for an illustration of these outlets.

⚠ CAUTION

Even though this Generator has an overall rated wattage of 6000, do not attempt to draw more than 6400 Watts (20 A) from any ONE of the 120 Volt outlets. Draws higher than 6400 Watts (20 A) will damage this generator and void the warranty.

3. Make sure AC Reset button is pressed in.

NOTE: While this generator is running, power is available from either the standard 120 Volt outlets or the 240/120 Volt outlet. Both 120 Volts and 240 Volts can be simultaneously drawn from this generator.

4. Turn on the connected electrical devices beginning with the device with the highest rated wattage requirement and then each additional device with the next lower rated wattage requirement.

⚠ CAUTION

Do not connect 50Hz or 3-phase loads to this generator.

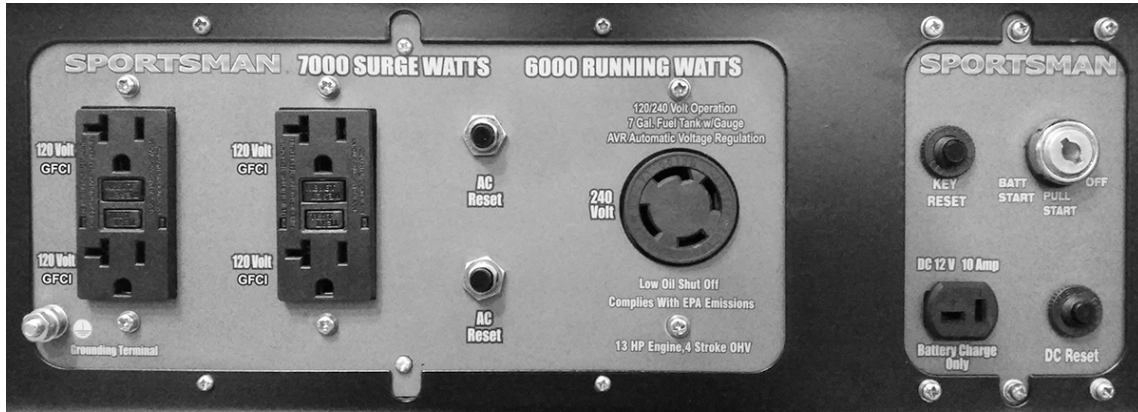

Figure 8 - Outlets Available on this Generator, from left to right, 120V AC, 240/120 AC and 12V DC.

SOME NOTES ABOUT POWER CORDS

Long or thin cords can require more wattage from a generator to power an electrical device. Figure 9 shows the recommended cords according to the power requirement of the electrical device. When using cords that exceed these specifications, allow for the electrical device to have a slightly higher rated wattage requirement.

| Device Requirements | | | Max. Cord Length (ft) by Wire Gauge | | | | |
|---------------------|--------------|--------------|-------------------------------------|----------|----------|----------|----------|
| Amps | Watts (120V) | Watts (240V) | #8 wire | #10 wire | #12 wire | #14 wire | #16 wire |
| 2.5 | 300 | 600 | NR | 1000 | 600 | 375 | 250 |
| 5 | 600 | 1200 | NR | 500 | 300 | 200 | 125 |
| 7.5 | 900 | 1800 | NR | 350 | 200 | 125 | 100 |
| 10 | 1200 | 2400 | NR | 250 | 150 | 100 | 50 |
| 15 | 1800 | 3600 | NR | 150 | 100 | 65 | NR |
| 20 | 2400 | 4800 | 175 | 125 | 75 | 50 | NR |
| 25 | 3000 | 6000 | 150 | 100 | 60 | NR | NR |
| 30 | 3600 | 7200 | 125 | 65 | NR | NR | NR |
| 40 | 4800 | 9600 | 90 | NR | NR | NR | NR |

NR = Not Recommended.

Figure 9 - Maximum Extension Cord Lengths by Power Requirement

DC Usage

⚠ CAUTION

The DC outlet is only for recharging 12 Volt automotive-type batteries. Do not connect any other device to this outlet.

⚠ CAUTION

Use this generator only for recharging 12 Volt batteries. NEVER attempt to jumpstart a car with this generator.

⚠ DANGER

Failing to use the correct procedure can cause a battery to explode, seriously injuring anyone nearby. Keep heat, sparks, flame and smoking materials away from the battery.

To connect 12 Volt batteries to the DC outlet:

1. Allow the engine to run for several minutes after it has been started.
3. Make sure DC Reset button is pressed in.

⚠ DANGER

Storage batteries emit highly explosive hydrogen gas when charged.

Batteries also contain acid, which can cause severe chemical burns.

- Do not allow open flames or cigarettes nearby for several minutes after charging a battery.
- Always wear protective goggles and rubber gloves when charging a battery.
 - If battery acid gets on the skin, flush with water.
 - If battery acid gets in the eyes, flush with water and immediately call a physician.
 - If battery acid is swallowed, drink large quantities of milk and immediately call a physician.

STOPPING THE GENERATOR

To stop this generator:

1. Turn off all connected electrical devices and then unplug them.
2. Allow this generator to run for several more minutes with no electrical devices connected to help stabilize the temperature of this generator.
3. Turn the key to the "off" position.
4. Turn the fuel valve to the "off" position.

⚠ WARNING

Allow this generator to cool down before touching areas that become hot during operation.

⚠ CAUTION

Allowing gasoline to sit in this generator's fuel tank for extended time without use can increase the difficulty in starting this generator in the future. Never store this generator for extended time with gasoline in the fuel tank.

MAINTENANCE/CARE

Proper routine maintenance of this generator is essential for safe, economical, and trouble-free operation. It will help prolong the life of this generator as well as help reduce air pollution. Perform maintenance checks and procedures according to the schedule in Figure 10.

STOP!

If you have questions about maintenance procedures described in this manual, call 1-866-460-9436 , Monday - Friday, 8 AM - 4 PM Central Time.

⚠ CAUTION

Never perform maintenance procedures while this generator is running. Allow this generator to cool before commencing any maintenance procedures. Keep heat, sparks and flame away.

⚠ WARNING

Improper maintenance and/or failure to correct any problems prior to operating this generator can cause a malfunction which could cause death or serious injury. Always follow the inspection and maintenance recommendations and schedules in this manual.

Recommended Maintenance Schedule

| | | Each Use | Every Month or Each 20 Hrs | Every 3 Months or Each 50 Hrs | Every 6 Months or Each 100 Hrs | Every Year or Each 300 Hrs |
|------------|------------------|----------|----------------------------|-------------------------------|--------------------------------|----------------------------|
| Engine Oil | Check Level | X | | | | |
| | Replace | | X (first use) | | X | |
| Air Filter | Check | X | | | | |
| | Clean | | | X | | |
| Spark Plug | Check/Clean | | | | X | |
| Fuel Tank | Verify Gas Level | X | | | | |
| | Clean | | | | | X |

Figure 10 - Recommended maintenance schedule

Cleaning the Generator

Always try to use this generator in a cool dry place. If this generator becomes dirty, the exterior can be cleaned with a damp cloth, soft brush, vacuum and/or pressurized air.

Never clean this generator with a bucket of water and/or a hose as water can get inside and cause a short circuit or corrosion.

Never use gasoline to clean parts of this generator.

Checking the Oil Level

Even though this generator is equipped with an automatic shutoff to protect it from damage due to low oil, it is important to check the oil level in the engine crankcase before each use to ensure that there is a sufficient quantity.

To check the oil level:

1. Verify that this generator is shut down and on a level surface.
2. Unscrew the oil filler/dipstick cap from the engine as illustrated in Figure 11.
3. With a dry cloth, wipe the oil off of the dipstick that is located on the inside of the cap.
4. Insert the dipstick as if replacing the cap and then remove again. There should be oil on the dipstick. If there is no oil on the dipstick, or oil is visible only at the very end of the dipstick, add oil until the engine crankcase is filled (see "Changing/Adding Oil" in this section of this manual).
5. Confirm that the oil filler/dipstick cap is properly in place when finished verifying the oil level.

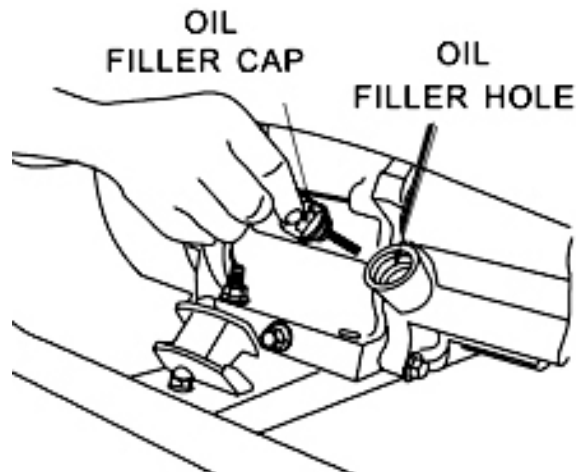

Figure 11 - Checking the Oil

Changing/Adding Oil

The oil level in this generator should be checked before each use. (See Figure 10.) When the oil level is low, add oil until the level is sufficient to operate this generator.

The oil should be changed after the first 20 hours of operation. The oil should then be changed every 6months, or for every 100 hours of use time.

The oil capacity for this Generator engine is 1.2 Qt. (38 fluid oz.) (1.13 L).

ADD OIL UNTIL IT IS ALMOST OVERFLOWING. THE LOW-OIL SENSOR IS VERY SENSITIVE AND THE ENGINE WILL NOT RUN IF THE OIL IS LOW. START WITH 38 OUNCES, THEN ADD MORE UNTIL ALMOST OVERFLOWING.

TROUBLESHOOTING: IF THE GENERATOR WILL NOT START, DOUBLE CHECK THAT THE OIL LEVEL IS COMPLETELY FULL AND ALMOST OVERFLOWING.

To drain the oil from this generator:

It is necessary to drain the oil from the crankcase only if it has become contaminated with water and/or dirt.

1. Place a bucket underneath this generator to catch oil as it drains.
2. Using a 12 mm hex wrench, unscrew the oil drain plug located on the crankcase underneath the oil filler/dipstick cap as illustrated in Figure 12.
3. Allow all the oil to drain from this generator.
4. Replace the oil drain plug and tighten with a 12 mm hex wrench.

NOTE: Never dispose of used motor oil in the trash, down a drain or on the ground. Put oil in a sealed container and contact your local recycling center or auto garage to arrange oil disposal.

To add oil to the engine crankcase:

1. Confirm that this generator is on a level surface.
2. Unscrew the oil filler/dipstick cap from the engine as illustrated in Figure 11 above.
3. Using a funnel, add high detergent motor oil to fill the engine crankcase to the correct quantity. SAE10W-30 oil is recommended for general use.

When the engine crankcase is full, the oil level should reach the lower lip of the oil filling opening as shown in Figure 13.

| | |
|-------------------------------|-------------------------------------|
| Oil Capacity (Qt/fluid oz./L) | 1.2 / 38 / 1.13 |
| Oil Type Recommended | High Detergent Motor Oil, SAE10W-30 |

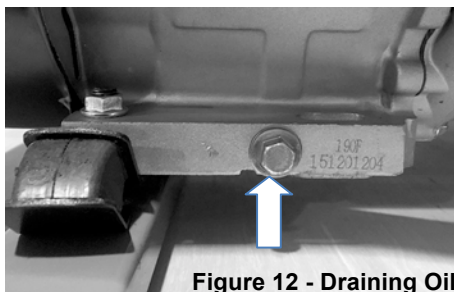

Figure 12 - Draining Oil



Figure 13 - Adding Oil

Air Filter Maintenance

Routine maintenance of the air filter helps maintain proper airflow to the carburetor. Occasionally verify that the air filter is free of excessive dirt. The air filter will require more frequent cleaning when operating this generator in extremely dusty areas.

To clean the air filter, remove the foam filter element from the generator and wash it in warm water and household dish detergent. Thoroughly rinse and dry. Pour a small amount of motor oil onto the filter, ring out ALL excess oil, and reinstall the foam filter element in the generator.

Unscrew the bolts, or unsnap the clips at the top and bottom of the air filter cover, located below the choke lever, to access the foam filter element.

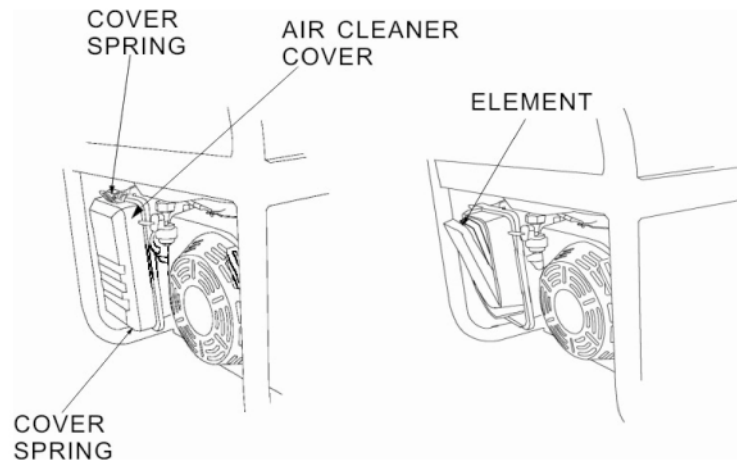

Figure 14 - Removing the Air Filter Casing.

Spark Plug Maintenance

The spark plug is essential for proper engine operation. The spark plug should be intact, free of deposits, and properly gapped. A bad or incorrectly installed spark plug can cause engine damage. To inspect the spark plug:

| | |
|------------------------|---------------------|
| Spark Plug Type | F6TC |
| Spark Plug Gap (in/mm) | 0.028-0.031/0.7-0.8 |

1. Remove the spark plug by pulling on the spark plug cap.
2. Unscrew the spark plug from this generator by using the included spark plug wrench as illustrated in Figure 16.
3. Visually inspect the spark plug. If it is cracked and/or chipped, discard and install a new spark plug. A F6RTC spark plug, such as NGK BPR5ES, is recommended.
4. Measure the spark plug electrode gap with a gauge. The gap should be 0.028-0.031in (0.7-0.8mm). (See Figure 17.)
5. If re-using the spark plug, use a wire brush to clean any dirt from around the spark plug base and then re-gap the spark plug.
6. Screw the spark plug back into place on this generator by using the included spark plug wrench.
7. Replace the spark plug cap.

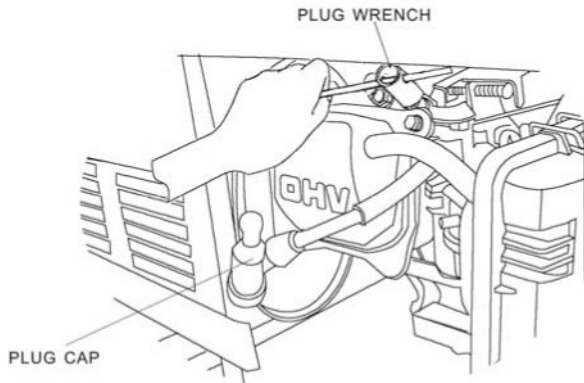

Figure 16 - Removing the Spark Plug

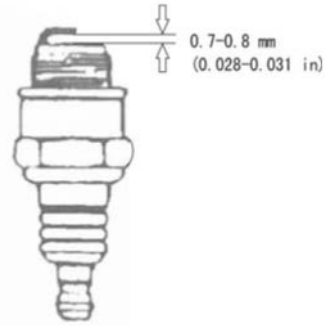

Figure 17 - Measuring the Spark Plug Gap

To store this generator for extended time, drain the gasoline from the carburetor AND fuel tank.

To drain gasoline from this generator:

1. Turn the fuel valve to the “off” position and let the engine run until it stops.
2. Remove the fuel filter cup.
3. Empty the fuel filter cup of any fuel.
4. Place a receptacle underneath this generator to catch gasoline as it drains.
5. Turn the fuel valve to the “on” position and allow all gasoline to drain.
6. Turn the fuel valve to the “off” position.
7. Replace the fuel filter cup.
8. Store the drained gasoline in a suitable place.

CAUTION

Do not store gasoline for more than 3 months.

STORAGE/TRANSPORT PROCEDURES

CAUTION

Never place any type of storage cover on this generator while it is still hot.

When transporting or storing this generator for extended time:

- Allow generator to fully cool before moving it. A hot engine and exhaust system can burn you and ignite some materials.
- Disconnect the battery used for the electric start feature of this generator, first disconnecting the black cable and then the red cable.
- Empty the fuel tank. (See “Emptying the Fuel Tank” in the “Maintenance/Care” section.)
- Turn the fuel valve to the “off” position.
- Disconnect the spark plug. (See Figure 16, Removing the spark plug.)
- Do not obstruct any ventilation openings.
- Do not drop or strike this generator while moving it.
- Store this generator in a cool dry area, free of excessive dust.

| Storage Time | Recommended Storage Procedure (which will help prevent difficult starts) |
|--------------------|----------------------------------------------------------------------------------------------------------------------------------------------------------------|
| Less than 1 month | No storage procedure required. |
| 1 to 2 months | Fill with fresh gasoline and add gasoline conditioner |
| 2 months to 1 year | Empty the fuel tank. (See “Emptying the Fuel Tank” in the “Maintenance/Care” section.) |
| 1 year or more | Empty the fuel tank. (See “Emptying the Fuel Tank” in the “Maintenance/Care” section.) Disconnect the spark plug. (See Figure 16, Removing the spark plug.) |

TROUBLESHOOTING

IMPORTANT: If trouble persists, call our customer help line at 1-866-460-9436, Monday - Friday, 8 AM - 4 PM Central Time.

| Symptom | Cause | Solution |
|-----------------------------------------------------------------------|---------------------------------------------------------|-----------------------------------------------------------------------------------------------------------------------------------------------------------------------------------------------------------------------------------------------|
| Engine will not start. | The key is set to "off." | Turn the key to "BATT START" or "PULL START" |
| | Fuel valve is turned to "closed." | Turn fuel valve to "open." |
| | Choke is set to "open/run" | Choke is set to "close/choke". |
| | Engine is out of gasoline. | Add gasoline. |
| | Engine is filled with contaminated and/or old gasoline. | Drain gasoline from the engine and add new gasoline. |
| | Spark plug is dirty. | Clean spark plug. |
| | Spark plug is broken. | Replace spark plug. |
| | Generator is not on level surface. | Move generator to a level surface to prevent triggering the low oil shutdown. |
| | Oil is low. | Add or replace oil. |
| Generator runs but does not support all connected electrical devices. | Generator is overloaded. | Reduce draw on generator to within this generator's rated wattage by reducing number of connected electrical devices. |
| | Short in one of the connected devices. | Disconnect any faulty or short-circuited electrical loads. |
| | Air filter is dirty. | Clean or replace air filter. |
| | Loose wiring harness connection | Turn off generator, then check wiring behind control panel and at the end of generator for loose connection. If wires are loose, tighten the screws and/or nuts. Be certain the plug in connectors are pushed together all the way. |
| Engine runs but there is no electrical output. | Reset button(s) is (are) "off." | Push reset button(s) to "on." |
| | Loose wiring harness connection | Turn off generator, then check wiring behind control panel and at the end of generator for loose connection. If wires are loose, tighten the screws and/or nuts. Be certain the plug in connectors are pushed together all the way. |
| | Bad connecting wires/cables. | Try a different extension cord. |
| | Bad electrical device connected to generator. | Disconnect device, try connecting another device. |
| | Carbon Brushes are worn down | Turn off generator, then look at the brush holder at the end of the generator to determine if the brushers are still against the copper bands on the end of the rotor. If they are worn down, replace the 2 wires the same way they came off. |
| | AVR shorted out or burned out | Turn off the generator, then remove the 2 screws at the end of the generator. Look for the burn spots on the back side of the AVR. If there is burn spots, replace the AVR. |

SPECIFICATIONS

7000 Surge Watts / 6000 Running Watts Electric Start Portable Generator

Generator

| | |
|------|----------------------------------------------------------------------|
| Type | Brush, Revolving Magnetic Field, Self Exciting, 2-Pole, Single Phase |
|------|----------------------------------------------------------------------|

AC Output

| | |
|----------------------|-----------------------------------|
| Rated Wattage (W) | 6000 |
| Surge Wattage (W) | 7000 |
| Rated Voltage (V) | 120/240 |
| Rated Amperage | 25A+25A at 120 V 25 A at 240 V |
| Rated Frequency (Hz) | 60 |
| Phase | Single |

DC Output

| | |
|------------------------------|-----|
| Voltage (V) | 12 |
| Circuit Breaker Amperage (A) | 8.3 |

Dimensions and Weight

| | |
|--------------------|------------------------------------|
| Dimensions (in.) | 28 Length, 20.0 Width, 23.2 Height |
| Gross Weight (lbs) | 203 |
| Net Weight (lbs) | 192 |

Engine

| | |
|--------------------------------------------------------------------------------|--------------------------------------------------------------|
| Approvals | EPA |
| Engine Model (HP) | 13 |
| Engine Type | 4-stroke OHV single cylinder with forced air cooling system. |
| Ignition System | Non-contact transistor (T.C.I.) |
| Starting System | Recoil & Electric |
| Displacement (cm ³) | 389 |
| Max Output (hp/rpm) | 13/3600 |
| Fuel Tank Capacity (Fresh, Unleaded gasoline, 87 or higher octane) (US gal./L) | 7 / 25.2 |
| Continuous Operating Hours | 12 @ 50% Load |
| Oil Capacity (SAE10W-30) (fl oz./Qts/L) | 38 / 1.2 / 1.13 |
| Run Time on 50% Load (hours) | 12 |
| Noise Rating (at 7 m, 0% load) (dB) | <86 |

PARTS DIAGRAM

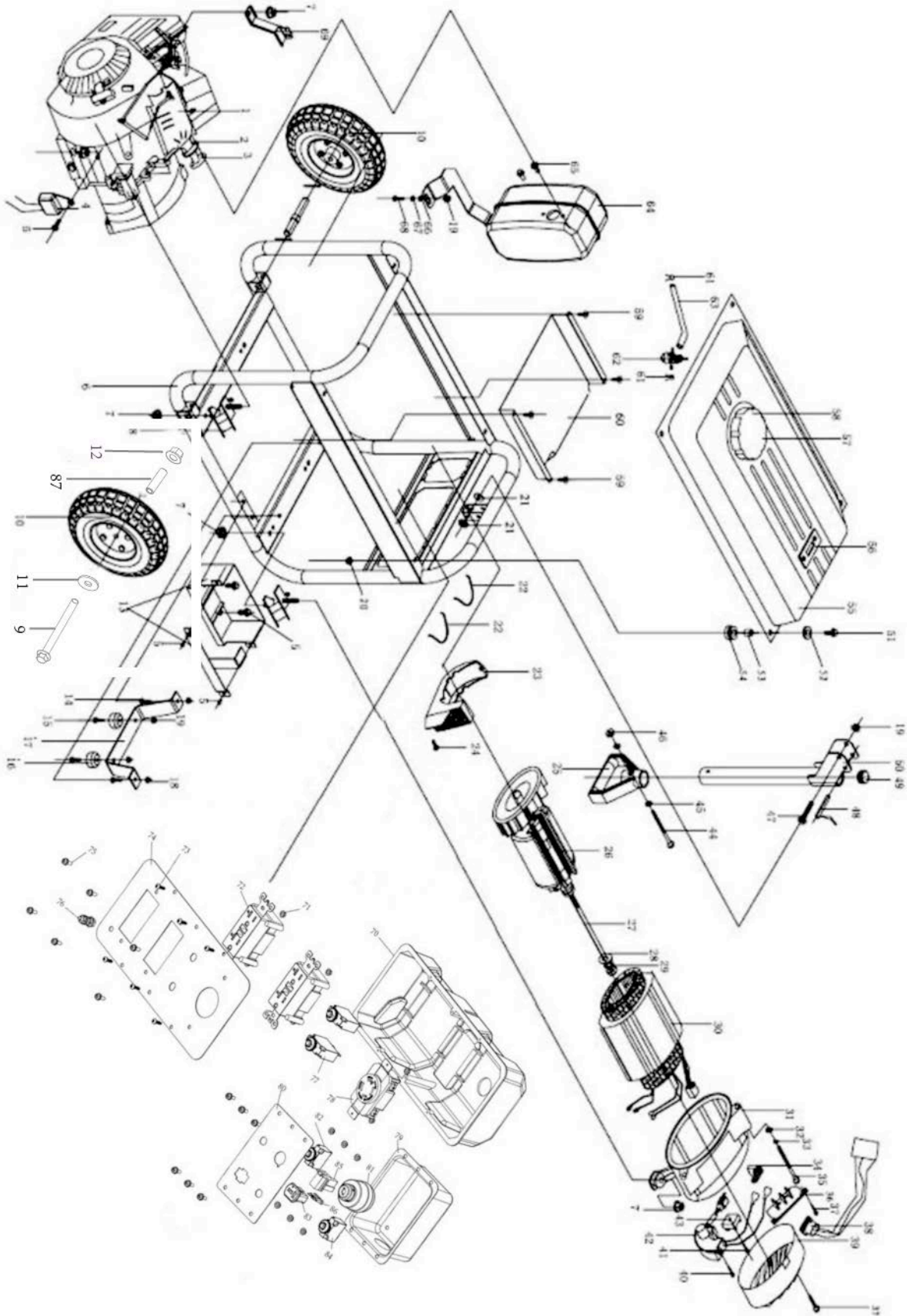

PARTS LIST

| Item | Part | Description | Qty | Item | Part | Description | Qty |
|------|-------------------------|-------------------------|-----|------|-------------------|--------------------------|-----|
| 1 | Q07-00-00 | Engine Assembly | 1 | 48 | CG500-020400T2 | Pin | 1 |
| 2 | G014F-07-5 | Gasket outlet | 2 | 49 | G023F-60-4 | Handle unit | 1 |
| 3 | G023F-07-01 | Exhaust pipe | 1 | 50 | G023F-60-01 | Handle unit | 1 |
| 4 | G04-11-09 | Signal Magnifier | 1 | 51 | GB/T5789 | Bolt M6×25 | 4 |
| 5 | GB/T5789 | Bolt M6×12 | 7 | 52 | GB/T97.1 | Washer φ25×φ6×1.5 | 4 |
| 6 | G023F-02-01 | Frame Assy | 1 | 53 | G010G-12-2 | Filling brush, fuel tank | 4 |
| 7 | GB/T6177.1 | Nut M10*1.25 | 8 | 54 | G010G-12-1 | Fuel Tank Cushion | 4 |
| 8 | G014F-00-01 | Shock Absorption | 4 | 55 | G023F-12-01 | Fuel Tank Assy | 1 |
| 9 | GB16674 M10*1.25*105 | Flange Bolt | 2 | 56 | G010G-12-05 | Fuel sensor | 1 |
| 10 | 10*4.10/3.50-4 | Solid Wheel Kit 10" | 2 | 57 | G010G-12-03 | Fuel filler | 1 |
| 11 | GB96 10 | Big Washer | 2 | 58 | G010G-12-02 | Fuel filler cap complete | 1 |
| 12 | GB6177.1 M10*1.25 | Flange Nut | 2 | 59 | GB/T846 | Screw ST3.5*13 | 8 |
| 13 | G023F-60-02 | Storage Battery Tray | 1 | 60 | G023F-02-1 | Wire Flat | 1 |
| 14 | GB/T16674 | Bolt M8×20 | 2 | 61 | G010G-12-5 | Tube clip | 2 |
| 15 | GB/T5789 | Bolt M8×25 | 2 | 62 | G023F-12-02 | Tank Cock | 1 |
| 16 | G023F-60-2 | Feet | 2 | 63 | G023F-12-1 | Fuel Pipe | 1 |
| 17 | G002D-00-03 | Underprop | 1 | 64 | G023F-07-01 | Muffler | 1 |
| 18 | GB/T6177.1 | Nut M8 | 6 | 65 | GB/T5783 | Bolt M8×20 | 2 |
| 19 | GB/T6184 | Nut M8 | 3 | 66 | GB/T93 | Spring washer 8 | 5 |
| 20 | GB/T6177.1 | Nut M6 | 4 | 67 | GB/T95 | Washer 8 | 8 |
| 21 | G010G-60-4 | washer | 2 | 68 | GB/T5789 | Bolt M8*40 | 1 |
| 22 | G023F-00-1 | Wire Clip | 2 | 69 | G014F-00-02 | Air Cleaner Stay | 1 |
| 23 | G014F-01-05 | Cover | 1 | | | | |
| 24 | GB/T5789 | Bolt M6×10 | 3 | 70 | 519707001 | AC Panel Case | 1 |
| 25 | G023F-60-1 | Handle unit | 1 | 71 | GB6177.1 M4 | Flange Nut | 12 |
| 26 | G014F-01-02 | Rotor | 1 | 72 | GFCI-20A/120V | GFCI Socket | 2 |
| 27 | GB/T5782 | Bolt M10*1.25*265mm | 1 | 73 | GB845 ST3.5×12 | Tapping Screw | 6 |
| 28 | GB/T95 | Plain washer 10 | 1 | 74 | GEN7000E04-02GFCI | AC Panel | 1 |
| 29 | GB/T93 | Spring washer 10 | 1 | 75 | GB9074.4 M4*12 | Screw assy | 12 |
| 30 | G023F-01-01 | Stator | 1 | 76 | GB5782.00 M6×18 | Bolt Assy,Earth | 1 |
| 31 | G014F-01-1 | Rear Cover | 1 | 77 | 98-25A | Protector | 2 |
| 32 | GB/T95 | Washer 6 | 4 | 78 | L14-30 | AC Socket | 1 |
| 33 | GB/T93 | Spring washer 6 | 4 | 79 | GEN7000E04-03T | Control Panel Case | 1 |
| 34 | G014F-01-03 | Brush Assembly | 1 | 80 | GEN7000E04-04 | Control Panel | 1 |
| 35 | GB/T16674 | Bolt M6×185 | 4 | 81 | KJ5000A04-05 | Ignition Key | 1 |
| 36 | G010G-01-03 | Connecting plate | 1 | 82 | 88-8A | Protector | 1 |
| 37 | GB/T16674 | Screw M5×12 | 5 | 83 | YG T12-10 | DC Socket | 1 |
| 38 | G010G-11-2 | Boot | 1 | 84 | 88-5A | Protector | 1 |
| 39 | G014F-01-2 | Cover | 1 | 85 | GEN9000DF04-10.00 | Rectifier | 1 |
| 40 | GB/T16674 | Screw M5×16 | 3 | 86 | F2-PG | Fuse | 1 |
| 41 | GB/T9074.4 | Screw M5*20 | 1 | 87 | SF7000F03-05 | Wheel Spacer | 2 |
| 42 | G014F-01-04 | Voltage regulator | 1 | | | | |
| 43 | G010G-11-07 | BRIDGE RECTIFIER | 1 | | | | |
| 44 | GB/T818 | Screw M5*50 | 1 | | | | |
| 45 | GB/T95 | Washer 5 (φ 16* φ 5*1) | 2 | | | | |
| 46 | GB/T6184 | Nut M5 | 1 | | | | |
| 47 | GB/T5789 | Bolt M8*50 | 1 | | | | |

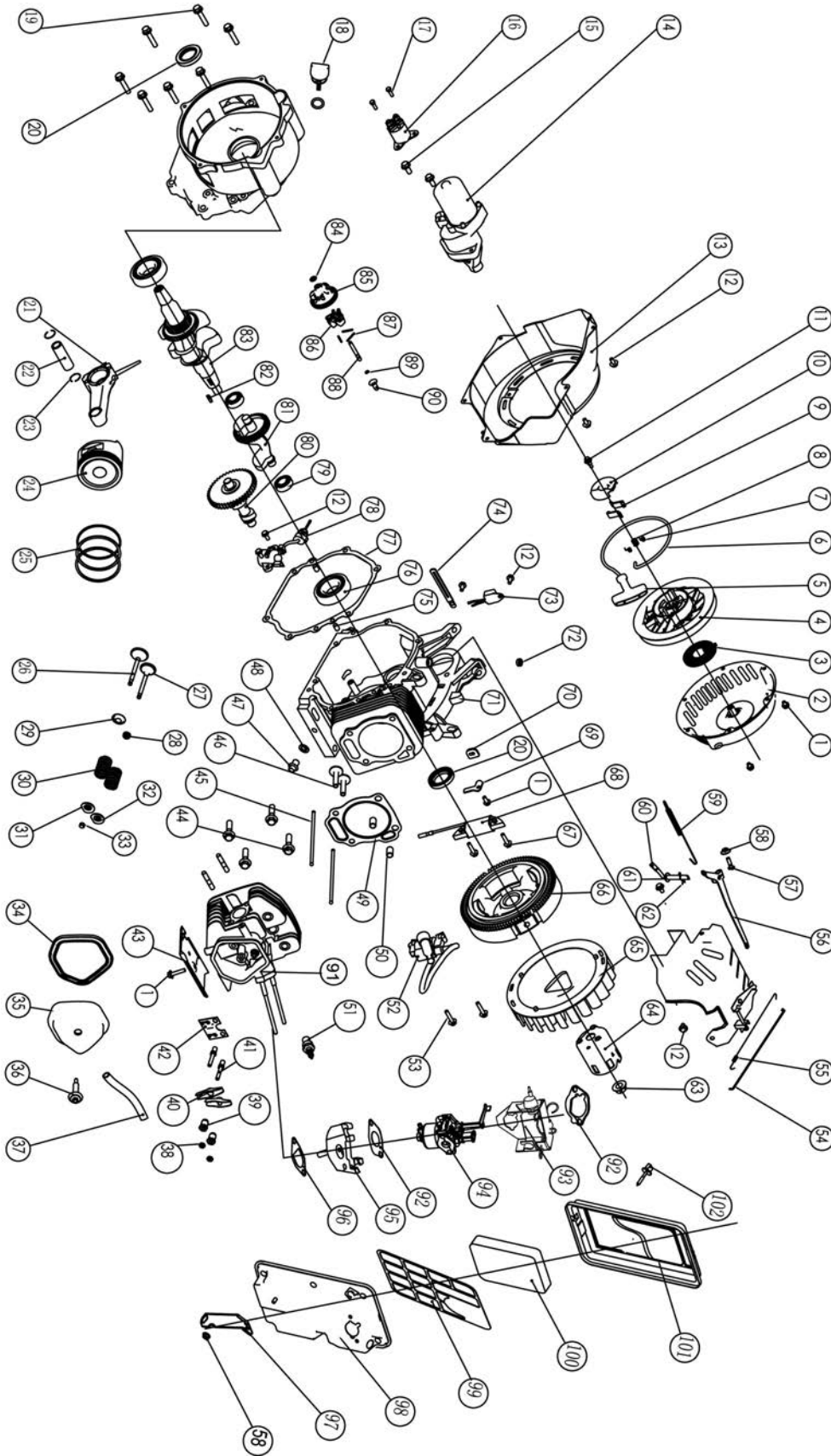

PARTS LIST

| No | Part # | Name | Qty | No | Part # | Name | Qty |
|----|------------|---------------------------|-----|-----|-------------|-----------------------------|-----|
| 1 | A188F-1-01 | Flange bolt M6x8 | 3 | 52 | A188F-1-52 | Ignition Assy | 1 |
| 2 | A188F-1-02 | Recoil Starter Case Cover | 1 | 53 | A188F-1-53 | Bolt M6x25 | 2 |
| 3 | A188F-1-03 | Starter Return Spring | 1 | 54 | A188F-1-54 | Governor Rod | 1 |
| 4 | A188F-1-04 | Recoil Starter Reel | 1 | 55 | A188F-1-55 | Spring | 1 |
| 5 | A188F-1-05 | Recoil Starter Knob | 1 | 56 | A188F-1-56 | Governor Arm | 1 |
| 6 | A188F-1-06 | Recoil Starter Rope | 1 | 57 | A188F-1-57 | Governor Arm Bolt | 1 |
| 7 | A188F-1-07 | Ratchet Spring | 2 | 58 | A188F-1-58 | Nut M6 | 5 |
| 8 | A188F-1-08 | Ratchet Guide Spring | 1 | 59 | A188F-1-59 | Governor Spring | 1 |
| 9 | A188F-1-09 | Ratchet Starter | 2 | 60 | A188F-1-60 | Governor Arm Shaft | 1 |
| 10 | A188F-1-10 | Ratchet Guide | 1 | 61 | A188F-1-61 | Washer 8.2x17x0.8 | 1 |
| 11 | A188F-1-11 | Ratchet Guide Bolt | 1 | 62 | A188F-1-62 | Pin Clip | 1 |
| 12 | A188F-1-12 | Flange Bolt M6x12 | 10 | 63 | A188F-1-63 | Nut M16x1.5 | 1 |
| 13 | A188F-1-13 | Fan Cover Comp | 1 | 64 | A188F-1-64 | Starter Hub | 1 |
| 14 | A188F-1-14 | Start Motor | 1 | 65 | A188F-1-65 | Cooling Fan | 1 |
| 15 | A188F-1-15 | Flange Bolt M8x35 | 2 | 66 | A188F-1-66 | Flywheel Comp | 1 |
| 16 | A188F-1-16 | Relay | 1 | 67 | A188F-1-67 | Flange bolt M6x35 | 2 |
| 17 | A188F-1-17 | Flange Bolt M5x20 | 2 | 68 | A188F-1-68 | Charge coil | 1 |
| 18 | A188F-1-18 | Oil Filler Cap | 1 | 69 | A188F-1-69 | Wire Flat | 1 |
| 19 | A188F-1-19 | Flange Bolt M8x40 | 7 | 70 | A188F-1-70 | Packing | 1 |
| 20 | A188F-1-20 | Oil Seal | 2 | 71 | A188F-1-71 | Crankcase Assy | 1 |
| 21 | A188F-1-21 | Connecting Rod Assembly | 1 | 72 | A188F-1-72 | Oil Seal | 1 |
| 22 | A188F-1-22 | Piston Pin | 1 | 73 | A188F-1-73 | Signal Magnifier | 1 |
| 23 | A188F-1-23 | Piston Pin Clip | 2 | 74 | A188F-1-74 | Wire Clip | 1 |
| 24 | A188F-1-24 | Piston | 1 | 75 | A188F-1-75 | Locating Pin 8x14 | 2 |
| 25 | A188F-1-25 | Piston Oil Seal Ring Comp | 1 | 76 | A188F-1-76 | Radial Ball Bearing 6207/C3 | 2 |
| 26 | A188F-1-26 | EX, Valve | 1 | 77 | A188F-1-77 | Crankcase Packing Washer | 1 |
| 27 | A188F-1-27 | IN, Valve | 1 | 78 | A188F-1-78 | Oil Level Switch Assy | 1 |
| 28 | A188F-1-28 | Valve Oil Seal | 1 | 79 | A188F-1-79 | Radial Ball Bearing 6202/P6 | 2 |
| 29 | A188F-1-29 | Valve Spring Washer | 1 | 80 | A188F-1-80 | Camshaft Comp | 1 |
| 30 | A188F-1-30 | Valve Spring | 2 | 81 | A188F-1-81 | Balance Gear | 1 |
| 31 | A188F-1-31 | EX, Valve Spring Retainer | 1 | 82 | A188F-1-82 | Key | 1 |
| 32 | A188F-1-32 | IN, Valve Spring Retainer | 1 | 83 | A188F-1-83 | Crankshaft Comp | 1 |
| 33 | A188F-1-33 | Ex, Valve Cap | 1 | 84 | A188F-1-84 | Governor Washer | 1 |
| 34 | A188F-1-34 | Head Cover Packing Washer | 1 | 85 | A188F-1-85 | Governor Gear | 1 |
| 35 | A188F-1-35 | Head Cover Comp | 1 | 86 | A188F-1-86 | Governor Weight | 3 |
| 36 | A188F-1-36 | Head Cover Bolt Comp | 1 | 87 | A188F-1-87 | Governor Weight Pin | 3 |
| 37 | A188F-1-37 | Tube | 1 | 88 | A188F-1-88 | Governor Shaft | 1 |
| 38 | A188F-1-38 | Locking Arm Nut | 2 | 89 | A188F-1-89 | Governor Shaft Clip | 1 |
| 39 | A188F-1-39 | Pivot Adjusting Nut | 2 | 90 | A188F-1-90 | Governor Slider | 1 |
| 40 | A188F-1-40 | Valve Rocker Arm | 2 | 91 | A188F-1-91 | Cylinder Head Comp | 1 |
| 41 | A188F-1-41 | Pivot Bolt | 2 | 92 | A188F-1-92 | Carburetor gasket | 1 |
| 42 | A188F-1-42 | Push Rod Guide Plate | 1 | | A188F-1-103 | Carburetor gasket | 1 |
| 43 | A188F-1-43 | Shroud | 1 | 93 | A188F-1-93 | Choke Comp | 1 |
| 44 | A188F-1-44 | Bolt M10x80 | 4 | 94 | A188F-1-94 | Carburetor | 1 |
| 45 | A188F-1-45 | Push Rod | 2 | 95 | A188F-1-95 | Carburetor connector | 1 |
| 46 | A188F-1-46 | Valve Lifter | 2 | 96 | A188F-1-96 | Carburetor gasket | 1 |
| 47 | A188F-1-47 | Oil Drain Plug | 2 | 97 | A188F-1-97 | Air Cleaner Stay | 1 |
| 48 | A188F-1-48 | Oil Drain Plug Washer | 2 | 98 | A188F-1-98 | Air Cleaner Case Comp | 1 |
| 49 | A188F-1-49 | Cylinder Head Gasket | 1 | 99 | A188F-1-99 | Air Cleaner Grid | 1 |
| 50 | A188F-1-50 | Locating Pin | 2 | 100 | A188F-1-100 | Air Cleaner Element | 1 |
| 51 | A188F-1-51 | Spark Plug | 1 | 101 | A188F-1-101 | Air Cleaner Cover Comp | 1 |
| | | | | 102 | A188F-1-102 | Cover screw | 1 |

PORTABILITY KIT INSTALLATION

The manufacturer recommends that you properly install the **Portability Kit** when using your generator. Installing the **Portability Kit** is not required for the GEN7000 to operate, but is included with the generator purchase.

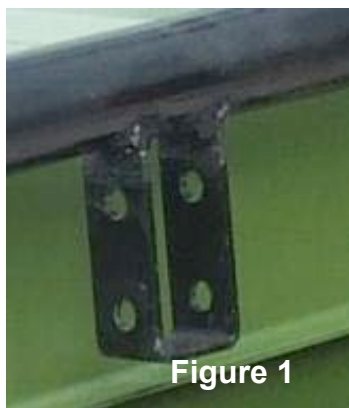

Figure 1

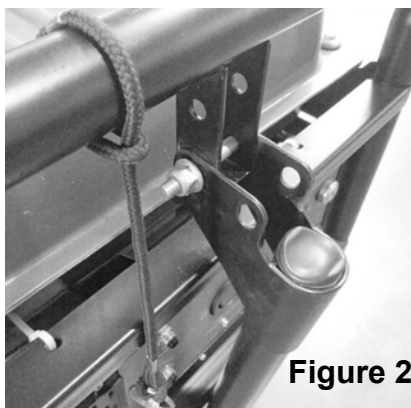

Figure 2

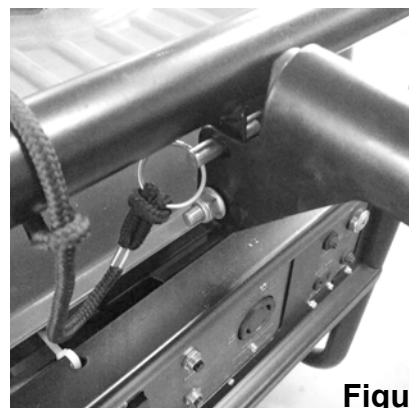

Figure 3

1. Locate the handle-mounting bracket on the generator frame. (Located on the top right side when looking at the control panel of the generator, Figure 1). Attached the handle by placing the handle around the outside of the handle-mounting bracket, and aligning the bottom set of holes. Insert a bolt (M8*50) through hole on the frame and the handle-mounting bracket, and secure with a nut (M8) and washer.

Insert the bolt pin (M8, which links with cable) into upper hole on the frame when the handle when moving the generator (Figure 2). To lower the handle remove the pin, lower the handle, and replace the bolt pin (Figure 3).



Figure 4



Figure 5

Install the wheel axle into frame (Figure 4), fix with Washer (B), Axle Bolt (A), Hex Nut (D) and Spacer (C). Tighten and secure both wheels. (Figure 5).

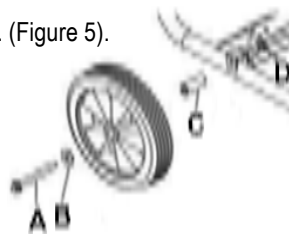

Figure 6



Figure 7

Install the stabilizing bar (Figure 6) by inserting the bolts (M8x20) through the feet on the stabilizing bar and the generator frame. Tighten the nut (M8) onto bolt. (Figure 7.)

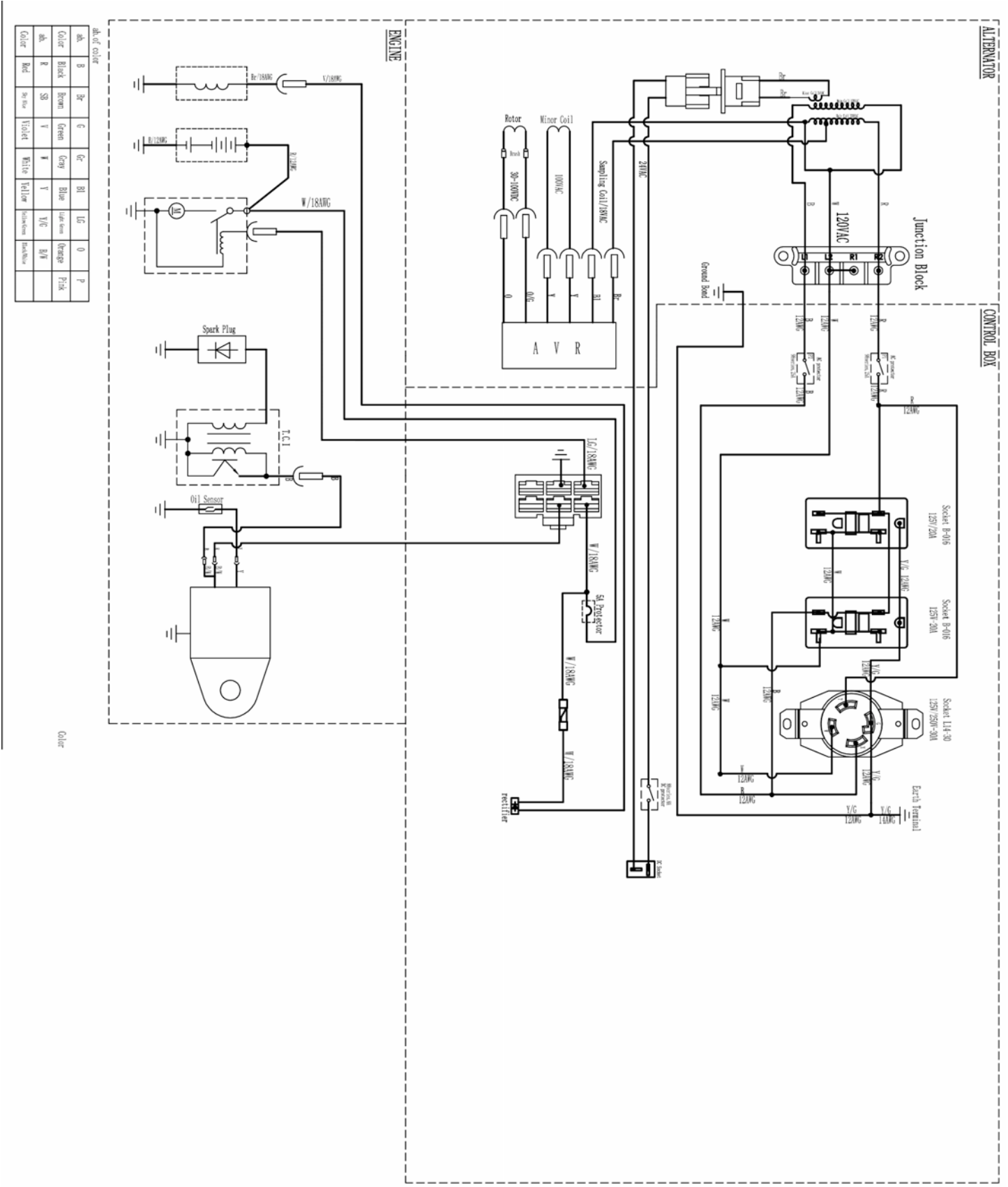

Figure 8

BATTERY TRAY INSTALLATION

A battery must be installed before the electric start feature can be used. Disconnect all electrical loads from this generator before installing/changing the battery. First, mount the battery case in the area located next to the starter. Insert the bolts (M6x12) through the frame and tighten the balance cover with the bolt (M6x12) after setting the battery in place. (Figure 8.) Install the battery by using the two cables (one red and the other black) that are attached to the engine. Attach the red/positive cable to the positive terminal on the battery. Attach the black/negative cable to the negative terminal on the battery. Slide the battery into the battery case. Use the enclosed rubber strap to secure the battery in place.

WIRING DIAGRAM



EMISSION CONTROL SYSTEM WARRANTY BUFFALO CORPORATION

Your Warranty Rights and Obligations

The California Air Resources Board, U.S. EPA and Buffalo Corp are pleased to explain the Emission Control System Warranty on your 2018 model year outdoor power equipment engine.

California

In California, new spark-ignited small off-stringent anti-smog standards.

Other States, U.S. Territories

In other areas of the United States, your engine must be designed, built and equipped to meet the U.S. EPA emission standards for spark-ignited engines at or below 19 kilowatts.

All of the United States

Buffalo Corp must warrant the emission control system on your power equipment engine for the periods of time listed below provided there has been no abuse, neglect or improper maintenance of your power equipment engine. Where a warrantable condition exists, Buffalo Corp will repair your power equipment engine at no cost to you including diagnosis, parts and labor.

Your emission control system may include parts such as: carburetors or fuel injection system, ignition system, catalytic converters, fuel tanks, valves, filters, clamps, connectors, and other associated components. Also, included may be hoses, belts, connectors, sensors, and other emission-related assemblies.

Manufacturer's Warranty Coverage

The emission control system is warranted for two years. If any emissions-related part on your engine is defective, the part will be repaired or replaced by Buffalo Corp.

Owner's Warranty Responsibility

As the power equipment engine owner, you are responsible for the performance of the required maintenance listed in your owner's manual. Buffalo Corp recommends that you retain all receipts covering maintenance on your power equipment engine, but Buffalo Corp cannot deny warranty solely for the lack of receipts or for your failure to ensure the performance of all scheduled maintenance. As the power equipment engine owner, you should however be aware that Buffalo Corp may deny your warranty coverage if your power equipment engine or a part has failed due to abuse, neglect, improper maintenance or unapproved modifications. You are responsible for presenting your power equipment engine to distribution center or service center authorized by Buffalo Corp as soon as the problem exists. The warranty repairs should be completed in a reasonable amount of time, not to exceed 30 days. If you have any questions regarding your warranty rights and responsibilities, you should contact a customer service representative at 1-866-460-9436 or email info@buffalotools.com

DEFECTS Warranty Coverage

Adopted by the Air Resources Board, Buffalo Corp warrants to the ultimate purchaser and each subsequent purchaser that the small off-road engine (SORE) (1) has been designed, built and equipped so as to conform with all applicable regulation; and (2) is free from defects in materials and workmanship that cause the failure of a warranted part to conform with those regulations as may be applicable to the terms and conditions stated below. (a) The warranty period begins on the date the engines is delivered to an ultimate purchaser or first placed into service. The warranty period is two years. (b) Subject to certain conditions and exclusions as stated below, the warranty on emissions related parts is as follows:

- (1) Any warranted part that is not scheduled for replacement as required maintenance in your Owner's Manual is warranted for the warranty period stated above. If the part fails during the period of warranty coverage, the part will be repaired or replaced by Buffalo Corp according to Subsection (4) below. Any such part repaired or replaced under warranty will be warranted for the remainder of the period.
- (2) Any warranty part that is scheduled only for regular inspection in your period stated above. Any such part repaired or replaced under warranty will be warranted for the remaining warranty period.
- (3) Any warranted part that is scheduled for replacement as required maintenance in your Owners Manual is warranted for the period of time before the first scheduled replacement date for that part. If the part fails before the first scheduled replacement, the part will be repaired or replaced by Buffalo Corp. according to the

Subject (4) below. Any such part repaired or replaced under warranty will be warranted for the remainder of the period prior to the first scheduled replacement point for the part.

(4) Repair or replacement of any warranted part under the warranty provisions herein must be performed at a warranty station at no charge to the owner.

(5) Notwithstanding the provisions herein, warranty services or repair will be provided at all of our distribution centers that are franchised to service the subject engines.

(6) The engine owner must not be charged for diagnostic labor that leads to the determination that a warranted part is in fact defective, provided that such diagnostic work is performed at a warranty station.

(7) Buffalo Corp. is liable for damages to other engine components proximately caused by a failure under warranty of any warranted part.

(8) Throughout the engine warranty period stated above, Buffalo Corp. will maintain a supply of warranted parts sufficient to meet the expected demand for such parts.

(9) Any replacement part may be used in the performance of any warranty maintenance or repairs and must be provided without charge to the owner. Such use will not reduce the warranty obligations of Buffalo Corp.

(10) Add-on or modified parts that are not exempted by the Air Resources Board may not be used. The use of any non-exempted add-on or modified parts by the ultimate purchaser will be grounds for disallowing a warranty claims. Buffalo Corp will not be liable to warrant failures of warranted parts caused by the use of a non-exempted add-on or modified part.

(11) The manufacturer issuing the warranty shall provide any documents that describe that manufacturer's warranty procedures or policies within five working days of request by the Air Resources Board.

EMISSION WARRANTY PARTS LIST

(1) Fuel Metering System:

(a) Gasoline carburetor assembly and its internal components

(b) Carburetor gaskets

(c) Fuel line

(d) Clamps

(e) Fuel tank

(f) Fuel line fittings

(g) pressure regulator (if equipped)

(h) Mixer assembly and its internal components (if equipped)

(2) Air induction system including: (a) Intake pipe/manifold

(b) Air cleaner

(3) Ignition system including: (a) Spark plug (b) Ignition coil

(4) Catalytic muffler assembly including: (a) Muffler gasket (b) Exhaust manifold (c) Catalytic converter if available

(5) Crankcase breather assembly including (a) Breather connection tube

(6) Fuel tank evaporative emissions control system including:

(a) Purge valves (b) Carbon canister (c) canister Mounting Brackets (d) Fuel Cap (e) Fuel Tank

(7) Miscellaneous items used in above systems including: (a) Switches (b) Hoses, belts connectors, and assemblies

(8) Air injection system (a) Pulse valve

201808