

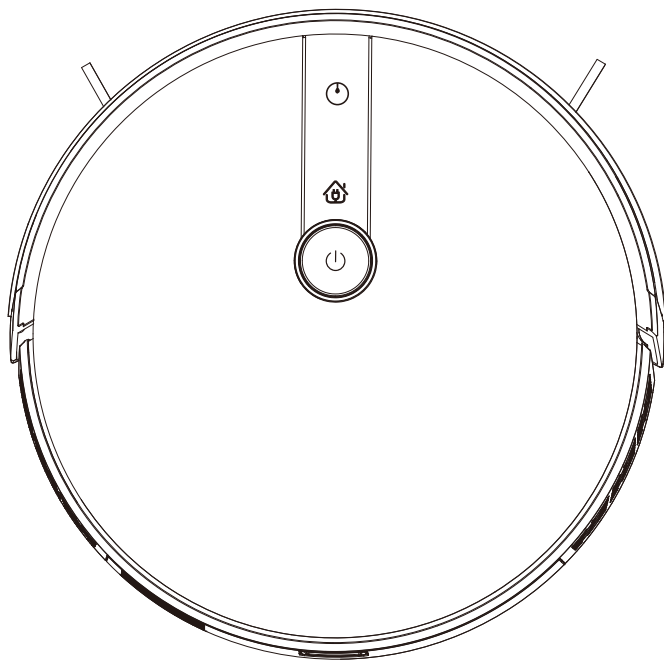

## Use & Care Guide



## ROBOT VACUUM CLEANER

MODEL NO. V12

[www.vacmaster.com](http://www.vacmaster.com)  
Cleva North America, Inc.  
Greenville, SC 29607  
(866) 384-8432  
Made in China

# TABLE OF CONTENTS

SECTION	PAGE
Important Safety Instructions.....	3
Warranty.....	6
Technical Data.....	6
Getting To Know Your Vacuum.....	7
Installation Instructions.....	11
Operating Instructions.....	17
Maintaining Your Vacuum.....	22
Troubleshooting.....	29

Thank you for purchasing this Vacmaster® vacuum cleaner. With it you are obtaining a high quality product that is engineered for optimal performance.

## FOR YOUR SAFETY

Read and understand this manual before use.

Keep this manual and your sales check (receipt) in a safe place for future reference.

# IMPORTANT SAFETY INSTRUCTIONS

When using an electrical appliance, basic precautions should always be followed, including the following:

## **READ ALL INSTRUCTIONS BEFORE USING THIS ROBOT VACUUM CLEANER.**

Failure to follow the warnings and instructions may result in electric shock, fire and/or serious injury.



### **WARNING - To reduce the risk of fire, electric shock, or injury:**

- Do not use outdoors or on wet surfaces.
- Do not allow to be used as a toy. Close attention is necessary when used by or near children, pets or plants.
- Use only as described in this manual. Use only manufacturer's recommended attachments.
- Do not use with damaged cord or plug. If appliance is not working as it should, has been dropped, damaged, left outdoors, or dropped into water, call (866) 384-8432 for assistance.
- Do not pull or carry by cord, use cord as a handle, close a door on cord, or pull cord around sharp edges or corners. Do not run appliance over cord. Keep cord away from heated surfaces.
- Do not unplug by pulling on cord. To unplug, grasp the plug, not the cord.
- Do not handle charger, including charger plug, and charger terminals with wet hands.
- Do not put any object into openings. Do not use with any opening blocked; keep free of dust, lint, hair, and anything that may reduce air flow.
- Keep hair, loose clothing, fingers, and all parts of body away from openings and moving parts.
- Do not use to pick up flammable or combustible liquids, such as gasoline, or use in areas where they may be present.
- Do not pick up anything that is burning or smoking, such as cigarettes, matches, or hot ashes.
- Do not use without dust bin.
- Turn off the appliance before making any adjustments, changing accessories, or storing appliance. Such preventive safety measures reduce the risk of starting the appliance accidentally.

- Use only the charging dock specially equipped by the manufacturer.
- Under abusive conditions, liquid may be ejected from the battery; avoid contact. If contact accidentally occurs, flush with water. If liquid contacts eyes, additionally seek medical help. Liquid ejected from the battery may cause irritation or burns.
- Do not use the appliance that is damaged or modified. Damaged or modified batteries may exhibit unpredictable behavior resulting in fire, explosion or risk of injury.
- Do not expose the appliance to fire or excessive temperature. Exposure to fire or temperature above 130°C (265°F) may cause explosion.
- It is recommended to operate appliance at room temperature between 39.2°F (4°C) and 104°F (40°C).
- It is recommended to store the appliance between 32°F (0°C) and 104°F (40°C).
- It is recommended to apply the boundary strips (not included) to block off areas on top stair where the appliance may fall.
- Follow all charging instructions and do not charge the appliance outside of the temperature range specified in the instructions. Charging improperly or at temperatures outside of the specified range may damage the battery and increase the risk of fire.
- Have servicing performed by a qualified repair person using only identical replacement parts. This will ensure that the safety of the appliance is maintained.
- Do not modify or attempt to repair the appliance or the battery pack except as indicated in the instructions for use and care.
- Place the cords from other appliances out of the area to be cleaned.
- Do not operate the appliance in a room where an infant or child is sleeping.
- Do not operate the appliance in an area where there are lit candles, fragile objects or a working heater on the floor to be cleaned. The appliance may accidentally hit or bump into the heat resources resulting in fire or risk of injury.
- Do not allow children to sit on the appliance.

 **WARNING:** Any changes or modifications to this unit not expressly approved by the party responsible for compliance could void the user's authority to operate the equipment.

**NOTE:** This equipment has been tested and found to comply with the limits for a Class B digital device, pursuant to Part 15 of the FCC Rules. These limits are designed to provide reasonable protection against harmful interference in a residential installation. This equipment generates, uses and can radiate radio frequency energy and, if not installed and used in accordance with the instructions, may cause harmful interference to radio communications. However, there is no guarantee that interference will not occur in a particular installation. If this equipment does cause harmful interference to radio or television reception, which can be determined by turning the equipment off and on, the user is encouraged to try to correct the interference by one or more of the following measures:

- Reorient or relocate the receiving antenna.
- Increase the separation between the equipment and receiver.
- Connect the equipment into an outlet on a circuit different from that to which the receiver is connected.
- Consult the dealer or an experienced radio/TV technician for help.

## **Product Disposal**

This product contains an internal Lithium-ion battery pack formulated from environmentally sensitive materials. This product must be disposed of properly with due care for the environment.

Do not dispose of product with household garbage. Consult your local waste authority for information regarding available recycling or disposal options.

## **SAVE THESE INSTRUCTIONS**

Household use only.

# WARRANTY

FOR ONE YEAR from the date of sale, this product is warranted against defects in material or workmanship when it is assembled, operated and maintained according to all supplied instructions.

WITH PROOF OF SALE, a defective appliance will be replaced free of charge. For warranty coverage details to obtain free replacement, visit the web page: [www.vacmaster.com](http://www.vacmaster.com) or call (866) 384-8432.

- This warranty does not cover filters, which are expendable parts that can wear out from normal use within the warranty period.
- This warranty is void if this product is ever used for other than private household purposes.
- This warranty gives you specific legal rights, and you may also have other rights which vary from state to state.

# TECHNICAL DATA

## **Robot Vacuum Cleaner**

Rated Voltage: 14.4VDC

Rated Power: 28W

Model: V12

## **Battery Charger**

Model: GQ12-190060-AU

Input: 100- 240VAC, 50/60Hz, 0.4A Max

Output: 19VDC, 0.6A

## **Battery**

Type: 14.4V rechargeable Lithium-Ion 2500mAh

# GETTING TO KNOW YOUR VACUUM

## Included in the Box:

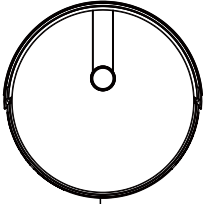

Robot Vacuum Cleaner

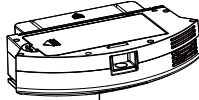

Dust Bin

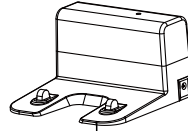

Charging Dock

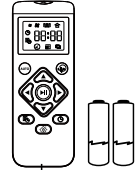

Remote Control  
with 2 AAA Batteries

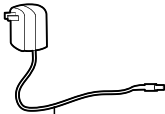

Charging Adapter

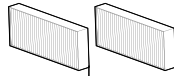

High Efficiency  
Filter (x2)



Cleaning Tool

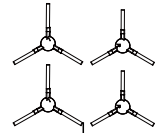

Side Brush (x2 sets)

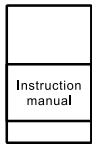

Use & Care Guide



Quick Start Guide

# About Your Robot Vacuum

## Front Robot

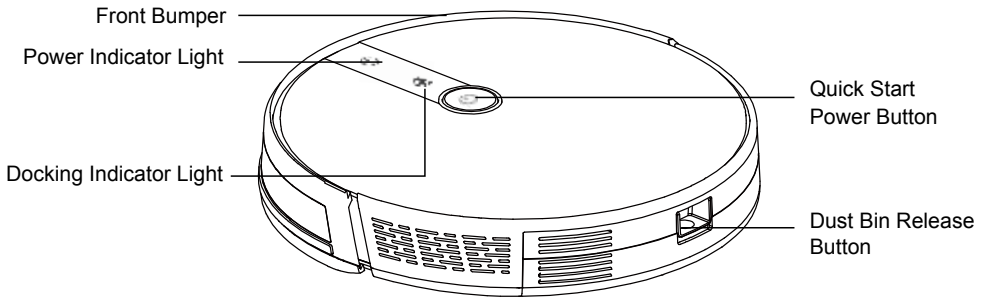

## Back Robot

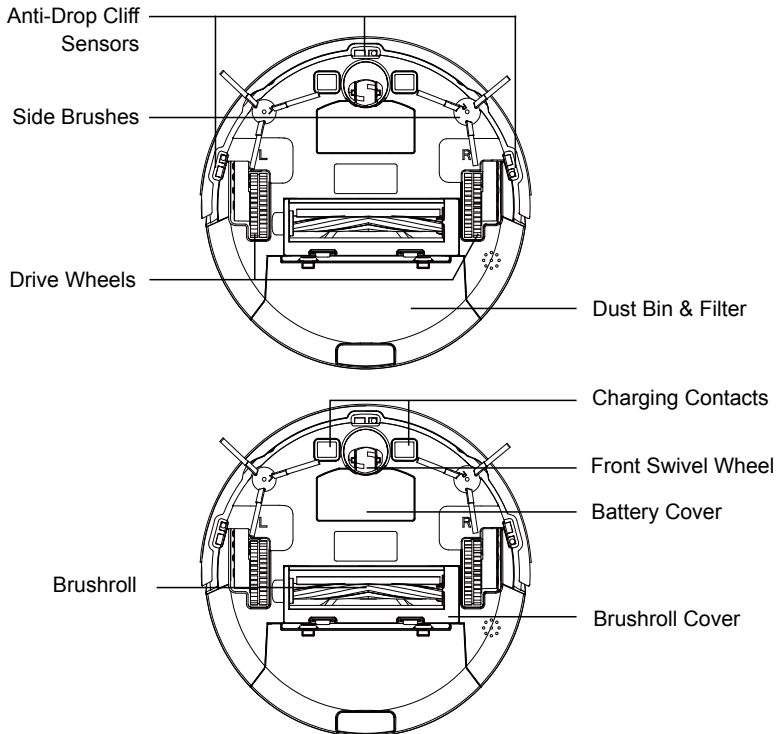



## Dust Bin & Filter

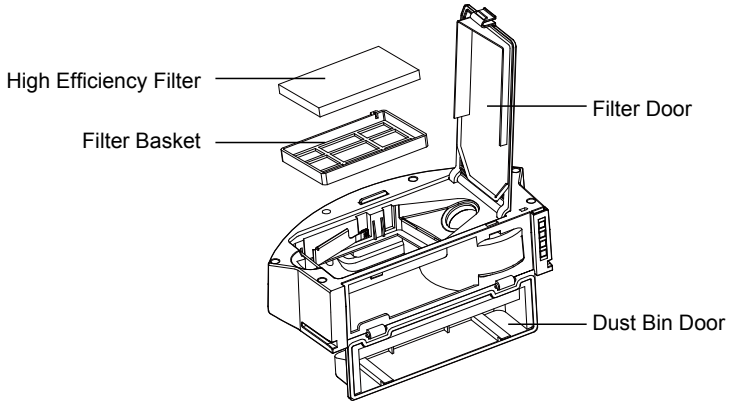

## Charging Dock

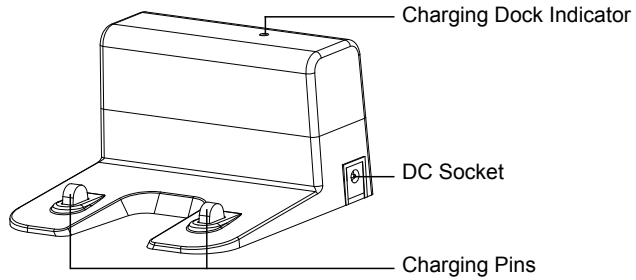

## Remote Control

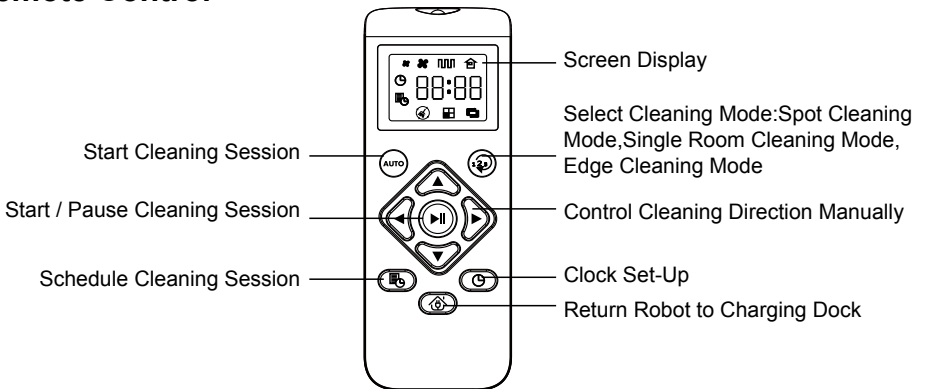

**NOTE:** Install 2 AAA batteries before using the remote control for the first time. Make sure the positive and negative ends are facing the correct polarity direction as marked in the battery compartment.

## REPLACEMENT PARTS

Item	Part No.
High Efficiency Filter	611002101
Filter Basket	611002102
Side Brushes (L/R)	611002106 / 611002107
Remote Control	611002108
Cleaning Tool	611002103
Brushroll	611002105
Brushroll Cover	611002109
Front Swivel Wheel	611002110
Charging Dock	611002119
Charging Adapter	611002112
Battery	611002120
Dust Bin	611002111
Boundary Strip (not included, but available on <a href="http://Vacmaster.com">Vacmaster.com</a> )	611002130

Available online at [www.vacmaster.com](http://www.vacmaster.com) or call (866) 384-8432.

# INSTALLATION INSTRUCTIONS

## Important Tips Before Use

1. Remove power cords and other obstructions to prevent your robot from getting entangled or trapped. You can use cable ties to organize your wires and power cords.

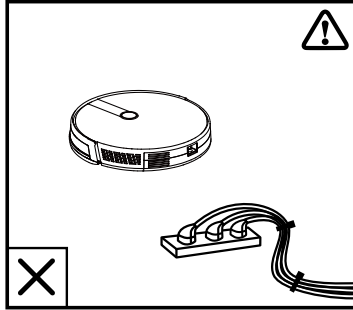

2. Fold tasseled edges of area rugs underneath to prevent these from getting entangled or trapped. Your robot may have trouble with dark colored rugs. Block off areas as necessary.

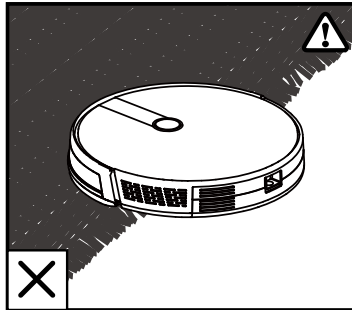

3. To prevent your robot from becoming stuck, use furniture risers for spaces lower than 3.15 inches (80mm). If necessary, place a physical barrier to block off the problem areas.

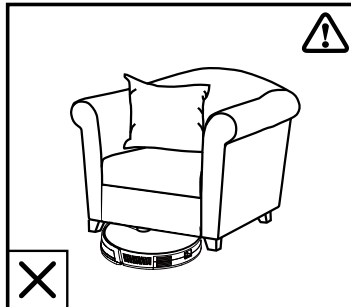

4. Prevent your robot from vacuuming wet areas as this could damage your vacuum.

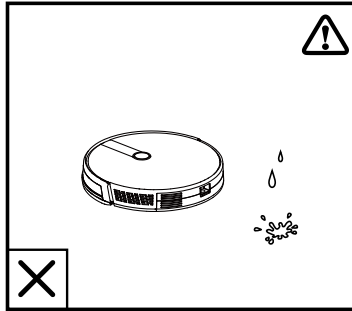

5. Remove any objects less than 0.6 inches (15mm) in height as robot may climb over.

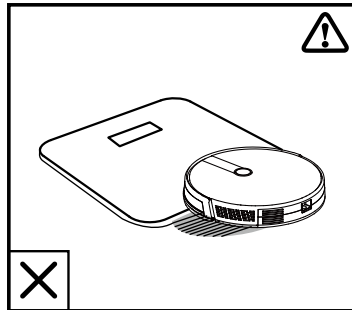

6. Anti-drop cliff sensors prevent the robot from tumbling down stairs and steep drops. Your robot may have trouble if the sensors are dirty or if used on reflective / dark colored floors. If necessary, place a physical barrier or boundary strip (sold separately) to block off.

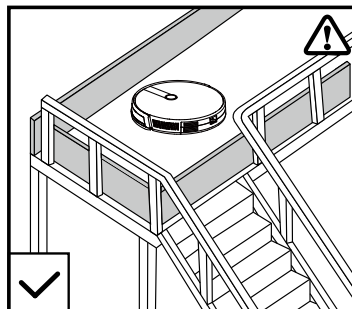

**NOTE:** Place physical barriers or boundary strips (sold separately) in front of fireplaces and areas that you do not want the robot to enter. To order boundary strips, please visit [www.vacmaster.com](http://www.vacmaster.com) or call us at (866) 384-8432.

## 7. Use Boundary Strips (Sold Separately)

The boundary strips allow you to keep your robot from entering an area or picking up an item that the robot should not clean. The robot will recognize the boundary strips and will not cross into the blocked-off area. See page 27 for installation instructions.

## Installation Instructions

### 1. Remove Protection

Before using robot, remove the protective covers on the robot and charging dock.

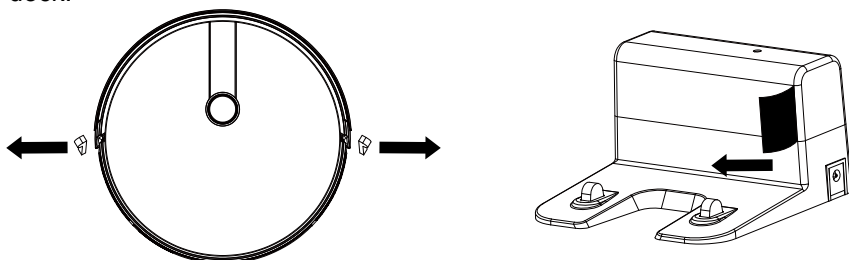

### 2. Set-Up the Charging Dock

Your charging dock should be on a level, hard surface against the wall in a central location that can easily be accessed by your robot vacuum. Remove any objects that are closer than 5ft (1.5m) from the front and 3ft (1m) from either side of the dock.

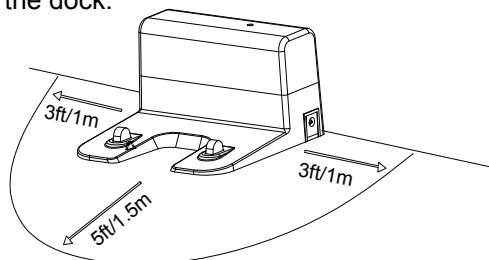

### 3. Connect the Charging Adapter

Plug the charging adapter into a wall outlet and plug the connector into the socket on the side of the charging dock. When the charging dock connects to a power supply, the LED indicator on the charging dock will flash. The charging dock must be plugged in at all times for the robot to find the dock.

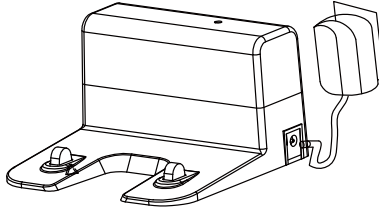

### 4. Install Side Brushes

Your Vacmaster<sup>®</sup> robot comes with two side brushes that need to be installed on the bottom of the vacuum. Each side brush is installed on a specific side of the robot and indicated with an L or R on the front of the side brush. Match up the letter on the side brush with the letter on the back of the robot. To install, simply push side brush onto the square peg.

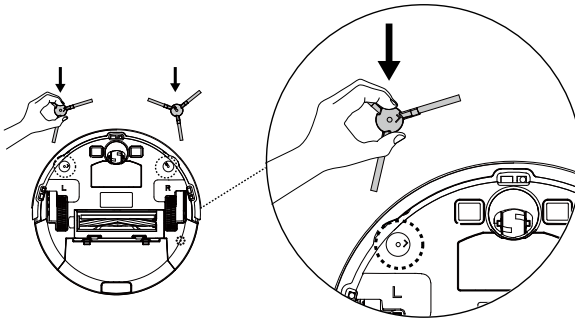

### 5. Charge the Robot

Your Vacmaster<sup>®</sup> robot has a pre-installed rechargeable battery, which must be charged before using. There are two options for charging, which include manually placing robot on the charging dock or by pressing the  button on the remote control.

### Option 1 – Manually Connect Robot to Charging Dock

Align the charging pins on the bottom of the robot with the charging pins on the dock. When the robot is successfully connected to the charging dock, an audible tone will activate. The docking indicator light on the robot will flash to indicate the robot is charging. Once charging is completed, the indicator light will illuminate steadily. Charging time is approximately 5 hours.

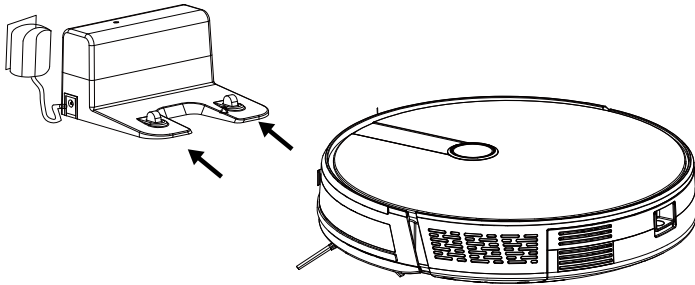

**!** **CAUTION:** When manually charging your robot, keep the robot 1cm away from the back of the charging dock. Make sure the charging pins of the robot are well connected to the charging pins of the charging dock. Ensure that there is nothing obstructing the connections which may prevent charging.

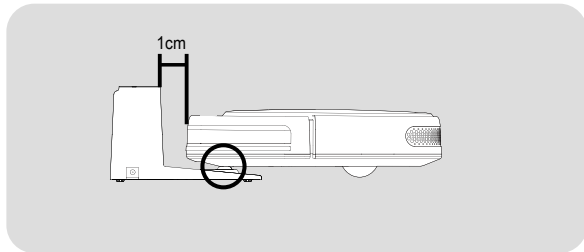

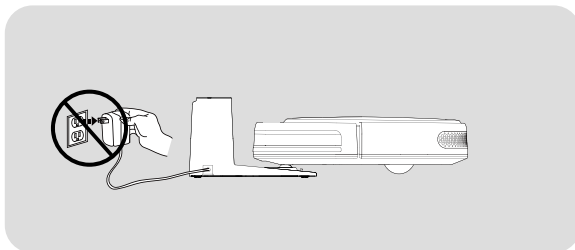

**!** **CAUTION:** In order to ensure the battery life of the robot, do not remove the charging adapter before the robot is fully charged.



## Option 2 – Remote Control Charging

Press  on the remote control to return the robot to the charging dock. During the cleaning process, the robot can sense when battery power is low and automatically converts to recharging mode to start its return to the charging dock.

 **CAUTION:** Use only original adapter for charging to avoid damages to vacuum cleaner.

 **CAUTION:** To optimize the battery longevity, charge the vacuum cleaner for at least 5 hours before using for the first time. Never charge the batteries in temperatures above 104°F (40°C) or below 39.2°F (4°C). It is normal for the charger to become warm when charging. It is recommended to store the robot between 32°F (0°C) and 104°F (40°C).

**NOTE:** To preserve the battery's longevity, recharge at least once every 3 months.





# OPERATING INSTRUCTIONS



 **CAUTION:** Operate robot at room temperature between 39.2°F (4°C) and 104°F (40°C) in order to ensure its safety and normal function. Make sure the dust bin is installed before use.

## General Operating Instructions

### • Turn On Robot

Wake up robot by pressing  on the robot. The power indicator light will illuminate. To start the robot vacuum, either press the  button again, or press the  button on the remote control.

### • Pause or Stop a Cleaning Session

Press  on the robot or  on the remote control to pause a cleaning session. If you want the robot to return to the charging dock, press  on the remote control.

### • Power Off Robot

Pause the robot and press  on the robot for three seconds to turn off the robot.



**NOTE:** If the robot stops working for more than ten minutes, it automatically enters the sleep mode (all the lights on the robot will turn off). Press  on the robot or any key on the remote control to wake up robot.

**NOTE:** The robot will return to the charging dock automatically when the battery level becomes low or when the robot finishes cleaning.

## Select a Cleaning Mode (If Desired)

Your advanced robot has the capability of operating in 5 different modes to satisfy all your cleaning needs.

### 1. Smart Cleaning Mode

Press  on the robot or  on the remote control to start cleaning in Smart Cleaning Mode.

Press  again on the remote control to adjust the suction power level among 3 suction modes: Standard Mode, Max Power Mode and Quiet Mode. Max Power Mode is ideal for cleaning thicker carpets and hard-to-sweep messes.

**NOTE:** The suction control feature only works in Smart Cleaning Mode.

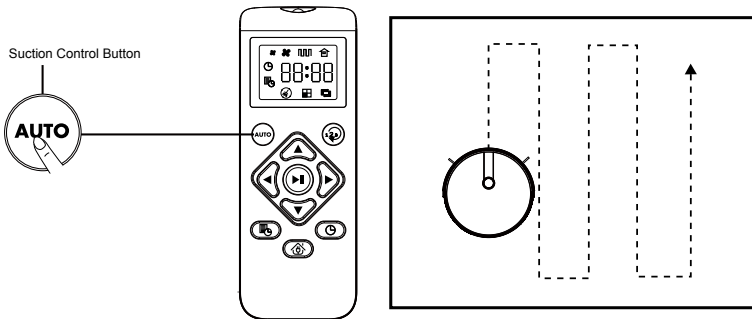

## 2. Spot Cleaning Mode

Press (1) on the robot or (AUTO) on the remote control to start cleaning in Smart Cleaning Mode. Then press the (+2) button one time on the remote control to start the robot in Spot Cleaning Mode. The Spot Cleaning icon will display on the remote control screen.

Spot cleaning is designed to clean a specific area with a spiral movement in a radius of 3ft (1m) and should be used to clean a concentrated area of dust or debris.

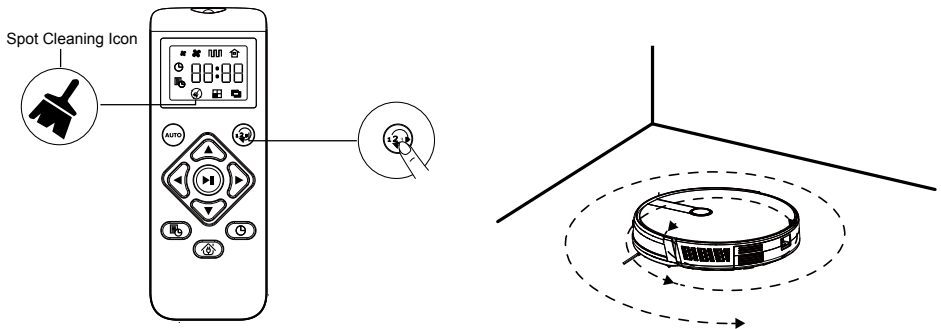

## 3. Single Room Cleaning Mode



Press (1) on the robot or (AUTO) on the remote control to start cleaning in Smart Cleaning Mode. Then press the (+2) button twice on the remote control to start the robot in Single Room Cleaning Mode. The Room Cleaning icon will display on the remote control screen. The robot will operate in Max Power Mode and also vacuum the edges before finishing the cleaning session.

Make sure to confine the robot to the room by closing the door or creating a physical barrier. The robot will automatically return to the start location once finished.

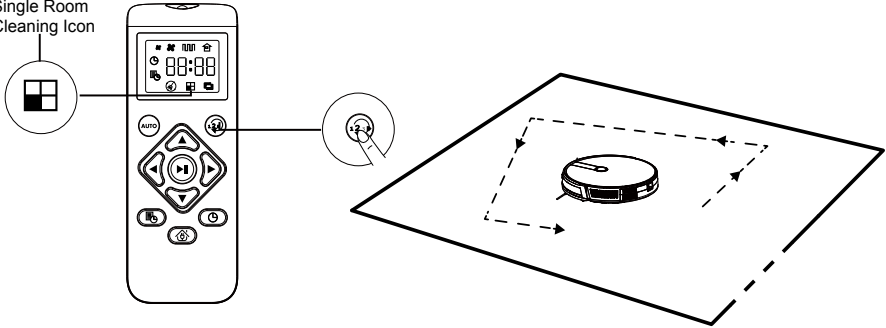
Single Room  
Cleaning Icon



#### 4. Edge Cleaning Mode

Press  on the robot or  on the remote control to start cleaning in Smart Cleaning Mode. Then press the  button three times on the remote control to start the robot in Edge Cleaning Mode. The Edge Cleaning icon will display on the remote control screen.

This intelligent robot automatically reduces its moving speed once it detects a wall and then cleans along the wall to ensure the edge is cleaned thoroughly. The robot will return to the charging dock once finished.

Edge Cleaning Icon

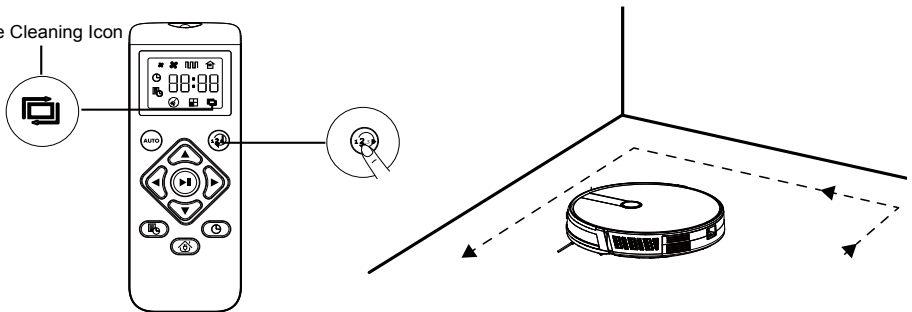

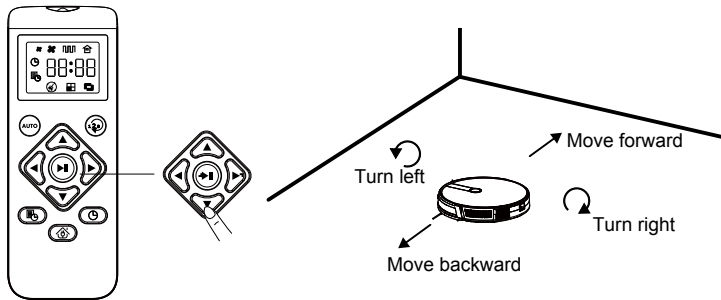

#### 5. Manual Cleaning

You can direct the robot to clean a particular area by using the directional buttons on the remote control. Start the robot in Smart Cleaning Mode and then use the directional arrows on the remote control to adjust the cleaning path of the vacuum cleaner as necessary.



## Set Up Clock

1. Insert the included 2 AAA batteries into the remote control.
2. Press  on the remote control. The time will blink on the display screen.
3. Use the directional arrows  on the remote to set the “hour” and “minute”.

The remote uses a 24 hour clock. Reference the chart below when setting the clock and scheduling cleaning sessions.

4. Press  to save the clock setting.

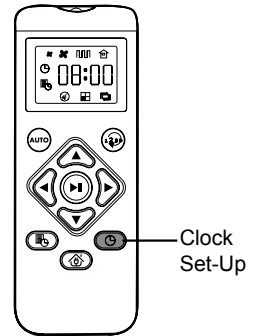





12-Hour Clock	24-Hour Clock	12-Hour Clock	24-Hour Clock
1:00 AM	01:00	1:00 PM	13:00
2:00 AM	02:00	2:00 PM	14:00
3:00 AM	03:00	3:00 PM	15:00
4:00 AM	04:00	4:00 PM	16:00
5:00 AM	05:00	5:00 PM	17:00
6:00 AM	06:00	6:00 PM	18:00
7:00 AM	07:00	7:00 PM	19:00
8:00 AM	08:00	8:00 PM	20:00
9:00 AM	09:00	9:00 PM	21:00
10:00 AM	10:00	10:00 PM	22:00
11:00 AM	11:00	11:00 PM	23:00
12:00 PM	12:00	12:00 AM	00:00

## Schedule a Cleaning Session

You can schedule the robot to start cleaning at a specified time.

**NOTE:** The robot will automatically turn on once you connect the robot to the charging dock.

1. Within a couple feet of the robot and with no obstacles between you and the robot, point the remote control directly at the robot and press  on the remote control. The time will blink on the display screen..
2. Use the directional arrows  on the remote to set the “hour” and “minute”. The remote uses a 24 hour clock. Reference the clock chart to schedule cleaning sessions at the appropriate time.
  - 1) For example, to schedule a cleaning for 5:30 pm, set the remote for 17:30.
  - 2) Press  to save the setting
3. To cancel a previously scheduled cleaning, press  for 3 seconds.

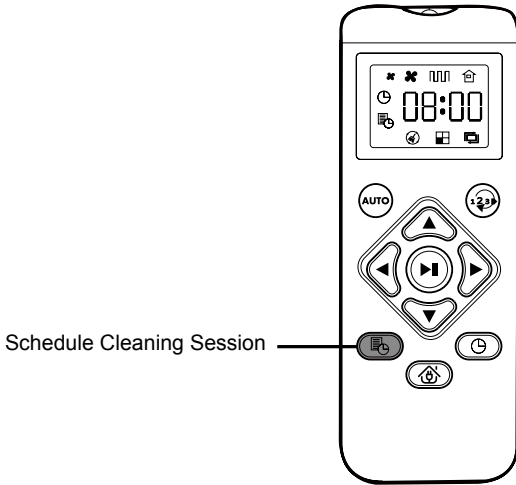

# MAINTAINING YOUR VACUUM

## Regular Maintenance

For optimal performance, follow the instructions below to clean and maintain the robot. Reference the table below as a guide for how often you should be cleaning and replacing parts of your robot.

**NOTE:** The cleaning and/or replacement frequency will depend on your usage of the robot.

Robot Part	Cleaning Frequency	Replacement Frequency
High Efficiency Filter	Once every week	Every 2 months
Filter Basket	Once every week	Every 2 months
Brushroll	Once every week	Every 6-12 months
Side Brushes	Once every month	Every 3-6 months (or when visibly worn)
Brushroll Cover	Once every month	Every 3-6 months (or when the silicone rubber strip on the cover becomes visibly worn)
Anti-Drop Cliff Sensors	Once every month	N/A
Charging Dock Pins	Once every month	N/A
Front Swivel Wheel	Once every month	N/A

## Emptying the Dust Bin and Cleaning Filters

**⚠ CAUTION: Do not use the robot when the dust bin is full.**

1. Press the Dust Bin Release Button and slide out the dust bin from robot.

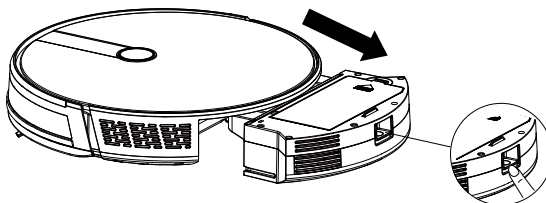

2. Holding the dust bin upright, snap the back panel open and empty contents into receptacle. To re-install, snap panel back into dust bin.

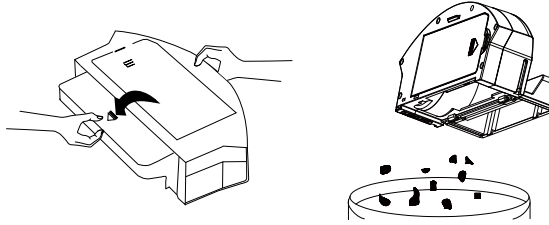

3. Open the high efficiency filter cover and take out the filter and filter basket.

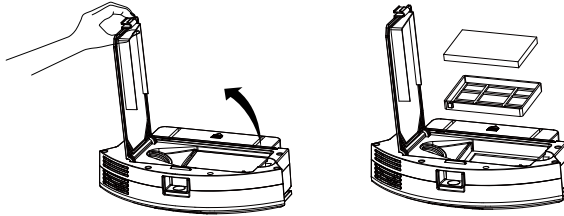

4. Clean the dust bin and filters with the included cleaning tool.

**NOTE:** Do not wash the high efficiency filter. Use the included cleaning tool to remove debris from filter.

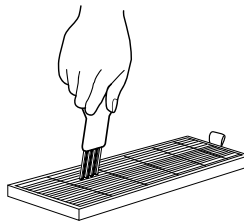

5. Your filter basket is washable. Clean with water only and leave to air dry before re-installing in robot.

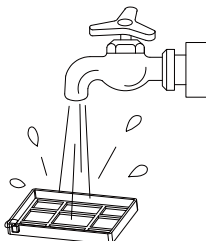

6. With the filter removed, close filter door and clean out dust bin with a dishcloth. Do not allow water into the vent.

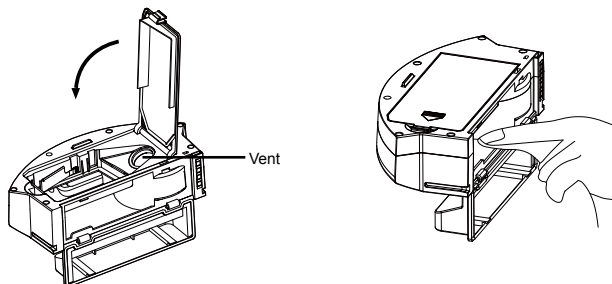

**NOTE:** Do not wash the dust bin.

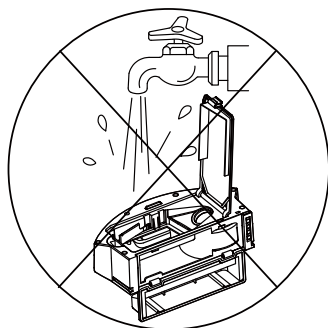

7. Dry the dust bin, filter basket and filter completely. Keep the inside of the robot dry to ensure the life of the vacuum.

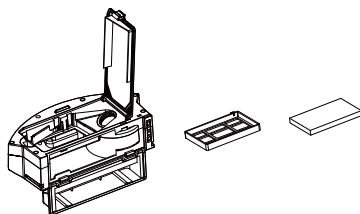

8. Re-install the high efficiency filter into the filter basket and place into dust bin.

**!** **CAUTION:** Before installing the filters, ensure that the filter basket and the high efficiency filter are dry.



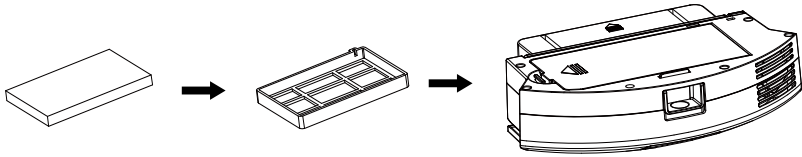

9. Close the dust bin door and slide the dust bin into the robot.

## Cleaning the Brushroll

1. Press the two release tabs to unlock the brushroll cover.

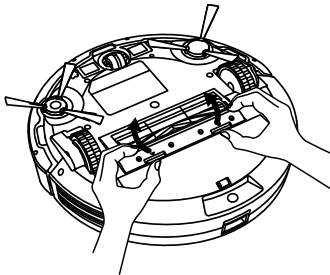

2. Lift the brushroll to remove.

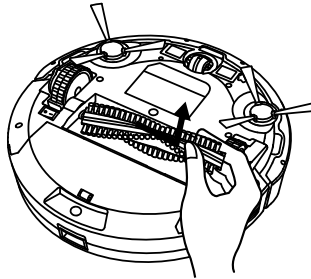

3. Clean the brushroll with the provided cleaning tool. Make sure that you remove any hair wrapped around the edges of the brushroll.

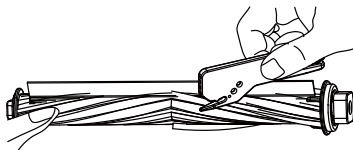

4. Reinstall the brushroll by inserting the fixed protruding end first and then clicking into place.

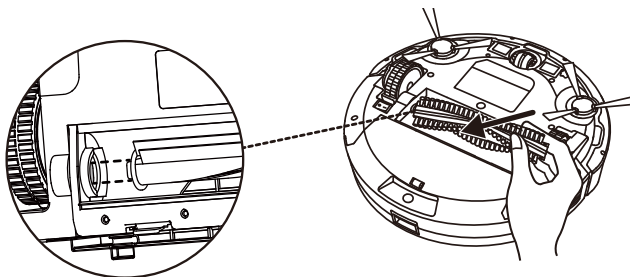

5. Align cover into place on the robot and then press down until you hear a 'click' indicating the cover is securely installed.

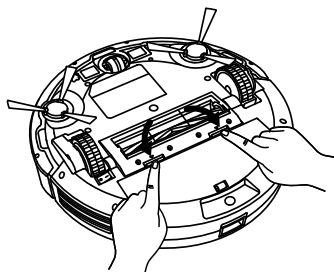

## Cleaning and Replacing the Side Brushes

1. Remove the side brushes by pulling upwards.

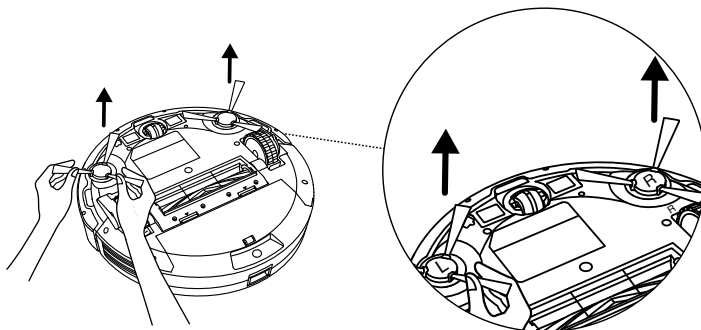

2. Carefully unwind and pull off any hair or string that is wrapped between the main unit and the side brushes.
3. Use a cloth dampened with warm water to remove dust from the brushes.

**NOTE:** Only use the side brushes when completely dry.

4. Re-install the side brushes according to the left (L) and right (R) markings.

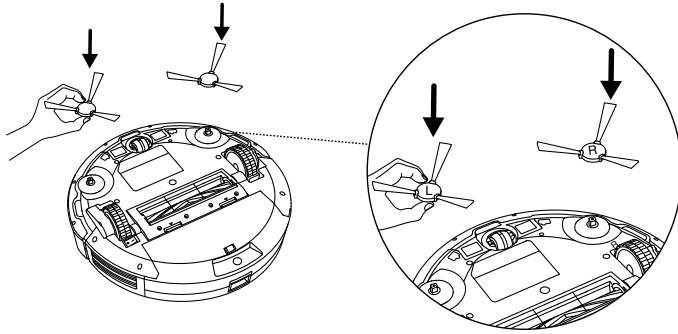

## Cleaning the Sensors and Charging Pins

To maintain the best performance, clean the anti-drop cliff sensors and charging pins regularly.

Dust off the anti-drop cliff sensors and charging contact pins using a cloth or the provided cleaning brush.

**CAUTION:** Use dry dishcloth for cleaning, and do not use wet dishcloth to prevent damage caused by water.

1. Clean the charging dock pins.

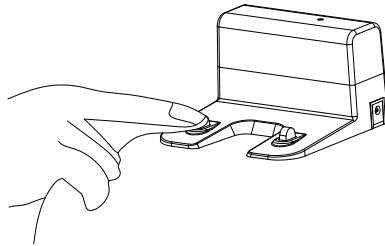

2. Clean the three anti-drop cliff sensors and drive wheels.

Anti-drop Cliff Sensors

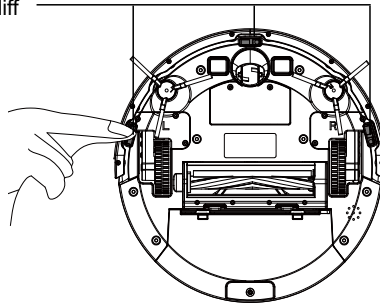

3. Hair and dust can become tangled in the front swivel wheel. Remove the swivel wheel from the unit and clean.

**NOTE:** Reinstall the wheel onto the robot after cleaning and ensure it is fully and securely locked into place.

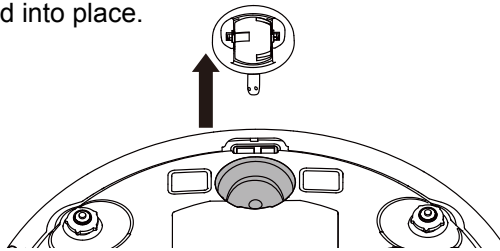

## Boundary Strip Installation Instructions

1. Identify the area or item where you want to install the boundary strips.
2. If necessary, use scissors to cut the boundary strip to a shorter length. Be sure to correctly measure the length before cutting. Do not try and reduce the width of the boundary strips by cutting.

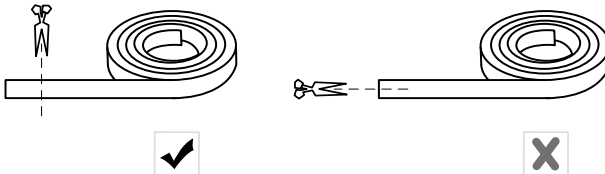

3. Apply adhesive tape to lay the boundary strip flat on the floor. Make sure the strip is placed flat on the floor or under a rug.

**NOTE:** Make sure the boundary strip is placed on the same surface plane the robot is used on. Be careful not to damage the floor when using adhesive tape. It is not recommended for use on carpets. Keep the boundary strip away from objects that emit excessive heat.

# TROUBLESHOOTING

Should you have any problem(s) with your robot vacuum cleaner, review the table below for solutions to minor performance issues. If the issues cannot be solved, **please try to turn off the robot vacuum cleaner and restart.**

PROBLEM	POSSIBLE CAUSE	SOLUTION
Robot vacuum cleaner will not power on.	The robot vacuum cleaner is powered off.	Press the power button to turn the robot vacuum cleaner on.
	The battery may be depleted.	Charge the battery as instructed on page 14.
	The batteries in the remote control may be depleted.	Replace the batteries (2 AAA) in the remote control.
The remote control does not work.	The batteries in the remote control are depleted.	Replace the batteries (2 AAA) in the remote control.
	The robot vacuum cleaner is powered off.	Press the quick start power button to turn the robot vacuum cleaner on.
	There is obstacle between the robot and remote control.	Ensure the remote control is operated within direct line of sight to the vacuum.
Robot vacuum cleaner does not work.	The anti-drop cliff sensors are dirty.	Clean the anti-drop cliff sensors.

Robot vacuum cleaner stops working suddenly.	The side brushes are jammed.	Remove any entangled objects or string/hair wrapped around brushes.
	The wheels are jammed.	Remove any entangled objects and clean wheel housing by rotating wheel while dusting.
	The battery may be depleted.	Charge the battery as instructed on page 14.
	The brushroll is jammed or is installed incorrectly.	Remove the obstruction and reinstall the brushroll. Follow instructions on page 24.
	The robot vacuum cleaner is stuck in an area.	Free the robot vacuum cleaner and remove the obstacles. Restart the vacuum cleaner.
Robot vacuum cleaner reverses backwards irregularly.	The front bumper sensor is jammed .	Remove any debris that may have become trapped behind the front bumper sensor.
Robot vacuum cleaner does not clean automatically at scheduled time.	The robot vacuum cleaner is powered off.	Press the power button to turn the robot vacuum cleaner on.
	The scheduled time is set incorrectly.	Reset the scheduled time as instructed on page 20.
	The battery may be depleted.	Charge the battery as instructed on page 14.
	The scheduled time has been reset.	All settings may be erased when robot vacuum cleaner is turned off or when the battery power is exhausted. You may need to reset the time and reschedule the cleaning time.

Suction power is weak.	Dust bin is full.	Empty dust bin.
	Filter needs cleaning.	Follow filter cleaning instructions on page 22.
	Filter needs to be replaced.	Purchase online at <a href="http://www.vacmaster.com">www.vacmaster.com</a> or call (866) 384-8432.
	The battery may be depleted.	Charge the battery as instructed on page 14.
	Dust bin is not installed correctly.	Check dust bin for correct installation and ensure it is snapped firmly in place.
	Robot sets on Quiet Mode.	Press the  button on the remote control to switch to Max Power Mode.
	Filters are missing or installed incorrectly.	Check filters for correct installation.
Robot vacuum cleaner cannot be charged.	The charging pins on the robot are not aligning with the pins on the charging dock.	Make sure charging pins are cleaned and in direct contact with each other.
	The charging dock or charging adapter is damaged.	Purchase online at <a href="http://www.vacmaster.com">www.vacmaster.com</a> or call (866) 384-8432.
	Debris accumulated on the charging pins.	Clean charging pins.
Robot vacuum cleaner cannot return to the charging dock.	There are objects near the charging dock.	Remove any objects that are closer than 5ft (1.5m) from the front and 3ft (1m) from either side of the dock.
	The robot is stuck in an area or tangled with an object.	Pick up the robot and remove any obstructions. Manually re-connect robot to charging dock.

## Error Tones

**NOTE:** When the robot requires assistance, you will hear an alert sound and/or beeps.

### Flashing Red Power Indicator Light

ERROR TONE	CAUSE	SOLUTION
Alert Sound Only	Robot wheels have left the ground.	Return the robot to the ground ensuring the wheels are in contact with the ground.
	Dust bin is not installed or installed incorrectly.	Follow installation instructions on page 21.
Alert Sound with 3 Beeps	The side brushes are jammed.	Pick up the robot and remove any obstructions such as hair or string.
	The wheels are jammed.	Pick up the robot and remove any obstructions such as hair or string.
	The brushroll is jammed.	Pick up the robot and remove any obstructions such as hair or string. Reinstall the brushroll with instructions on page 24.
	The front bumper is jammed.	Remove any obstructions such as hair or string.
Turn off the robot by holding down the power button for 3 seconds. Restart the robot by pressing the power button twice. If problem persists, call us at (866) 384-8432 for further assistance.		

### Solid Yellow Docking Indicator Light

ERROR TONE	CAUSE	SOLUTION
Alert Sound Only	Battery level is low.	Charge the robot. Follow instructions on page 14.

For further questions, please visit us at [www.vacmaster.com](http://www.vacmaster.com) or call our support team at (866) 384-8432.