



Item # 662 701  
Model #131-012-42CT

## USE AND CARE GUIDE

---

### EDINGTON 42 IN. CAST TOP COFFEE TABLE

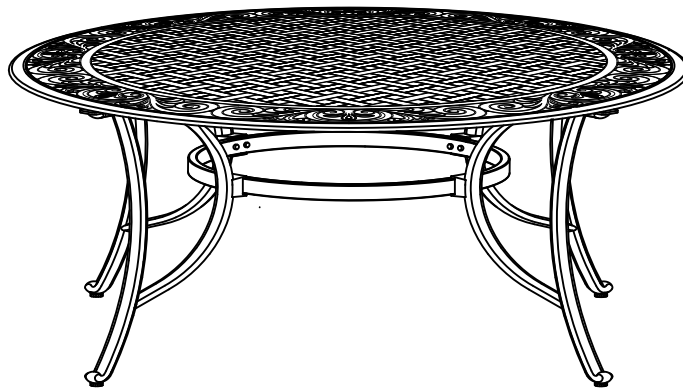

Questions, problems, missing parts? Before returning to the store,  
call Hampton Bay Customer Service  
8.00 a.m. - 6.00 p.m., EST, Monday - Friday

**1-855-HD-HAMPTON**

**HAMPTONBAY.COM**

---

#### **THANK YOU**

*We appreciate the trust and confidence you have placed in Hampton Bay through the purchase of this table. We strive to continually create quality products designed to enhance your home. Visit us online to see our full line of products available for your home improvement needs. Thank you for choosing Hampton Bay!*

# Table of Contents

Table of Contents.....	2	Pre-Assembly .....	3
Safety Information.....	2	Planning Assembly .....	3
Warranty.....	2	Hardware Included.....	3
5 Year Frame Limited Warranty.....	2	Package Contents .....	4
What Is Covered .....	2	Assembly .....	5
What Is Not Covered .....	2		
Care Instructions .....	2		

# Safety Information



**DANGER:** Please keep children out of the assembly area during assembly.



**WARNING:** Do not stand or sit on the table. Do not put heavy objects on the table.



**CAUTION:** Use the table on flat ground only.

# Warranty

## 5 YEAR FRAME LIMITED WARRANTY

### WHAT IS COVERED

We warrant the frame to be free of manufacturing defects to the original purchaser for five years.

### WHAT IS NOT COVERED

It remains the customer's responsibility for freight and packaging charges to and from our service center. This warranty does not cover commercial use, hardware, acts of nature, fire, freezing and abusive use. In addition, purchased parts are not covered under this warranty. We reserve the right to make substitutions with similar merchandise, if the model in question is no longer in production.

# Care Instructions

Before using, wipe with a clean, dry cloth. Do not use bleach or solvents. Treat the frame with liquid wax for maximum protection against UV light and salty, damp air. When not in use, store the furniture in a cool, dry place.

You may contact our customer service department with any questions by phone at 1-855-HD-HAMPTON or visit [www.hamptonbay.com](http://www.hamptonbay.com).

# Pre-Assembly

## PLANNING ASSEMBLY

It will take two people about 10 minutes to complete the assembly process.

## HARDWARE INCLUDED



**NOTE:** Hardware not shown to actual size.

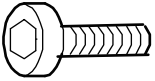

\_\_\_\_\_ AA

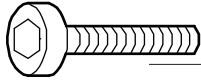

\_\_\_\_\_ BB

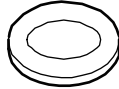

\_\_\_\_\_ CC

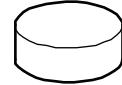

\_\_\_\_\_ DD

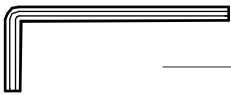

\_\_\_\_\_ EE

Part	Description	Quantity
AA	Bolt (M6x18)	8
BB	Bolt (M6x28)	8
CC	Washer	16
DD	Bolt cap	16
EE	Hex wrench	1

# Pre-Assembly (continued)

## PACKAGE CONTENTS



Part	Description	Quantity
A	Table top	1
B	Table leg	4
C	Leg connector bracket	1

# Assembly

## 1 Attaching the table legs

- Place the table top (A) upside down on a flat, smooth surface.
- Attach the table legs (B) to the table top (A) with washers (CC) and bolts (AA) using the hex wrench (EE).



**IMPORTANT:** Hand tighten the bolts (AA) only. Do not fully tighten until the end of step 2.

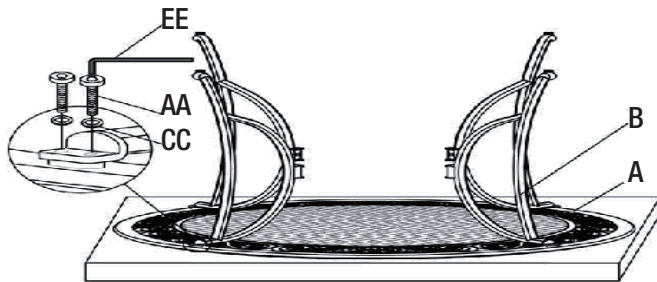

## 2 Attaching the leg connector bracket

- Align the leg connector bracket (C) to the four table legs (B).
- Attach the table legs (B) to the leg connector bracket (C) with washers (CC) and bolts (BB).
- Completely tighten all the bolts (AA and BB) with the hex wrench (EE).

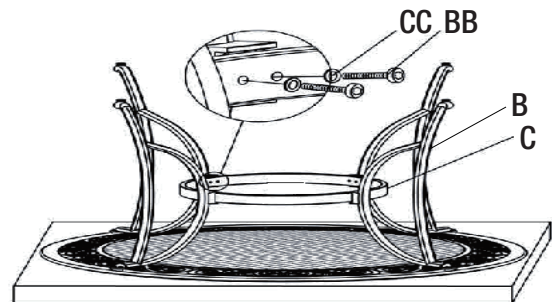

# Assembly

## 3 Attaching the bolt covers

- Cover all the bolts (AA and BB) with bolt caps (DD).

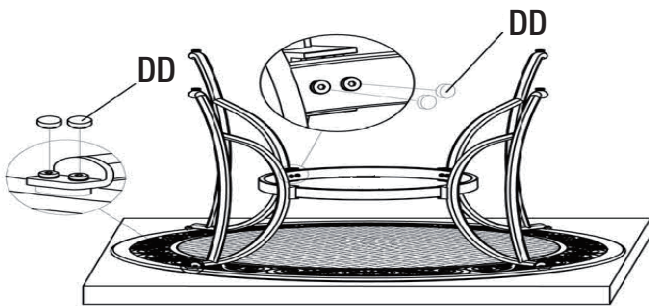

## 4 Leveling the table

- Turn over the table and place it on flat ground.
- When necessary, level the table with the glides at the bottom of the table legs.

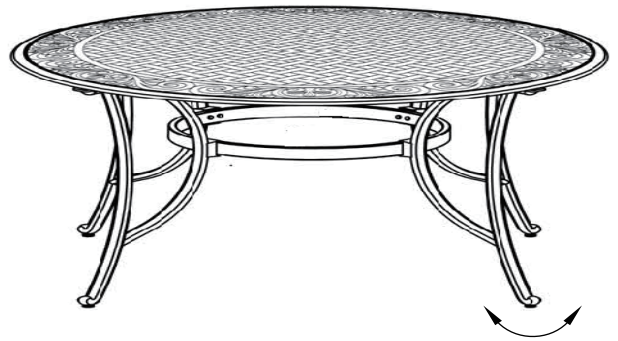



Questions, problems, missing parts? Before returning to the store,  
call Hampton Bay Customer Service  
8.00 a.m. – 6.00 p.m., EST, Monday-Friday

**1-855-HD-HAMPTON**

**HAMPTONBAY.COM**

Retain this manual for future use.